

2016  
**MARINE**  
PARTS AND ACCESSORIES



**AUTOMATIC**  
**DISTRIBUTORS**

[WWW.AUTODIST.COM](http://WWW.AUTODIST.COM)  
207.942.6769 • 800.341.1658

**NEW**

# **AIRHEAD®**

## **WATERSPORTS PRODUCTS**

Airhead inflatables and accessories are made of the highest quality materials in the industry. They pride themselves in building their products with 840 denier nylon covers and 30 gauge PVC bladders, a standard few others can stand behind. If there's a tube shape that can be ridden while towed behind a boat, they make it. If there's a water toy boating enthusiasts are craving, look no further.

### **SUP PADDLEBOARDS**



### **TOWABLES**



### **LOUNGE & PLAY**



SEE THE FULL LINE OF **AIRHEAD®** PRODUCTS INCLUDING BOATS, ROPES, AIR PUMPS, AND MORE IN THE TOWABLES SECTION OF THIS CATALOG.

ACCESSORIES

11-50

TOWABLES

51-138

BODY

139-156

CONTROLS

157-172

ELECTRICAL

173-230

DRIVELINE

231-238

ENGINE

239-288

FUEL & INTAKE

289-318

CHEMICALS

319-386

TIE DOWNS

387-412

TOOLS

413-456

TOWING & LOADING

457-480

**NEW FOR 2016!**

**ACCESSORIES**

**AIRHEAD**

**TREND LIFE VESTS**

page 12



**SUP STABILIZERS AND TRAINING WHEELS**

page 40



**SUP CARRIER**

page 40



page 42



**HEAVY DUTY LEASH**

**SCRUNCHY LEASH & TOW STRAP**



**PADDLE / ROD LEASH**

**NEW FOR 2016!**

**ACCESSORIES**

**AIRHEAD**



**PAWS PAD**

page 43



**SUCTION CUP  
TIE DOWNS**

page 43



**LASHING TABS**

page 43



**AQUA-ZOOKA**

**BIG SHOT  
DOUBLE BIG SHOT**

page 45



**COAST GUARD KITS**

page 41



# NEW FOR 2016!

## TOWABLES

# AIRHEAD



**PFISH SKIM  
STYLE WAKEBOARD**

page 57



**VENOM BINDING**

page 58



**TRAINER  
WATERSKIS**

page 60



**RIPTIDE 2  
RIPTIDE 3**

page 71



**DISC-GO**

page 64



**HOT SHOT**

page 70

**NEW FOR 2016!**

**TOWABLES**

**AIRHEAD**



**STRIKE**

page 72



**QUAD DOG**

page 77

DESIGNER



SERIES



**LAND OR WATER LOUNGERS**

pages 84 & 85



**NEW FOR 2016!**

**TOWABLES**

**AIRHEAD**

**SUN COMFORT**

**WATER FLOATS**

page 86



**SUP PADDLEBOARDS**

pages 89-92



**ORB**

page 95

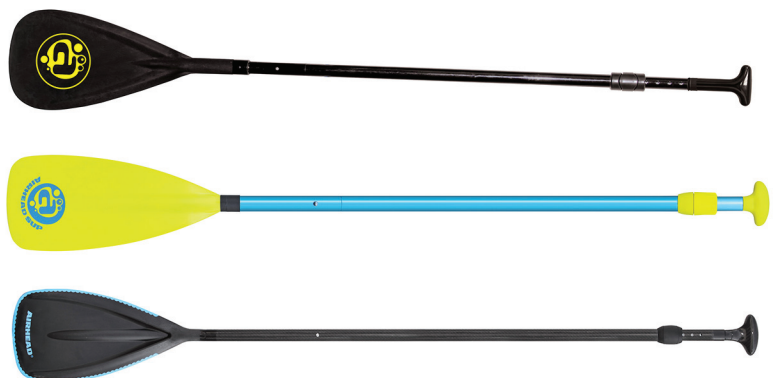

**SUP PADDLES**

page 96



# TOWABLES



**CHARIOT DUO**  
TOWABLE AND LOUNGER

page 111



**POPA WHEELIE**  
**SUPER POPA WHEELIE**

page 112



**BIG BETTY**  
**SERIES**

page 111

**NEW FOR 2016!**

**TOWABLES**



**HIGH ROLLER 2  
HIGH ROLLER 3  
HIGH ROLLER 4**

page 115

**CHEMICALS**



**ULTIMATE  
CORROSION  
PROTECTION**

page 384

**CORROSION BLOCK  
WATERPROOF GREASE**

page 385





# ACCESSORIES

Look to AIRHEAD for the best quality flotation vests your money can buy. Designed for the active lifestyle, with deep necklines and extra large armholes for mobility and comfort. All are subject to strict UL, ULC or CE inspections. ULC vests conform to Canadian Coast Guard requirements and are DOT approved. The materials that we use are the finest available, including UV resistant 200 denier Nylon Oxford, UV resistant 200 denier Polyester, luxurious Neoprene, lightweight and quick drying NeoLite, fashionable NeoSkin, heavy duty ITW Delrin® side release buckles, YKK® zippers, soft PVC foam and lightweight EPE foam. Trust AIRHEAD for all your flotation needs.

### TREND WOMEN'S CLOSED SIDE LIFE VEST

**NEW  
PRODUCT**

- 4 Adjustable Belts
- Closed Sided
- Lightweight EPE Foam
- Adult, over 90 lbs.
- Size: S/M, L/XL, 2XL/3XL, XS
- USCG Approved type III

PART #	MFG #	COLOR	SIZE		
968062	10081-07-A-BKHP	BK/HP	XS	36.99	J
968056	10081-04-A-BKHP	BK/HP	S-M	36.99	J
968058	10081-05-A-BKHP	BK/HP	L-XL	36.99	J
968060	10081-06-A-BKHP	BK/HP	2XL-3XL	36.99	J



### TREND MEN'S CLOSED SIDE LIFE VEST

**NEW  
PRODUCT**

- 4 Adjustable Belts
- Closed Sided
- Lightweight EPE Foam
- Adult, over 90 lbs.
- Size: S/M, L/XL, 2XL/3XL, 4XL/6XL, XS
- USCG Approved type III

PART #	MFG #	COLOR	SIZE		
968063	10081-07-A-BKSB	BK/SB	XS	36.99	J
968057	10081-04-A-BKSB	BK/SB	S-M	36.99	J
968059	10081-05-A-BKSB	BK/SB	L-XL	36.99	J
968061	10081-06-A-BKSB	BK/SB	2XL-3XL	36.99	J
968064	10081-21-A-BKSB	BK/SB	4XL-6XL	39.99	J



### TREND GIRLS CLOSED SIDE LIFE VEST

**NEW  
PRODUCT**

- Adjustable Belts
- Closed Sided
- Lightweight EPE Foam
- Child, 30-50 lbs.
- Youth, 50-90 lbs.
- USCG Approved type III

PART #	MFG #	COLOR	SIZE		
968052	10081-02-A-HPSB	HP/SB	CHILD	24.99	J
968055	10081-03-A-HPSB	HP/SB	YOUTH	29.99	J



### TREND BOYS CLOSED SIDE LIFE VEST

**NEW  
PRODUCT**

- Adjustable Belts
- Closed Sided
- Lightweight EPE Foam
- Child, 30-50 lbs.
- Youth, 50-90 lbs.
- USCG Approved type III

PART #	MFG #	COLOR	SIZE		
968053	10081-02-A-LGBL	LG/BL	CHILD	24.99	J
968054	10081-03-A-BLLG	BL/LG	YOUTH	29.99	J



accessories  
towables  
body  
controls  
electrical  
driveline  
engine  
fuel & intake  
chemicals  
tie downs  
tools  
towing & loading

MARINE

AIRHEAD LIFE VESTS



**AIRHEAD ADULT WATERSPORT COMFORT FLEX NEOPRENE LIFE JACKETS**

Flex Panels on the sides and rear make this the most comfortable PFD of all time! NeoLite construction for light weight and quick drying. Excellent back support 3 - 1 1/2" wide adjustable belts

- Foam: EPE, PVC/EPE or PVC Dual
- Sized: S/M, L/XL, 2XL/3XL
- Unisex

PART #	MFG #	COLOR	SIZE		
966029	10017-04-B-BKSV	BK/SV	S-M	69.99	J
966031	10017-05-B-BKSV	BK/SV	L-XL	69.99	J
966030	10017-06-B-BKSV	BK/SV	2XL-3XL	69.99	J



**AIRHEAD ADULT WATERSPORT NEO/NYLON LIFE JACKETS**

AIRHEAD® manufactures a wide variety of the best quality flotation vests that your money can buy. Ergonomically designed deep necklines and extra large armholes facilitate the mobility you demand for your active lifestyle. All designs and production are subject to strict UL, ULC or CE inspection. Trust AIRHEAD for all your flotation needs.

- 4 Adjustable Belts
- Closed Sided
- Lightweight pvc Foam
- Adult, over 90 lbs.
- Sizes Available: S/M, L/XL, 2X/3X
- USCG Approved type III

PART #	MFG #	COLOR	SIZE		
966026	10014-04-B-BL	BLUE	S-M	49.99	J
966027	10014-05-B-BL	BLUE	L-XL	49.99	J
966028	10014-06-B-BL	BLUE	2XL-3XL	49.99	J



**AIRHEAD UTILITY FLOAT CUSHIONS**

AIRHEAD® manufactures a wide variety of the best quality flotation vests that your money can buy. Ergonomically designed deep necklines and extra large armholes facilitate the mobility you demand for your active lifestyle. All designs and production are subject to strict UL, ULC or CE inspection. Trust AIRHEAD for all your flotation needs.

- Nylon Shell
- Nylon Straps
- Foam PE
- USCG Approved type IV

PART #	MFG #	COLOR		
966005	10001-00-A-BL	BLUE	16.99	J
966007 ☆	10001-00-A-W4	WHITE	16.99	J



- accessories
- towables
- body
- controls
- electrical
- driveline
- engine
- fuel & intake
- chemicals
- tie downs
- tools
- towing & loading

MARINE

## AIRHEAD AIRHEAD LIFE VESTS CONT'D

### AIRHEAD NYLON LIFE JACKETS

AIRHEAD® manufactures a wide variety of the best quality flotation vests that your money can buy. Ergonomically designed deep necklines and extra large armholes facilitate the mobility you demand for your active lifestyle. All designs and production are subject to strict UL, ULC or CE inspection. Trust AIRHEAD for all your flotation needs.

#### ADULT OPEN SIDED

- 3 Adjustable Belts
- Open Sided
- Lightweight EPE Foam
- Size: Universal L-2X Adult
- USCG Approved type III

PART #	MFG #	COLOR	SIZE		
966014	10002-15-A-BL	BLUE	UNIVERSAL	23.99	H
966016	10002-16-A-BL	BLUE	L-2XL	22.99	H
966673	10002-15-A-RD	RED	UNIVERSAL	25.99	L



#### YOUTH OPEN SIDED

- 3 Adjustable Belts
- Open Sided
- Lightweight EPE Foam
- Size: Youth, 50 - 90 lbs.
- USCG Approved type III

PART #	MFG #	COLOR	SIZE		
966011	10002-03-A-BL	BLUE	YOUTH	19.99	J
966012	10002-03-A-RD	RED	YOUTH	19.99	J
966013	10002-03-A-YW	YELLOW	YOUTH	19.99	J



#### CHILD OPEN SIDED

- 3 Adjustable Belts & Leg Strap
- Open Sided
- Lightweight EPE Foam
- Size: Child, 30 - 50 lbs.
- USCG Approved type III

PART #	MFG #	COLOR	SIZE		
966009	10002-02-A-BL	BLUE	CHILD	17.99	H
966010	10002-02-A-RD	RED	CHILD	17.99	H



#### INFANT OPEN SIDED

- 3 adjustable belts & leg strap
- Collar with grab strap
- Foam: PVC or PE
- Size: Infant, under 30 lbs.
- USCG Approved type II

PART #	MFG #	COLOR	SIZE		
966018	10006-01-A-BL	BLUE	INFANT	21.99	H
966020	10006-01-A-RP	ROSE PINK	INFANT	21.99	H



accessories  
towables  
body  
controls  
electrical  
driveline  
engine  
fuel & intake  
chemicals  
tie downs  
tools  
towing & loading

MARINE

## AIRHEAD LIFE VESTS CONT'D



### AIRHEAD NYLON LIFE JACKETS CONTINUED

#### ADULT CLOSED SIDED

- 4 Adjustable Belts
- Closed Sided
- Lightweight EPE Foam
- Adult, over 90 lbs.
- Sizes Available: S/M, L/XL, 2XL/3XL
- USCG Approved type III

PART #	MFG #	COLOR	SIZE		
966023	10010-04-A-BL	BLUE	S-M	34.99	J
966024	10010-05-A-BL	BLUE	L-XL	34.99	J
966025	10010-06-A-BL	BLUE	2XL-3XL	34.99	J



#### YOUTH CLOSED SIDED

- 3 Adjustable Belts
- Closed Sided
- Lightweight EPE Foam
- Youth, 50-90 lbs.
- USCG Approved type III

PART #	MFG #	COLOR	SIZE		
966022	10010-03-A-BLYW	BL/YW	YOUTH	26.99	J



#### CHILD CLOSED SIDED

- 4 Adjustable Belts
- Closed Sided
- Lightweight EPE Foam
- Child, 30-50 lbs.
- USCG Approved type III

PART #	MFG #	COLOR	SIZE		
966021	10010-02-A-BLYW	BL/YW	CHILD	23.99	J



#### PADDLESPORTS VEST

- Micro-Adjustable Neoprene Shoulder Straps
- Comfortable Mesh Side Panels: Black
- Lashing Tab
- Zipper Closure and Adjustable Waist Belt
- Body Material: Nylon or Nylon Ripstop
- Foam: PE, PVC & PE or PVC

PART #	MFG #	COLOR	SIZE		
966639	10043-04-B-BL	BLUE	S-M	59.99	J
966640	10043-05-B-BL	BLUE	L-XL	59.99	J
966641	10043-12-B-BL	BLUE	2XL	59.99	J



#### DELUXE PADDLESPORTS VEST

- 2 Large Pleated Front Pockets
- Micro-Adjustable Neoprene Shoulder Straps
- Comfortable Mesh Side Panels: Black
- Lashing Tab
- Zipper Closure and Adjustable Waist Belt
- Body Material: Nylon, Nylon Ripstop or Cordura
- Foam: PE, PVC & PE or PVC

PART #	MFG #	COLOR	SIZE		
966642	10045-04-C-RD	RED	S-M	59.99	J
966644	10045-12-C-RD	RED	2XL	69.99	J



accessories

towables

body

controls

electrical

driveline

engine

fuel & intake

chemicals

tie downs

tools

towing & loading

MARINE

## AIRHEAD AIRHEAD LIFE VESTS CONT'D

### AIRHEAD NYLON LIFE JACKETS CONTINUED

#### TYPE II KEYHOLE

- Open Sides
- Adjustable 1" belt
- Not for waterskiing, tubing or PWCs
- Foam PE
- USCG Approved type II



PART #	MFG #	COLOR	SIZE		
966614	10000-02-A-OR	ORANGE	CHILD	9.99	H
966002	10000-03-A-OR	ORANGE	YOUTH	11.99	J
966003	10000-15-A-OR	ORANGE	ADULT	12.99	J

### LIFE JACKET STORAGE BAG, HOLDS 4 TYPE II PFDS

Your life jackets will stay clean, and you'll know where to find them with these Life Jacket Storage Bags. They are tailored to fit Type II life jackets or boat cushions. The vinyl-coated fabric resists mold and mildew. There are mesh air vents on 4 sides for fast drying. HOLDS 4 TYPE II PFDS.

- Vinyl coated fabric resists mold and mildew
- Mesh air vents on 4 sides for fast drying
- Zippered for easy access
- 4 adult type II vests (966003) included with part #966004



PART #	MFG #	COLOR	DESCRIPTION		
966509	PFD-4	WHITE	STORAGE BAG ONLY	14.99	J
966004 ☆	10000-20-A-OR	WHITE	STORAGE BAG w/4 ADULT VESTS	61.99	J

### T-BAG T-TOP & BIMINI TOP STORAGE PACKS (HOLDS 4 PFD'S)

T-BAG™ T-Top & Bimini Top Storage Packs  
 T-Bags are specially designed storage packs that easily mount to most T-Tops, bimini tops and pontoon tops. They are designed to hold Type II life jackets and lots of other gear. The main compartment has a nylon zipper for easy access to the life jackets. There are 2 zippered compartments and three mesh pockets to organize your gear. There's also a stretch cord zig-zagging across the bottom for easy access to towels, rain gear or other items. Manufactured from durable 600-denier UV and water-resistant polyester pack cloth. Life jackets not included.  
 PFD-T4: Holds 4 Type II PFD's, 25" W x 20" D x 6" H.  
 PFD-T6: Holds 6 Type II PFD's, 37" W x 20" D x 6" H.



PART #	MFG #	DESCRIPTION		
966716	PFD-T4	T-BAG, T Top Bag, Holds 4 PFDs	59.99	J
966717	PFD-T6	T-BAG, T Top Bag, Holds 6 PFDs	69.99	J

- accessories
- towables
- body
- controls
- electrical
- driveline
- engine
- fuel & intake
- chemicals
- tie downs
- tools
- towing & loading



## CLYMER MARINE REPAIR MANUALS

MAINTENANCE • TROUBLESHOOTING • REPAIR

With over 70 titles, covering inboard, outboard, stern drive and diesel engines, Clymer Marine and PWC manuals remain the #1 source for DIY maintenance, troubleshooting and repair. With step-by-step procedures combined with detailed photography and extensive use of exploded views, Clymer manuals are a must-have tool for the do-it-yourselfer. In addition, Clymer Pro Series Marine manuals provides coverage for many product manufacturers where there is no longer any source of technical information. These manuals feature condensed service data and specifications covering multiple manufacturers and models. They have long been the trusted source for professionals and experienced mechanics.

## CLYMER PERSONAL WATERCRAFT MANUALS

MFG #	DESCRIPTION	YEAR	PART #		
W801	Kawasaki Jet Ski	76-91	274211	34.95	L
W802	Kawasaki Jet Ski	92-94	274212	34.95	L
MFG #	DESCRIPTION	YEAR	PART #		
W819	Polaris Personal Watercraft	92-95	274219	34.95	L
W820	Polaris Personal Watercraft	96-98	274220	34.95	L
MFG #	DESCRIPTION	YEAR	PART #		
W8093	Sea-Doo Water Vehicles	88-96	274216	34.95	L
W810	Sea-Doo Water Vehicles	97-01	274217	34.95	L
MFG #	DESCRIPTION	YEAR	PART #		
W805	Yamaha Water Vehicles	87-92	274213	34.95	L
W806	Yamaha Personal Watercraft	93-96	274214	34.95	L
W807	Yamaha Wave Runner 4 Stroke	02-09	274215	34.95	L
MFG #	DESCRIPTION	YEAR	PART #		
PWV1	PWC Service Manual	80-88	274210	26.95	L

# CLYMER®

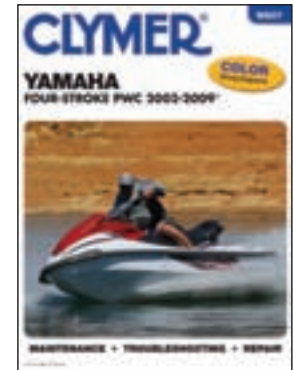
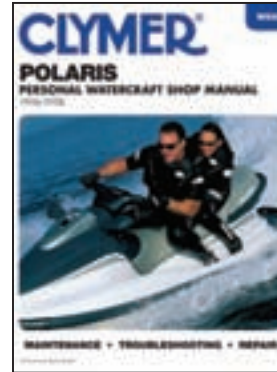

accessories

towables

body

controls

electrical

driveline

engine

fuel & intake

chemicals

tie downs

tools

towing & loading

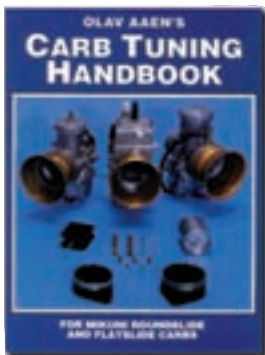

## CARB TUNING HANDBOOK

(INCLUDES 4-STROKE CV CARBS)

Covers the basics in carb tuning, testing and racing. Mikuni's Roundside carbs, Flatside Carbs, and the new TMX are discussed in detail. Learn how to diagnose your carb's performance, use correct testing procedures, and calibrate with the right tools. *Updated in 2001.*

CTH002 30.95 B

## SUDCO MIKUNI TUNING MANUAL

If you work on snowmobiles, motorcycles, dirt bikes, or jet skis you need this book. Complete parts lists, plus instructions and tuning tips. 92 pages of easy to read information.

002-999 13.60 D

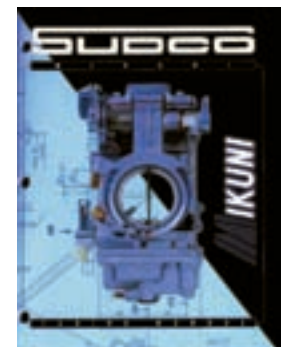

# MARINE

accessories

towables

body

controls

electrical

driveline

engine

fuel & intake

chemicals

tie downs

tools

towing & loading

MARINE

# CLYMER®

## CLYMER MARINE REPAIR MANUALS CONTINUED MAINTENANCE • TROUBLESHOOTING • REPAIR

With over 70 titles, covering inboard, outboard, stern drive and diesel engines, Clymer Marine and PWC manuals remain the #1 source for DIY maintenance, troubleshooting and repair. With step-by-step procedures combined with detailed photography and extensive use of exploded views, Clymer manuals are a must-have tool for the do-it-yourselfer. In addition, Clymer Pro Series Marine manuals provides coverage for many product manufacturers where there is no longer any source of technical information. These manuals feature condensed service data and specifications covering multiple manufacturers and models. They have long been the trusted source for professionals and experienced mechanics.



## CLYMER BOAT MANUALS

MFG #	DESCRIPTION	YEAR	PART #		
BWD1	Wiring Diagrams for OB & IB	56-89	274202	26.95	L
B700	Powerboat Maintenance		274152	34.95	L
IOS6	Inboard/Outdrive Service		274204	26.95	L
IBS3	Inboard Engines & Drives		274203	26.95	L
MMIC3	Motor and Boat Reference	UP TO-96	274205	26.95	L

### INBOARD

MFG #	DESCRIPTION	YEAR	PART #		
B805	Indmar GM v-8 IB	83-03	274201	34.95	L
MFG #	DESCRIPTION	YEAR	PART #		
B742	Mercruiser Stern Drive A1 B1 B2 B3	86-94	274175	34.95	L
B745-2	Mercruiser Stern Drive	98-04	274177	34.95	L
B740	Mercruiser Stern Drive	64-85	274174	34.95	L
B744	Mercruiser Stern Drive	95-97	274176	34.95	L
MFG #	DESCRIPTION	YEAR	PART #		
B738	OMC Cobra Stern Drive	86-93	274172	34.95	L
B739	OMC Cobra SX & DPS	94-00	274173	34.95	L
B730	OMC Stern Drive	64-86	274165	34.95	L
MFG #	DESCRIPTION	YEAR	PART #		
B770	Volvo Stern Drive	68-93	274182	34.95	L
B775	Volvo Penta Stern Drive	01-04	274184	34.95	L
B7712	Volvo Penta Stern Drive	94-00	274183	34.95	L
MFG #	DESCRIPTION	YEAR	PART #		
B787	Yamaha Stern Drive	89-91	274194	34.95	L
MFG #	DESCRIPTION	YEAR	PART #		
B800-2	Yanmar Inboard Engines	80-09	274200	34.95	L

## CLYMER MARINE REPAIR MANUALS CONTINUED MAINTENANCE • TROUBLESHOOTING • REPAIR

With over 70 titles, covering inboard, outboard, stern drive and diesel engines, Clymer Marine and PWC manuals remain the #1 source for DIY maintenance, troubleshooting and repair. With step-by-step procedures combined with detailed photography and extensive use of exploded views, Clymer manuals are a must-have tool for the do-it-yourselfer. In addition, Clymer Pro Series Marine manuals provides coverage for many product manufacturers where there is no longer any source of technical information. These manuals feature condensed service data and specifications covering multiple manufacturers and models. They have long been the trusted source for professionals and experienced mechanics.

# CLYMER®



## CLYMER BOAT MANUALS CONT. OUTBOARD

MFG #	DESCRIPTION	YEAR	PART #	
B750	Chry 3.5-140 HP OB	66-84	274178	34.95 L
MFG #	DESCRIPTION	YEAR	PART #	
B737-2	EJ 85-300 HP Two Stroke	95-02	274171	34.95 L
B734	Evin/Jhnsn 1.5-125 HP OB	56-72	274168	34.95 L
B733	Evin/Jhnsn 2-300 HP OB	91-94	274167	34.95 L
B732	Evin/Jhnsn 2-40 HP OB	73-90	274166	34.95 L
B7352	Evin/Jhnsn 2-70	95-03	274169	34.95 L
B736	Evin/Jhnsn 48-235 HP OB	73-90	274170	34.95 L
MFG #	DESCRIPTION	YEAR	PART #	
B7514	Force OB 4-150HP & L-Drv	84-99	274179	34.95 L
B7572	Hon 4-Stroke OB	76-05	274181	34.95 L
MFG #	DESCRIPTION	YEAR	PART #	
B753	Jhnsn/Evnrnd Four-stroke OB	95-01	274180	34.95 L
MFG #	DESCRIPTION	YEAR	PART #	
B715	Mariner 2.5-275 HP OB	90-93	274156	34.95 L
B714	Mariner 2-220 HP OB	76-89	274155	34.95 L
B712	Merc 4-Stroke OB 75-225hp	01-03	274154	34.95 L
W815	Merc Powered Sport Jet	93-95	274218	34.95 L
MFG #	DESCRIPTION	YEAR	PART #	
B723	Merc/Marnr 2.5-60 HP OB	94-97	274160	34.95 L
B710	Merc/Marnr 4-Stroke OB	95-00	274153	34.95 L
B724	Merc/Marnr 75-275 HP OB	94-97	274161	34.95 L
MFG #	DESCRIPTION	YEAR	PART #	
B721	Mercury 3.5-40 HP OB 72-1989	72-89	274158	34.95 L
B719	Mercury 3.9-135 HP OB 64-1971	64-71	274157	34.95 L
B722	Mercury 3-275 HP OB 90-1993	90-93	274159	34.95 L
B726	Mercury 45-225 HP OB 72-1989	72-89	274163	34.95 L
MFG #	DESCRIPTION	YEAR	PART #	
B727	Mrcry/Mrne 2 strk otbrd 75-250hp		274164	34.95 L
B725	Mrcry/Mrne2 2.5-60hp 1998-02	98-02	274162	34.95 L

MFG #	DESCRIPTION	YEAR	PART #	
OOS1	Old Outboard Motor Service V 1	>1969	274207	26.95 L
OOS2	Old Outboard Motor Service V 2	>1969	274208	26.95 L
MFG #	DESCRIPTION	YEAR	PART #	
OF10	Outboard Motor Flat Rate		274206	26.95 L
OS211	Outboard Motor Svc Vol 2	69-89	274209	26.95 L
MFG #	DESCRIPTION	YEAR	PART #	
B793	Nissa 2-Stroke OB	92-00	274199	34.95 L
MFG #	DESCRIPTION	YEAR	PART #	
B778	Suz 2-Stroke OB 2-65 hp	92-99	274185	34.95 L
B779	Suz 2-Stroke OB 75-22 hp	92-99	274186	34.95 L
B780	Suzuki 2-140 HP OB	77-84	274187	34.95 L
B781	Suzuki 2-225 HP OB & Jt D	85-91	274188	34.95 L
B782	Suzuki 4Strk Otbrd 9.9-70hp	97-00	274189	34.95 L
MFG #	DESCRIPTION	YEAR	PART #	
B790	Tohatsu 2.5-140hp 2-Stroke OB	92-00	274197	34.95 L
MFG #	DESCRIPTION	YEAR	PART #	
B789	Yamaha 115-250 hp 2-Stroke OB	99-02	274196	34.95 L
B783	Yamaha 2-225 HP 2-Stroke OB	84-89	274190	34.95 L
B784	Yamaha 2-250 HP 2-Stroke	90-95	274191	34.95 L
B786	Yamaha 2-Stroke 2-90hp OB	99-02	274193	34.95 L
B785	Yamaha 2-Stroke OB 2-250HP	96-98	274192	34.95 L
B791-2	Yamaha 4strk Otbrd 72-225hp	00-04	274198	34.95 L
B788	Yamaha 9.9-100 HP 4-Stroke OB	85-99	274195	34.95 L

accessories

towables

body

controls

electrical

driveline

engine

fuel & intake

chemicals

tie downs

tools

towing & loading

# MARINE

accessories

towables

body

controls

electrical

driveline

engine

fuel & intake

chemicals

tie downs

tools

towing & loading

MARINE

## KID KARRIER

Keep your child securely attached to the driver. Smaller children fit up front, while larger kids fit on back. 5 point security to keep the child on the machine so that the driver can drive with both hands. The Kid Karrier fits adults from petite to XXXL and allows you to adjust to the desired tension holding child in place.

KG0123 36.95 L

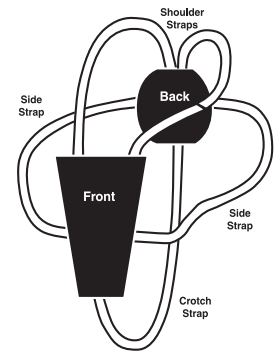

**WARNING!** This product is not intended to protect you or your passenger in the case of an accident. This product should not be used as a carrying device.

## RIDER HOLD-TIGHT™

- Common sense design allows passenger to hold onto driver safely and securely when riding your snowmobile, ATV, motorcycle, or personal watercraft
- Designed to be worn directly over your clothing, life jacket or snowmobile suit
- Dual Position rider handles provide quick and easy handholds
- Ultra comfortable neoprene hand-hold tubes remain soft in cold weather, and provide flotation during marine use
- Constructed of heavy-duty nylon webbing, 500 denier cloth and quick release



PD1070 44.95 G



## PASSENGER GRIP HANDLE

Polyethylene black passenger handle for maximum comfort and safety for passenger.

LP13250 8.95 L



## UNIVERSAL BAR END MIRROR

- Adjustable
- Shock resistant construction
- Left or right reversible
- Black



6212041 14.95 L

## HAND MIRROR

- Solid black only
- Lightweight, 2-1/2" x 3-1/3" convex acrylic safety lens
- Adjustable black velcro strap to keep secure on back of your glove or sleeve so you can see behind you



M25 8.95 L

## HANDLEBAR MIRROR WITH ADJUSTABLE LENS

- 3" round mirror
- Adjustable velcro strap for quick and easy mounting



AM1000 13.95 L

## WRIST MIRROR

- Very popular / low cost safety item.
- Lightweight and convenient.
- Adjustable straps keep this secure.
- Fits over your sleeve or glove.
- 3" round mirror.
- Black only.
- Sold each.



224150 6.95 L

## UNIVERSAL BAR END MIRROR

- Fits left or right. 7/8" handlebar
- Black or chrome
- One per slide pack



COLOR	PART #		
Chrome	EM34000	17.95	L
Black	EM34010	15.95	H

**IEMIGGO**

## TEAR DROP MIRROR

- Mounts on left or right side - universal
- Enlarged ultra clear flat lens provides a great rear view
- Rugged
- Durable
- Holds adjustment
- Solid black
- Sold each
- Lens (flat) measures 3.5 x 6.25
- Sporty styling
- OEM #0639-363



M16 16.95 L

accessories

towables

body

controls

electrical

driveline

engine

fuel & intake

chemicals

tie downs

tools

towing & loading

MARINE

# ACCESSORIES

## 3" LETTER AND NUMBER KITS



- 3" Letters & Numbers (factory matched)
- Complete sets of registration letters & numbers for the ATV, Boat, Watercraft or Snowmobile
- UV coated, fade, fuel & scratch resistant
- 3" legal size
- Each set includes 4 sets of A-Z, 0-9 (total 146 decals) for all 3" kits

### SERIES 200:

The original and still the most popular outline.  
Color shades on body color for that custom air brush look.

PART #	MFG #	DESCRIPTION / COLOR	U/M
HL2001	18.99 L	BLBKG200 3" LETTER & NUMBER KIT BLUE / BLACK	KIT
HL2002	18.99 L	BLKKI200 3" LETTER & NUMBER KIT BLACK /KIWI	KIT
HL2003	18.99 L	BRBKG200 3" LETTER & NUMBER KIT BEIGE /BLACK	KIT
HL2005	18.99 L	PUTEG200 3" LETTER & NUMBER KIT PURPLE / TEAL	KIT
HL2006	18.99 L	REBKG200 3" LETTER & NUMBER KIT RED / BLACK	KIT
HL2007	18.99 L	REPUG200 3" LETTER & NUMBER KIT RED / PURPLE	KIT
HL2008	18.99 L	RUBKG200 3" LETTER & NUMBER KIT BURGUNDY / BLACK	KIT
HL2009	18.99 L	SIBKG200 3" LETTER & NUMBER KIT SILVER / BLACK	KIT
HL2011	18.99 L	WHBKG200 3" LETTER & NUMBER KIT WHITE /BLACK	KIT
HL2012	18.99 L	YEBKG200 3" LETTER & NUMBER KIT YELLOW / BLACK	KIT
HL2013	18.99 L	YEPUG200 3" LETTER & NUMBER KIT YELLOW / PURPLE	KIT
HL2016	22.49 L	CHBKG200 3" LETTER & NUMBER KIT CHROME / BLACK	KIT
HL2020	9.99 L	WHI200EC 3" LETTER & NUMBER KIT SOLID WHITE	KIT
HL2022	9.99 L	BLK200EC 3" LETTER & NUMBER KIT SOLID BLACK	KIT

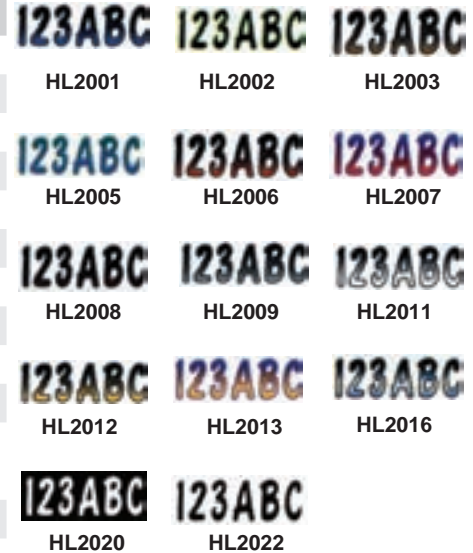

### SERIES 300:

The first and still the best!  
Factory matched carbon fiber look makes a pattern which looks great in any color.

PART #	MFG #	DESCRIPTION / COLOR	U/M
HL3000	18.99 L	WHBKG300 3" CARBON FIBER KITS / WHITE -BLACK	KIT
HL3001	18.99 L	TEBKG300 3" CARBON FIBER KITS / FOREST GREEN - BLACK	KIT
HL3002	18.99 L	SIBKG300 3" CARBON FIBER KITS / SILVER - BLACK	KIT
HL3005	18.99 L	YEBKG300 3" CARBON FIBER KITS / YELLOW - BLACK	KIT
HL3006	18.99 L	REBKG300 3" CARBON FIBER KITS / RED - BLACK	KIT
HL3007	18.99 L	REPUG300 3" CARBON FIBER KITS / RED - BLACK	KIT
HL3008	18.99 L	BLBKG300 3" CARBON FIBER KITS / BLUE - BLACK	KIT
HL3010	22.49 L	CHBKG300 3" CARBON FIBER KITS / CHROME - BLACK	KIT



### SERIES 320 / 350:

Solid body with no shading.  
Contrasting outline with drop shadow in the popular block font.

PART #	MFG #	DESCRIPTION / COLOR	U/M
HL3201	18.99 L	BLKSI320 3" BLOCK LETTER & NUMBER BLACK/ SILVER	KIT
HL3202	18.99 L	REBLK320 3" BLOCK LETTER & NUMBER RED /BLACK	KIT
HL3206	18.99 L	SIBLK320 3" BLOCK LETTER & NUMBER KIT SILVER / BLACK	KIT
HL3500	9.99 L	WHI350EC 3" BLOCK LETTER & NUMBER KIT SOLID WHITE	KIT
HL3502	9.99 L	BLK350EC 3" BLOCK LETTER & NUMBER KIT SOLID BLACK	KIT



- accessories
- towables
- body
- controls
- electrical
- driveline
- engine
- fuel & intake
- chemicals
- tie downs
- tools
- towing & loading

MARINE

## 2" LETTER AND NUMBER KITS

- Most states have guidelines for snowmobile registration for 2" or larger numbers
- Features a unique bevel design for snowmobiles
- Each kit contains 2 sets A-Z and 4 sets of 0-9



PART #	MFG #	DESCRIPTION / COLOR	U/M
HL5000	16.99	L WHI500EC 2" LETTER & NUMBER KIT SOLID WHITE	KIT
HL5002	14.99	L BLK500EC 2" LETTER & NUMBER KIT SOLID BLACK	KIT
HL5003	16.99	L CHBLK500 2" LETTER & NUMBER KIT CHROME / BLACK	KIT
HL5004	16.99	L KIBLK500 2" LETTER & NUMBER KIT GREEN /BLACK	KIT
HL5005	16.99	L REBLK500 2" LETTER & NUMBER KIT RED / BLACK	KIT
HL5006	16.99	L SIBLK500 2" LETTER & NUMBER KIT SILVER / BLACK	KIT
HL5007	16.99	L WHBLK500 2" LETTER & NUMBER KIT WHITE /BLACK	KIT
HL5008	16.99	L BLKKI500 2" LETTER & NUMBER KIT BLACK /GREEN	KIT
HL5009	16.99	L YEBLK500 2" LETTER & NUMBER KIT YELLOW / BLACK	KIT
HL5010	16.99	L YERED500 2" LETTER & NUMBER KIT YELLOW / RED	KIT
HL5011	16.99	L BLKSI500 2" LETTER & NUMBER KIT BLACK /SILVER	KIT



## CUSTOM LETTERING KITS

- 222 pieces
- Sticks to practically any surface
- Easy to apply
- Decals won't wash off
- Exterior or interior use
- UV coated
- Fade, fuel & scratch resistant
- Stylish 1" labels
- For boats, vehicle, sign, snowmobiles and more

- INCLUDES:
- 12: I's
  - 8: A,E,O,T
  - 6: N,R,S,0
  - 4: B,C,D,F,G,H, J,K,L,M, P,Q, U,V,W,X,Y,Z, 0, 1, 2, 3, 4, 5, 6, 7, 8, 9
- Plus various punctuation & symbols

PART #	MFG #	DESCRIPTION / COLOR	U/M
HL2410	9.99	L 2410B 1" LETTER KIT / BLACK WITH RED TRIM	KIT

## STICKER-ON!

- Decal Application Fluid
- No more bubbled or wrinkled decals

PART #	MFG #	DESCRIPTION / COLOR	U/M
HL964	5.95	L 964 STICKER-ON	EA

## STICKER-OFF!

- Decal Adhesive Remover
- Removes messy sticker residue

PART #	MFG #	DESCRIPTION / COLOR	U/M
HL965	5.95	L 965 STICKER-OFF	EA



- accessories
- towables
- body
- controls
- electrical
- driveline
- engine
- fuel & intake
- chemicals
- tie downs
- tools
- towing & loading

MARINE

accessories

towables

body

controls

electrical

driveline

engine

fuel & intake

chemicals

tie downs

tools

towing & loading



## DRY PAK® GPS, PDA, SMART PHONE CASE

DRY PAK GPS / PDA / Smart Phone Case  
Convenient Stylus Holder

- 5 in. wide x 6 in. long
- Clear TPU front, gray TPU back, padded and lined
- Adjustable neck lanyard & anodized aluminum spring hook
- White sealing clip for high visibility
- For beach, pool, boating, paddling, etc.
- Maximum circumference: 9 in.

PART #	MFG #	DESCRIPTION	U/M		
966705	DP-56W	DRY PAK Case, 5 x 6, White/Gray	EA	17.99	L

## DRY PAK® GPS, PDA, GAME PLAYER CASE (5" X 8")

DRY PAK GPS / PDA Game Player Case  
Convenient Stylus Holder

- 5 in. wide x 8 in. long
- Clear TPU front, gray TPU back, padded and lined
- Adjustable neck lanyard & anodized aluminum spring hook
- White sealing clip for high visibility
- For beach, pool, boating, paddling, etc.
- Maximum circumference: 9 in.

PART #	MFG #	DESCRIPTION	U/M		
966706	DP-58W	DRY PAK Case, 5 x 8, White/Gray	EA	19.99	L



## DRY PAK® BELT PACK (6" X 5")

DRY PAK Belt Pack

- 6 in. wide x 5 in. long
- Gray waterproof nylon with waterproof backing
- Adjustable waist belt & anodized belt loop hook
- White sealing clip for high visibility
- For beach, pool, water parks, hiking, snorkeling
- Holds wallets, keys, cameras, personal items
- Maximum circumference: 11 in.

PART #	MFG #	DESCRIPTION	U/M		
966707	DP-65W	DRY PAK Belt Pack, Nylon, 6 x 5 x 3/4, White/Gray	EA	16.99	L







## DRY PAK® VHF RADIO CASE

The VHF Radio Case is made of a strong thermoplastic polyurethane material with padding for protection and a yellow sealing clip for high visibility. The adjustable neck lanyard and anodized aluminum spring hook make it easy to keep track of your radio on your river rafting or water ski trip.

PART #	MFG #	DESCRIPTION	U/M
966434	DP-512	DRY PAK VHF Radio Case, 5 x 12	EA 21.99 L

## DRY PAK® ALLIGATOR WALLET

4 in. wide x 4 in. long. Blue "alligator" embossed TPU front, clear TPU back. Adjustable neck lanyard included. Yellow sealing clip for high visibility. For beach, pool, boating, airports, water parks, hiking, snorkeling. Holds ID, cash, credit cards, keys, pagers. Maximum circumference: 7 1/4 in.

PART #	MFG #	DESCRIPTION	U/M
966429	DP-44	DRY PAK Alligator Wallet, 4 x 6	EA 9.99 L
966703	DP-44W	DRY PAK Alligator Wallet, 4 x 4, White/Gray	EA 9.99 L



## DRY PAK® CELL PHONE CASE

The Cell Phone Case will keep your phone dry and protected on your next water sports adventure. It's perfect for jet skiing, boating, snorkeling, beach, pool and more. The padded and lined TPU case has a stylus holder on the front and comes with an adjustable neck lanyard & anodized aluminum spring hook. The case has a yellow sealing clip for high visibility and maximum circumference of 7 1/4 in.

PART #	MFG #	DESCRIPTION	U/M
966430	DP-46	DRY PAK Cell Phone Case, 4 x 6	EA 15.99 L
966433	DP-48	DRY PAK Cell Phone Case, 4 x 8	EA 16.99 P
966704	DP-47W	DRY PAK Cell Phone Case, 4 x 7, White/Gray	EA 16.99 L



## DRY PAK® FLIP PHONE CASE

4 in. wide x 6 in. long. Frosted TPU outside, clear TPU inside. Adjustable neck lanyard & anodized aluminum spring hook. Yellow sealing clip for high visibility. For beach, pool, boating, snorkeling and more. Patent Pending. Maximum circumference: 7 1/4 in.

PART #	MFG #	DESCRIPTION	U/M
966431	DP-46F	DRY PAK Flip Phone Case, 4 x 6	EA 17.99 R



accessories

towables

body

controls

electrical

driveline

engine

fuel & intake

chemicals

tie downs

tools

towing & loading

MARINE

accessories

towables

body

controls

electrical

driveline

engine

fuel & intake

chemicals

tie downs

tools

towing & loading



## DRY PAK® GPS, POCKET PC CASE

5 in. wide x 6 in. long. Clear TPU front, blue TPU back, padded and lined. Adjustable neck lanyard & anodized aluminum spring hook. Yellow sealing clip for high visibility. For beach, pool, boating, paddling, etc. Maximum circumference: 9 in.

PART #	MFG #	DESCRIPTION	U/M
966435	DP-56	DRY PAK PDA, GPS, Pocket PC Case, 5 x 6	EA 17.99 L

## DRY PAK® BELT PACK WATERPROOF BAG

6 in. wide x 5 in. long. Blue waterproof nylon with waterproof backing. Adjustable waist belt & anodized belt loop hook. Yellow sealing clip for high visibility. For beach, pool, water parks, hiking, snorkeling. Holds wallets, keys, cameras, personal items. Maximum circumference: 11 in.



PART #	MFG #	DESCRIPTION	U/M
966437	DP-65	DRY PAK Belt Pack, Nylon, 6 x 5-3/4	EA 16.99 L

## DRY PAK® CAMERA CASE

6 in. wide x 8 in. long x 2 in. deep. Optically clear TPU. Adjustable camera strap. Yellow sealing clip for high visibility. For beach, pool, boating, water parks. Holds 35mm & digital cameras, etc. Maximum circumference: 11in.



PART #	MFG #	DESCRIPTION	U/M
966439	DP-68C	DRY PAK Camera Case, Clear, 6 x 8 x 2	EA 21.99 L

## DRY PAK® CAMERA CASE W/ ZOOM LENS

Features:

- Compact Design
- Accommodates most zoom lenses
- 4 in. wide x 5.5 in. long
- Clear heavy gauge vinyl
- New slim white clip is less bulky
- For sightseeing, boating, camping, hiking
- Maximum circumference: 7 1/4 in.



PART #	MFG #	DESCRIPTION	U/M
966441	DPC-400	DRY PAK Camera Case w/Zoom Lens, 4 x 5.5	EA 15.99 P

MARINE



accessories

towables

body

controls

electrical

driveline

engine

fuel & intake

chemicals

tie downs

tools

towing & loading

MARINE



### DRY PAK® MULTI-PURPOSE CASE

Take the Multi-Purpose Case along with you on your water sports or camping trips. The 12" x 16" case will protect your maps, charts, laptop, and more. The case is constructed of a clear heavy gauge vinyl with 2 D-rings sewn to the corners and a yellow sealing clip for high visibility. Maximum circumference: 22 in.

PART #	MFG #	DESCRIPTION	U/M
966440	DPC-1216	DRY PAK Multi-Purpose Case, Clear, 12 x 16	EA 18.99 L

### DRY PAK® MULTI-PURPOSE CASE

The Multi-Purpose Case is 9" wide by 12" long. Made of clear heavy gauge vinyl with 2 D-rings sewn to the corners, the case is perfect for jet skiing, wake boarding, water sports, camping and hiking. The high visibility yellow sealing clip will ensure that your manuals, snacks, electronics, and other items are stored safely. Maximum circumference: 17 in.

PART #	MFG #	DESCRIPTION	U/M
966443	DPC-912	DRY PAK Multi-Purpose Case, Clear, 9 x 12	EA 15.99 L



### DRY PAK® MULTI-PURPOSE CASE

6 in. wide x 9 in. long. Clear heavy gauge vinyl. 2 D-rings sewn to corners. Yellow sealing clip for high visibility. For paddling, boating, camping, hiking. Holds wallets, registrations, maps, electronics, cameras, etc. Maximum circumference: 11 in.

PART #	MFG #	DESCRIPTION	U/M
966442	DPC-69	DRY PAK Multi-Purpose Case, Clear, 6 x 9	EA 13.99 L



### DRY PAK® NYLON PACK

12 in. wide x 16 in. long x 4 in. deep. Rugged waterproof nylon, padded & lined. Convenient mesh pocket. Adjustable shoulder strap. Yellow sealing clip for high visibility. For beach, pool, boating, water parks, camping, paddling. Holds & protects lots of gear. **966452** maximum circumference: 22 in. **966453** maximum circumference 17 in.

PART #	MFG #	DESCRIPTION	U/M
966452	DPG-1216	DRY PAK Multi-Purpose Nylon Case, 12 x 16 x 4	EA 36.99 J
966453	DPG-912	DRY PAK Multi-Purpose Nylon Case, 9 x 12 x 3	EA 31.99 J



accessories

towables

body

controls

electrical

driveline

engine

fuel & intake

chemicals

tie downs

tools

towing & loading

MARINE



## DRY PAK® CELL PHONE CASE

- 4 in. wide x 8 in. long
- Clear TPU front, gray TPU back, padded and lined
- Adjustable neck lanyard & anodized aluminum spring hook
- White sealing clip for high visibility
- For beach, pool, boating, snorkeling and more
- Maximum circumference: 7 1/4 in



PART #	MFG #	DESCRIPTION	U/M
966645	DP-48W	DRY PAK Cell Phone Case, 4 x 8, White/Gray	EA 16.99 L

## DRY PAK® CAMERA CASE

- Shoot Pictures Through the Case!
- 6 in. wide x 5 in. long x 1 1/2 in. deep
- Optically clear TPU
- Adjustable camera strap
- White sealing clip for high visibility
- For beach, pool, boating, water parks
- Holds 35mm & digital cameras, etc.
- Maximum circumference: 11 in.



PART #	MFG #	DESCRIPTION	U/M
966646	DP-65CW	DRY PAK Camera Case, Clear, 6 x 5 x 1 1/2	EA 17.99 L



## DRY PAK® CLEAR TABLET CASE (6" x 10")

- Listen to Music or movies with built-in Ear Phone Jack!
- 6 in. wide x 10 in. long
- Clear heavy gauge vinyl
- Designed to protect electronic touch pads and other tablets from the elements
- View and operate touch pads and tablets through the case with ease!
- White sealing clip for high visibility
- Integrated female jack RF welded at the bottom
- For paddling, boating, camping, hiking
- Holds electronic touch pads, owners manuals, snacks, maps, etc.
- Maximum circumference: 11 in.

PART #	MFG #	DESCRIPTION	U/M
966647	DPT-610W	DRY PAK Tablet Case, For Kindle, Galaxy	EA 27.99 L

## DRY PAK® CLEAR TABLET CASE (9" x 12")

- Listen to Music or movies with built-in Ear Phone Jack!
- 9 in. wide x 12 in. long
- Clear heavy gauge vinyl
- Designed to protect electronic touch pads and other tablets from the elements
- View and operate touch pads and tablets through the case with ease!
- White sealing clip for high visibility
- Integrated female jack RF welded at the bottom
- For paddling, boating, camping, hiking
- Holds electronic touch pads, owners manuals, snacks, maps, etc.
- Maximum circumference: 17 in.



PART #	MFG #	DESCRIPTION	U/M
966648	DPT-912W	DRY PAK Tablet Case, For iPad	EA 32.99 L



## DRY PAK® CELL PHONE, GPS, MP3 CASE

- New slim white clip is less bulky
- 4 in. wide x 6 in. long
- Clear TPU front, gray TPU back, padded and lined
- Adjustable neck lanyard & anodized aluminum spring hook
- For beach, pool, boating, snorkeling and more
- Maximum circumference: 7 1/4 in.

PART #	MFG #	DESCRIPTION	U/M
966432	DP-46W	DRY PAK Cell Phone, GPS, MP3 Case, 4 x 6	EA 16.99 L



## DRY PAK® WATERPROOF MP3 CASE

- Waterproof Earbuds Included!
- Perfect for active lifestyles
- Designed to protect iPod's , MP3 players and Cell Phones with players, from the elements.
- View and operate MP3 players through the case with ease!
- Armband, lanyard and spring clip included!
- Durable TPU construction
- Integrated female jack RF welded at the bottom
- For beach, pool, boating, snorkeling and more
- Maximum circumference: 6 in.

PART #	MFG #	DESCRIPTION	U/M
966454	DP-MP31	DRY PAK Waterproof MP3 Case w/earbuds	EA 39.99 J

## DRYPAK® ROLL TOP DRY BAG

Versatile and durable, your gear will stay dry inside these round bottom dry bags, even in adverse conditions. Shut out water by rolling down the top a few times and snapping the side release buckles together. The yellow and blue bags are constructed of extra heavy-duty vinyl /polyester tri-laminate with RF-welded seams. It's quick and easy to find items inside the clear bags, made of durable waterproof 18 oz. vinyl with RF-welded seams. Great for power boats, sail boats, personal watercraft, kayaks, canoes, camping, motorcycles, ATVs, snowmobiles and car top luggage racks too!

PART #	MFG #	DESCRIPTION	U/M
966547	WB-1	DRY PAK Roll Top Dry Gear Bag, 9.5" x 16", Yellow	EA 12.99 J
966615	WB-4	DRY PAK Roll Top Dry Gear Bag, 11.5" x 19", Yellow	EA 15.99 J
966553	WB-7	DRY PAK Roll Top Dry Gear Bag, 12.5" x 28", Yellow	EA 21.99 J
966548	WB-2	DRY PAK Roll Top Dry Gear Bag, 9.5" x 16", Blue	EA 12.99 J
966551	WB-5	DRY PAK Roll Top Dry Gear Bag, 11.5" x 19", Blue	EA 15.99 J
966554	WB-8	DRY PAK Roll Top Dry Gear Bag, 12.5" x 28", Blue	EA 21.99 J



accessories

towables

body

controls

electrical

driveline

engine

fuel & intake

chemicals

tie downs

tools

towing & loading

MARINE

accessories



towables

body

controls

electrical

driveline

engine

fuel & intake

chemicals

tie downs

tools

towing & loading

## DRY PAK® GPS / PDA GAMEBOY® CASE

Convenient Stylus Holder

- 5 in. wide x 8 in. long
- Clear TPU front, blue TPU back, padded and lined
- Adjustable neck lanyard & anodized aluminum spring hook
- Yellow sealing clip for high visibility
- For beach, pool, boating, paddling, etc.
- Maximum circumference: 9 in.



PART #	MFG #	DESCRIPTION	U/M
966436	DP-58	DRY PAK PDA, GPS, Pocket PC Case, 5 x 8	EA 19.99 L

## DRY PAK® CAMERA CASE

Shoot Pictures Through the Case!

- 6 in. wide x 5 in. long x 1 1/2 in. deep
- Optically clear TPU
- Adjustable camera strap
- Yellow sealing clip for high visibility
- For beach, pool, boating, water parks
- Holds 35mm & digital cameras, etc.
- Maximum circumference: 11 in.



PART #	MFG #	DESCRIPTION	U/M
966438	DP-65C	DRY PAK Camera Case, Clear, 6 x 5 x 1 1/2	EA 17.99 P

## DRY PAK® ROLL TOP DRY BAGS

Versatile and durable, your gear will stay dry inside these round bottom dry bags, even in adverse conditions. Shut out water by rolling down the top a few times and snapping the side release buckles together. The yellow and blue bags are constructed of extra heavy-duty vinyl /polyester tri-laminate with RF-welded seams. It's quick and easy to find items inside the clear bags, made of durable waterproof 18 oz. vinyl with RF-welded seams. Great for power boats, sail boats, personal watercraft, kayaks, canoes, camping, motorcycles, ATV's, snowmobiles and car top luggage racks too!



PART #	MFG #	DESCRIPTION	U/M
966549	WB-3	DRY PAK Roll Top Dry Gear Bag, 9.5" x 16, Clear	EA 12.99 J
966552	WB-6	DRY PAK Roll Top Dry Gear Bag, 11.5" x 19, Clear	EA 15.99 J
966555	WB-9	DRY PAK Roll Top Dry Gear Bag, 12.5" x 28", Clear	EA 21.99 J

966549  
966552

966555



- accessories
- towables
- body
- controls
- electrical
- driveline
- engine
- fuel & intake
- chemicals
- tie downs
- tools
- towing & loading



## DRY PAK® WATERPROOF DUFFELS LARGE

Zippered duffels are water resistant at best. These roll top Dry Pak duffels take waterproof to a whole new level. Shut out water by rolling down the top a few times and snapping the side release buckles together. Unroll and open to enjoy the huge tapered access opening on top. Items are easy to pack and easy to retrieve. There's a convenient water resistant zippered pocket with storm flap on each side, one clear, one opaque. Quality manufactured from extra heavy-duty vinyl/polyester laminate with electronically welded seams; there are no leaky sewn seams to seal. The molded bottom adds structure and protection to contents. The high end plastic hardware ensures long life. The shoulder strap is removable and adjustable for convenience. Great for boating, paddlesports, camping and scent proof storage for hunting. Large (24 x 12 x 12 in. closed, 4,270 cu. In. / 70 liter)

PART #	MFG #	DESCRIPTION	U/M
966444	DP-D1BK	DRY PAK Waterproof Duffel, LG, Black	EA 59.99 J
966445	DP-D1BL	DRY PAK Waterproof Duffel, LG, Blue	EA 59.99 J
966446	DP-D1CL	DRY PAK Waterproof Duffel, LG, Clear	EA 59.99 J
966447	DP-D1GR	DRY PAK Waterproof Duffel, LG, Green	EA 59.99 J

## DRY PAK® WATERPROOF DUFFELS, EXTRA LARGE

Zippered duffels are water resistant at best. These roll top Dry Pak duffels take waterproof to a whole new level. Shut out water by rolling down the top a few times and snapping the side release buckles together. Unroll and open to enjoy the huge tapered access opening on top. Items are easy to pack and easy to retrieve. There's a convenient water resistant zippered pocket with storm flap on each side, one clear, one opaque. Quality manufactured from extra heavy-duty vinyl/polyester laminate with electronically welded seams; there are no leaky sewn seams to seal. The molded bottom adds structure and protection to contents. The high end plastic hardware ensures long life. The shoulder strap is removable and adjustable for convenience. Great for boating, paddlesports, camping and scent proof storage for hunting. Extra Large (30 x 14 x 15 in. closed, 6,712 cu. In., 110 liter)

PART #	MFG #	DESCRIPTION	U/M
966448	DP-D2BK	DRY PAK Waterproof Duffel, XL, Black	EA 69.99 J
966449	DP-D2BL	DRY PAK Waterproof Duffel, XL, Blue	EA 69.99 J
966451	DP-D2GR	DRY PAK Waterproof Duffel, XL, Green	EA 69.99 J
966619	DP-D2CL	DRY PAK Waterproof Duffel, XL, Clear	EA 69.99 J



MARINE

accessories

towables

body

controls

electrical

driveline

engine

fuel & intake

chemicals

tie downs

tools

towing & loading

## PWC SAND ANCHOR



A sand anchor is ideal for anchoring PWCs in shallow water to keep the impeller off the beach. Fill this super durable tri-laminate anchor bag with up to 35 pounds of rocks or sand. A buoy marks the anchor's location. Tie-ups are easy with the 6-foot long rope and the oversized finish-friendly acetyl snap hook.



PART #	MFG #	DESCRIPTION	U/M
966133	A-1	Sand Anchor, 0.8 lbs, 7.88"L x 3.25"H x 5.63"W	EA 21.99 J



## SCREW ANCHOR SYSTEM

Perfect for anchoring a PWC in shallow water, just off the beach. Screw the zinc-plated anchor into compacted sand or mud in 2 to 3 ft. of water. There's a giant nylon snap hook at each end of the 8 ft. long marine grade rope. Snap one to the screw anchor and the other to your PWC or small boat. A padded nylon storage case protects watercraft and dampens noise while stowed.

PART #	MFG #	DESCRIPTION	U/M
966136	A-3	Screw Anchor, 1.4 lbs, 22.5"L x 4.25"H x 7.75"W	EA 24.99 J



## PWC FLUKE ANCHOR



This vinyl-dipped fluke anchor weighs only 1-3/4 pounds, and won't scratch finishes. Perfect for temporary mooring of PWC and other small craft, a 25 foot marine-grade rope is spliced to it. A sturdy nylon case is also included for convenient storage.

PART #	MFG #	DESCRIPTION	U/M
966137	A-5	PWC Fluke Anchor, Nylon Bag, Rope	EA 31.99 J



## COMPLETE GRAPNEL ANCHOR SYSTEM

This complete anchor system is in a class by itself. The 3-1/3 pound 4-fluke folding anchor will hold in mud, sand, gravel and rock. It's designed for temporary mooring of small boats, sailboats, personal watercraft, inflatable boats, canoes and float tubes. The anchor is coated to protect finishes. The durable nylon storage case is padded for added protection and to dampen noise while the anchor is stowed. Fits under most boat seats, in PWC storage compartments, or in PWC storage canisters! The 25 ft. long marine-grade rope, with an in-line buoy, is spliced to the anchor and a heavy-duty stainless steel snap hook.

PART #	MFG #	DESCRIPTION	U/M
966134	A-2	Complete Grapnel Anchor System	EA 41.99 G



## TUBE ANCHOR



Turn your towable into a portable swim platform with AIRHEAD's Tube Anchor. While the kids are lounging or playing on the tube, adults get to enjoy a little quiet time on the boat, dock or beach! AIRHEAD's Tube Anchor bag is constructed of durable reinforced PVC/polyester tri-laminate. Simply fill it with rocks or sand and drop it into the water. The buoy has a convenient mesh compartment inside for stowing slack from the 20 foot long rope. A giant acetyl snap hook allows for easy hook ups to your tube's handle or tow strap.

PART #	MFG #	DESCRIPTION	U/M
966141	AHAT-1	Tube Anchor, 1.31 lbs, 6.5"L x 3.5"H x 9.5"W	EA 17.99 J

MARINE





## ULTIMATE LANYARD

The Ultimate PWC lanyard has it all! 4 keys to fit ALL brands: Sea Doo, Yamaha, Kawasaki, Honda, Polaris, Tiger Shark and Wet Jet. A stainless steel key ring is also included for hooking up to Sea Doo D.E.S.S. devices or a car key. We call it "Ultimate Lanyard" because it has a comfortable floating detachable wrist band, floating vest lanyard and high pitch pea-less whistle for emergencies. A swivel snap hook keeps the cord from tangling. No accessories to buy for this lanyard!

PART #	MFG #	DESCRIPTION	U/M
966542	UL-1	Ultimate Lanyard, Purple / Yellow, for PWCs	EA 18.99 J
966543	UL-2	Ultimate Lanyard, Red / Black, for PWCs	EA 18.99 J
966544	UL-3	Ultimate Lanyard, Blue / Silver, for PWCs	EA 18.99 J

## WHISTLE WITH LANYARD

An audible signal device is required on boats and personal watercraft in most states. A high pitch pealess whistle is a good choice. Clip it onto your life jacket or safety lanyard. Doubles as a floating key chain!

PART #	MFG #	DESCRIPTION	U/M
966545	W-1	Whistle with Lanyard, Purple / Yellow	EA 4.99 J
966546	W-2	Whistle with Lanyard, Red / Black	EA 4.99 J



## PWC TOW STRAP WITH MESH BAG

Perfect for emergencies and handy to stow, this bright yellow floating tow strap includes a mesh bag with drawstring and cord lock. There's a 10" loop at each end and one integrated detachable stainless steel carabiner. Towing watercraft with recessed bow eyes is easy with this Tow Strap. 15 ft. long.

PART #	MFG #	DESCRIPTION	U/M
966541	TS-15	PWC Tow Strap with SST Hook & Mesh Bag	EA 14.99 N

## TOW ROPE

This 20 ft. tow rope has a heavy-duty carabiner at each end. The 12" long "soft hook" is perfect for easy hook-ups to recessed bow eyes and doubles as a rope wrap for neat storage. The 3/8" diameter purple/yellow/red rope is UV, mold and mildew resistant and color coordinates nicely with most PWCs and jet boats.

PART #	MFG #	DESCRIPTION	U/M
966539	TR-20	Tow Rope, 20', 2 Hooks, Rope Keeper	EA 12.99 J



- accessories
- towables
- body
- controls
- electrical
- driveline
- engine
- fuel & intake
- chemicals
- tie downs
- tools
- towing & loading



- accessories
- towables
- body
- controls
- electrical
- driveline
- engine
- fuel & intake
- chemicals
- tie downs
- tools
- towing & loading

## PWC FENDERS

Personal watercraft require specialized fenders to prevent damage from floating underneath docks designed for boats. These 3" x 18" fenders have nylon covers and attach to PWCs with 2 giant suction cups or secure under your hood and seat. Great for docking, rafting boat to boat, PWC to boat, or PWC to PWC. 2 per Package. Color: Black.



PART #	MFG #	DESCRIPTION	U/M
966517	SB-4	PWC Fenders, 2 pack, Black	EA 19.99 J



## IMPELLER PROTECTOR

Keep ski ropes away from your PWC's impeller and protect passengers from ski rope kick-back. Simply run your ski or tube rope through the middle of the impeller protector. Then attach the rope and straps to your ski tow eye. Black nylon covers the 24" long closed cell foam tube.

PART #	MFG #	DESCRIPTION	U/M
966497	IP-24	Impeller Protector PWC Shock Tube, 24"	EA 14.99 J

MARINE

## PERSONAL WATERCRAFT COVER TIE DOWN KIT

Whether your cover has tie down loops or not, it will be ready for trailering down the highway with this one-size-fits-all tie down kit. The side release buckles are perfect for quick and easy covering, removing and tightening. For covers with loops, you'll run the straps under the belly of the personal watercraft and the straps will stay attached to the cover even when you remove it. For covers without loops, the tie down straps go up over the top and are anchored by 4 specially-designed hooks that fit under the side rails. 1 pair per package, includes 4 heavy-duty straps, 2 side release buckles, 4 strap retainers and 4 hooks.



PART #	MFG #	DESCRIPTION	U/M
966537	TD-2	Personal Watercraft Cover Tie Downs, pair	PR 12.99 V



## CONTOUR FENDERS, 24" LONG X 2-1/2" THICK

Traditional round fenders tend to roll up, leaving your boat unprotected. They're also bulky to stow. Boats with step-down gunwales are especially vulnerable to damage from docks. HULL HUGR Contour Fenders stay put and stow conveniently under boat seats. They hinge to wrap around the gunwale and hull, following the contours of the boat. All HULL HUGRs are constructed of an durable marine grade tri-laminate cover, with closed cell foam inside. There's a tough polycarbonate grommet at each end for hanging from cleats.

PART #	MFG #	DESCRIPTION	U/M		
966475	HH-1C	HULL HUGR Contour Fender, Blue	EA	12.99	J
966477	HH-1CW	HULL HUGR Contour Fender, White	EA	12.99	J
966476	HH-1CB	HULL HUGR Contour Fender, Black	EA	12.99	J



## CONTOUR FENDERS, 30" X 6" X 4"

Traditional round fenders tend to roll up from contact with docks, leaving your boat unprotected. They're also bulky to stow. Boats with step-down gunwales are especially vulnerable to damage from docks. HULL HUGR Contour Fenders stay put and stow conveniently under boat seats. They hinge to wrap around the gunwale and hull, following the contours of the boat. All HULL HUGRs are constructed with a tough marine grade rip proof tri-laminate cover, with closed cell foam inside. Durable polycarbonate grommets at each end allow you to hang them from cleats.

PART #	MFG #	DESCRIPTION	U/M		
966483	HH-30C	HULL HUGR Contour Fender, 30" x 6" x 4", Blue	EA	24.99	J
966485	HH-30CW	HULL HUGR Contour Fender, 30" x 6" x 4", White	EA	24.99	J
966484	HH-30CB	HULL HUGR Contour Fender, 30" x 6" x 4", Black	EA	24.99	J



## FLAT FENDER

You'll really appreciate how the HULL HUGR Flat Fender stays put, unlike round fenders that roll up leaving your boat unprotected. They're also more compact, so they're much easier to stow under boat seats. The Hull Hugr Flat Fender is 26" long x 6" wide x 2 1/2" thick. It's constructed of durable marine grade tri-laminate with a polycarbonate grommet at each end. Hang them vertically or horizontally. Great for mounting to docks and posts too!

PART #	MFG #	DESCRIPTION	U/M		
966473	HH-1	HULL HUGR Flat Fender, Blue	EA	12.99	J
966478	HH-1W	HULL HUGR Flat Fender, White	EA	12.99	J
966474	HH-1B	HULL HUGR Flat Fender, Black	EA	12.99	J

- accessories
- towables
- body
- controls
- electrical
- driveline
- engine
- fuel & intake
- chemicals
- tie downs
- tools
- towing & loading

MARINE



- accessories
- towables
- body
- controls
- electrical
- driveline
- engine
- fuel & intake
- chemicals
- tie downs
- tools
- towing & loading



## MODULAR EVA FENDERS

These HULL HUGR Fenders are easy to stow and will not puncture or absorb water. The flat design prevents from them from rolling or riding up. Link 2 or more together with the hook and loop straps provided. Manufactured from 3 layer dual density EVA. They're great for rafting 2 boats together and very popular for sailboats and runabouts. Hook & Loop Strap and Fender Line included.

PART #	MFG #	DESCRIPTION	U/M		
966708	HH-20BL	HULL HUGR Modular EVA Fender, 20 x 8 x 2 in., Blue	EA	19.99	J
966709	HH-20GR	HULL HUGR Modular EVA Fender, 20 x 8 x 2 in., Gray	EA	19.99	J
966481	HH-24BL	HULL HUGR Modular EVA Fender, 24 x 12 x 3 in., Blue	EA	41.99	J
966482	HH-24GR	HULL HUGR Modular EVA Fender, 24 x 12 x 3 in., Gray	EA	41.99	J
966486	HH-36BL	HULL HUGR Modular EVA Fender, 36 x 12 x 3 in., Blue	EA	62.99	J
966487	HH-36GR	HULL HUGR Modular EVA Fender, 36 x 12 x 3 in., Gray	EA	62.99	J

## PWC FENDER

Docking a PWC has never been safer with the introduction of the HULL HUGR PWC Fender. Engineered specifically for PWCs, it hinges in the center to better protect PWC bodies from docks designed for bigger boats. It hooks under the rub rail with a molded acetyl hook integrated into the back of the fender. If your PWC has them, you'll want to connect the top of the fender to a cleat or ski eye with the adjustable strap and vinyl dipped steel hook provided. If not, simply thread the strap through the rubber block provided and place it inside the PWC's storage compartment, then shut it. The block anchors the fender strap perfectly and will not damage the body. We recommend 2 fenders per PWC. Fits all PWCs.



PART #	MFG #	DESCRIPTION	U/M		
966494	HH-P1B	HULL HUGR PWC Fender, Black	EA	20.99	J

## NO-SLIP FENDER STRAPS

No more tying and untying knots! Attach boat fenders to rails and cleats quickly and securely with these fender straps. The NO-SLIP? pads sewn to the underside of the straps minimize sliding along rails. Easily adjust the length in seconds from 6 in. to 40 in. to fit most boats and docking situations. Color: White. 2 per package.



PART #	MFG #	DESCRIPTION	U/M		
966523	SF-2	No-Slip Fender Straps, 2 pack	EA	7.99	J

## SUCTION CUP FENDER STRAPS

Attach your boat fenders exactly where you need the protection. Giant 3-1/4" suction cups attach to gelcoat or windshields quickly and easily. Perfect for most boats and personal watercraft where cleats never seem to be where you need them. Durable 1" wide straps adjust up to 24" long. Fenders not included. 2 per package.

PART #	MFG #	DESCRIPTION	U/M		
966522	SF-1C	Suction Cup Fender Straps, 2 pack	EA	9.99	J





## DOCK BUMPERS

### DOCK BUMPER, CORNER

These dock corner bumpers are manufactured from UV-resistant and tear-proof vinyl/polyester tri-laminate, filled with high-density closed-cell polyethylene foam. There are 4 corrosion-proof polycarbonate grommets, 1 in each corner, for mounting to docks. White.

PART #	MFG #	DESCRIPTION	U/M		
966489	HHB-C1W	HULL HUGR Dock Bumper, Corner 10" x 10" x 4" x 2 1/2"	EA	12.99	J
966714	HHB-C2W	HULL HUGR Dock Bumper, Corner 12 x 12 x 6 x 4	EA	27.99	J

### DOCK BUMPER, 24" X 5" X 2.5"

All HULL HUGR products are manufactured from a UV-resistant and tear-proof vinyl / polyester tri-laminate. These dock bumpers are 24" x 4" x 2 1/2" and are filled with high-density closed-cell polyethylene foam. There are 4 corrosion-proof polycarbonate grommets for mounting to docks. White.

PART #	MFG #	DESCRIPTION	U/M		
966488	HHB-24W	HULL HUGR Dock Bumper, 24" x 5" x 2.5"	EA	12.99	J
966713	HHB-36W	HULL HUGR Dock Bumper, 36" x 6" x 4"	EA	29.99	J



accessories

towables

body

controls

electrical

driveline

engine

fuel & intake

chemicals

tie downs

tools

towing & loading

## MARINA BUMPERS

These heavy duty commercial grade bumpers are great for commercial marinas and personal docks. They're manufactured from UV and tear resistant vinyl / polyester tri-laminate and are filled with high-density closed-cell foam. The stainless steel grommets are spaced along the full length of each bumper for secure mounting to docks. They're 8" wide by 6" deep to provide extravagant protection to all boats. Available in 3 lengths 36", 48", & 60". White.

PART #	MFG #	DESCRIPTION	U/M		
966710	HH-A36	HULL HUGR Marina Bumper - 36"	EA	54.99	J
966711	HH-A48	HULL HUGR Marina Bumper - 48"	EA	69.99	J
966712	HH-A60	HULL HUGR Marina Bumper - 60"	EA	79.99	J



MARINE



- accessories
- towables
- body
- controls
- electrical
- driveline
- engine
- fuel & intake
- chemicals
- tie downs
- tools
- towing & loading



## BUOYS, 20"

The affordable alternative! These durable 20" diameter inflatable buoys are perfect for marking anchors, moorings, hazards, and swimming areas. Great for setting up a personal watercraft or sailboat race course. Deflate them for space-efficient storage.

PART #	MFG #	DESCRIPTION	U/M
966420	B-20R	Buoy, 20", Red	EA 19.99 J
966421	B-20Y	Buoy, 20", Yellow	EA 19.99 J

## FLOATS, 5" X 3"

These durable ultrasonically welded plastic floats are great for pools, ski ropes, anchor lines, marker buoys and crab traps. They're economically priced, yet built to last. Size: 5 inches long x 3 inches diameter with a 1/2-inch hole in the center.

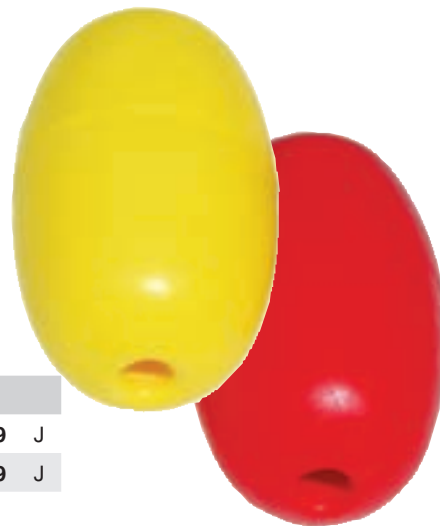

PART #	MFG #	DESCRIPTION	U/M
966462	F-5R	Float, 5" x 3", Red	EA 3.49 J
966463	F-5Y	Float, 5" x 3", Yellow	EA 3.49 J



## FIRST AID KIT, WATERPROOF

You'll always know where to find your First Aid Kit, and the contents will be clean and dry. Easily mounts to boats, personal watercraft, cars, trucks, RV's, cabinets, toolboxes or almost anywhere with self-adhesive hook & loop. The heavy-duty nylon bag is specially coated and has a waterproof zipper to ensure that your first aid supplies stay dry. Doctor-selected contents for a day trip on the water.

PART #	MFG #	DESCRIPTION	U/M
966464	FAK-2	First Aid Kit, Waterproof, Hook & Loop Mount	EA 19.99 J

MARINE

## BOAT KILL SWITCH KEYS WITH LANYARD

Be Prepared, Always Carry a Spare! If you lose or break your kill switch key, for whatever reason, you won't be able to start your engine. Most marinas don't stock replacement keys, so your much-deserved day out on the boat will be ruined. This lanyard has 7 keys to fit all BRP, Johnson, Evinrude, Mercury, Yamaha, Honda, Tohatsu, Nissan and Suzuki kill switches. It's equipped with a swivel snap hook to prevent tangles, and rust-free stainless steel crimps. Don't leave the dock without it!



PART #	MFG #	DESCRIPTION	U/M
966423	BKS-6	Boat Kill Switch Keys with Lanyard	EA 12.99 J

- accessories
- towables
- body
- controls
- electrical
- driveline
- engine
- fuel & intake
- chemicals
- tie downs
- tools
- towing & loading



## RESCUE THROW BAG

You'll be astonished how easy it is to throw this 50 ft. rescue line with incredible accuracy to a swimmer in trouble. Keep LIFE LINE accessible by hanging it from a boat rail or other convenient spot with the integrated strap with side release buckle. Easy to understand and implement directions with graphics are printed on the outside. Constructed of rugged bright orange, UV-resistant 600-denier polyester. Great for snowmobiles on frozen lakes too!

PART #	MFG #	DESCRIPTION	U/M		
966501	LL-1	LIFE LINE, 50 ft. Rescue Throw Bag	EA	21.99	J

## BOAT SAFETY KIT

This boat safety kit contains 4 items required by the Canadian Coast Guard for boats up to 8 meters (26 ft.) long. Recommended for all boats. Contents: 15 meter (50 ft.) Buoyant Heaving Line. Bailer (watertight container). Sound Signaling Device (pea-less whistle). Watertight Flashlight.



PART #	MFG #	DESCRIPTION	U/M		
966502	LL-2	LIFE LINE Boat Safety Kit	KIT	12.49	J



## BUNGEE DOCK LINE

AIRHEAD Bungee Dock Lines absorb shock to boats, cleats, docks, pylons and other hardware. The bungee cord is hidden inside the rope and acts as a built-in snubber. Two foam floats protect the boat from chafing. There's a sliding adjustment at both ends for quick docking. Recommended for docking boats and PWCs up to 4,000 pounds. Tensile strength is 2,150 pounds. Black/Blue/Red color scheme.

PART #	MFG #	DESCRIPTION	U/M		
966156	AHDL-4	AIRHEAD Bungee Dock Line, 4 ft.	EA	11.99	J
966157	AHDL-5	AIRHEAD Bungee Dock Line, 5 ft.	EA	12.99	J
966158	AHDL-6	AIRHEAD Bungee Dock Line, 6 ft.	EA	13.99	J

## KWIK-CONNECT

Conveniently attach and detach tube tow ropes to towables with AIRHEAD's Kwik-Connect. There's no need to thread 60 feet of rope through the tow strap each time you connect or disconnect a tow rope. The high impact Kwik-Connect has a 1 inch diameter hole to accept up to 6,000 lb. break strength tube ropes. Recommended for 1 to 4 rider towables that are not equipped with Kwik-Connects.

PART #	MFG #	DESCRIPTION	U/M		
966186	AHKC-1	AIRHEAD Kwik-Connect	EA	9.99	J



## AIRHEAD LINE WINDER

No more tangled lines with this classic styled floating line winder! It's easy to wind and neatly stow away anchor lines, mooring lines, ski ropes and tube ropes. Get a few for the garage too. Organize your extension cords, wires, clotheslines and Christmas lights once and for all. It's constructed of high impact polypropylene for extra long service. Color: Red. Ropes not included.

PART #	MFG #	DESCRIPTION	U/M		
966187	AHLW-1	AIRHEAD Line Winder	EA	7.99	J

MARINE

# AIRHEAD

**NEW  
PRODUCT**



## SUP STABILIZERS

Stabilizers are constructed of heavy duty PVC enclosed in 420-denier nylon covers and Training Wheels are made of heavy duty PVC only. Stabilizers will provide extended life in comparison to Training Wheels. This is due to their nylon cover acting as an extra protective layer that will withstand more wear and use over time than the Training Wheels whose PVC is exposed at all times.

- Convert any SUP to a stable platform for fishing, yoga or bringing a dog or child along
- Great for beginners, rough water & plus size paddlers
- Rugged nylon covers protect the PVC bladders inside
- Inflate/Deflate in seconds with patented Speed Safety Valves

PART #	MFG #	DESCRIPTION	U/M	
968137	AHSUP-A005	SUB Stabilizers	SET	69.99 J



## SUP TRAINING WHEELS

- Training Wheels are made of heavy duty PVC only and stabilizers are constructed of heavy duty PVC enclosed in 420-denier nylon covers.
- Convert any SUP to a stable platform for fishing, yoga or bringing a dog or child along
- Great for beginners, rough water & plus size paddlers
- Durable PVC construction
- Inflate/Deflate in seconds with patented Speed Safety Valves

PART #	MFG #	DESCRIPTION	U/M	
968138	AHSUP-A006	SUP Training Wheels	SET	49.99 J



## SUP CARRIER

- Convenient, comfortable & easy to use
- Integrated water bottle holder
- Integrated mesh bag with D-rings to stow & attach to your board
- Great for surfboards & kayaks too!

PART #	MFG #	DESCRIPTION	U/M	
968146	AHSUP-A016	SUP Carrier	EA	21.99 J

accessories

towables

body

controls

electrical

driveline

engine

fuel & intake

chemicals

tie downs

tools

towing & loading

MARINE



NEW  
PRODUCT

**AIRHEAD**

accessories

towables

body

controls

electrical

driveline

engine

fuel & intake

chemicals

tie downs

tools

towing & loading

MARINE



### DELUXE COAST GUARD KIT

- Exceeds Coast Guard requirements
- Universal Type III open sided 3 belt vest fits all adults
- Pealess safety whistle
- Emergency signaling mirror
- Mesh bag with 3 handy D-rings & suction cups, great for storing other gear too!

PART #	MFG #	DESCRIPTION	U/M	
968147	AHSUP-A020	Deluxe Coast Guard Kit	EA	34.99 J



### BASIC COAST GUARD KIT

- Meets Coast Guard requirements
- Type II PFD fits most adults
- Pealess safety whistle
- Mesh bag with 3 handy D-rings & suction cups, great for storing other gear too!

PART #	MFG #	DESCRIPTION	U/M	
968148	AHSUP-A021	Basic Coast Guard Kit	EA	19.99 J



### SUP BUNGEE CARGO NET

- Heavy-Duty 15 x 15 in. stretch cord net secures gear to your sup or kayak
- 2 attachment options!
- 4 Hi-Impact lashing points with 3M adhesive backing
- 4 suction cups to attach net to most fiberglass decks
- Tether other items to the lashing points too!

PART #	MFG #	DESCRIPTION	U/M	
968149	AHSUP-A024	SUP Bungee Cargo Net	EA	19.99 J



### SUP ANCHOR KIT

- Great for taking a break, fishing or yoga
- Bright red Grapnel Anchor, 1.5 lbs
- Padded nylon storage bag with webbing & D-ring to secure to SUP or Kayak
- Durable 15 ft. yellow anchor line with stainless spring hook

PART #	MFG #	DESCRIPTION	U/M	
968145	AHSUP-A015	SUP Anchor Kit	EA	29.99 J

# AIRHEAD

**NEW  
PRODUCT**

accessories

towables

body

controls

electrical

driveline

engine

fuel & intake

chemicals

tie downs

tools

towing & loading



## HEAVY DUTY LEASH

- Lightweight coiled leash stays out of your way while you're paddling
- Allows you full freedom of motion
- Extends to 11 feet
- 2 in-line swivels keep the leash from tangling
- 2" wide padded calf strap provides all-day comfort
- Recommended for surf and lake use, (not whitewater)

PART #	MFG #	DESCRIPTION	U/M		
968139	AHSUP-A007	Heavy Duty Leash	EA	29.99	J



## SCRUNCHY LEASH & TOW STRAP

- Lightweight accordion style webbing
- 2 inline swivels keep the leash from tangling
- Comfortable neoprene lined ankle cuff
- Stretches to 11 ft.

PART #	MFG #	DESCRIPTION	U/M		
968140	AHSUP-A008	Scrunchy Leash & Tow Strap	EA	19.99	J

MARINE



## PADDLE / ROD LEASH

- Stretches from 24 – 60 inches.
- Swivel hooks & comfortable collars for lots of attachment options
- Easily connect to paddle with adjustable velcro strap
- Great for Fishing Poles too!

PART #	MFG #	DESCRIPTION	U/M		
968141	AHSUP-A009	Paddle / Rod Leash	EA	14.99	J

NEW  
PRODUCT

**AIRHEAD**

accessories



**PAWS PAD**

- Simple to attach
- Charcoal Gray

- Provides a comfortable slip free spot for "Fido"
- Durable EVA Foam with self adhesive backing

PART #	MFG #	DESCRIPTION	U/M		
968143	AHSUP-A011	Paws Pad	EA	29.99	J

towables

body

controls

electrical

driveline

engine

fuel & intake

chemicals

tie downs

tools

towing & loading



**SUCTION CUP TIE DOWNS**

- Thousands of uses!
- Suction cup activated / deactivated with mechanical lever
- For smooth fiberglass surfaces
- Versatile Duraflex wide gate spring hook
- Heavy duty webbing
- 2 per package

PART #	MFG #	DESCRIPTION	U/M		
968142	AHSUP-A010	Suction Cup Tie Downs	EA	15.99	J



**LASHING TABS**

- For SUPs, Boats, Camping & More
- Thousands of Uses!
- Strong EZ to Use Adhesive Backing
- 4 Per Package

PART #	MFG #	DESCRIPTION	U/M		
968144	AHSUP-A012	Lashing Tabs	EA	5.99	J

MARINE

## AIRHEAD

### AQUA ZOOKA

Soak your friends with AQUA ZOOKA! This easy to operate, quick filling water bazooka is constructed of high-impact thermoplastics, and will last for seasons of fun. Simply dip AQUA ZOOKA into the water and pull back on the handle to siphon water up into the barrel. You're ready to fire, with a range of up to 60 feet! AQUA ZOOKAs are equipped with comfortable EVA handles so that you won't lose your grip, even with wet hands in the heat of battle! The EVA handles also ensure that AQUA ZOOKA will float on top of the water. Doubles as a bilge pump or household siphon!

## AQUA-ZOOKA™



PART #	MFG #	DESCRIPTION	U/M
966413	AZ-12	AQUA ZOOKA, 12" barrel	EA 8.49 J
966414	AZ-18	AQUA ZOOKA, 18" barrel	EA 11.99 J
966418	AZ-24	AQUA ZOOKA, 24" barrel	EA 14.99 J
966419	AZ-32	AQUA ZOOKA, 32" barrel	EA 16.99 J



### AQUA ZOOKA DISPLAY

Kids can't possibly miss this display! This could be the most successful display you've ever put in your store! It's easy to refill with four replaceable bins holding a total of 48 18 inch water guns. They retail at an impulse price point, so watch them fly out of the store! Sets up in under 5 minutes. Dimensions: 60" H x 13.5" W x 19" D.

PART #	MFG #	DESCRIPTION	U/M
966415	AZ-18 DISP	AQUA ZOOKA DISPLAY, 18", 48 ea.	EA 575.52 H



### AQUA ZOOKA 18" DISPLAY REFILL

This counter-top or shelf display holds 42 of our popular AQUA ZOOKA 18" water guns. Kids won't miss it! Guaranteed to increase sales in any retail store!

PART #	MFG #	DESCRIPTION	U/M
966417	AZ-18R	AQUA ZOOKA DISPLAY REFILL, 18", 42 ea.	EA 287.76 J

### AQUA ZOOKA DOUBLE SHOT™

You'll have double the fun soaking your friends with AQUA ZOOKA DOUBLE SHOT! This easy to operate, over/under double barrel quick-filling water bazooka is constructed of high-impact thermoplastics to take a lot of punishment. Simply dip it into the water and pull back on the handle to siphon water up into both barrels. You're ready to fire; the double stream has a range of up to 60 feet! Equipped with comfortable EVA handle so that you won't lose your grip, even with wet hands in the heat of battle! The EVA handle also ensure that AQUA ZOOKA will float. Size: 18 inches long



PART #	MFG #	DESCRIPTION	U/M
966666	AZ-18 DS	AQUA ZOOKA DOUBLE SHOT	EA 17.99 J

- accessories
- towables
- body
- controls
- electrical
- driveline
- engine
- fuel & intake
- chemicals
- tie downs
- tools
- towing & loading

AQUA-ZOOKA™

AIRHEAD®



**AQUA ZOOKA® BIG SHOT™**

Ready, Aim, Fire! AQUA ZOOKA BIG SHOT's oversized barrels deliver the friend drenching spray you're after! Designed for extreme water battles, just dip the tip in the water and pull back on the ergonomic pistol grip to fill. Now you're ready to fire! The new patent pending "HexDraw" system speeds up reloading and increases efficiency so you're sucking up water, not air. Shoots up to 60 feet! Durable high impact plastic construction.



PART #	MFG #	DESCRIPTION	U/M		
968156	AZ-P18	AQUA ZOOKA BIG SHOT, 18" long	EA	12.99	J
968158	AZ-P24	AQUA ZOOKA BIG SHOT, 24" long	EA	14.99	J

**NEW PRODUCT**

**AQUA ZOOKA® DOUBLE BIG SHOT™**

Ready, Aim, Fire! AQUA ZOOKA DOUBLE BIG SHOT's tandem oversized barrels deliver double the friend drenching power! Designed for the most extreme water battles, just dip the tip in the water and pull back on the ergonomic pistol grip to fill. Now you're ready to fire! The new patent pending "HexDraw" system speeds up reloading and increases efficiency so you're sucking up water, not air. Shoots up to 60 feet! Durable high impact plastic construction.



PART #	MFG #	DESCRIPTION	U/M		
968157	AZ-P18DS	AQUA ZOOKA DOUBLE BIG SHOT, 18" long	EA	20.99	J
968159	AZ-P24DS	AQUA ZOOKA DOUBLE BIG SHOT, 24" long	EA	22.99	J

**NEW PRODUCT**

- accessories
- towables
- body
- controls
- electrical
- driveline
- engine
- fuel & intake
- chemicals
- tie downs
- tools
- towing & loading

MARINE

accessories

towables

body

controls

electrical

driveline

engine

fuel & intake

chemicals

tie downs

tools

towing & loading



## ELECTROPOD ACCESSORY LIGHTING

ElectroPods add a constant glow to create the perfect mood for state rooms, galleys and bars. Six ultra bright LED's are arranged in a compact mountable pod. Pods come complete with screws and double sided adhesive tape for easy interior or exterior installation. Pods run off 12 volts and contain their own inline fuse for easy wiring into fuse box, accessory switch or ignition. Low energy draw from each battery. Perfect for lighting areas with small mounting surface. Equipped with double insulated wiring.

- LEDs arranged for maximum brightness
- Weather and wake resistant
- LED bulb life is approximately 100,000 hours
- Low current draw, 50-70 mA's per light

PART #		COLOR	
906151	16.99	Q	Blue LEDs
906153	16.99	Q	White LEDs
906154	16.99	Q	Red LEDs



## LINEAR LIGHT STRIPS

Six ultra-bright LEDs mounted on a thin linear strip were engineered specifically for your boat's cabin, walkway and deck. Weather- and wake-resistant and able to withstand the elements, Linear Strips are ideal for life on the open water.

Each Linear Strip is equipped with double insulated wiring and can be connected together in a series for maximum coverage.

- All cables and assembly instruction included
- Weather and wake resistant
- Low current draw, 50-70 mA's per light
- LED bulb life approximately 100,000 hours
- Powered by 12 volt battery
- Strips 7" in length

PART #		COLOR	
906155	22.50	Q	Blue LEDs
906156	22.50	Q	White LEDs



MARINE



## MARKER LIGHTS

Light-up the interior or exterior of your watercraft. The sleek design of Marker Lights is perfect for lighting stairways, access ways and decks. Thin, waterproof strips feature six ultra bright LED's, cables and complete mounting instructions included.

- All cables and assembly instruction included
- Weather and wake resistant
- Low current draw, 50-70 mA's per light
- LED bulb life approximately 100,000 hours
- Powered by 12 volt battery
- Strips 4.25" in length

PART #	COLOR
906158 16.99 Q	Blue LEDs
906159 16.99 Q	White LEDs
906160 16.99 Q	Red LEDs



## LASER LIGHT SAVER

Attach the Laser Light Saver LED Distress Strobe Light with Signal Laser to your life vest, life ring or other PFD and never have to worry about your visibility in the water again!

Liquid-activated LEDs automatically start flashing when you are in the water, and the LEDs will turn off automatically when dry. Attach Laser Light Saver to your life vest, life ring or other personal flotation device and Laser Light Saver stays afloat and shines its powerful super-bright white LEDs, giving you additional 360-degree visibility. The powerful signal laser can help you to be seen from up to 2 nautical miles!

Constructed of water resistant plastic. Super bright white LEDs are rated at over 100K hours. Batteries are replaceable.

PART #	COLOR
906163 89.95 V	Green Laser



- accessories
- towables
- body
- controls
- electrical
- driveline
- engine
- fuel & intake
- chemicals
- tie downs
- tools
- towing & loading

MARINE



- accessories
- towables
- body
- controls
- electrical
- driveline
- engine
- fuel & intake
- chemicals
- tie downs
- tools
- towing & loading

## KEY FLOATS

Our key floats are the perfect way to keep your keys close at hand. We've even included a quick snap for easy attachment wherever you need it.



PART #		COLOR	
983042	5.45	B	Red
983043	5.45	B	Blue
983044	5.45	B	Yellow

## KEYTAINER

Now an easy way to carry and keep your money or registration dry. The key chains also float!



PART #	SIZE
983045	4.95 B Large
983046	4.95 B Small

## DRAIN PLUG

Now you can replace or add another drain plug without paying high manufacturers prices with our new A2265 plug. Great Price Great Plug. Our floating drain plug is oil and fuel resistant just flip or twist to install.



PART #	COLOR	APPLICATION
983047	7.35 B Black	'95 & newer SeaDoo/Polaris/Honda
983048	7.35 B White	'95 & newer SeaDoo/Polaris Honda
983049	5.95 B Red & Black	pre 1995 SeaDoo & Polaris

## SPEC FLOATS FLOATING SUNGLASSES CORDS

The quick and easy way to float your expensive glasses. Our Spec Floats have universal ends to fit all types of frames Skinny to fat ones just slide them on.

PART #	COLOR
983050	6.95 G Silver
983051	6.95 G Green
983052	6.95 G Blue
983053	6.95 G Neon Red
983054	6.95 G Gold
983055	6.95 G Burgundy
983056	6.95 G Purple
983057	6.95 G Black
983058	6.95 G White
983059	6.95 G Dark Red
983060	6.95 G Teal
983061	6.95 G Yellow
983062	6.95 G Red
983063	6.95 G Forrest Green







accessories

towables

body

controls

electrical

driveline

engine

fuel & intake

chemicals

tie downs

tools

towing & loading

## PWC BAG ANCHOR

Our newly redesigned bag anchor is strong as ever but with bright new colors. Comes with rope, float, and hook. Just fill with rocks and sand for your anchoring needs. Fits easily into any storage compartment.



PART #		COLOR	
983064	20.25	B	Blue
983065	20.25	B	Red



## ANCHOR STAKE KIT

Needing an easy way to keep your personal watercraft tied to shore? Here it is, just screw the stake into the ground and you have 15' to tether your boat to shore. Easy to store and take with you.

PART #		COLOR	
983066	28.95	B	Blue
983067	28.95	B	Red

## DELUXE PWC SAND STAKE KIT

Need to anchor your PWC on a sandy beach? This is the way. Just screw it in and it is set. It will not pull out. Comes with a cushioned travel bag.

PART #		
983068	49.95	B



## HULL GUARD FENDER

The oval design of the fenders prevents them from rolling out of place. They have molded in eyelets and have an inflation valve to adjust their level of firmness.

PART #		SIZE	COLOR
983109	30.95	B 23"	White
983110	21.95	B 18"	Blue
983111	22.85	B 18"	White
983112	18.95	B 16"	Blue
983113	18.95	B 16"	White

MARINE

accessories

towables

body

controls

electrical

driveline

engine

fuel & intake

chemicals

tie downs

tools

towing & loading



## UNIVERSAL SHOP LANYARD

Lanyards designed for shop use only! These can easily be attached to your belt while working on all PWC and jet boats.

PART #	DESCRIPTION
983069	Black Shop Lanyard
983009	Black Shop Lanyard w/DESS End



PART #	COLOR	APPLICATION
983089	Black	Kawasaki, Polaris, Tigershark, Wetjet
983090	Dark Blue	Kawasaki, Polaris, Tigershark, Wetjet
983091	Pink	Kawasaki, Polaris, Tigershark, Wetjet
983092	Red	Kawasaki, Polaris, Tigershark, Wetjet
983093	Yellow	Kawasaki, Polaris, Tigershark, Wetjet
983094	Black	SeaDoo
983095	Dark Blue	SeaDoo
983096	Pink	SeaDoo
983097	Red	SeaDoo
983098	Yellow	SeaDoo
983099	Black	Yamaha
983100	Dark Blue	Yamaha
983101	Pink	Yamaha
983102	Red	Yamaha
983103	Yellow	Yamaha

## PERFORMANCE LANYARDS

Atlantis has created the "Performance" lanyard from the suggestions and feedback from Pro Racers, Freestylers, and Freeriders. This lanyard features the float tube at the rear point of the lanyard next to the vest clip. This location modification still provides the lanyard assembly with flotation yet keeps the area around the key almost weightless and free of any extra objects that may come in contact with water during aggressive riding which sometimes causes the key to pull out unwillingly.



## REPLACEMENT FLOATING LANYARDS

Atlantis has created this product as a direct replacement for any make and model's lanyard. This product is ideal for any and all OEM lanyards that have lost their rubberized coating exposing the inner string which removes the convenient coil effect of their original state. This problem is most common with OEM "DESS" and all normal lanyards. This product can easily be used by utilizing the convenient stainless clip to attach the desired lanyard key to and have a "like new" floating lanyard in seconds. The replacement lanyard has a stainless clip to secure any desired lanyard piece, an attached flotation tube, and plastic vest clip.



PART #	COLOR
983104	Black
983105	Dark Blue
983106	Pink
983107	Red
983108	Yellow



PART #	COLOR
983075	Black
983076	Dark Blue
983077	Red
983078	Yellow

## DESS COMPATIBLE LANYARDS

Atlantis is proud to offer the only after market lanyards that are compatible with Sea-Doo's DESS system. These lanyards fit all Sea-Doo watercraft, Jet Boats, and Snowmobiles from 1996 to current, except '96 XP & GTI. Program with factory programmer.

## STANDARD LANYARDS

Our new improved standard lanyard now floats! Now an easy way to keep an extra lanyard close at hand.



PART #	COLOR	APPLICATION
983070	Black	Kawasaki, Polaris, Tigershark, Wetjet
983071	Dark Blue	Kawasaki, Polaris, Tigershark, Wetjet
983072	Pink	Kawasaki, Polaris, Tigershark, Wetjet
983073	Red	Kawasaki, Polaris, Tigershark, Wetjet
983074	Yellow	Kawasaki, Polaris, Tigershark, Wetjet
983079	Black	SeaDoo
983080	Dark Blue	SeaDoo
983081	Pink	SeaDoo
983082	Red	SeaDoo
983083	Yellow	SeaDoo
983084	Black	Yamaha
983085	Dark Blue	Yamaha
983086	Neon Yellow	Yamaha
983087	Pink	Yamaha
983088	Red	Yamaha

MARINE



**TOWABLES**



- accessories
- towables
- body
- controls
- electrical
- driveline
- engine
- fuel & intake
- chemicals
- tie downs
- tools
- towing & loading

### RADICAL WAKEBOARD COMBOS

RADICAL's abstract geometric graphics really catch the eye. It delivers smooth transitions through turns and a consistent pop off the wake. The floaty nature of this 143cm free-ride wakeboard is designed to help riders of all levels excel at the sport. The rounded end profile and beveled perimeter provide a forgiving and consistent release off the wake. Designed for riders over 150 lbs., performance is unprecedented in a board with this price point. Two removable fiberglass reinforced nylon fins provide excellent tracking.

- Eye catching abstract geometric graphics
- Delivers smooth transitions through turns and a consistent pop off the wake
- Floaty nature designed to help riders of all levels excel at the sport
- Rounded end profile and beveled perimeter provide a forgiving and consistent release off the wake
- Two removable fiberglass reinforced nylon fins provide excellent tracking
- Designed for riders over 150 lbs.
- 143cm



#### CLUTCH BINDING

- AIRHEAD's most supportive binding, designed for demanding riders
- Upper and lower double cinch lace-up system provides a great fit without pressure points
- 5 independent lace eyelets and adjustable toe strap
- The orthotic footbed offers a perfect combination of support and cushion
- Mounting area is reinforced with aluminum plates for durability
- Fits men's size 8 – 12 (EU 37- 46)

PART #	MFG #	U/M	DESCRIPTION	
966317	AHW-3024	EA	AIRHEAD RADICAL WAKEBOARD w/ Clutch binding	399.99 J

#### GRIND BINDING

- Versatile option for a wide range of foot sizes and riding abilities
- One cinch adjustability of the front-entry lace-up design
- Offers the fit and support to allow riders to progress quickly
- Great binding for the whole family
- Fits men's size 8 – 12 (EU 41- 46)

PART #	MFG #	U/M	DESCRIPTION	
966318	AHW-3026	EA	AIRHEAD RADICAL WAKEBOARD w/ Grind binding	329.99 J



#### PRIMO BINDING

- Performance Series bindings are stiffer and more form fitting than the standard series
- Superior support for demanding wakeboarders
- Upper and lower cinch lace-up system with 5 pair of independent lace eyelets
- All riding styles are accommodated by the versatile mounting plate
- Size: M (US Men's 8 – 11) ( EU sizes 41 – 45).

PART #	MFG #	U/M	DESCRIPTION	
966319	AHW-3029	EA	AIRHEAD RADICAL WAKEBOARD w/ Primo binding	359.99 J

**FLUID WAKEBOARD COMBOS**

FLUID is designed for intermediate to expert riders weighing 90 -170 lbs.. The 6 fin dual thruster setup provides ultimate hold and tracking. Riders stay on edge, get more speed into the wake and stomp landings without slipping out. The removable center fins provide tracking. The side fins are curved and angle outwards at 11 degrees to provide extra edge hold and a loose feel in neutral. The continuous rocker is fast and forgiving with smooth pop.

- Designed for intermediate to expert riders
- 6 fin dual thruster setup provides the ultimate in hold and tracking
- Stay on edge and get more speed into the wake
- Stomp landings without slipping out
- The removable center fins provide tracking
- Side fins are curved and angle outwards at 11 degrees to provide extra edge hold and a loose feel in neutral
- Continuous rocker is fast and forgiving with smooth pop
- Designed for riders weighing up to 170 lbs.
- 134cm

**BOSS BINDING**

These bindings will make you the wakeboard BOSS! They're noticeably stiffer and more form fitting than our Standard Series bindings. BOSS offers superior support for demanding wakeboarders. A comfortable and tight fit is provided by the upper and lower cinch lace-up system and 5 pair of independent lace eyelets. The textured footbed offers the perfect combination of support and cushion. All riding styles are accommodated by the versatile mounting plate. Size: L (US Men's 11 – 15) (EU sizes 45 – 50).



PART #	MFG #	U/M	DESCRIPTION	
966331	AHW-40210	EA	AIRHEAD FLUID WAKEBOARD w/ Boss binding	349.99 J



**CLUTCH BINDING**

- AIRHEAD's most supportive binding, designed for demanding riders
- Upper and lower double cinch lace-up system provides a great fit without pressure points
- 5 independent lace eyelets and adjustable toe strap
- The orthotic footbed offers a perfect combination of support and cushion
- Mounting area is reinforced with aluminum plates for durability
- Fits men's size 8 – 12 (EU 37- 46)

PART #	MFG #	U/M	DESCRIPTION	
966332	AHW-4024	EA	AIRHEAD FLUID WAKEBOARD w/ Clutch binding	369.99 J

**GRIND BINDING**

- Versatile option for a wide range of foot sizes and riding abilities
- One cinch adjustability of the front-entry lace-up design
- Offers the fit and support to allow riders to progress quickly
- Great binding for the whole family
- Fits men's size 8 – 12 (EU 41- 46)

PART #	MFG #	U/M	DESCRIPTION	
966333	AHW-4026	EA	AIRHEAD FLUID WAKEBOARD w/ Grind binding	319.99 J



**PRIMO BINDING**

- Performance Series bindings are stiffer and more form fitting than the standard series
- Superior support for demanding wakeboarders
- Upper and lower cinch lace-up system with 5 pair of independent lace eyelets
- All riding styles are accommodated by the versatile mounting plate
- Size: M (US Men's 8 – 11) (EU sizes 41 – 45).

PART #	MFG #	U/M	DESCRIPTION	
966334	AHW-4029	EA	AIRHEAD FLUID WAKEBOARD w/ Primo binding	349.99 J





**AIRHEAD®  
WAKE & SKI**

- accessories
- towables
- body
- controls
- electrical
- driveline
- engine
- fuel & intake
- chemicals
- tie downs
- tools
- towing & loading

## SPLASH™ WAKEBOARD

SPLASH is 124cm long, perfect for youth riders up to 130 lbs. It's a lightweight twin tip free-ride wakeboard designed to help youth riders of all levels improve their skills. The continuous rocker is fast and forgiving with smooth pop. Performance and durability are packed into this price point board. The RIM core has a PBT top with sublimated graphics. Two removable fiberglass reinforced nylon fins provide excellent tracking and carving.



PART #	MFG #	U/M	DESCRIPTION		
966297	AHW-1020	EA	AIRHEAD SPLASH Wakeboard	169.99	J



## BOOYAH WAKEBOARD

You'll scream BOOYAH! after one ride on this AIRHEAD wakeboard! BOOYAH is designed for riders looking for smooth transition through turns and a consistent pop off the wake. The rounded end profile and beveled perimeter provide a forgiving and consistent release. The floaty nature of this 135cm freeride wakeboard is designed to help riders of all levels improve their wakeboarding prowess. Designed for riders up to 170 lbs.. Two removable fiberglass reinforced nylon fins provide excellent tracking.

PART #	MFG #	U/M	DESCRIPTION		
966303	AHW-2010	EA	AIRHEAD BOOYAH Wakeboard	179.99	L

## RADICAL WAKEBOARD

RADICAL's abstract geometric graphics really catch the eye. It delivers smooth transitions through turns and a consistent pop off the wake. The floaty nature of this 143cm free-ride wakeboard is designed to help riders of all levels excel at the sport. The rounded end profile and beveled perimeter provide a forgiving and consistent release off the wake. Designed for riders over 150 lbs., performance is unprecedented in a board with this price point. Two removable fiberglass reinforced nylon fins provide excellent tracking.

PART #	MFG #	U/M	DESCRIPTION		
966315	AHW-3020	EA	AIRHEAD RADICAL Wakeboard	219.99	J



## GRAFITTI CITY™ WAKEBOARD

GRAFITTI CITY delivers smooth transitions through turns and a consistent pop off the wake. The floaty nature of this 143cm free-ride wakeboard is designed to help riders of all levels excel at the sport. The rounded end profile and beveled perimeter provide a forgiving and consistent release off the wake. Designed for riders over 150 lbs., performance is unprecedented in a board with this price point. Two removable fiberglass reinforced nylon fins provide excellent tracking.

PART #	MFG #	U/M	DESCRIPTION		
966311	AHW-3010	EA	AIRHEAD GRAFITTI CITY Wakeboard	189.99	L



**AIRHEAD®  
WAKE & SKI**



- accessories
- towables**
- body
- controls
- electrical
- driveline
- engine
- fuel & intake
- chemicals
- tie downs
- tools
- towing & loading

**FLUID WAKEBOARD**

FLUID is designed for intermediate to expert riders weighing 90 -170 lbs. The 6 fin dual thruster setup provides the ultimate in hold and tracking. Stay on edge, get more speed into the wake and stomp landings without slipping out. The removable center fins provide tracking. The side fins are curved and angle outwards at 11 degrees to provide extra edge hold and a loose feel in neutral. The continuous rocker is fast and forgiving with smooth pop.



PART #	MFG #	U/M	DESCRIPTION		
966330	AHW-4020	EA	AIRHEAD FLUID Wakeboard	219.99	J



**APOCALYPSE™ WAKEBOARD**

APOCALYPSE is designed for intermediate to expert riders weighing 90 -170 lbs. The 6 fin dual thruster setup provides the ultimate in hold and tracking. Stay on edge, get more speed into the wake and stomp landings without slipping out. The removable center fins provide tracking. The side fins are curved and angle outwards at 11 degrees to provide extra edge hold and a loose feel in neutral. The continuous rocker is fast and forgiving with smooth pop.

PART #	MFG #	U/M	DESCRIPTION		
966325	AHW-4010	EA	AIRHEAD APOCALYPSE Wakeboard	189.99	L

**SHOCKWAVE CARBON WAKEBOARD**

Experienced riders will enjoy the lightning quick response of our stiff SHOCKWAVE carbon fiber reinforced wakeboard. This board turns quicker and holds a harder edge than our non-carbon reinforced boards. 24/7 is designed for intermediate to expert riders weighing 150 lbs. and up. The 6 fin dual thruster setup provides ultimate hold and tracking. Riders stay on edge, get more speed into the wake and stomp landings without slipping out. The removable center fins provide tracking. The side fins are curved and angle outwards at 11 degrees to provide extra edge hold and a loose feel in neutral. The continuous rocker is fast and forgiving with smooth pop.



PART #	MFG #	U/M	DESCRIPTION		
966361	AHW-8010	EA	AIRHEAD SHOCKWAVE CARBON Wakeboard	239.99	L



**INSIDE OUT WAKEBOARD**

INSIDE OUT will turn your wakeboard experience inside out! It's designed for intermediate to expert riders weighing 150 lbs. and up. The 6 fin dual thruster setup provides ultimate hold and tracking. Riders stay on edge, get more speed into the wake and stomp landings without slipping out. The removable center fins provide tracking. The side fins are curved and angle outwards at 11 degrees to provide extra edge hold and a loose feel in neutral. The continuous rocker is fast and forgiving with smooth pop.

PART #	MFG #	U/M	DESCRIPTION		
966342	AHW-5020	EA	AIRHEAD INSIDE OUT Wakeboard	199.99	L

MARINE



**AIRHEAD®  
WAKE & SKI**

- accessories
- towables
- body
- controls
- electrical
- driveline
- engine
- fuel & intake
- chemicals
- tie downs
- tools
- towing & loading



## SHRED TIME WAKEBOARD

SHRED TIME is a lightweight twin tip freeride wakeboard designed to help youth riders of all levels excel at the sport. The continuous rocker is fast and forgiving with smooth pop. It's 124cm long, perfect for youth riders up to 130 lbs. Two removable fiberglass reinforced nylon fins provide excellent tracking and carving.

PART #	MFG #	U/M	DESCRIPTION		
966699	AHW-1030	EA	AIRHEAD SHRED TIME Wakeboard	199.99	J

## SPIKE WAKEBOARD

SPIKE is designed for riders looking for smooth transition through turns and a consistent pop off the wake. The rounded end profile and beveled perimeter provide a forgiving and consistent release off the wake. The floaty nature of this 135cm freeride wakeboard is designed to help riders of all levels excel at the sport. Designed for male and female riders up to 170 lbs., performance is unprecedented in a board with this price point. Two removable fiberglass reinforced nylon fins provide excellent tracking.



PART #	MFG #	U/M	DESCRIPTION		
966700	AHW-2020	EA	AIRHEAD SPIKE Wakeboard	209.99	J

## RIPSLASH WAKEBOARD

Designed for intermediate to expert riders weighing 150 lbs. and up. The 141cm 6 fin dual thruster setup provides ultimate hold and tracking. Riders stay on edge, get more speed into the wake and stomp landings without slipping out. The removable center fins provide tracking. The side fins are curved and angle outwards at 11 degrees to provide extra edge hold and a loose feel in neutral. The continuous rocker is fast and forgiving with smooth pop.



PART #	MFG #	U/M	DESCRIPTION		
966701	AHW-5050	EA	AIRHEAD RIPSLASH Wakeboard	229.99	J



**AIRHEAD®  
WAKE & SKI**



**WAKE SHAKER KNEEBOARD**

WAKE SHAKER's newly designed channeled bottom makes kneeboarding easier and more fun to ride! You'll love the easy rail to rail transitions, consistent arc through turns and effortless spins! Wake Shaker is great for all riding levels and has massive rocker and beveled edges for sharp turns without getting hung up during surface tricks. The deep knee wells provide ultimate comfort and control. The unique bottom features reduce water tension for a light, responsive feel. AIRHEAD's integrated EZ UP hook provides effortless starts every time and easy access to the rope handle.

PART #	MFG #	U/M	DESCRIPTION		
966683	AHKB-3	EA	AIRHEAD WAKE SHAKER Kneeboard	159.99	J



**BANZAI  
WAKESURFER**

BANZAI is the Cadillac of wakesurf boards. Its classic shape is easy to get up on and forgiving, perfect for beginners, intermediates, smaller wakes and bigger people. This compression molded fiberglass board with dual hook grooves grab the wake. The EVA pad with molded kicktail provides plenty of grip, control and balance. 3 profiled fins are mounted to recessed fin boxes. The pin shaped 2.5" rocker makes the board fast. Length: 63", center width 20.5". One size fits all.

PART #	MFG #	U/M	DESCRIPTION		
966670	AHWS-F01	EA	AIRHEAD BANZAI Wakesurfer	299.99	J

**PFISH SKIM STYLE WAKEBOARD**

PFISH is a really fun wakesurf board for any rider, beginner to advanced. The full shape and fish tail setup is forgiving and gives beginners an easy platform to learn the glide. Advanced riders will find it a nice stable board that shreds and cops air with ease. The extra thick grooved EVA deck has a ig kicker and provides excellent foothold. Our test riders have liked it better than boards that sell at twice the price. PFISH is 49" x 21" x 7/8", has 2 fins and is for riders up to 175 lbs. You'll be doing air reverses and shove-its in no time!

PART #	MFG #	U/M	DESCRIPTION		
968155	AHWS-F02	EA	AIRHEAD PFISH Wakeboard	269.99	J



- accessories
- towables
- body
- controls
- electrical
- driveline
- engine
- fuel & intake
- chemicals
- tie downs
- tools
- towing & loading

MARINE



**AIRHEAD®  
WAKE & SKI**

- accessories
- towables
- body
- controls
- electrical
- driveline
- engine
- fuel & intake
- chemicals
- tie downs
- tools
- towing & loading



## VENOM™ BINDING

VENOM is an open toe wakeboard boot to fit a wide range of sizes. It has left and right specific plates for a better fit and opens wide for easy entry. The lightweight chassis fits most feet. The flexible plastisol overlay and easy adjust lace system provide the fit and support you demand. You'll never lose your mounting hardware again with VENOM's captive thumbscrew system.

PART #	MFG #	U/M	DESCRIPTION		
968091	AHB-21	PR	AIRHEAD Venom Wakeboard Binding - Youth US size 4-8 (EU 36-41)	149.99	J
968092	AHB-22	PR	AIRHEAD Venom Wakeboard Binding - Men's US size 9-12 (EU 42-45)	159.99	J

## GOBLIN WAKEBOARD BINDING

We are proud to introduce a higher level of quality, comfort and performance with our new AIRHEAD GOBLIN wakeboard bindings! They offer superior support, comfort and responsiveness for the most demanding wakeboarders. A comfortable and tight fit is provided by the speed lace system and Velcro Power Strap. The textured foot bed offers the perfect combination of support and cushion. All riding styles are easily accommodated by the versatile mounting plate.

PART #	MFG #	U/M	DESCRIPTION		
966677	AHB-12M	PR	AIRHEAD Goblin Wakeboard Binding Medium - Men's US size 8-10 (EU 40-42)	199.99	J
966676	AHB-12L	PR	AIRHEAD Goblin Wakeboard Binding Large - Men's US size 11-13 (EU 43-45)	199.99	J



## CLUTCH™ BINDING

CLUTCH is AIRHEAD's most supportive binding, designed for demanding riders. A great fit without pressure points is guaranteed by the upper and lower double cinch lace-up system, 5 independent lace eyelets and adjustable toe strap. The orthotic footbed offers a perfect combination of support and cushion. The mounting area is reinforced with aluminum plates for durability. CLUTCH fits men's size 8 - 12 (EU 41- 46).

PART #	MFG #	U/M	DESCRIPTION		
966146	AHB-4	PR	AIRHEAD CLUTCH Binding	149.99	J

## GRIND™ ADULT BINDING

GRIND is a versatile option for a wide range of foot sizes and riding abilities. You'll love the one cinch adjustability of the front-entry lace-up design. A simple pull on the laces and you're ready to go. GRIND is very comfortable and user friendly, offering the fit and support to allow riders to progress quickly. It's a great binding for the whole family, fitting men's size 8 - 12 (EU 41- 46).

PART #	MFG #	U/M	DESCRIPTION		
966148	AHB-6	PR	AIRHEAD GRIND Adult Binding	109.99	J



## ASSAULT™ ADULT BINDING

AIRHEAD ASSAULT is an extra large binding designed with quality, durability and performance in mind. This supportive binding has an adjustable tow strap, heavy duty lace eyelets and a POWER STRAP for extra heel hold-down. The upper and lower double cinch lace-up system ensures a great fit. ASSAULT's footbed offers the perfect blend of cushion and support. The wakeboard mounting holes are reinforced with aluminum plates for durability. ASSAULT fits men's size 10 - 15.5 (EU 43 - 49).

PART #	MFG #	U/M	DESCRIPTION		
966149	AHB-7	PR	AIRHEAD ASSAULT XXL Binding	159.99	J

AIRHEAD®  
WAKE & SKI



- accessories
- towables**
- body
- controls
- electrical
- driveline
- engine
- fuel & intake
- chemicals
- tie downs
- tools
- towing & loading



**JUICE YOUTH PERFORMANCE BINDING**

AIRHEAD JUICE is the youth size of AIRHEAD's new Performance Series bindings. The performance series is noticeably stiffer and more form fitting than our Standard Series. JUICE offers superior support for demanding young wakeboarders. A comfortable and tight fit is provided by the upper and lower cinch lace-up system and 5 pair of independent lace eyelets. The textured footbed offers the perfect combination of support and cushion. All riding styles are accommodated by the versatile mounting plate. Size: S (US Men's 6 – 9) (EU sizes 39 – 43).

PART #	MFG #	U/M	DESCRIPTION		
966624	AHB-8	PR	AIRHEAD JUICE WB Binding	139.99	J

**PRIMO YOUTH PERFORMANCE BINDING**

PRIMO is the perfect name for this performance binding. They're noticeably stiffer and more form fitting than our Standard Series bindings. PRIMO offers superior support for demanding wakeboarders. A comfortable and tight fit is provided by the upper and lower cinch lace-up system and 5 pair of independent lace eyelets. The textured footbed offers the perfect combination of support and cushion. All riding styles are accommodated by the versatile mounting plate. Size: M (US Men's 8 – 11) (EU sizes 41 – 45).

PART #	MFG #	U/M	DESCRIPTION		
966151	AHB-9	PR	AIRHEAD PRIMO WB Binding	139.99	J



**BOSS YOUTH PERFORMANCE BINDING**

These bindings will make you the wakeboard BOSS! They're noticeably stiffer and more form fitting than our Standard Series bindings. BOSS offers superior support for demanding wakeboarders. A comfortable and tight fit is provided by the upper and lower cinch lace-up system and 5 pair of independent lace eyelets. The textured footbed offers the perfect combination of support and cushion. All riding styles are accommodated by the versatile mounting plate. Size: L (US Men's 11 – 15) (EU sizes 45 – 50).

PART #	MFG #	U/M	DESCRIPTION		
966143	AHB-10	PR	AIRHEAD BOSS WB Binding	139.99	J



**GRAB™ YOUTH BINDING**

GRAB is our top of the line high wrap youth wakeboard binding. Beginners through experts will enjoy the one cinch adjustability that this front entry lace-up binding provides. GRAB has the comfort and fit that allows youth riders to progress quickly. The POWER STRAP provides additional lower leg support for more power in turns. Fits all wakeboards. Fits kid's size 13 to men's size 8 (EU 31-41).

PART #	MFG #	U/M	DESCRIPTION		
966147	AHB-5	PR	AIRHEAD GRAB Youth Binding	99.99	J



**BOOT GOO  
BINDING LUBE**

It's easy to slide into tight waterski and wakeboard bindings with AIRHEAD BOOT GOO. It saves time and reduces wear and tear to bindings. BOOT GOO dissipates as soon as you hit the water for maximum performance. Environmentally safe non-hazardous formula. 16 oz. bottle with squirt top.

PART #	MFG #	U/M	DESCRIPTION		
966422	BG-1	EA	BOOT GOO Binding Lube, 16 oz.	7.99	L

MARINE



**AIRHEAD®  
WAKE & SKI**

- accessories
- towables
- body
- controls
- electrical
- driveline
- engine
- fuel & intake
- chemicals
- tie downs
- tools
- towing & loading

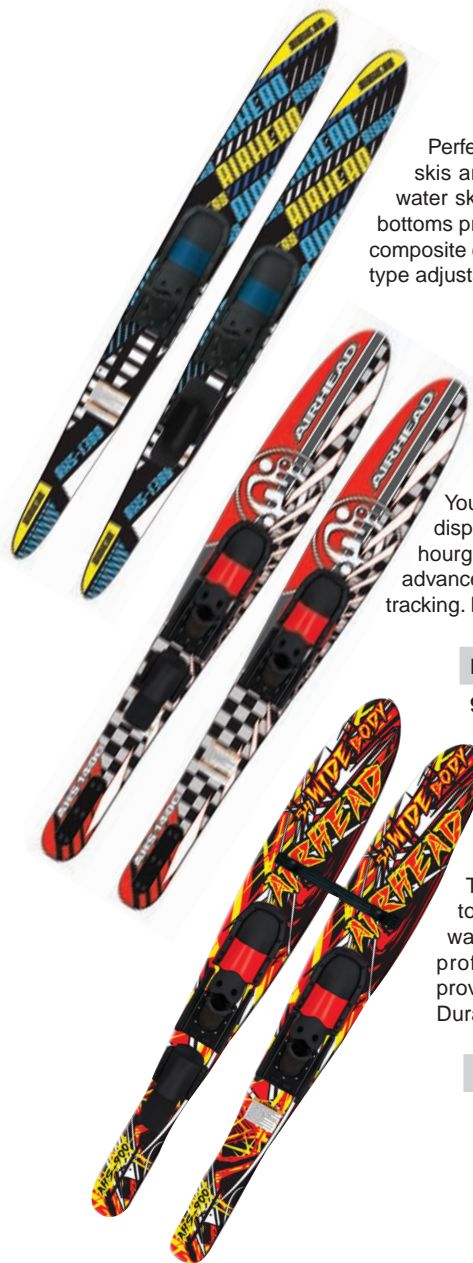

## S-1300 COMBO SKIS

Perfect for skiers who need a stable ride and want to advance their skills, AIRHEAD's combo water skis are a great value for the recreational water skiing family. These 67 inch rim molded combo water skis are designed to accommodate many different skill levels. Wide tails and tunnel shaped bottoms provide the ultimate balance of performance, control, stability and smooth tracking turns. The composite construction and fiberglass reinforced nylon fins ensure years of service. Dual density slide-type adjustable bindings fit US sizes 5 to 12

PART #	MFG #	U/M	DESCRIPTION		
966689	AHS-1300	PR	AIRHEAD S-1300 Combo Skis	199.99	J

## S-1400 WIDE BODY COMBO SKIS

You will love the stability and support of these 65.5" long wide-body skis. The extra wide tip displaces more water for easy start-ups and provides superior stability on top of the water. The hourglass shape provides quick low effort turning initiation even at slower boat speeds. More advanced skiers will enjoy the wide tips for jumping wakes. Fiberglass reinforced fins for precise tracking. Dual density slide-type adjustable bindings fit US sizes 5-12.

PART #	MFG #	U/M	DESCRIPTION		
966690	AHS-1400	PR	AIRHEAD S-1400 Wide Body Combo Skis, 65"	229.99	J

## WIDEBODY SKIS

These 54 in. wide body combo water skis are perfect for teaching teens and adults to deep water start, stand up, turn and drop a ski to slalom. No plowing through the water on these wide boys, they pop out of the water effortlessly. Once you get more proficient, the wide tips are excellent for jumping wakes. A removable cross bar is provided for first timers. The dual density bindings are adjustable from US sizes 5 to 12. Durable composite / foam core construction. Fiberglass reinforced nylon fins for tracking.

PART #	MFG #	U/M	DESCRIPTION		
966218	AHS-900	PR	AIRHEAD Widebody Ski, 135cm	229.99	L

**NEW  
PRODUCT**



## MONSTA SPLASH TRAINER WATER SKIS

These 48 inch wood trainers make learning to ski fun for beginners under 100 lbs. The double handle rope assembly, removable crossbar and ties at the tail make it easy to start and control. The adjustable bindings fit child size 12 to adult size 5. Fiberglass reinforced nylon rudders increase stability and tracking.

PART #	MFG #	U/M	DESCRIPTION		
968125	AHST-110	PR	AIRHEAD MONSTA SPLASH Trainer Skis	109.99	J



## BREAKTHRU WIDEBODY TRAINERS

We call these skis BREAKTHRU, because you'll learn how to deep water start and the basics of water skiing quickly and easily. They feature an oversized profile, parabolic side cut, tapered tail and comfortable adjustable bindings. The stabilizer bar keeps these 47" long skis steady while the student is learning to ski. Fiberglass reinforced nylon rudders increase stability and tracking. Designed for skiers up to 100 lbs. The adjustable bindings fit child size 12 to adult size 5.

PART #	MFG #	U/M	DESCRIPTION		
968126	AHST-120	PR	AIRHEAD BREAKTHRU Widebody Trainers	129.99	J

**AIRHEAD®  
TOWABLES**

**AIRHEAD**

**BIG EZ SKI  
INFLATABLE SINGLE RIDER  
TOWABLE WATER SKI HYBRID**



1 Rider

120 lbs. weight capacity

54" L x 34" W x 13" inflated

**EZ SKI TRAINER PUTS THE FUN BACK INTO TEACHING YOUNG SKIERS!**

EZ Ski is a revolutionary inflatable water ski hybrid with integrated wooden water ski trainers and ski bindings. EZ SKI is engineered for stability while towing (10 mph maximum), so your child will feel very secure. EZ SKI is the ultimate confidence builder, taking the tears, fear and frustration out of teaching new young skiers and replacing it with safety and fun! Your

child will enjoy immediate success. Children board the EZ SKI right from the swim step or stern of your boat, no swimming required. Children sit comfortably on the inflated seat for start-ups until they're ready to stand up and ski at their own pace. While your children have the time of their lives on EZ SKI, they'll actually be learning to be comfortable with the speed and sensation of water skiing and watersports in general. This awesome trainer teaches basic skiing fundamentals including proper stance, handle position, balance and weight transfer for turning.

PART #	MFG #	U/M	DESCRIPTION	
966680	AHEZ-200	EA	AIRHEAD BIG EZ SKI	249.99 J

**EZ SKI INFLATABLE SINGLE RIDER  
TOWABLE WATER SKI HYBRID**

**EZ SKI TRAINER PUTS THE FUN BACK INTO TEACHING YOUNG SKIERS!**

Heading for the lake but dreading the task of teaching another young skier? AIRHEAD EZ SKI to the rescue! EZ Ski is a revolutionary inflatable water ski hybrid with integrated wooden water ski trainers and ski bindings. EZ SKI is engineered for stability while towing (10 mph maximum), so your child will feel very secure. EZ SKI is the ultimate confidence builder, taking the tears, fear and frustration out of teaching new young skiers and replacing it with safety and fun! Your child will enjoy immediate success on the EZ SKI. No more fighting with diving water skis, ski skimmers, bindings, boat wakes or ropes! Children board the EZ SKI right from the swim step or stern of your boat, no swimming required. Children sit comfortably on the inflated seat for start-ups until they're ready to stand up and ski at their own pace. While your children have the time of their lives on EZ SKI, they'll actually be learning to be comfortable with the speed and sensation of water skiing and watersports in general. This awesome trainer teaches basic skiing fundamentals including proper stance, handle position, balance and weight transfer for turning.



1 Rider

70 lbs. weight capacity

46" L x 34" W x 13" H inflated

PART #	MFG #	U/M	DESCRIPTION	
966679	AHEZ-100	EA	AIRHEAD EZ SKI	199.99 J



**EZ WAKE TRAINER**

AIRHEAD EZ Wake Trainer is a revolutionary inflatable / bodyboard hybrid. It's engineered for stability while towing (10 mph maximum), so your child will feel very secure. It's also the ultimate confidence builder, taking the tears, fear and frustration out of teaching new young boarders and replacing it with safety and fun! Your child will enjoy immediate success. No fighting with diving wakeboards, boat wakes or ropes! Children board the stable EZ Wake Trainer right from the swim step or stern of your boat, no swimming required. While your children have the time of their lives, they'll actually be learning to be comfortable with the speed and sensation of watersports. This awesome trainer teaches basic wakeboarding, kneeboarding, wakesurfing and wakeskating fundamentals including proper stance, handle position, balance and weight transfer for turning. They'll be doing tricks in no time! The EZ Wake Trainer body board is easily removable for more advanced body boarding behind the boat, or take it to the beach and ride the waves!



**SKI TRAINER AND  
BODYBOARD IN 1!**

PART #	MFG #	U/M	DESCRIPTION	
966681	AHEZ-300	EA	AIRHEAD EZ WAKE Trainer	199.99 J

- accessories
- towables
- body
- controls
- electrical
- driveline
- engine
- fuel & intake
- chemicals
- tie downs
- tools
- towing & loading

**MARINE**



- accessories
- towables
- body
- controls
- electrical
- driveline
- engine
- fuel & intake
- chemicals
- tie downs
- tools
- towing & loading

### SHOCKWAVE 2

AIRHEAD SHOCKWAVE is a wave of excitement for 1 or 2 thrill-seekers! Defy centrifugal force with the bonus topside stabilizer fins. They help riders stay on the raft and provide a safer riding experience, keeping riders separated. The deluxe nylon-wrapped handles with neoprene knuckle guards provide a sure and comfortable grip. SHOCKWAVE has a tough heavy gauge virgin vinyl bladder, fully covered with a durable double-stitched nylon cover. It is equipped with a heavy-duty Kwik-Connect for easy and secure hook-ups. The patented Speed Safety Valves provide ultimate inflation and deflation convenience.



PART #	MFG #	U/M	DESCRIPTION		
966691	AHSH-2	EA	AIRHEAD SHOCKWAVE 2	279.99	J



### SHOCKWAVE 3

AIRHEAD SHOCKWAVE 3 is a wave of excitement for 1, 2 or 3 thrill-seekers! Defy centrifugal force with the bonus topside stabilizer fins. They help riders stay on the tube and provide a safer riding experience, keeping riders separated. The deluxe nylon-wrapped handles with neoprene knuckle guards provide a sure and comfortable grip. SHOCKWAVE has a tough heavy gauge virgin vinyl bladder, fully covered with a durable double-stitched nylon cover. It is equipped with a heavy-duty Kwik-Connect for easy and secure hook-ups. The patented Speed Safety Valves provide ultimate inflation and deflation convenience.



PART #	MFG #	U/M	DESCRIPTION		
966692	AHSH-3	EA	AIRHEAD SHOCKWAVE 3	379.99	J

**AIRHEAD®  
TOWABLES**



**RIP II®**

Carve turns with a tube? You can with RIP! Simply lean in the direction you want to turn and pull on the opposite handle. The plastic fins sewn onto the side of the cover do the carving. RIP is so much fun that you'll want to ride it all day long! You just might be able to, since it's so easy to re-board with the open back design, a feature that little ones and tired adults really appreciate. RIP is fully covered with rugged 840-denier double-stitched nylon cover, making it torsionally rigid to respond to rider's commands. RIP is 50 in. x 48 in. (deflated) and equipped with a Kwik-Connect, Boston valve and 4 deluxe nylon-covered handles with neoprene knuckle guards. Designed for 1 rider. Patented.

PART #	MFG #	U/M	DESCRIPTION
966210	AHRI-22	EA	AIRHEAD RIP II 169.99 J



**SLASH II®**

Two people can carve turns with SLASH III! Both riders simply lean in the direction they want to turn and pull on the opposite handle. The plastic fins sewn onto the side of the cover do the carving. SLASH II is so much fun that you'll want to ride it all day long! You just might be able to, since it's so easy to re-board with the open back design, a feature that little ones and tired adults really appreciate. SLASH II has a 30-gauge PVC bladder and is fully covered with double stitched 840-denier nylon, making it torsionally rigid to respond to rider's commands. It's equipped with a Kwik-Connect, Boston valve, and 4 nylon-wrapped handles with neoprene knuckle guards. Size 58 in. x 48 in. (deflated). Designed for 1 or 2 riders. Patented.

PART #	MFG #	U/M	DESCRIPTION
966222	AHSL-32	EA	AIRHEAD SLASH II 189.99 J



- accessories
- towables**
- body
- controls
- electrical
- driveline
- engine
- fuel & intake
- chemicals
- tie downs
- tools
- towing & loading

MARINE

# AIRHEAD

# AIRHEAD® TOWABLES

- accessories
- towables
- body
- controls
- electrical
- driveline
- engine
- fuel & intake
- chemicals
- tie downs
- tools
- towing & loading

## DISC-GO

DISC-GO is a real crowd pleaser with a fast learning curve. First time riders will be carving turns, riding backwards and doing 360s and even 720s in no time! This is the board that pleases like no other! DISC-GO is a huge polyurethane foam injected roto-molded disc with a rounded bottom. The soft EVA traction pad provides a great foothold. No matter how many "water toys" you have, this will be the kids favorite! When you're not towing it, the kids will spend hours playing on it and having balancing contests. 47" x 2"



PART #	MFG #	U/M	DESCRIPTION		
968093	AHDG-01	EA	AIRHEAD DISC-GO	229.99	J

## STORM II™ INFLATABLE DOUBLE RIDER TOWABLE



AIRHEAD STORM II is truly a state of the art towable. No other 2 rider towable provide this unparalleled combination of excitement, stability and comfort. STORM's wide wingspan and thick front profile allow it to glide effortlessly across big wakes. A neoprene seat pad is provided for each rider. Nylon wrapped handles with neoprene knuckle guards ensure a great grip. The durable RF welded 30 gauge PVC bladder is fully covered by rugged double-stitched 840 denier nylon. When it's time to relax, STORM II doubles as the world's most comfortable floating lake couch!

86" x 75" (deflated)

PART #	MFG #	U/M	DESCRIPTION		
966249	AHST-2	EA	AIRHEAD STORM II	319.99	J

## STORM III™ INFLATABLE TRIPLE RIDER TOWABLE



AIRHEAD STORM III is truly a state of the art towable. No other 3 rider towable provide this unparalleled combination of excitement, stability and comfort. STORM's wide wingspan and thick front profile allow it to glide effortlessly across big wakes. A neoprene seat pad is provided for each rider. Nylon wrapped handles with neoprene knuckle guards ensure a great grip. The durable RF welded 30 gauge PVC bladder is fully covered by rugged double-stitched 840 denier nylon. When it's time to relax, STORM III doubles as the world's most comfortable floating lake couch!



116" x 75" (deflated)

PART #	MFG #	U/M	DESCRIPTION		
966251	AHST-3	EA	AIRHEAD STORM III	419.99	J



**AIRHEAD®  
TOWABLES**



**TRANSFORMER™**

70" x 75" (deflated size)

AIRHEAD TRANSFORMER is 2 tubes in one! It transforms from a deck tube to a cockpit tube in seconds! Young children will especially enjoy it in cockpit mode. The inflated floors and deluxe handles with neoprene knuckle guards will help them feel safe and secure. Teens and adults normally prefer a wilder deck tube ride. To transform this 2 rider towable from mild to wild, simply insert the 2 inflatable bladders to fill the cockpit and roll the neoprene pads into place. If you have 1 small child and a teen or adult, you can mix it up and ride one side cockpit, the other deck! Transformer is built to last from rugged 840 denier nylon and 30 gauge vinyl. The heavy duty Kwik-Connect and Boston valve provide quick and easy rope hook-ups, inflating and deflating.



PART #	MFG #	U/M	DESCRIPTION		
966256	AHTF-2	EA	AIRHEAD TRANSFORMER	299.99	J

- accessories
- towables**
- body
- controls
- electrical
- driveline
- engine
- fuel & intake
- chemicals
- tie downs
- tools
- towing & loading

**TRANSFORMER 3  
INFLATABLE TRIPLE RIDING TUBE**

112" x 92" (deflated size)



AIRHEAD TRANSFORMER is 3 tubes in one! Designed for 1 to 3, ride it deck-deck-deck, cockpit-deck-cockpit or cockpit-deck-deck! The center rider lies down, deck tube style. The outside riders can choose to also ride lying on the soft comfortable pads. Simply remove the inflatable inserts and roll up the deck pads in seconds and transform it into a recumbent cockpit! Young children will especially enjoy the safety and security of cockpit mode. The inflated floors and deluxe handles with neoprene knuckle guards will help them feel safe and secure. Teens and adults normally prefer a wilder deck tube ride. Transformer 3 is built to last, with rugged double-stitched 840 denier nylon and 30 gauge vinyl bladders. The heavy duty Kwik-Connect and patented Speed Safety Valve provide quick and easy rope hook-ups, inflating and deflating.

PART #	MFG #	U/M	DESCRIPTION		
966257	AHTF-3	EA	AIRHEAD TRANSFORMER 3	459.99	J

**TRANSFORMER 4  
INFLATABLE FOUR RIDER TOWABLE**

AIRHEAD TRANSFORMER 4 is 4 tubes in 1, providing fun to 2, 3, 4, 5 or 6 riders at once! It's a comfortable 4 rider round "sit in" towable, a 2 rider deck style towable, a 3 rider deck style towable and a great "over the transom" lounge! The humongous "sit in" towable is 88" diameter, an inflatable seat for 4, 8 heavy duty tubular webbing handles with knuckle guards, and a Kwik-Connect tow attachment. The deck tube is 58 in diameter and equipped with the 4 deluxe nylon-wrapped handles with neoprene knuckle guards provide a sure and comfortable grip. Both towables are equipped with a Speed Safety Valve that provides the ultimate in inflating and deflating convenience.

Size: 88" large deck or sit in (deflated) 58" small deck (deflated)

PART #	MFG #	U/M	DESCRIPTION		
966660	AHTF-4	EA	AIRHEAD TRANSFORMER 4	429.99	J



MARINE

# AIRHEAD

## AIRHEAD® TOWABLES

- accessories
- towables
- body
- controls
- electrical
- driveline
- engine
- fuel & intake
- chemicals
- tie downs
- tools
- towing & loading



### BLAST® INFLATABLE ONE PERSON TOWABLE

You'll have a real blast on Airhead Blast! The 4 neoprene knuckle guards and deluxe nylon covered handles provide a sure and comfortable grip. The heavy-duty virgin PVC bladder has electronically welded seams and a Boston valve for quick inflating and deflating. Blast has a double stitched nylon cover, reinforced internal tow harness and a self-draining floor vent. You'll love the eye-catching graphics on this 1 rider 54" (deflated) round towable!

PART #	MFG #	U/M	DESCRIPTION		
966661	AHBL-12	EA	AIRHEAD BLAST	82.99	J

### TURBO BLAST®

TURBO BLAST is not only a head turner, it is one hot riding tube! The 90" x 56" (deflated) double open top tube has a rugged double stitched 840-denier nylon cover with 2 self-draining floor vents. The 30-gauge virgin PVC bladder is equipped with a Boston valve, the ultimate in inflating and deflating convenience. Four deluxe handles with neoprene knuckle guards ensure a comfortable grip. You'll really appreciate the heavy-duty Kwik-Connect every time you hook-up your tow rope.



PART #	MFG #	U/M	DESCRIPTION		
966662	AHTB-12	EA	AIRHEAD TURBO BLAST	169.99	J

# MARINE



### BIG SHOT® INFLATABLE FOUR RIDER TOWABLE

Think BIG SHOT for big time fun! This stunning 4 rider towable glides across wakes with the greatest of ease, despite its humongous 76" (deflated) size! BIG SHOT has 8 deluxe handles with neoprene knuckle guards. A heavy-duty Kwik-Connect makes rope connections a breeze.



The rugged 30-gauge virgin PVC bladder and double-stitched nylon cover with a self draining floor vent to ensure years of enjoyment. You'll really appreciate the AIRHEAD Multi-Valve for the ultimate in inflating and deflating convenience.

PART #	MFG #	U/M	DESCRIPTION		
966424	BS-1	EA	AIRHEAD BIG SHOT	174.99	J

**AIRHEAD®  
TOWABLES**



**LIVE WIRE 2**

With a variety of different riding options, AIRHEAD LIVE WIRE comes alive with energy on the water! Featuring dual tow points, 2 riders can ride sitting down using the comfy backrest and large roomy cockpit, or tow it the opposite direction for a kneeling chariot style ride you'll never forget. A multitude of comfortable foam filled nylon handles with neoprene knuckle guards facilitate different riding positions. The fun graphics make this uniquely shaped towable dressed to impress. Equipped with patented Speed Safety Valves for fast easy inflating and deflating. The Kwik Connect tow point provides easy hook-ups. Heavy gauge RF welded vinyl bladder and double-stitched full nylon cover, self-bailing drain vents.



PART #	MFG #	U/M	DESCRIPTION		
966686	AHLW-2	EA	AIRHEAD LIVE WIRE 2	349.99	J

**LIVE WIRE 3**

With a variety of different riding options, AIRHEAD LIVE WIRE comes alive with energy on the water! Featuring dual tow points, 3 riders can ride sitting down using the comfy backrest and large roomy cockpit, or tow it the opposite direction for a kneeling chariot style ride you'll never forget. A multitude of comfortable foam filled nylon handles with neoprene knuckle guards facilitate different riding positions. The fun graphics make this uniquely shaped towable dressed to impress. Equipped with patented Speed Safety Valves for fast easy inflating and deflating. The Kwik Connect tow point provides easy hook-ups. Heavy gauge RF welded vinyl bladder and double-stitched full nylon cover, self-bailing drain vents.



PART #	MFG #	U/M	DESCRIPTION		
966687	AHLW-3	EA	AIRHEAD LIVE WIRE 3	429.99	J

- accessories
- towables**
- body
- controls
- electrical
- driveline
- engine
- fuel & intake
- chemicals
- tie downs
- tools
- towing & loading

**MARINE**



## AIRHEAD® TOWABLES

### ROCK STAR™ INFLATABLE TRIPLE RIDER TOWABLE

You've always wanted to be a rock star, now here's your chance! Not only does this awesome 3 rider U-shaped towable glide effortlessly across the wake, it also rocks! With a slight turn of the boat, the inside wing teeters towards the wake as the outside wing rises high above the water! It also doubles as a super fun rocking swim platform. The durable double-stitched 840 denier nylon cover and rugged 30 gauge PVC inner bladder ensure long service. The heavy duty Kwik-Connect and Boston valve provide quick and easy rope hook-ups, inflating and deflating.



PART #	MFG #	U/M	DESCRIPTION	
966214	AHRS-3	EA	AIRHEAD ROCK STAR	329.99 J



81" x 78" (deflated)

### MEGA ROCK STAR® INFLATABLE QUADRUPLE RIDER TOWABLE

This towable is a real blast for 1 to 6 riders! The U-shape allows it to effortlessly cross wakes. The rocking motion adds a lot of excitement! There are so many ways to ride MEGA ROCK STAR! The sides comfortably accommodate 2 riders lying down or 4 riders kneeling. Add 2 more riders on the center "hump" and you've got a super fun 6 rider towable! Oversized neoprene pads are strategically placed to protect knees and elbows. Fourteen nylon handles with neoprene knuckle guards ensure a great grip for all riders. Durable double-stitched 840 denier nylon cover and rugged 30 gauge K80 PVC inner bladder. The Boston valve easy inflating and deflating.



PART #	MFG #	U/M	DESCRIPTION	
966215	AHRS-6	EA	AIRHEAD MEGA ROCK STAR	419.99 J



82" x 78" (deflated)

- accessories
- towables
- body
- controls
- electrical
- driveline
- engine
- fuel & intake
- chemicals
- tie downs
- tools
- towing & loading

**AIRHEAD®  
TOWABLES**



**MATRIX™ V-2  
INFLATABLE DOUBLE RIDER  
TOWABLE**

PART #	MFG #	U/M	DESCRIPTION
966193	AHMX-V2	EA	AIRHEAD MATRIX V-2 239.99 J



Get way up on edge with MATRIX! These U-shaped winged towables roll way up on edge when riders shift their weight. The wings also make them a joy to tow, they slide effortlessly across wakes. No expense was spared in MATRIX's state-of-the-art construction. They're thicker at the front to prevent submarining and thin at the back to make it easier to climb on from the water. The deluxe handles have neoprene knuckle guards. Two oversized neoprene pads are strategically located to protect knees and elbows. The durable 30 gauge RF welded PVC bladder is completely wrapped in double-stitched 840-denier nylon. A heavy-duty Kwik-Connect provides easy hook-ups and the Boston valve makes it easy and fast to deflate and inflate.



2 Rider  
73" x 61"



**MATRIX™ V-3  
INFLATABLE TRIPLE RIDER  
TOWABLE**

Get way up on edge with MATRIX! These U-shaped winged towables roll way up on edge when riders shift their weight. The wings also make them a joy to tow, they slide effortlessly across wakes. No expense was spared in MATRIX's state-of-the-art construction. They're thicker at the front to prevent submarining and thin at the back to make it easier to climb on from the water. The deluxe handles have neoprene knuckle guards. Two oversized neoprene pads are strategically located to protect knees and elbows. The durable 30 gauge RF welded PVC bladder is completely wrapped in double-stitched 840-denier nylon. A heavy-duty Kwik-Connect provides easy hook-ups and the Boston valve makes it easy and fast to deflate and inflate.

PART #	MFG #	U/M	DESCRIPTION
966194	AHMX-V3	EA	AIRHEAD MATRIX V-3 309.99 J



3 Rider  
87" x 68"

- accessories
- towables**
- body
- controls
- electrical
- driveline
- engine
- fuel & intake
- chemicals
- tie downs
- tools
- towing & loading

**MARINE**

- accessories
- towables
- body
- controls
- electrical
- driveline
- engine
- fuel & intake
- chemicals
- tie downs
- tools
- towing & loading

# AIRHEAD

## AIRHEAD® TOWABLES

### FUSION 2 INFLATABLE TRIPLE RIDER TOWABLE



Cockpit-style towables are great for small children, because they feel secure sitting inside. Teenagers love the wild ride of a deck tube. AIRHEAD FUSION is a revolutionary new tube design, it's both a cockpit tube and a deck tube! The roomy center cockpit is equipped with a nylon covered inflatable floor and headrest. The side deck areas have strategically placed neoprene panels for comfort and performance. Two inflatable fins are strategically placed to help riders stay on the tube. A Kwik-Connect and Boston valve provide the ultimate in connecting, inflating and deflating convenience. The durable 30 gauge PVC bladder is fully covered by rugged 840 denier nylon. Dimensions are 71 in. x 87 in. (deflated). Patent pending.

**Features:**

- Multi-functional design- cockpit and deck tube
- 2 Neoprene body pads
- Inflated floor and backrest in cockpit
- 2 Inflatable stabilizer fins keep riders on board
- Heavy-Gauge PVC Bladder with RF welded seams
- Double-Stitched Full Nylon Cover
- Deluxe nylon handles with neoprene knuckle guards
- Kwik-Connect tow point for fast hook-ups
- Boston Valve for convenient inflating and deflating
- 3 Rider capacity
- 71 in. x 87

PART #	MFG #	U/M	DESCRIPTION	
968112	AHFN-12	EA	AIRHEAD FUSION 2	329.99 J



### HOT SHOT 2 INFLATABLE SINGLE RIDER TOWABLE

Come on Hot Shot, show us what you've got! If you like air time, you won't be disappointed! HOT SHOT, AIRHEAD's 57" (deflated) round deck tube is one hot ride, built to last and a great value. The rugged PVC bladder is completely covered with a double-stitched nylon cover. The thin profile makes it easy to climb onto from the water. HOT SHOT has 4 deluxe handles with neoprene knuckle guards and is equipped with a Speed Safety Valve for quick inflating and deflating. Designed for 1 adult or 2 small children.

- Round thin profile deck tube
- Heavy-Gauge PVC Bladder with RF welded seams
- Double-Stitched Full Nylon Cover
- Deluxe nylon handles with neoprene knuckle guards
- Speed Safety Valve for convenient inflating and deflating
- Reinforced internal tow harness
- 1 Rider capacity
- 57 in. diameter (deflated)

PART #	MFG #	U/M	DESCRIPTION	
968113	AHHS-12	EA	AIRHEAD HOT SHOT 2	109.99 J

**AIRHEAD®  
TOWABLES**



**RIPTIDE 2 & RIPTIDE 3**

RIPTIDEs are a great value for tubes that feature a wrap-around backrest for that “couch-like” ride. These tubes are incredibly lively side to side, requiring very little effort from the boat driver to get them to cross the wake. Equipped with a Kwik-Connect for easy rope attachments and disconnects. RIPTIDEs feature comfortable seat pads and foam-filled tubular webbing handles with neoprene knuckle guards for firm and comfortable hand holds. Two patented Speed Safety Valves provide the ultimate in inflation and deflation convenience.

**Features:**

- Wrap Around Backrests
- Double Webbing Foam Handles with Knuckle Guards
- Patented Speed Safety Valve
- Self Bailing Drain Vents
- Reinforced Tow System
- Heavy-Duty Full Nylon Cover
- Heavy-Duty K80 PVC Bladders
- Kwik-Connect Tow Point



**RIPTIDE 2**

Cover	Full Nylon
Max Capacity	2 Riders
Length X Width (deflated)	65 in. x 65 in.
Tow Point	Kwik Connect

PART #	MFG #	U/M	DESCRIPTION		
968117	AHRT-12	EA	AIRHEAD RIPTIDE 2	229.99	J



**RIPTIDE 3**

Cover	Full Nylon
Max Capacity	3 Riders
Length X Width (deflated)	85 in. x 70 in.
Tow Point	Kwik Connect

PART #	MFG #	U/M	DESCRIPTION		
968118	AHRT-13	EA	AIRHEAD RIPTIDE 3	299.99	J



- accessories
- towables**
- body
- controls
- electrical
- driveline
- engine
- fuel & intake
- chemicals
- tie downs
- tools
- towing & loading

**MARINE**



- accessories
- towables
- body
- controls
- electrical
- driveline
- engine
- fuel & intake
- chemicals
- tie downs
- tools
- towing & loading

### STRIKE

STRIKE is an incredible value for a fully covered deck tube! It's a 1 rider 54" (deflated) round towable with 4 nylon wrapped handles and neoprene knuckle guards. The RF welded PVC bladder is fully encased by a durable double-stitched nylon cover. STRIKE is equipped with a Speed Safety valve for easy inflation and deflation, covered flap for safety



PART #	MFG #	U/M	DESCRIPTION		
968127	AHST-23	EA	AIRHEAD STRIKE	99.99	J

### G-FORCE® 2 INFLATABLE DOUBLE RIDER TOWABLE

G-Force is a wild ride for up to 2 thrill-seekers! Defy centrifugal force with G-Force's topside stabilizer fins. The 4 deluxe nylon-wrapped handles with neoprene knuckle guards provide a sure and comfortable grip. G-Force has a tough heavy gauge virgin PVC bladder, fully covered with a durable double-stitched nylon cover. G-Force is 64" x 60" (deflated) and is equipped with a heavy-duty Kwik-Connect for easy and secure hook-ups. A Speed Safety Valve provides the ultimate in inflation and deflation convenience.



PART #	MFG #	U/M	DESCRIPTION		
966471	AHGF-2	EA	AIRHEAD G-FORCE 2	189.99	J

### G-FORCE® 3 INFLATABLE TRIPLE RIDER TOWABLE

G-Force is a wild ride for up to 3 thrill-seekers! Defy centrifugal force with G-Force's topside stabilizer fins. The 6 deluxe nylon-wrapped handles with neoprene knuckle guards provide a sure and comfortable grip. G-Force has a tough 30-gauge virgin PVC bladder, fully covered with an 840-denier double-stitched nylon cover. G-Force is 78" x 75" (deflated) and is equipped with a heavy-duty Kwik-Connect for easy and secure hook-ups. A Speed Safety Valve provides the ultimate in inflation and deflation convenience.



PART #	MFG #	U/M	DESCRIPTION		
966672	AHGF-3	EA	AIRHEAD G-FORCE 3	229.99	G



**AIRHEAD®  
TOWABLES**



**OUTRIGGER™  
INFLATABLE TRIPLE RIDER  
TOWABLE**

The concave bottom on OUTRIGGER makes for one wild ride! The tube of choice for choppy water because it rides on its rails. Two oversized topside neoprene panels protect elbows and knees. The 2 inflated fins on the perimeter really help riders stay on top. The OUTRIGGER also rocks backwards for easy reboarding from the water. Six deluxe handles with neoprene knuckle guards provide a great grip for 1, 2 or 3 riders. The heavy duty Kwik-Connect and Boston valve provide quick and easy rope hook-ups, inflating and deflating.



89.5" x 76" (deflated)

PART #	MFG #	U/M	DESCRIPTION	
966195	AHOU-3	EA	AIRHEAD OUTRIGGER	349.99 J



80" (deflated)

**REVOLUTION®  
INFLATABLE DOUBLE RIDER  
SPINNING TOWABLE**

Outrageous 2 Rider Spinning Towable AIRHEAD REVOLUTION provides unparalleled spinning fun for 2 riders. Lie down or sit up, either way, you're going to spin like there's no tomorrow! The strategically placed inflatable topside divider fin and 2 leg holding fins keep you from getting thrown off by centrifugal force. You're too old to enjoy spinning? Just thread the tow rope through the No Spin Strap and enjoy a mild ride. At the center of the bottom you'll find the tow point, a heavy duty stainless steel swivel. It's held in place with Kevlar strapping sewn to multiple layers of heavy gage tarpaulin material. REVOLUTION is built to last; a rugged 840 denier nylon cover fully covers the high impact 30 gauge K80 PVC bladder inside. Two neoprene panels and 8 handles with neoprene knuckle guards contribute to a comfortable ride. A Boston valve provides quick inflation and deflation.

PART #	MFG #	U/M	DESCRIPTION	
966209	AHRE-2	EA	AIRHEAD REVOLUTION	349.99 J

**SWITCHBACK  
INFLATABLE FOUR RIDER  
TOWABLE**

AIRHEAD SWITCHBACK is a new and exciting 4 rider towable. Two riders sit in front with a comfortable inflatable backrest and side panels to keep them in place. The other 2 riders kneel behind them, riding chariot style. It's a totally different sensation riding in front or back, so it's like 2 tubes in 1, consequently the name SWITCHBACK! This deluxe towable slides effortlessly across the wake. There are plenty of boarding straps for re-boarding from the water. SWITCHBACK features 2 heavy gauge PVC bladders and a rugged double stitched nylon cover to ensure long service. Inflation and deflation is easy with the two patented Speed Safety Valves.



88" x 70" (deflated)

PART #	MFG #	U/M	DESCRIPTION	
966657	AHSB-4	EA	AIRHEAD SWITCHBACK	449.99 J

- accessories
- towables
- body
- controls
- electrical
- driveline
- engine
- fuel & intake
- chemicals
- tie downs
- tools
- towing & loading



## AIRHEAD® TOWABLES

- accessories
- towables
- body
- controls
- electrical
- driveline
- engine
- fuel & intake
- chemicals
- tie downs
- tools
- towing & loading



### SLICE® DOUBLE RIDER TOWABLE

You'll really slice up the water with this 58 in. diameter (deflated) low profile towable! Peak performance is guaranteed with SLICE's topside neoprene panel, 4 nylon-wrapped handles and neoprene knuckle guards. The durable 30-gauge virgin PVC bladder is fully encased by a double-stitched nylon cover with a reinforced internal tow harness. SLICE is equipped with a super-convenient Kwik-Connect for easy hook-ups and a Boston valve for fast inflating and deflating. It's easy to climb onto SLICE from the water; it's tapered to only 6 in. high at the back. Designed for 1 or 2 riders.

PART #	MFG #	U/M	DESCRIPTION		
966223	AHSL-4W	EA	AIRHEAD SLICE	149.99	J

### SUPER SLICE™ TRIPLE RIDER TOWABLE

SUPER SLICE, AIRHEAD's high performance 3 rider low profile deck tube, will take your breath away! It's got an oversized topside neoprene body panel and 6 deluxe handles with neoprene knuckle guards, an Airhead exclusive. The 30-gauge virgin PVC bladder is fully encased by a rugged double-stitched nylon cover. SUPER SLICE is equipped with a heavy duty Kwik-Connect and Boston valve for the ultimate in convenience. It's tapered in back to only 6 inches, for easy boarding from the water. 70 inch diameter (deflated size).

PART #	MFG #	U/M	DESCRIPTION		
966245	AHSSL-1	EA	AIRHEAD SUPER SLICE	199.99	J



### MEGA-SLICE™ QUADRUPLE RIDER TOWABLE

MEGA-SLICE is the colossal 100 inch diameter (deflated size) member of AIRHEAD SLICE-series, the industry standard in deck tubes. The exclusive tapered profile, thick at the front and thin at the back, enhances your tubing experience. The thicker front allows a more natural and comfortable rider position and prevents "submarining". It's super easy to climb onto MEGA-SLICE from the water because it's thin at the back and has 5 boarding straps to grab onto. The 8 deluxe handles with neoprene knuckle guards provide a great grip for 1, 2, 3 or 4 riders. An Indy Cap covers the Boston valve. Connect MEGA-SLICE to an AIRHEAD Tube Anchor and you have an instant swim platform!

PART #	MFG #	U/M	DESCRIPTION		
966246	AHSSL-4	EA	AIRHEAD MEGA SLICE	329.99	J



**AIRHEAD®  
TOWABLES**



**HEXSANITY  
INFLATABLE DOUBLE RIDER  
TOWABLE**



AIRHEAD HEXSANITY's hexagon shape provides a wild ride, yet it's very stable and comfortable. With HEXSANITY's Dual Tow Points, attach your tow rope to the front Kwik-Connect with 1 or 2 riders sitting down, enjoying unparalleled support from the wrap-around backrests. Hook the tow rope to the rear Kwik-Connect to ride in a sportier kneeling position. When the tubing action is over and it's time to chill, lounge comfortably on HEXSANITY, it's as comfortable as your living room couch. Be sure to bring a drinks! HEXSANITY has 2 molded drink holders in the center. Four foam filled tubular nylon handles with neoprene knuckle guards provide firm and comfortable hand holds. Two patented Speed Safety Valves provide the ultimate in inflation and deflation convenience. HEXSANITY has a tough 30-gauge PVC bladder, fully covered with an 840-denier double-stitched nylon cover. It measures 85 x 77 in. (deflated) and is equipped with two heavy-duty Kwik-Connect for easy and secure hook-ups.

PART #	MFG #	U/M	DESCRIPTION		
966616	AHHX-2	EA	AIRHEAD HEXSANITY	449.99	J

**SLIDE®  
INFLATABLE SINGLE RIDER  
TOWABLE**

Believe it or not, there is a group of young men in Indiana trying to make tubing an Olympic sport! Their favorite tube for outrageous tricks? SLIDE, AIRHEAD's 1 rider, 56 in. (deflated) triangular tube. They enjoy a secure and comfortable grip with the 4 deluxe nylon-wrapped handles and neoprene knuckle guards. The heavy-duty virgin vinyl inner tube is electronically welded and equipped with a Boston valve for quick inflating and deflating. The double-stitched nylon cover has a heavy-duty internal tow harness and self-draining vent.



PART #	MFG #	U/M	DESCRIPTION		
966220	AHSL-12	EA	AIRHEAD SLIDE	89.99	J

**TREMOR**



89" diameter (deflated)



AIRHEAD TREMOR's unique wrap-around horseshoe shape is shaking up the tubing world! It features multi-level circular riding. Kneel on the soft knee pads and ride looking out or sit on top looking in. Designed for 1, 2, 3 or 4 riders, it makes a great floating conversation pit too! Put a cooler in the center and have a party! TREMOR has a tough 30-gauge PVC bladder, fully covered with an 840-denier double-stitched nylon cover. Equipped with a heavy-duty Kwik-Connect for easy and secure hook-ups. Eight foam filled tubular nylon handles with neoprene knuckle guards are strategically positioned for peak performance. Two patented Speed Safety Valves provide the ultimate in inflation and deflation convenience.

PART #	MFG #	U/M	DESCRIPTION		
966275	AHTM-4	EA	AIRHEAD TREMOR	469.99	J

- accessories
- towables
- body
- controls
- electrical
- driveline
- engine
- fuel & intake
- chemicals
- tie downs
- tools
- towing & loading

MARINE



## AIRHEAD® TOWABLES

- accessories
- towables
- body
- controls
- electrical
- driveline
- engine
- fuel & intake
- chemicals
- tie downs
- tools
- towing & loading

### VIPER 1

AIRHEAD's VIPER-series is a collection of the finest cockpit-style towables that your money can buy. The bottoms are shaped like boat hulls which is the key to the unparalleled lively and stable ride. VIPERs are especially popular with young children, as they feel very safe sitting on the comfortable inflated floors inside the cockpits. Kids and adults will enjoy the stunning NASCAR-inspired graphics. The durable 30 gauge bladders are completely encased in durable double-stitched nylon, there is no exposed PVC. The striped nylon wrap handles have neoprene knuckle guards for comfort. An EVA "Indy Cap" covers the Boston valve. 1 rider, 67 in. x 51 in.



PART #	MFG #	U/M	DESCRIPTION		
966290	AHVI-F1	EA	AIRHEAD VIPER, 1 RIDER	199.99	H

### VIPER 2

AIRHEAD's VIPER-series is a collection of the finest cockpit-style towables that your money can buy. The bottoms are shaped like boat hulls which is the key to the unparalleled lively and stable ride. VIPERs are especially popular with young children, as they feel very safe sitting on the comfortable inflated floors inside the cockpits. Kids and adults will enjoy the stunning NASCAR-inspired graphics. The durable 30 gauge bladders are completely encased in durable double-stitched nylon, there is no exposed PVC. The striped nylon wrap handles have neoprene knuckle guards for comfort. An EVA "Indy Cap" covers the Boston valve. 2 rider, 69 in. x 67 in.



PART #	MFG #	U/M	DESCRIPTION		
966291	AHVI-F2	EA	AIRHEAD VIPER, 2 RIDER	299.99	J

### VIPER 3

AIRHEAD's VIPER-series is a collection of the finest cockpit-style towables that your money can buy. The bottoms are shaped like boat hulls which is the key to the unparalleled lively and stable ride. VIPERs are especially popular with young children, as they feel very safe sitting on the comfortable inflated floors inside the cockpits. Kids and adults will enjoy the stunning NASCAR-inspired graphics. The durable 30 gauge bladders are completely encased in durable double-stitched nylon, there is no exposed PVC. The striped nylon wrap handles have neoprene knuckle guards for comfort. An EVA "Indy Cap" covers the Boston valve. 3 rider 93" x 67"



PART #	MFG #	U/M	DESCRIPTION		
966292	AHVI-F3	EA	AIRHEAD VIPER, 3 RIDER	419.99	H

## AIRHEAD® TOWABLES



### BIG DOGS

You've ridden these classic "banana" inflatables at beach resorts, having the time of your life; now it's time to actually own a commercial grade BIG DOG! All seams are hot air overlap welded to increase durability. The double reinforced tow harness is equipped with two 316 stainless steel rings and a 316 stainless swivel to prevent twisting and damage to the tow rope. They're constructed of UV resistant 31 oz. 1000 denier polyester mesh reinforced PVC and equipped with double reinforced seat pads, heavy duty handles with knuckle guards and 3 H style valves. A carry bag and a foot pump for inflating and deflating are included.

966658: 17' 4" long x 5' wide (deflated), maximum weight capacity: 1,000 lbs.  
966659: 19' 3" long x 5' wide (deflated), maximum weight capacity: 1,200 lbs.



PART #	MFG #	U/M	DESCRIPTION		
966658	AHBD-5	EA	AIRHEAD BIG DOG 5	999.00	J
966659	AHBD-6	EA	AIRHEAD BIG DOG 6	1199.00	J



### JUMBO DOG™

Monster dog is more like it! You'll have the time of your life on this "water weenie" designed for 1 to 5 riders. JUMBO DOG has deluxe nylon-wrapped handles. The neoprene knuckle guards and seat pads are for comfort and to help you stay on top. It's a whopping 12 long x 49 inches wide (deflated). Rope hook-ups are super easy with the heavy-duty Kwik-Connect. Three 30-gauge vinyl air chambers are fully encased by a double stitched 1,680-denier nylon cover. JUMBO DOG is equipped with a Boston valve for the ultimate in inflating and deflating convenience.

PART #	MFG #	U/M	DESCRIPTION		
966470	HD-5	EA	JUMBO DOG	379.99	J

### DOUBLE DOG™

We double dog dare you to climb on, hang on and have some serious fun! DOUBLE DOG is built to last; the 30-gauge PVC bladder is completely covered in double-stitched 840-denier nylon, with no exposed vinyl. It has 2 deluxe handles with neoprene knuckle guards and seat pads. The Boston valve is easily accessible, for quick inflating and deflating. Size: 79" long x 49" wide (deflated).



PART #	MFG #	U/M	DESCRIPTION		
966468	HD-2	EA	DOUBLE DOG	159.99	J

### HOT DOG®

You'll have the time of your life on this "water weenie" designed for 1 to 3 riders. HOT DOG has deluxe nylon-wrapped handles with neoprene knuckle guards. There are three neoprene seat pads for comfort and to help you stay on top. It's a whopping 8-1/2 ft. long x 49" inches wide. Rope hook-ups are super easy with the heavy-duty Kwik-Connect. Three 30-gauge vinyl air chambers are fully encased by a double stitched 840-denier nylon cover. It's equipped with an Boston valve for the ultimate in inflating and deflating convenience.



PART #	MFG #	U/M	DESCRIPTION		
966469	HD-3	EA	HOT DOG	229.99	J

### QUAD DOG®

Our classic HOT DOG series just got better with the first tandem ride! You can now enjoy more stability on this "water weenie" designed for 4 riders. QUAD DOG has deluxe nylon-wrapped handles with neoprene knuckle guards. There are four neoprene seat pads for comfort and to help you stay on top. The turned-up nose knives through the water like butter and prevents submarining. The whole family can enjoy this tandem rodeo-style ride. Rope hook-ups are super easy with the heavy-duty Kwik-Connect. Five 30-gauge vinyl air chambers are fully encased by a double stitched 840-denier nylon cover. It's equipped with our patented Speed Valves for inflating and deflating convenience. \*Deflated size: 79" x 77"



PART #	MFG #	U/M	DESCRIPTION		
968160	HD-4	EA	QUAD DOG	314.99	J



- accessories
- towables
- body
- controls
- electrical
- driveline
- engine
- fuel & intake
- chemicals
- tie downs
- tools
- towing & loading

MARINE

# TOWABLES

# AIRHEAD

## AIRHEAD® TOWABLES

accessories

towables

body

controls

electrical

driveline

engine

fuel & intake

chemicals

tie downs

tools

towing & loading

### MACH 1™

We recommend cockpit tubes like MACH 1 for young riders, since they feel very secure inside. MACH 1 provides a wild but stable ride for all ages including young children, teens and adults. Comfort is guaranteed by the inflated floor and deluxe handles with neoprene knuckle guards. The heavy gauge PVC bladder and durable double-stitched nylon cover ensure years of service. Equipped with a Boston Valve and Kwik-Connect for quick and easy inflating, deflating and rope hook-ups. 68 in. x 50 in. (deflated size).

PART #	MFG #	U/M	DESCRIPTION		
966188	AHM1-1	EA	AIRHEAD Mach 1	159.99	J



### MACH 2

MACH 2 is our budget minded 2 rider cockpit towable. We recommend cockpit tubes for timid and young riders, since they feel very secure inside. MACH 2 also has a wild side, making teens and adults happy too. The inflated floors provide a comfortable seat. Four deluxe handles with neoprene knuckle guards provide a secure and comfortable grip. The heavy gauge PVC bladder and durable double-stitched nylon cover ensure years of service. Equipped with a patented Speed Safety Valve for easy inflating and deflating. 69 x 69 in.

PART #	MFG #	U/M	DESCRIPTION		
966189	AHM2-2	EA	AIRHEAD Mach 2	219.99	J



### AIRHEAD® WAKE SURF

DOUBLES AS A KAYAK!

Riders ride inline, like an on the water bobsled on AIRHEAD's unique Wake Surf towables. Despite being quite stable, they rock side to side giving riders the exciting impression that they're going to spill at any second! They are great at riding the wave of the wake. The comfortable wrap-around backrests give great support. Neoprene seat pads and knuckle guards provide comfort and control. The durable double-stitched 840 denier nylon cover completely encases the 30 gauge K80 PVC bladder. The heavy duty Kwik-Connect and Boston valve provide quick and easy rope hook-ups, inflating and deflating. Doubles as a kayak, just grab a paddle or 2!  
966377: 90 in. x 46 in., 1 - 2 rider.  
966378: 122 in. x 47 in., 1 - 3 rider



PART #	MFG #	U/M	DESCRIPTION		
966377	AHWS-2	EA	AIRHEAD Wake Surf 2	199.99	L



MARINE

**AIRHEAD®  
LOUNGE & PLAY**



Dimensions 6 ft. x 10 ft. (deflated)

**GANG PLANK  
INFLATABLE MAT**

Walk on water with the amazing AIRHEAD GANG PLANK! Up to 6 people can walk the plank, or better yet, relax, and play on the inflatable mat all day long. The innovative design features a zippered connection system so you can link as many together as you want, for the ultimate party on the water! Constructed of tough 30 gauge PVC with 4 grommets to tether it to the lake bottom, your boat, dock or the shore. Featuring a reversible color scheme, the regal white side or opposite royal blue side will surely match your lake house or pool. Lounge with your friends in air cushioned comfort or get wild on Gang Plank.

PART #	MFG #	U/M	DESCRIPTION		
966682	AHGP-6	EA	AIRHEAD GANG PLANK	229.99	J



**AIRHEAD® LAZY LAGOON™**

Kick Back and relax with all your friends on the LAZY LAGOON inflatable island. The unique round seating configuration features a central swim opening in the middle to dip your toes in when it's time to cool off. The air cushioned wrap around backrest provides comfortable support and the 2 boarding handles make it simple to climb onboard from the water. There are 3 grommets around the perimeter to tie on a floating cooler, anchor to the bottom, or tether the island to a dock or shore. Inflate in no time with patented Speed Safety Valves and get lazy at the pool, lake or beach this summer. Dimensions: 102 in. diameter (deflated)

PART #	MFG #	U/M	DESCRIPTION		
966685	AHLL-1	EA	AIRHEAD LAZY LAGOON	219.99	J



**COOL ISLAND™**

Hang out on AIRHEAD's COOL ISLAND and have a party! Sunbathe on the roomy sundeck, then cool off splashing around in the mesh area. Four drink holders and a sundry holder, perfect for storing suntan lotion, are conveniently located between the wet and dry areas. The boarding platform makes it easy to climb on top from deep water. There are 3 handles welded to the sides for carrying. Two tie down points are strategically welded to the sides for anchoring. Designed for up to 6. Dimensions: 107" x 88" (deflated).

PART #	MFG #	U/M	DESCRIPTION		
966155	AHCI-1	EA	AIRHEAD COOL ISLAND	249.99	J



- accessories
- towables
- body
- controls
- electrical
- driveline
- engine
- fuel & intake
- chemicals
- tie downs
- tools
- towing & loading

MARINE



## AIRHEAD® LOUNGE & PLAY

### ARUBA LOUNGE

AIRHEAD's ARUBA LOUNGE is a comfortable pool and lake lounge with a mesh panel between pillows at each end. Lie down and stay cool suspended in the water by the comfortable mesh panel. Your drink will be close at hand in the molded drink holder. Tether ARUBA LOUNGE to your boat or tie 2 or more ARUBA Lounges together using the side mounted rope anchors. Durable vinyl construction with RF welded seams. Dimensions: 66 in. x 37 in. (deflated).



PART #	MFG #	U/M	DESCRIPTION	
966139	AHAL-1	EA	AIRHEAD ARUBA LOUNGE	31.99 J



### EZ BREEZE

EZ BREEZE's mesh seat is offset, not centered, which allows for easier boarding from the water and a very comfortable backrest. The top is clear and the tropical graphics are printed on the inside of the bottom for an incredible visual effect. There's a molded drink holder and a rope holder for tethering to a moored boat, dock or your friend's EZ BREEZE. This 48 in. (deflated) tube is built to last, with rugged RF welded 20 gauge K80 PVC construction. It's a good thing that EZ BREEZE has only 1 air chamber and is equipped with a patented Speed Safety Valve for quick and easy inflating and deflating. You'll want to take it everywhere!

PART #	MFG #	U/M	DESCRIPTION	
966159	AHEB-1	EA	AIRHEAD EZ BREEZE	37.99 J

### EZ BREEZE DUO

EZ BREEZE DUO's mesh seat is offset, not centered, which allows for easier boarding from the water and a very comfortable backrest. The top is clear and the tropical graphics are printed on the inside of the bottom for an incredible visual effect. Spend all day lounging on EZ BREEZE DUO, enjoying the insulated cool'er. There's 2 molded drink holders and a rope holder for tethering to a moored boat, dock or your friend's EZ BREEZE. This 84 x 47" (deflated) tube is built to last, with rugged RF welded 20 gauge K80 PVC construction. EZ BREEZE DUO is equipped with a patented Speed Safety Valve for quick and easy inflating and deflating.



PART #	MFG #	U/M	DESCRIPTION	
966160	AHEB-2	EA	AIRHEAD EZ BREEZE DUO	69.99 J

### FIJI FLOAT

Stay cool floating in a pool or lake, sitting on FIJI FLOAT's comfortable mesh seat. Your drink will be close at hand in the molded drink holder. Tether it to your boat or tie 2 or more FIJI FLOATs together using the side mounted rope anchors. Durable vinyl construction with RF welded seams. Dimensions: 48 in. x 43 in. (deflated).



PART #	MFG #	U/M	DESCRIPTION	
966165	AHFF-1	EA	AIRHEAD FIJI FLOAT	21.99 J

- accessories
- towables
- body
- controls
- electrical
- driveline
- engine
- fuel & intake
- chemicals
- tie downs
- tools
- towing & loading



**AIRHEAD®  
LOUNGE & PLAY**



- accessories
- towables**
- body
- controls
- electrical
- driveline
- engine
- fuel & intake
- chemicals
- tie downs
- tools
- towing & loading



**PONGO BONGO  
BEVERAGE PONG TABLE**

Beverage pong is a very popular game these days. There's no better place to play on a hot day than in the water! PONGO BONGO is a floating inflatable game table equipped with 12 cup holders on each side. Kids love carnival games and will play PONGO BONGO for hours. Durable heavy gauge vinyl construction. Hang it from a ceiling in your game room or tether it to a moored boat or dock with the 4 molded rope holders welded to the sides. When you're done playing, turn it over and use it as a pool float or air mattress. Ping pong balls included!

**Features:**

- Inflatable beverage pong game table
- 12 cup holders on each side
- Kids love carnival games and will play PONGO BONGO for hours
- Durable heavy gauge vinyl construction
- Hang it from a ceiling or tether it to a dock with the 4 molded rope holders
- Turn it over and use it as a pool float or air mattress
- Speed Safety Valve for fast inflating and deflating
- 2 Ping pong balls included
- 72" x. 40" (Inflated Size)



PART #	MFG #	U/M	DESCRIPTION		
966203	AHPB-1	EA	AIRHEAD PONGO BONGO Beverage Pong Table	59.99	J

**LOB THE BLOB  
INFLATABLE GAME**

PART #	MFG #	U/M	DESCRIPTION		
966684	AHLB-1	EA	AIRHEAD LOB THE BLOB	44.99	J

Everyone loves playing an exciting game of cornhole with their friends. Now you can bring the action to the water with LOB THE BLOB! This instant classic floating game will test your skill and luck at sinking the Blobs in the 10 in. hole. It's great for the whole family and portable to take anywhere you want to play. It's constructed of heavy gauge PVC with the Speed Safety Valve for fast and easy inflation and deflation. There are grommets on all four corners for tethering on land. Play LOB THE BLOB at your backyard barbecue or take it to the lake for a game in the sun while you stay cool in the water. 37 in. x 26 in. playing surface. Includes: 4 green blobs, 4 blue blobs and 1 target.



MARINE

# TOWABLES

## AIRHEAD®

### AIRHEAD® LOUNGE & PLAY

#### AQUA OASIS™

You don't have to interrupt the party to restock the cooler with AIRHEAD's AQUA OASIS. The insulated leak-proof nylon cooler lifts up from the inflatable vinyl base and has an adjustable shoulder strap. It keeps 24 cans ice cold for hours. The 6 drink holders in the floating base are marked with numbers to help you and your friends keep track of your drinks. The sundry holder is a convenient place to store suntan lotion. A molded plastic rope connector is welded to the side for tethering to an AIRHEAD lounge, swim platform, boat or dock.



PART #	MFG #	U/M	DESCRIPTION		
966140	AHAO-1	EA	AIRHEAD AQUA OASIS	39.99	J



#### BIMINI LOUNGER II

Relax on the water in comfort with AIRHEAD's newly improved BIMINI LOUNGER II. There are only 3 air chambers to inflate, not 6 or 7 like the other brands! Float with your legs dangling in the water, or stretch them out on the folding inflatable leg rest. There's a cup holder for your cool drink and a zippered storage compartment for sun tan lotion and other necessities. The inflatable backrest ensures unparalleled comfort. Durable nylon construction with a heavy-gauge PVC bladder inside.



PART #	MFG #	U/M	DESCRIPTION		
966153	AHBL-3	EA	AIRHEAD BIMINI LOUNGER II	94.99	J

38"x 60" (deflated with leg rest extended)



#### U-LOUNGE

Connect 2, 3, 4 or more U-LOUNGES together for a lake or pool party! You and your friends will stay cool, no matter how hot the weather, floating in the comfortable mesh seat. Keep a cool drink close at hand in the molded cup holder. Quality built from heavy gauge PVC.

Dimensions: 44" x 32" x 12"



PART #	MFG #	U/M	DESCRIPTION		
966286	AHUL-1P	EA	AIRHEAD U LOUNGE, yellow/red	25.99	J
966287	AHUL-2P	EA	AIRHEAD U LOUNGE, zebra	25.99	J

#### HOOPLA - INFLATABLE SINGLE PERSON LOUNGE FLOAT

AIRHEAD HOOPLA is a high quality 42 inch (deflated) round swim ring. It is not a cheap pool toy. It's constructed of heavy gauge PVC and should last well beyond your expectations. HOOPLA is great for fun in pools, lakes and rivers.



PART #	MFG #	U/M	DESCRIPTION		
966173	AHHO-1	EA	AIRHEAD HOOPLA	11.99	J

**AIRHEAD®  
LOUNGE & PLAY**



**ROLLIN' RIVER**

What a great way to beat the heat, floating down a cool river with friends! This heavy gauge 2 chamber PVC tube is designed for rivers, lakes and pools. It's equipped with 2 RF-welded molded handles for riding in rough waters. 42 in. (deflated) diameter.

PART #	MFG #	U/M	DESCRIPTION		
966212	AHRR-1	EA	AIRHEAD ROLLIN' RIVER	20.99	J

**RIVER OTTER RIVER TUBE**

A great way to beat the heat! This heavy gauge PVC tube has 2 comfortable molded handles and is great for rivers, lakes and pools. Slip on the protective double stitched polyester cover for a stable trouble free float in rough waters. A molded drink holder ensures that you won't go thirsty on your float down the river. Two rope anchors are welded to the sides so that you can tether or link your RIVER OTTER to 2 or more friends for the ultimate river flotilla! Equipped with a Speed Safety Valve for quick inflating and deflating. 42" (deflated) diameter



PART #	MFG #	U/M	DESCRIPTION		
966688	AHRO-1	EA	AIRHEAD RIVER OTTER RIVER Tube	69.99	J

**RIVER OTTER DELUXE RIVER TUBE**

Since our original RIVER OTTER was such a success, we added a backrest to the Deluxe to enhance comfort as you go riding down the river. This heavy gauge PVC tube has 2 comfortable molded handles and is great for rivers, lakes and pools. Slip on the protective double stitched polyester cover for a stable trouble free float in rough waters. A molded drink holder ensures that you won't go thirsty on your float down the river! Two rope anchors are sewn to the sides so that you can tether or link your 2 or more RIVER OTTERS together for the ultimate river flotilla! Equipped with a Speed Safety Valve for quick inflating and deflating. 48 in. (deflated) diameter.



PART #	MFG #	U/M	DESCRIPTION		
968116	AHRO-2	EA	AIRHEAD RIVER OTTER DELUXE Tube	74.99	J

**RAGIN' RIVER - INFLATABLE SINGLE PERSON LOUNGE FLOAT**

RAGIN' RIVER is a luxurious river, lake and pool tube. The mesh seat panel and oversized backrest provide great support. Two drink holders ensure that you won't go thirsty on your float down the river. When the water gets rough, be sure to hold onto the molded handles. Two rope anchors are welded to the sides so that you can tether your RAGIN' RIVER to your powerboat or link 2 or more together for the ultimate river flotilla! Equipped with an extra large speed valve for quick inflating and deflating. 48 in. (deflated) diameter.



PART #	MFG #	U/M	DESCRIPTION		
966213	AHRR-2	EA	AIRHEAD RAGIN' RIVER	44.99	J

- accessories
- towables
- body
- controls
- electrical
- driveline
- engine
- fuel & intake
- chemicals
- tie downs
- tools
- towing & loading

MARINE

- accessories
- towables
- body
- controls
- electrical
- driveline
- engine
- fuel & intake
- chemicals
- tie downs
- tools
- towing & loading

## DESIGNER SERIES

AIRHEAD's Designer Series is an affordable way to dress up your pool! Color coordinate or mix and match the items and 3 designer colors, Aqua, Lime and Tangerine. Combine 2 Chairs with the Couch for an attractive, affordable conversation area! The combination possibilities are endless.

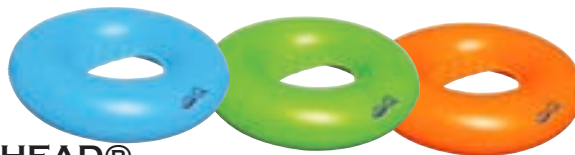

### AIRHEAD®

#### DESIGNER SERIES SEAT RING

AIRHEAD's Seat Ring is a round swim ring with an integrated air filled seat / backrest. It is not a cheap pool toy. It's constructed of heavy gauge vinyl and will last well beyond your expectations. The 44 inch diameter (deflated) Seat Ring is fun and comfortable and designed for use in pools, lakes and rivers. Available in 3 designer colors: Aqua, Lime or Tangerine.

PART #	MFG #	DESCRIPTION		
968094	AHDS-001	AIRHEAD Aqua Seat Ring	9.99	H
968095	AHDS-002	AIRHEAD Lime Seat Ring	9.99	H
968096	AHDS-003	AIRHEAD Tangerine Seat Ring	9.99	H

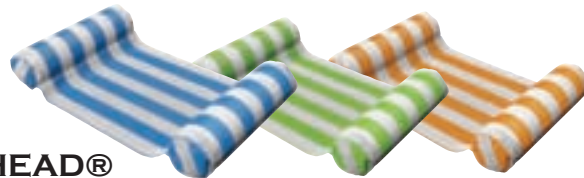

### AIRHEAD®

#### DESIGNER SERIES FLOATING HAMMOCK

AIRHEAD's floating hammock is incredibly comfortable and easy to stow in your boat, luggage or poolside storage. Tan and stay cool at the same time; lie down or sit up. The head and foot rests are quick and easy to inflate and deflate. Constructed of durable Textilene mesh for comfort and long service. 52 x 26 inches. Available in 3 designer colors: Aqua, Lime or Tangerine.

PART #	MFG #	DESCRIPTION		
968109	AHDS-016	AIRHEAD Aqua Hammock	29.99	G
968110	AHDS-017	AIRHEAD Lime Hammock	29.99	G
968111	AHDS-018	AIRHEAD Tangerine Hammock	29.99	G



### AIRHEAD®

#### DESIGNER SERIES FLOATING COUCH

Sit back and relax on AIRHEAD's comfy couch in a pool, lake, on shore or poolside! Three adults or up to 4 kids can share the couch enjoying the air cushioned comfort of the luxurious backrest. Constructed of heavy duty PVC for long service, the attractive shape allows plenty of room to spread out and enjoy tanning or reading a book with a friend. Equipped with 2 patented Speed Safety Valves for fast inflating and deflating with ease. 67" deflated diameter. Available in 3 designer colors: Aqua, Lime or Tangerine.

PART #	MFG #	DESCRIPTION		
968100	AHDS-007	AIRHEAD Aqua Couch	109.99	G
968101	AHDS-008	AIRHEAD Lime Couch	109.99	G
968102	AHDS-009	AIRHEAD Tangerine Couch	109.99	G

DESIGNER **airhead** SERIES



**AIRHEAD®**

**DESIGNER SERIES FLOATING CHAIR**

Add luxury to your pool, patio, lake or beach experience with the Airhead Chair. Use it on land or in the water, it's even more comfortable than it looks! Quench your thirst with a cool drink sitting in the molded cup holder. Features a sleek ergonomic backrest and thick, durable PVC construction. Equipped with a Speed Safety Valve for easy inflating and deflating. For 1 person, 47 in. deflated diameter. Available in 3 designer colors: Aqua, Lime or Tangerine.

PART #	MFG #	DESCRIPTION		
968103	AHDS-010	AIRHEAD Aqua Chair	25.99	G
968104	AHDS-011	AIRHEAD Lime Chair	25.99	G
968105	AHDS-012	AIRHEAD Tangerine Chair	25.99	G



**AIRHEAD®**

**DESIGNER SERIES FLOAT TUBE**

Relax, tan and stay cool on this super comfortable float. You'll love the simple design, comfortable mesh seat and headrest. Your drink will be close at hand, sitting inside the molded drink holder. Tether it to your boat or tie 2 or more floats together using molded rope eyelet. Constructed of durable RF welded vinyl construction to ensure long service. 48 in. x 43 in. (deflated). Available in 3 designer colors: Aqua, Lime or Tangerine.

PART #	MFG #	DESCRIPTION		
968097	AHDS-004	AIRHEAD Aqua Float	19.99	G
968098	AHDS-005	AIRHEAD Lime Float	19.99	G
968099	AHDS-006	AIRHEAD Tangerine Float	19.99	G



**AIRHEAD®**

**DESIGNER SERIES CHAISE LOUNGE**

The comfort of AIRHEAD's unique chaise will blow you away! For pools, lakes, at the beach or poolside, you'll love the head and neck comfort it provides as you spread out in the sun. The full length mesh keeps you cool and flexes for extra comfort. Keep a cool drink at your side in the molded drink holder. 76 x 35 in. (deflated). Available in 3 designer colors: Aqua, Lime or Tangerine.

PART #	MFG #	DESCRIPTION		
968106	AHDS-013	AIRHEAD Aqua Chaise	49.99	G
968107	AHDS-014	AIRHEAD Lime Chaise	49.99	G
968108	AHDS-015	AIRHEAD Tangerine Chaise	49.99	G

- accessories
- towables**
- body
- controls
- electrical
- driveline
- engine
- fuel & intake
- chemicals
- tie downs
- tools
- towing & loading

MARINE

# SUN COMFORT

AIRHEAD's SunComfort EcoCell foam is a long-lasting luxurious foam with rich color swirls throughout the entire products. It's more environmentally friendly than other foam lounges. It's 100% PVC Free with no harmful off-gassing or oils in contact with your skin. Simply put, SunComfort products don't stink like the others! Our specialized manufacturing processes yield a consistent size and shape product every time. The closed cell foam won't absorb water, crack, chip, peel, or tear. Soft to the touch and buoyant in your pool, they're lightweight and extremely durable for long service. Enjoy!

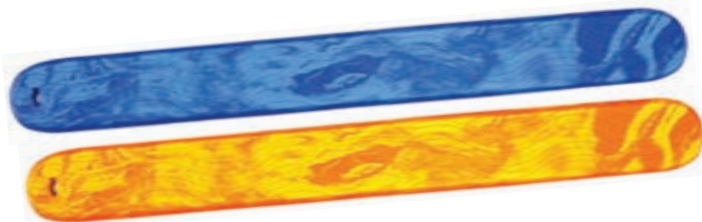

## AIRHEAD® SUNCOMFORT™ NOODLE

AIRHEAD's SunComfort Noodle provides hours of playtime for kids in the pool and is an effective buoyancy aid for all ages. Great for lakes and ocean too, so be sure to keep a bunch in your boat! Soft, luxurious and made from durable EcoCell foam. 45" x 5" x 1 3/4".

PART #	MFG #	DESCRIPTION		
968119	AHSC-001	SUNCOMFORT Noodle, Blue Swirl	11.99	J
968120	AHSC-002	SUNCOMFORT Noodle, Orange Swirl	11.99	J

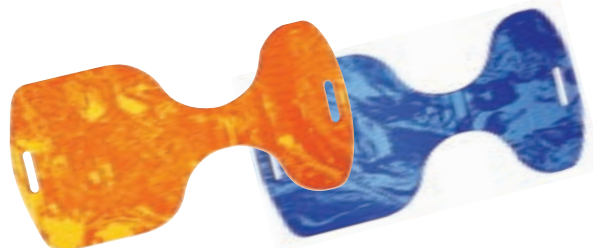

## AIRHEAD® SUNCOMFORT™ SADDLE

Stay cool on a hot day with SunComfort's super comfortable saddle float. You'll love the relaxing in-water immersion floating sensation. Nothing to inflate or assemble. The soft, luxurious EcoCell foam is more comfortable and durable than other materials. The convenient handle is great for carrying and hanging from a hook. 32" x 16" x 1 3/4".

PART #	MFG #	DESCRIPTION		
968121	AHSC-003	SUNCOMFORT Saddle, Blue Swirl	29.99	J
968122	AHSC-004	SUNCOMFORT Saddle, Orange Swirl	29.99	J

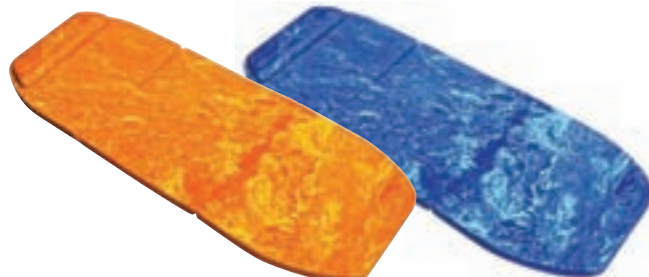

## AIRHEAD® SUNCOMFORT™ LOUNGE

Lay back and relax on AIRHEAD's comfy lounge in a pool, lake, or on the shore or poolside! The comfort that Suncomfort Lounge's unique tri fold design provides will blow you away! For pools, lakes, at the beach or poolside, you'll love the full body support and soft touch feel of the EcoCell foam. Stores in half the space of most lounges because it folds in three! 72" x 26" x 1 3/4"

PART #	MFG #	DESCRIPTION		
968123	AHSC-005	SUNCOMFORT Lounge, Blue Swirl	109.99	J
968124	AHSC-006	SUNCOMFORT Lounge, Orange Swirl	109.99	J



COMPACT  
FOLDABLE  
DESIGN!

- accessories
- towables
- body
- controls
- electrical
- driveline
- engine
- fuel & intake
- chemicals
- tie downs
- tools
- towing & loading

**AIRHEAD®  
BOATS**

**AIRHEAD**

**INFLATABLE BOATS**

AIRHEAD's inflatable boats are designed for fishing or good old fashioned family fun. They're lightweight, portable and ideal for lakes and slow moving streams. Constructed of heavy duty vinyl with electronically welded seams. Factory tested for quality assurance. Equipped with an Inflatable floor, wrap around tow rope, oar locks and oar holders. Repair kit included.

- 966176: 1 person, 60 in. x 40 in., 14 gauge, 9" Sponson
- 966177: 2 person, 76 in. x 46 in., 16 gauge, 11" Sponson
- 966178: 4 person, 110 in. x 60 in., 24 gauge, 12" Sponson



PART #	MFG #	U/M	DESCRIPTION		
966176	AHIB-1	EA	1 Person Inflatable Boat	31.99	J
966177	AHIB-2	EA	2 Person Inflatable Boat	44.99	J
966178	AHIB-4	EA	4 Person Inflatable Boat	99.99	J

**RECREATIONAL TRAVEL KAYAK**

- Designed for lakes and moderate white water
- Lightweight / compact / portable
- Semi-rigid heavy gauge PVC construction
- Tubular I-beam floor for superior comfort, buoyancy and tracking
- Spray covers fore and aft
- Movable / removable inflatable seats provide great back support
- 2 oversized valves for quick inflating and deflating.
- Drain hole with plug
- Paddles sold separately
- 2 man, 10 ft. 3 in., 2 seats



PART #	MFG #	U/M	DESCRIPTION		
966270	AHTK-5	EA	AIRHEAD ROATAN Inflatable Kayak	159.99	J

**BAJA KAYAK**

Don't let the reasonable price fool you, this is a serious piece of equipment! It's designed for paddling in ocean surf or on calm lake waters. The first thing you'll notice is how incredibly comfortable it is. You'll love the unique cockpit design, ergonomic backrest and recessed foot braces. Are you thirsty after all that paddling? No problem, there's an insulated recessed cooler in the rear that comfortably holds 6 drinks and ice. Put your paddle in the molded paddle holders while you relax with that cool drink! Stow your gear securely with the removable storage net up front. Carry handles are conveniently located fore and aft. Constructed of rugged K80 PVC, with a tracking fin and 2 patented Speed Safety Valves for quick and easy inflating and deflating. 110 x 41 in. (deflated). Paddle sold separately.



PART #	MFG #	U/M	DESCRIPTION		
966271	AHTK-6	EA	AIRHEAD BAJA Kayak	149.99	J

- accessories
- towables**
- body
- controls
- electrical
- driveline
- engine
- fuel & intake
- chemicals
- tie downs
- tools
- towing & loading

**MARINE**

- accessories
- towables
- body
- controls
- electrical
- driveline
- engine
- fuel & intake
- chemicals
- tie downs
- tools
- towing & loading



## AIRHEAD® BOATS



### ANGLER BAY 3 PERSON INFLATABLE BOAT

Angler Bay Inflatable Boats are designed to give you all the components you need to have a great fishing adventure. There are 2 rod holders, multiple molded drink holders, 4 drain plugs, a battery storage bag and a ditty bag. They're lightweight, portable and ideal for lakes and slow moving streams. Equipped with wrap-around grab lines, swiveling oar locks, transom mounting fixtures and side mounted oar holders. Constructed of heavy duty vinyl with electronically welded seams. Factory tested for quality assurance. Comfort features include an inflatable floor and a movable seat. Patented Speed Safety Valves for quick inflating and deflating. AHIBF-3: 3 person, 96 in. x 54 in., 24 gauge.

PART #	MFG #	U/M	DESCRIPTION		
966621	AHIBF-03	EA	AIRHEAD ANGLER BAY Inflatable Boat, 3 person	159.99	J

### ANGLER BAY 4 PERSON INFLATABLE BOAT

Angler Bay Inflatable Boats are designed to give you all the components you need to have a great fishing adventure. There are 2 rod holders, multiple molded drink holders, 4 drain plugs, a battery storage bag and a ditty bag. They're lightweight, portable and ideal for lakes and slow moving streams. Equipped with wrap-around grab lines, swiveling oar locks, transom mounting fixtures and side mounted oar holders. Constructed of heavy duty vinyl with electronically welded seams. Factory tested for quality assurance. Comfort features include an inflatable floor and a movable seat. Patented Speed Safety Valves for quick inflating and deflating. AHIBF-4: 4 person, 109 in. x 56 in., 30 gauge.



PART #	MFG #	U/M	DESCRIPTION		
966181	AHIBF-04	EA	AIRHEAD ANGLER BAY Inflatable Boat, 4 person	219.99	J

### ANGLER BAY 6 PERSON INFLATABLE BOAT

Angler Bay Inflatable Boats are designed to give you all the components you need to have a great fishing adventure. There are 2 rod holders, multiple molded drink holders, 4 drain plugs, a battery storage bag and a ditty bag. They're lightweight, portable and ideal for lakes and slow moving streams. Equipped with wrap-around grab lines, swiveling oar locks, transom mounting fixtures and side mounted oar holders. Constructed of heavy duty vinyl with electronically welded seams. Factory tested for quality assurance. Comfort features include an inflatable floor and a movable seat. Patented Speed Safety Valves for quick inflating and deflating. AHIBF-6: 6 person, 140 in. x 66.5 in., 32 gauge.



PART #	MFG #	U/M	DESCRIPTION		
966182	AHIBF-06	EA	AIRHEAD ANGLER BAY Inflatable Boat, 6 person	299.99	J

### 1 PADDLER PERFORMANCE TRAVEL KAYAK

Travel Kayak, Deluxe, 9 ft 9 in, 1 person

Inflatable kayaks are perfect for camping, vacationing, exploring remote areas, and for cruising yachts. They're also great for paddling enthusiasts that don't want to drive around with a kayak on their rooftop! AIRHEAD Travel Kayaks fit easily into the trunk of your car, duffel bag or suitcase. When you feel the itch to paddle, your boat is with you!

PART #	MFG #	U/M	DESCRIPTION		
966267	AHTK-1	EA	AIRHEAD MONTANA Kayak 1 person	449.99	J



### 2 PADDLER PERFORMANCE TRAVEL KAYAK

Travel Kayak, Deluxe, 12 ft, 2 person

Inflatable kayaks are perfect for camping, vacationing, exploring remote areas, and for cruising yachts. They're also great for paddling enthusiasts that don't want to drive around with a kayak on their rooftop! AIRHEAD Travel Kayaks fit easily into the trunk of your car, duffel bag or suitcase. When you feel the itch to paddle, your boat is with you!



PART #	MFG #	U/M	DESCRIPTION		
966268	AHTK-2	EA	AIRHEAD MONTANA Kayak 2 person	499.99	J



# AIRHEAD® SUP PADDLEBOARDS



**THE iSUP ADVANTAGE!** - Inflatable SUPs are so convenient, you'll PADDLE MORE! Exceptional Performance, No Sacrifice! Travel Worldwide with your iSUP! No expensive oversize luggage fees! Fits in Any Car, No Racks Required! Compact Storage in any Closet!

**ALL SUPs INCLUDE MESH BACKPACK, STAINLESS STEEL TOW RING, HI PRESSURE HAND PUMP, PRESSURE GAUGE, VALVE WRENCH, BOARD STRAP & REPAIR KIT**

## SUP CRUISE

CRUISE's "old school woody" styling begs for these boards to be taken on a cruise around the lake or yacht club. The 5 in. nose rocker and heavy duty 4 in. reinforced drop stitch construction with X-Cross Technology provide a quick, stable platform you can enjoy for years to come.

- 3 Classic Removable Fins, (2 x 6", 1 x 9")
- EVA Traction Pad
- 5 Stainless D-Rings, Stretch Tie Down
- EZ Push Hi Pressure Valve

### AHSUP-6, CRUISE 930 ISUP

- Board size: 9' x 30" x 4" (274 x 76 x 10 cm)
- Board weight: 21 lbs. (9.5 kg)
- For Paddlers 80 – 180 lbs. (36 – 82 kg)



PART #	MFG #	U/M	DESCRIPTION	
968133	AHSUP-6	EA	AIRHEAD SUP CRUISE 930 Paddleboard	949.00 J

### AHSUP-7, CRUISE 1030 ISUP

- Board size: 10'6" x 30" x 4" (320 x 76 x 10 cm)
- Board weight: 25 lbs. (11.4 kg)
- For Paddlers 100 – 210 lbs. (45 – 96 kg)



PART #	MFG #	U/M	DESCRIPTION	
968134	AHSUP-7	EA	AIRHEAD SUP CRUISE 1030 Paddleboard	1049.00 J

- accessories
- towables**
- body
- controls
- electrical
- driveline
- engine
- fuel & intake
- chemicals
- tie downs
- tools
- towing & loading

MARINE

# TOWABLES



## AIRHEAD® SUP PADDLEBOARDS

**THE iSUP ADVANTAGE!** - Inflatable SUPs are so convenient, you'll PADDLE MORE! Exceptional Performance, No Sacrifice! Travel Worldwide with your iSUP! No expensive oversize luggage fees! Fits in Any Car, No Racks Required! Compact Storage in any Closet!

**ALL SUPs INCLUDE MESH BACKPACK, STAINLESS STEEL TOW RING, HI PRESSURE HAND PUMP, PRESSURE GAUGE, VALVE WRENCH, BOARD STRAP & REPAIR KIT**

### SUP PACE

Set the PACE! These streamlined race boards glide through the water with paddling ease. The long tapered nose and slight tip rocker provides a fast nimble feel. These boards will have you leading the pack.

- Air-7 Box with 9" Race Removable Fin
- Extra Thick (4mm) EVA Traction Pad
- 5 Stainless D-Rings, Stretch Tie Down
- EZ Push Hi Pressure Valve

#### AHSUP-8, PACE 1030 ISUP

- Board size: 10'6" x 30" x 6" (320 x 76 x 15 cm)
- Board weight: 24 lbs. (10.9 kg)
- For Paddlers 100 – 240 lbs. (45 – 109 kg)



PART #	MFG #	U/M	DESCRIPTION	
968135	AHSUP-8	EA	AIRHEAD SUP PACE 1030 Paddleboard	1199.00 J



# MARINE

#### AHSUP-9, PACE 1230 ISUP

- Board size: 12'6" x 30" x 6" (381 x 76 x 15 cm)
- Board weight: 29 lbs. (13.2 kg)
- For Paddlers 120 – 300 lbs. (54 – 136 kg)



PART #	MFG #	U/M	DESCRIPTION	
968136	AHSUP-9	EA	AIRHEAD SUP PACE 1230 Paddleboard	1299.00 J



## AIRHEAD® SUP PADDLEBOARDS



**THE iSUP ADVANTAGE!** - Inflatable SUPs are so convenient, you'll PADDLE MORE! Exceptional Performance, No Sacrifice! Travel Worldwide with your iSUP! No expensive oversize luggage fees! Fits in Any Car, No Racks Required! Compact Storage in any Closet!

**ALL SUPs INCLUDE MESH BACKPACK, STAINLESS STEEL TOW RING, HI PRESSURE HAND PUMP, PRESSURE GAUGE, VALVE WRENCH, BOARD STRAP & REPAIR KIT**

### SUP BLISS

Comfortable full deck EVA pads and extra D-rings for adding SUP resistance training bands make these boards' versatile platforms for fitness and yoga. They're also great all-around paddleboards.

- One 9" Classic Removable Fin
- Extra Thick (4mm) EVA Traction Pad
- 9 Stainless D-Rings, Stretch Tie Down
- EZ Push Hi Pressure Valve

### AHSUP-10, BLISS 930 ISUP

- Board size: 9' x 30" x 4" (274 x 76 x 10 cm)
- Board weight: 20 lbs. (9.1 kg)
- Paddler weight: 80 – 180 lbs. (36 – 82 kg)



PART #	MFG #	U/M	DESCRIPTION		
968128	AHSUP-10	EA	AIRHEAD SUP BLISS 930 Paddleboard	999.00	J



### AHSUP-11, FIT 1032 ISUP

- Board size: 10'6" x 32" x 6" (320 x 81 x 15 cm)
- Board weight: 27 lbs. (12.3kg)
- For Paddlers 120 – 300 lbs. (54 – 136 kg)



PART #	MFG #	U/M	DESCRIPTION		
968129	AHSUP-11	EA	AIRHEAD SUP FIT 1032 Paddleboard	1179.00	J



### AHSUP-14, POPSICLE 730

This high quality iSUP looks like a popsicle! It's engineered to make paddling fun for lighter paddlers and kids. Rocker both front and rear provide smooth handling. POPSICLE is lightweight, so kids can carry their own board to the water!

- Board Size: 7' x 30" x 6" / 213 x 76 x 15 cm
- Board Weight: 19 lbs. / 8.6 kg
- For Paddlers 30 to 120 lbs. (14 - 55 kg)
- 4 Fixed Thruster Fins (nothing to lose), (2 x 3", 2 x 4 3/4")
- EVA Traction Pad with Tail Kicker
- EZ Push Hi Pressure Valve



PART #	MFG #	U/M			
968132	AHSUP-14	EA		779.00	J

- accessories
- towables**
- body
- controls
- electrical
- driveline
- engine
- fuel & intake
- chemicals
- tie downs
- tools
- towing & loading

# MARINE

# TOWABLES



## AIRHEAD® SUP PADDLEBOARDS

**THE iSUP ADVANTAGE!** - Inflatable SUPs are so convenient, you'll PADDLE MORE! Exceptional Performance, No Sacrifice! Travel Worldwide with your iSUP! No expensive oversize luggage fees! Fits in Any Car, No Racks Required! Compact Storage in any Closet!

**ALL SUPs INCLUDE MESH BACKPACK, STAINLESS STEEL TOW RING, HI PRESSURE HAND PUMP, PRESSURE GAUGE, VALVE WRENCH, BOARD STRAP & REPAIR KIT**

### SUP RAPIDZ

RAPIDZ amazing performance in whitewater is redefining the adventure SUP category! They are quick and agile and at the same time incredibly stable. RAPIDZ are so versatile, you'll love their performance in whitewater, on lakes, for fishing, hauling gear or just taking the dog for a sunset paddle.

- 3 Removable/Replaceable Fins, (2 x 6", 1 x 9")
- EZ Push Hi Pressure Valve

#### AHSUP-12, RAPIDZ 938 ISUP

- Board size: 9' x 38" x 6" (deck) / 7" (sponson)
- Board weight: 31lbs. (14 kg)
- Capacity: 260 lbs. (118 kg) Paddler & Gear
- Stainless D-Rings: 4 stainless D-Rings



**NEW PRODUCT**



PART #	MFG #	U/M	DESCRIPTION
968130	AHSUP-12	EA	AIRHEAD SUP RAPIDZ 938 Paddleboard



MARINE

#### AHSUP-13, RAPIDZ 1138 ISUP

- Board size: 11'6" x 38" x 4" (deck) / 6" (sponson)
- Board weight: 39lbs. (18 kg)
- Capacity: 330 lbs. (150 kg) Paddler & Gear
- Stainless D-Rings: 11 stainless D-Rings



**NEW PRODUCT**



PART #	MFG #	U/M	DESCRIPTION
968131	AHSUP-13	EA	AIRHEAD SUP RAPIDZ 1138 Paddleboard



**AIRHEAD®  
SS PADDLEBOARDS**



**SS STAND UP PADDLEBOARD**

SS stands for "Super Stable", and that's just what this very special inflatable SUP is. Beginners, intermediates and larger riders love the SS's unparalleled stability. Great for fishing, yoga & more! Experts, especially extreme whitewater paddlers, appreciate the stiffness, lower standing area, tapered rails and aggressive nose for punching through waves. SS remains stable even when way up on edge. Three fins, with removable center fin, ensure straight tracking. Dimensions inflated: 10' 8" x 38" x 6". A mesh backpack, high pressure hand pump, pressure gauge, valve wrench and repair kit are included.



PART #	MFG #	U/M	DESCRIPTION		
966671	AHSUP-2	EA	AIRHEAD SS Paddleboard	1199.00	G

A mesh backpack, high pressure hand pump, pressure gauge, valve wrench and repair kit are included.



PART #	MFG #	U/M	DESCRIPTION		
966693	AHSUP-3	EA	AIRHEAD SS Stand Up, Camo	1299.00	D

A mesh backpack, high pressure hand pump, pressure gauge, valve wrench and repair kit are included.



**TRANSOM FOR INFLATABLE BOATS  
MOTOR MOUNT**

This transom motor mount is designed for inflatable fishing boats including AIRHEAD ANGLER BAY boats. The stainless steel arms won't rust and are adjustable with a simple twist of the thumbscrews. The motor mount is crafted from marine grade hardwood. Motor and boat not included.

PART #	MFG #	U/M	DESCRIPTION		
966183	AHIBT-1	EA	AIRHEAD Transom Motor Mounts	69.99	G

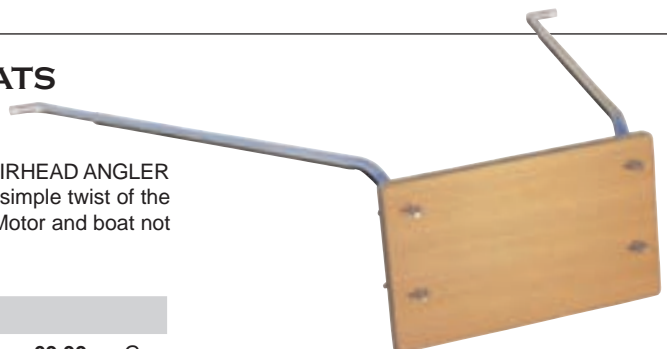

- accessories
- towables**
- body
- controls
- electrical
- driveline
- engine
- fuel & intake
- chemicals
- tie downs
- tools
- towing & loading

MARINE



**AIRHEAD®  
BOATS**

## NA PALI PADDLEBOARD

What's SUP? The Stand Up Paddleboard craze is sweeping the world. It's about time you joined in the fun! AIRHEAD's inflatable SUP measures 10 ft. 6 in. and is the best quality your money can buy. The extra rugged drop stitch construction allows a much higher air pressure than other inflatable technologies. Thousands of tiny threads connect the top and bottom layers. Consequently, it can hold 15 pounds of air pressure, more than double the working pressure of other technologies. When you're out on the water, Na Pali is rigid and will perform like a fiberglass board. A large anti-skid EVA pad provides secure footing. Strap your gear to the 4 D-rings up front. Three removable fins ensure straight tracking and precise maneuvering. Feel like sitting down? Install the seat in seconds and paddle kayak style. For convenience and portability, a backpack with mesh panels is included for stowing and carrying the SUP and all accessories. Accessories included: backpack w mesh panels, adjustable seat, high pressure hand pump, anemometer, valve wrench.



PART #	MFG #	DESCRIPTION		
966252	AHSUP-1	AIRHEAD NA PALI Paddleboard	999.00	J



AIRHEAD  
Adjustable SUP Paddle sold separately  
(part #966253)



## OCHO RIOS PADDLEBOARD

PART #	MFG #	DESCRIPTION		
968078	55-1030	SPORTSSTUFF OCHO RIOS Paddleboard	779.99	J
968079	55-1040	SPORTSSTUFF OCHO RIOS Paddleboard includes an Adjustable Aluminum Paddle with a Fiberglass Reinforced Blade	819.99	J



968078

A terrific value, Ocho Rios is a high pressure inflatable paddleboard that's lightweight and fast. It feels very similar to a hard board (can be inflated to 15 psi) and supports paddlers up to 220 lbs. Large EVA traction pad. Stainless tow ring and leash ring. 1 detachable tracking fin. High grade materials and workmanship for years of enjoyment. Includes Carry Bag, Pump, Gauge and Repair Kit. A great all around paddleboard.

- Dimensions: 10' 6" x 30" x 4" (320 x 76 x 10 cm) / 25 lbs. (11.4 kg).
- EZ Push Hi Pressure Valve
- Includes Mesh Backpack, Stainless Steel Tow Ring, Hi Pressure Hand Pump, Pressure Gauge, Valve Wrench, Board Strap & Repair Kit



968079

AIRHEAD®  
BOATS

**AIRHEAD**



**AIRHEAD BOB**

What about BOB? BOB is an advanced 4 rider tow rope with inflatable buoy in the middle that will boost your towable's performance to a whole new level. It keeps the rope out of the water while towing which reduces drag, rope spray, and submarining. This 60 foot long advanced towing system (including ball) has a 4,100 pound break strength. BOB features a heavy-duty full nylon cover, self bailing drain vent, and patented Speed Safety Valve for fast and easy inflation and deflation.

PART #	MFG #	U/M	DESCRIPTION		
966678	AHBOB-1	EA	AIRHEAD BOB	125.99	J



**NEW  
PRODUCT**

**AIRHEAD ORB**

Are you frustrated that your tube rope is stuck in the wake all the time? AIRHEAD ORB keeps your tube tow rope out of the water and the wake so the tube responds instantly to the boat's change of direction, as it's meant to do. ORB is an absolute necessity to effectively tow tubes from a boat with a low tow point on the transom. It enhances safety and extends the tube's life because it virtually eliminates all slack in the line. A 60 foot, 4100 lb. tensile strength rope is included. Durable 30 gauge PVC construction (no nylon cover)

PART #	MFG #	U/M	DESCRIPTION		
968114	AHOR-1	EA	AIRHEAD ORB	64.99	J

accessories

towables

body

controls

electrical

driveline

engine

fuel & intake

chemicals

tie downs

tools

towing & loading

MARINE



- accessories
- towables
- body
- controls
- electrical
- driveline
- engine
- fuel & intake
- chemicals
- tie downs
- tools
- towing & loading



## ANCHOR BUNGEE

Stretches from 14' to 50' for Boats

Anchor Bungee enables you to tether your boat offshore, away from a beach or rocky shoreline without having to swim or use a dinghy! Connect an anchor to your boat with the high tensile strength Anchor Bungee and set the anchor offshore. A heavy duty zinc plated shackle and snap hook are provided for attaching the Anchor Bungee to your anchor and boat. Tie a line to the stern to pull the boat into the shore to unload your group. Simply secure the end of the rope to a stake onshore and release the rope; Anchor Bungee will pull the boat away from shore into safe waters! Anchor Bungee flexes to relieve stress on the anchor, increasing its holding power. The bright red and yellow 16 strand 2500 lb. tensile strength rope is easy to spot and is constructed of polypropylene so it floats. Use it once and you'll wonder how you ever lived without one!



## ANCHOR BUNGEE LITE

Stretches from 7' to 22' for PWC's

PART #	MFG #	U/M	DESCRIPTION		
966674	AHAB-1	EA	AIRHEAD Anchor Bungee	37.99	J
966675	AHAB-2	EA	AIRHEAD Anchor Bungee Lite	25.99	J

## TUBE ANCHOR™

Turn your towable into a portable swim platform with AIRHEAD's Tube Anchor. While the kids are lounging or playing on the tube, adults get to enjoy a little quiet time on the boat, dock or beach! AIRHEAD's Tube Anchor bag is constructed of durable reinforced PVC/polyester tri-laminate. Simply fill it with rocks or sand and drop it into the water. The buoy has a convenient mesh compartment inside for stowing slack from the 20 foot long rope. A giant acetyl snap hook allows for easy hook ups to your tube's handle or tow strap.



PART #	MFG #	U/M	DESCRIPTION		
966141	AHAT-1	EA	AIRHEAD Tube Anchor	17.99	J

## SUP PADDLE CARBON FIBER COMPOSITE

- Lightest weight
- One-size-fits-all
- Length adjusts from 63" to 83" (160 to 210 cm)
- Stiff lightweight carbon fiber composite shaft
- Fiberglass reinforced polymer "duck foot" blade
- Carbon Handle
- 3-section, easy to stow



**NEW PRODUCT**



PART #	MFG #	U/M	DESCRIPTION		
968150	AHSUP-P4	EA	AIRHEAD SUP PADDLE 3 Section - Carbon Comp	159.99	J

## YOUTH SUP PADDLE ALUMINIUM

- One-size-fits-all
- Length adjusts from 52" to 74" 132 to 188 cm perfect for paddlers 43" to 65" tall.
- 100% aluminium shaft
- Fiberglass reinforced ABS "duckfoot" blade
- 3-section, easy to stow



**NEW PRODUCT**



PART #	MFG #	U/M	DESCRIPTION		
968151	AHSUP-P5	EA	AIRHEAD SUP PADDLE 3 Section - Aluminum	39.99	J

## SUP SOFT EDGE PADDLE CARBON FIBER COMPOSITE

- Lightest weight - One-size-fits-all
- Length adjusts from 63" to 83" (160 to 210 cm)
- Stiff lightweight carbon fiber composite shaft
- Fiberglass reinforced ABS "duckfoot" blade with soft TPE edge that prevents damage to fiberglass boards
- Carbon Handle
- 3-section, easy to stow



**NEW PRODUCT**



PART #	MFG #	U/M	DESCRIPTION		
968152	AHSUP-P6	EA	AIRHEAD SUP PADDLE 3 Section - Carbon Fiber	119.99	J



**AIRHEAD®  
BOATS**



**KAYAK PADDLE**

A good portable kayak paddle at a great price. The 3-section aluminum and plastic paddle is 86 inches long. Break it down for compact storage (stows in a 6" x 22" x 3" space).



PART #	MFG #	U/M	DESCRIPTION		
966272	AHTK-P1	EA	AIRHEAD KAYAK PADDLE, 3 section, aluminum	23.99	J



**PERFORMANCE  
KAYAK PADDLE**

This 7 foot long kayak paddle breaks down into 2 sections for convenient stowing. You can easily adjust the blade angle for standard or offset paddling. The lightweight and durable aluminum shaft has drip rings and foam hand grips for comfort and to ensure that the paddle will float if dropped. The large ABS blades are curved for greater paddling efficiency.

PART #	MFG #	U/M	DESCRIPTION		
966273	AHTK-P2	EA	AIRHEAD KAYAK PADDLE, deluxe 2 section	39.99	J

**KAYAK PADDLE**

AIRHEAD's 86 inch kayak paddle breaks down into 4 sections for compact storage. The blades are asymmetrical to equalize the force on both sides of the blade when paddling, which in turn results in less twisting of the paddle. The high impact plastic blades are lightweight and reinforced with fiberglass for added durability. Blade angles are adjustable with a simple release of the spring loaded pin and a twist of the lightweight anodized aluminum shaft.



PART #	MFG #	U/M	DESCRIPTION		
966274	AHTK-P3	EA	AIRHEAD KAYAK PADDLE, 4 section, 220cm	41.99	J



**SUP PADDLE**

AIRHEAD's lightweight 3-section SUP paddle is the perfect companion to our Na Pali stand up paddleboard (part #966252). This is truly a one-size-fits-all paddle. The length is easily adjustable from 160 to 210 cm.. The paddle weighs less than 2 lbs. 3 oz. (992 gm). The shaft is 100% fiberglass, the "duck foot" shape blade is designed for maximum paddling efficiency and is fiberglass reinforced ABS.

PART #	MFG #	U/M	DESCRIPTION		
966253	AHSUP-P1	EA	AIRHEAD STAND UP PADDLEBOARD PADDLE	109.99	J

**2 IN 1 SUP /  
KAYAK PADDLE**

This 3-section SUP / KAYAK paddle is an amazing dual performance paddle for your AIRHEAD Na Pali or other stand up paddleboard. Explore uncharted waters with the SUP Handle or connect the included Kayak Paddle section for a seated kayak style ride. The SUP handle length can easily be adjusted from 165 cm to 185 cm and the Kayak Paddle adjusts from 208 cm to 228 cm. The aluminum shafts and High Impact Plastic Blades are specifically designed for both SUPs and kayaks.



PART #	MFG #	U/M	DESCRIPTION		
966696	AHSUP-P3	EA	AIRHEAD 2 IN 1 SUP / KAYAK PADDLE	59.99	J



- accessories
- towables**
- body
- controls
- electrical
- driveline
- engine
- fuel & intake
- chemicals
- tie downs
- tools
- towing & loading

MARINE



### TELESCOPING PADDLE

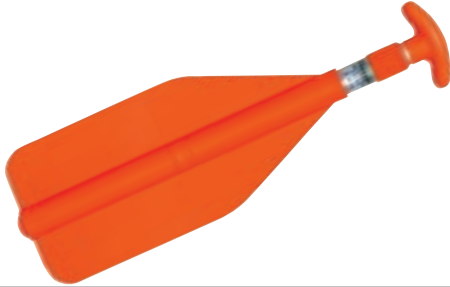

These lightweight paddles adjust easily to variable lengths with a simple twist. A section of the aluminum shaft disappears inside the blade to allow for compact storage under boat seats or in PWC storage compartments. The corrosion-resistant aluminum shaft, high-impact molded blade and boat hook handle, and hassle-free locking device ensure years of service. The bright orange blade is great for signaling in emergencies.

PART #	MFG #	U/M	DESCRIPTION		
966506	P-1	EA	TELESCOPING PADDLE, 20"- 42"	17.99	J

### TELESCOPING PADDLE WITH NYLON BAG

These lightweight paddles adjust easily to variable lengths with a simple twist. A section of the aluminum shaft disappears inside the blade to allow for compact storage under boat seats or in PWC storage compartments. The corrosion-resistant aluminum shaft, high-impact molded blade and boat hook handle, and hassle-free locking device ensure years of service. The bright orange blade is great for signaling in emergencies.



PART #	MFG #	U/M	DESCRIPTION		
966507	P-2	EA	TELESCOPING PADDLE w/Nylon Bag	22.99	J



### TELESCOPING PADDLE WITH BOAT HOOK



These lightweight paddles adjust easily to variable lengths with a simple twist. A section of the aluminum shaft disappears inside the blade to allow for compact storage under boat seats or in PWC storage compartments. The corrosion-resistant aluminum shaft, high-impact molded blade and boat hook handle, and hassle-free locking device ensure years of service. The bright orange blade is great for signaling in emergencies.

PART #	MFG #	U/M	DESCRIPTION		
966508	P-3	EA	TELESCOPING PADDLE w/Boat Hook, 24"- 72"	22.99	J



### OARS

These inexpensive oars are designed for use with AIRHEAD and other inflatable boats. The 2 section aluminum shafts are durable and lightweight. The 15 in. high impact plastic blades and grips are designed for maximum rowing efficiency and comfort. Length: 53 in., 1 pair per package.

PART #	MFG #	U/M	DESCRIPTION		
966179	AHIB-53	PR	AIRHEAD Oars, 53", White, 1 pair	25.99	J



- accessories
- towables
- body
- controls
- electrical
- driveline
- engine
- fuel & intake
- chemicals
- tie downs
- tools
- towing & loading

## AIRHEAD® ROPES



### TOW DEMON™

AIRHEAD's TOW DEMONS are new higher strength versions of a classic and very popular water sports tow harness. The high-impact molded plastic float / pulley system allows for easy attachment of ski ropes, wakeboard ropes and tube ropes. Connect TOW DEMON quickly and easily to boats with the 2 large corrosion-resistant snap hooks. Available in vinyl-jacketed steel cable and floating rope versions. Recommended for recreational water skiing, wakeboarding, kneeboarding and towing 1 rider tubes. Snap hook opening width 7/16".



PART #	MFG #	U/M	DESCRIPTION		
966261	AHTH-4	EA	AIRHEAD TOW DEMON Harness, 8' rope	16.99	J
966262	AHTH-5	EA	AIRHEAD TOW DEMON Harness, 12' rope	17.99	J
966263	AHTH-6	EA	AIRHEAD TOW DEMON Harness, 8' cable	20.99	J
966264	AHTH-7	EA	AIRHEAD TOW DEMON Harness, 12' cable	23.99	J

### TUBE KEEPER™

Secure Towables to Your Boat for Safety! Tired of lying on top of your tubes to keep them from flying out of your boat? No place to sit? Tube Keeper to the rescue! It saves essential passenger space and prevents serious injuries by securing towables to your boat's stern. Simply attach the straps around the tube's handles. Then attach with either the giant 3-1/4 in. suction cups or loop the stretch cords around a cleat or rail. The 2" wide adjustable straps are easy to tighten for a secure hold.



PART #	MFG #	U/M	DESCRIPTION		
966536	TB-101	EA	AIRHEAD TUBE KEEPER	16.99	J

### KWIK-CONNECT™

Conveniently attach and detach tube tow ropes to towables with AIRHEAD's Kwik-Connect. There's no need to thread 60 feet of rope through the tow strap each time you connect or disconnect a tow rope. The high impact Kwik-Connect has a 1 inch diameter hole to accept up to 6,000 lb. break strength tube ropes. Recommended for 1 to 4 rider towables that are not equipped with Kwik-Connects.



PART #	MFG #	U/M	DESCRIPTION		
966186	AHKC-1	EA	AIRHEAD KWIK-CONNECT	9.99	J

### LINE WINDER

No more tangled lines with this classic styled floating line winder! It's easy to wind and neatly stow away anchor lines, mooring lines, ski ropes and tube ropes. Get a few for the garage too. Organize your extension cords, wires, clotheslines and Christmas lights once and for all. It's constructed of high impact polypropylene for extra long service. Holds up to 150 feet of 3/8" diameter rope. Color: Red. Rope not included.



PART #	MFG #	U/M	DESCRIPTION		
966187	AHLW-1	EA	AIRHEAD LINE WINDER	7.99	J

### BUNGEE TUBE ROPE EXTENSION

Add extra zing, excitement and comfort to your tubing! Attach AIRHEAD's Bungee Tube Rope Extension between your boat's tow point and the tube tow rope. You'll enjoy brief surges of speed as the bungee stretches and contracts. It reduces wear and tear on tubes and riders too, by absorbing sudden jerks from slack in the line. This 16 strand, 9/16 inch x 3 foot polypropylene rope stretches to 5 feet. The 4,150 pound tensile strength is perfect for up to 4 rider tubes. Red & Yellow.



PART #	MFG #	U/M	DESCRIPTION		
966698	AHTRB-3	EA	AIRHEAD BUNGEE TUBE ROPE EXTENSION	14.99	J

- accessories
- towables
- body
- controls
- electrical
- driveline
- engine
- fuel & intake
- chemicals
- tie downs
- tools
- towing & loading

MARINE



## AIRHEAD® ROPES

- accessories
- towables**
- body
- controls
- electrical
- driveline
- engine
- fuel & intake
- chemicals
- tie downs
- tools
- towing & loading



### TOW HARNESS - 1 RIDER

If your boat isn't equipped with a pylon or ski eye and you enjoy watersports activities, you need a tow harness. It creates a tow attachment point at the center of your boat, behind your outboard or stern drive. This tow harness is perfect for pulling a skier, wake boarder, knee boarder or 1 rider tubes. Simply clip it onto your boat with the hooks provided, and attach your ski or tube rope. A 6" float keeps the attachment loop floating on top, away from your propeller. 12 feet long to fit larger boats and pontoons. Yellow / Red.

PART #	MFG #	U/M	DESCRIPTION		
966258	AHTH-1	EA	AIRHEAD TOW HARNESS, 12 ft.	11.99	G

### SELF CENTERING TOW HARNESS

We combined the popular self-centering feature of our top selling rope tow harness with a durable cable. Heavy duty 5,000 lb. hooks connect the tow harness to your boat. The extra long 14 ft. cable fits most larger boats. As the stainless steel pulley glides along the cable, it keeps the tow point centered for the optimum pull at all times. Tow rope hook-ups are easy with the heavy duty Kwik-Connect. Designed for water skiing, wakeboarding, kneeboarding and 1 or 2 rider towables. 3,000 lb. tensile strength.



PART #	MFG #	U/M	DESCRIPTION		
966266	AHTH-9	EA	AIRHEAD SELF CENTERING TOW HARNESS, 14 ft Cable	37.99	J



### SELF CENTERING TOW HARNESS - 2 RIDERS

This 3,000-pound tensile strength tow harness is perfect for pulling skiers, wake boarders and up to 2 rider towables. A stainless steel pulley glides along the length of the rope to provide the optimum pull at all times. Simply clip it onto your boat with the 5,000-pound tensile strength hooks provided, and attach your ski or tube rope to the heavy duty Kwik-Connect. The 6" float ensures that the Kwik-Connect floats, away from your propeller. It's 12 feet long to fit pontoon and larger boats. Yellow / Black.

PART #	MFG #	U/M	DESCRIPTION		
966260	AHTH-3	EA	AIRHEAD TOW HARNESS, Self Centering Pulley, 12 ft.	29.99	J

### TOW HARNESS - 4 RIDERS

This heavy duty tow harness is perfect for pulling skiers, wake boarders and up to 4 rider towables. Simply clip it onto your boat with the 5,000-pound tensile strength hooks, and attach your ski or tube rope to the heavy duty Kwik-Connect. A 6" float keeps the Kwik-Connect floating on top, away from your propeller. 12 feet long to fit larger boats and pontoons. Yellow / Red.

PART #	MFG #	U/M	DESCRIPTION		
966259	AHTH-2	EA	AIRHEAD HEAVY DUTY TOW HARNESS	21.99	J



### HEAVY DUTY TOW HARNESS

This watersports tow harness is equipped with oversized extra heavy duty hooks. They're perfect for hooking up to troublesome pontoon tow points. It's extra long, 16 feet, to stretch across wide beams. Engineered to tow skiers, wake boarders and up to 4 rider towables, simply clip it onto your stern eyes and attach your ski or tube rope to the heavy duty Kwik-Connect. The 6" float ensures that the Kwik-Connect floats, away from your propeller. Yellow / Black.



PART #	MFG #	U/M	DESCRIPTION		
966265	AHTH-8HD	EA	AIRHEAD HD TOW HARNESS, 16 ft.	32.99	J

## AIRHEAD® ROPES



### BLING TUBE ROPES

These ropes will give you swagger! AIRHEAD's BLING Series ropes add another dimension to towing, as they sparkle in the sun and glow in twilight! The extravagant look compliments the luxury of high end boats, adds a little class to lesser boats and makes you look like a watersports pro! BLING series ropes are one of a kind, shiny and reflective material is braided together with top quality polypropylene. These tube tow ropes are 60 ft. long with a loop at each end. A "totally blinged-out" rope keeper is included.

966276: 2,375 lb. Tensile Strength, for up to 2 Rider Towables

966277: 4,100 lb. Tensile Strength, for up to 4 Rider Towables

966278: 6,000 lb. Tensile Strength, for up to 6 Rider Towables

PART #	MFG #	U/M	DESCRIPTION		
966276	AHTR-12BL	EA	AIRHEAD BLING 2 Rider Tube Rope	23.99	J
966277	AHTR-14BL	EA	AIRHEAD BLING 4 Rider Tube Rope	31.99	J
966278	AHTR-16BL	EA	AIRHEAD BLING 6 Rider Tube Rope	41.99	J



### DYNEEMA THERMAL WAKEBOARD ROPE

AIRHEAD's Dyneema Thermal wakeboard rope provides zero stretch for the crisp instantaneous response that expert wakeboard riders demand. The Thermal-coated Dyneema line is stiff and rigid, resists kinking and twisting, floats and boasts a 2,000 lb. break strength. It's 70 foot long with a 5 foot handle bridle and 4 section mainline (5,50,5,5,5). Equipped with 15 inch wide EVA grip and full length PVC tubing for added durability. A Rope Keeper is included for tangle-free storage

PART #	MFG #	U/M	DESCRIPTION		
968153	AHWR-7	EA	AIRHEAD WAKEBOARD ROPE - Electric Blue	99.99	J
968154	AHWR-8	EA	AIRHEAD WAKEBOARD ROPE - Electric Red	99.99	J



### 1 RIDER TUBE TOW ROPE

This tube tow rope has a 1,500-pound tensile strength, meeting WSIA recommendations for 1-rider towables. It's 50 feet long with a 6" loop at each end. A Rope Keeper is included. Color: Yellow. A good tube rope at a great price.

PART #	MFG #	U/M	DESCRIPTION		
966282	AHTR-50	EA	TUBE TOW ROPE, 1 rider, 50'	12.99	J

### 2 RIDER TUBE TOW ROPE

This 3/8" 16-strand braided tow rope is rated at 2,375 pounds tensile strength. There's a 6" loop spliced at each end. A Rope Keeper is included for tangle-free storage. Designed for 1 and 2 rider tubes.

PART #	MFG #	U/M	DESCRIPTION		
966283	AHTR-60	EA	TUBE TOW ROPE, 2 rider	16.99	J



### BUNGEE TUBE TOW ROPE

Add a little extra zing and excitement to your tubing! This 9/16" x 50 ft. tube rope has a 3/8" diameter bungee cord spliced inside. It's rated at 4,150 pounds tensile strength, conforming to WSIA recommendations for 1 - 4 rider tubes. You'll enjoy brief surges of speed as the bungee stretches and contracts. It reduces wear and tear on tubes and riders too, by absorbing sudden jerks from slack in the line. A Rope Keeper is included for convenient storage.

PART #	MFG #	U/M	DESCRIPTION		
966285	AHTRB-50	EA	AIRHEAD BUNGEE TUBE TOW ROPE, 50 ft.	41.99	J

- accessories
- towables
- body
- controls
- electrical
- driveline
- engine
- fuel & intake
- chemicals
- tie downs
- tools
- towing & loading

MARINE



## AIRHEAD® ROPES

- accessories
- towables
- body
- controls
- electrical
- driveline
- engine
- fuel & intake
- chemicals
- tie downs
- tools
- towing & loading



### 2 RIDER, 2 SECTION TUBE ROPE

This tube tow rope has 2 sections, giving you the option to tow the tube either 50 or 60 feet behind the boat depending on wake and water conditions. The pre-stretched UV-resistant 7/16 inch diameter 16-strand rope exceeds the 2,375 pound break strength required by the WSIA for 2-rider tubes. A Rope Keeper is included for convenient storage.

PART #	MFG #	U/M	DESCRIPTION		
966279	AHTR-22	EA	AIRHEAD 2 RIDER TUBE ROPE, 2 Section, Float	17.99	J

### 3 RIDER TUBE ROPE

This heavy-duty 1/2 inch x 60 foot, 16 strand tube tow rope is engineered to pull 1 to 3 rider tubes effortlessly. This high quality polypropylene rope floats and will stand the test of time. It's rated at 3,350 pounds tensile strength. You'll love the eye catching bright blue and black color scheme. There's a 6-inch loop spliced at each end. A Rope Keeper is included for tangle-free storage.

PART #	MFG #	U/M	DESCRIPTION		
966697	AHTR-30	EA	AIRHEAD 3 RIDER TUBE ROPE	19.99	J



### 4 RIDER TUBE ROPE

This tube tow rope has 2 sections, giving you the option to be either 50 or 60 feet behind the boat depending on wake and water conditions. The pre-stretched UV-resistant 5/8 inch diameter 16-strand rope exceeds the 4,150 pound break strength required by the WSIA for 4 rider tubes. A Rope Keeper is included for convenient storage.

PART #	MFG #	U/M	DESCRIPTION		
966281	AHTR-42	EA	AIRHEAD 4 RIDER TUBE ROPE	24.99	J

### 4 RIDER TUBE ROPE

This heavy-duty 16 strand 9/16 inch x 60 foot tube tow rope is rated at 4,150 pounds tensile strength! Engineered to pull the big 3 and 4 rider tubes, this rope will stand the test of time. It has a unique Rasta color scheme with a 6-inch loop spliced at each end. A Rope Keeper is included for tangle-free storage.

PART #	MFG #	U/M	DESCRIPTION		
966280	AHTR-4000	EA	AIRHEAD 4 RIDER TUBE ROPE	23.99	J



### SUPER STRENGTH 6 RIDER TUBE ROPE

This super strength 16 strand, 7/8 inch x 60 foot tube tow rope is rated at 6,000 pounds tensile strength! It's the strongest tube rope your money can buy, and is engineered to pull 5 riders. The "killer bee" color scheme is easy to spot in any water conditions. A Rope Keeper is included for tangle-free storage. Great for towing boats too!

PART #	MFG #	U/M	DESCRIPTION		
966284	AHTR-6000	EA	TUBE TOW ROPE, 6000 lb.	31.99	J

**AIRHEAD®  
ROPES**



- accessories
- towables**
- body
- controls
- electrical
- driveline
- engine
- fuel & intake
- chemicals
- tie downs
- tools
- towing & loading

**WATER SKI ROPE**

This 1 section ski rope has an aluminum floating handle and molded end caps for safety and comfort. The 16-strand 75 foot long rope is UV-treated and pre-stretched. A Rope Keeper is included.

PART #	MFG #	U/M	DESCRIPTION		
966235	AHSR-1	EA	AIRHEAD Ski Rope	18.99	J



**WATER SKI ROPE**

This 1 section ski rope has an aluminum floating handle and molded end caps for safety and comfort. The 12 in. EVA grip provides a great handhold. The 16-strand 75 foot long rope is UV-treated and pre-stretched. A Rope Keeper is included.

PART #	MFG #	U/M	DESCRIPTION		
966236	AHSR-1EVA	EA	AIRHEAD Ski Rope, 1 Section, EVA Handle	19.99	J

**PERFORMANCE RADIUS HANDLE SKI ROPE**

Ski longer, harder and stronger with less muscle fatigue. The 17 degree, 13 inch radius aluminum core handle offers a more natural grip. Eye-catching "amoeba" patterned EVA wraps the handle and provides a great grip. The 3/8 inch, 16 strand, UV treated mainline has 3 sections for skiing, wakeboarding or kneeboarding at 75, 60 or 45 feet. Full length finger guards help create a comfortable split finger grip. The encased crossover yoke protects the rope from high abrasion wear areas. A Rope Keeper is included for tangle free storage.

PART #	MFG #	U/M	DESCRIPTION		
966238	AHSR-3	EA	AIRHEAD RADIUS HANDLE SKI ROPE	33.99	J



**4 SECTION WATER SKI ROPE**

This 75 foot long rope has 4 sections (40ft., 10ft., 10ft., 15ft.) to meet the needs of skiers and riders of all skill levels. The 12" aluminum core handle has a performance "Tractor" grip and full-length molded finger protectors. You'll love the candy stripe color scheme of the UV-treated 16-strand 1,600 lb. tensile strength rope. A Rope Keeper is included for tangle-free storage.

PART #	MFG #	U/M	DESCRIPTION		
966239	AHSR-4	EA	AIRHEAD SKI ROPE, 4-section	31.99	J



**1 SECTION WATER SKI ROPE**

Engineered to provide superior quality and strength at an unbeatable price, this 5/16 in. x 75 ft. 16 strand ski rope delivers 1500 pound break strength. The 12 inch floating handle has an aluminum core and a textured TPR grip that lessens fatigue for the grasping hand. Four inch end caps protect your fingers and help create a comfortable split finger grip. A Rope Keeper is included for tangle free storage.

PART #	MFG #	U/M	DESCRIPTION		
966240	AHSR-5	EA	AIRHEAD SKI ROPE, 1 Section	21.99	J



MARINE



- accessories
- towables
- body
- controls
- electrical
- driveline
- engine
- fuel & intake
- chemicals
- tie downs
- tools
- towing & loading



### 75' 1 SECTION SKI ROPE

A high quality 1 section ski rope for skiing, wakeboarding and kneeboarding. The 12" aluminum core handle has a performance "Tractor" grip and molded finger protectors. You'll love the blue and white candy stripe color scheme of the UV-treated 16-strand rope. A Rope Keeper is included for tangle-free storage.

PART #	MFG #	U/M	DESCRIPTION		
966242	AHSR-75	EA	AIRHEAD SKI ROPE, 1 section	24.99	J

### 8 SECTION RADIUS HANDLE SKI ROPE

Ski longer, harder and stronger with less muscle fatigue. The 17 degree, 13 inch radius aluminum core handle with TPR Diamond Grip is the ultimate in quality. There are 8 color-coded sections and take-up loops for skiing in slalom courses or for finding just the right spot to ski on your boat's wake. Full length finger guards help create a comfortable split finger grip. You'll love the candy stripe color scheme of this UV-treated, 3/8 inch, 16-strand, 1,600 lb. tensile strength rope. A Rope Keeper is included for tangle-free storage.

PART #	MFG #	U/M	DESCRIPTION		
966243	AHSR-8	EA	AIRHEAD SKI ROPE, 8-section	34.99	J



### DOUBLE HANDLE SKI ROPE

Double handle ski ropes have been popular for learning how to slalom for decades. Some experienced skiers also enjoy a double handle pull. This is the highest quality double handle ski rope ever made. The TPR tractor grip and 4" finger guards provide a comfortable and precise hold. You can't miss the rope during deep water starts with this bright yellow and red color scheme. 75 feet long, 1 section.

PART #	MFG #	U/M	DESCRIPTION		
966241	AHSR-6	EA	AIRHEAD DOUBLE HANDLE SKI ROPE	29.99	J

### WATERSPORTS ROPE

This eye catching watersports rope is a great choice for a wide range of activities, including skiing, wakeboarding, wakeskating and kneeboarding. The 12 inch aluminum core handle is wrapped with textured high density EVA for a great grip. The 75 foot long 16-strand rope and handle float and are brightly colored for your easy retrieval. A Rope Keeper is included for convenient storage.

PART #	MFG #	U/M	DESCRIPTION		
966244	AHSR-9	EA	AIRHEAD WATERSPORTS ROPE, EVA Handle	29.99	J





**AIRHEAD®  
ROPES**



**EZ UP SLALOM TRAINING ROPE**

A perfect rope for learning deep water ski starts, it has a Deep V - EZ Up bridle to steady the ski and to keep it pointing straight ahead. As the skier comes out of the water, the rope automatically rises off the ski. The 12 inch floating handle has a textured TPR grip, aluminum core and molded end caps and finger guards. The 75 foot long, 16-strand rope is UV-treated and has a 1500 lb. tensile strength. For added durability, the EZ Up bridle is completely covered with flexible vinyl. A Rope Keeper is included for tangle-free storage.

PART #	MFG #	U/M	DESCRIPTION		
966237	AHSR-2	EA	AIRHEAD SKI ROPE, Deep V	31.99	J

**WAKESURF ROPE SPIRAL BRAID  
16 FT.**

PolyE wakesurf rope has a 3 section mainline, a 12 inch grasp knot and a extra large spiral rope braid. You'll have an easy time finding the sweet spot of the boat's wake with this rope design. Blue/Black to match AIRHEAD BONZAI Wakesurfer. Break strength: 1200 lb.



PART #	MFG #	U/M	DESCRIPTION		
966702	AHWS-R01	EA	AIRHEAD WAKESURF ROPE - 16 ft.	29.99	J



**WAKEBOARD ROPE WITH EVA GRIP HANDLE**

This wakeboard rope has a head turning 15 in. Squid patterned EVA-wrapped grip with a floating aluminum core. The 5/16 inch, 16 strand, UV treated low stretch rope has 3 sections for wakeboarding at 45, 55 or 65 feet (45, 10, 10). Full length finger guards help create a comfortable split finger grip. A Rope Keeper is included for tangle free storage.

PART #	MFG #	U/M	DESCRIPTION		
966373	AHWR-3	EA	WAKEBOARD ROPE, 15" EVA Handle, 3 section	31.99	J

**DYNA-CORE WAKEBOARD ROPE**

An AIRHEAD exclusive, this wakeboard rope has the small diameter look of Spectra or Dyneema, the ultra low stretch too, but at half the price! Only a professional can notice the difference. The 70 foot wakeboard rope has 3 take-offs in the mainline and a 5 foot handle bridle (5, 50, 5, 5, 5). The 15 inch wide EVA grip is eye catching, provides a great grip. A Rope Keeper is included for tangle-free storage. Red.



PART #	MFG #	U/M	DESCRIPTION		
966376	AHWR-6	EA	AIRHEAD Dyna Core Wakeboard Rope	42.99	J



**SPECTRA FUSION WAKEBOARD ROPE**

All wakeboarders can benefit from a professional grade no-stretch rope. AIRHEAD's carbon fiber look Spectra Fusion wakeboard rope provides the crisp response that expert wakeboard riders demand and all wakeboarders benefit from. A braided poly-E Fusion jacket protects the Spectra core. The line is stiff and rigid, resists kinking and twisting, floats and has a 2,000 lb. break strength. The 70 foot wakeboard rope has 3 take-offs in the mainline and a 5 foot handle bridle (5,50,5,5,5). The 15 inch wide EVA grip is eye catching and provides a great grip. A Rope Keeper is included for tangle-free storage.

PART #	MFG #	U/M	DESCRIPTION		
966375	AHWR-5	EA	AIRHEAD Spectra Fusion Wakeboard Rope	79.99	J

- accessories
- towables**
- body
- controls
- electrical
- driveline
- engine
- fuel & intake
- chemicals
- tie downs
- tools
- towing & loading

MARINE

## AIRHEAD

## AIRHEAD® ROPES

- accessories
- towables
- body
- controls
- electrical
- driveline
- engine
- fuel & intake
- chemicals
- tie downs
- tools
- towing & loading



### WAKEBOARD ROPE WITH PHAT GRIP™

This low stretch rope provides professional wakeboard rope quality at half the price. The 15" double-density EVA PHAT GRIP handle is machined to provide a superior grip for optimum performance. It has a high strength aluminum core, 4" finger protectors and foam floats. The 6" TPR covered aluminum handle provides extra leverage and pull for spins and inverted tricks. The bridle is fully encased in flexible vinyl for protection against abrasion and wear. The low stretch 16-strand 30-filament rope floats and has a 5 ft. handle bridle and three 10 foot take-offs (5, 35, 10, 10, 10) for all riding styles. A Rope Keeper is included for tangle-free storage.



PART #	MFG #	U/M	DESCRIPTION	
966368	AHWR-1	EA	AIRHEAD Wakeboard Rope, Phat Grip, yellow	43.99 J
966372	AHWR-2	EA	AIRHEAD Wakeboard Rope, Phat Grip, red	43.99 J



### SPECTRA THERMAL WAKEBOARD ROPE

AIRHEAD's Spectra Thermal wakeboard rope provides zero stretch for the crisp instantaneous response that expert wakeboard riders demand. The Thermal-coated Spectra line is stiff and rigid, resists kinking and twisting, floats and boasts a 2,000 lb. break strength. It's 70 foot long with a 5 foot handle bridle and 4 section mainline (5,50,5,5,5). The 15 inch wide EVA grip is equipped with 2 foam floats and full length PVC tubing for added durability. A Rope Keeper is included for tangle-free storage.

PART #	MFG #	U/M	DESCRIPTION	
966374	AHWR-4	EA	AIRHEAD Spectra Thermal Wakeboard Rope	99.99 J

### BLING STEALTH WAKEBOARD ROPE

This wakeboard rope will give you swagger! It sparkles in the sun and glows in twilight! The extravagant look compliments the luxury of high end boats, adds a little class to lesser boats and makes you look like a watersports pro! BLING series ropes are one of a kind, shiny and reflective material is braided together with top quality polypropylene. This 75 foot wakeboard rope has 4 take-off sections, 5ft, 5ft, 10ft and 10ft., resulting in rope lengths of 75 ft., 70 ft., 65 ft., 55 ft. and 45 ft.. The handle has an aluminum core, a 15" EVA squid grip and full finger protectors.



PART #	MFG #	U/M	DESCRIPTION	
966369	AHWR-11BL	EA	AIRHEAD Stealth Wakeboard Rope	43.99 J

### BLING SPECTRA WAKEBOARD ROPE

These wakeboard ropes will give you swagger! They sparkle in the sun and glow in twilight! The extravagant look compliments the luxury of high end boats, adds a little class to lesser boats and makes you look like a watersports pro! BLING series ropes are one of a kind. Shiny and reflective material is braided together with top quality Poly E over a Spectra core. These 75 foot wakeboard ropes have 4 take-off sections, 5ft, 5ft, 10ft and 10ft., resulting in rope lengths of 75 ft., 70 ft., 65 ft., 55 ft. and 45 ft.. The spectra core gives this tiny rope a phenomenal 2,000 lb. break strength and no stretch. The handle has an aluminum core, a 15" EVA grip and full finger protectors.



PART #	MFG #	U/M	DESCRIPTION	
966370	AHWR-12BL	EA	AIRHEAD Spectra Wakeboard Rope, yellow	91.99 J
966371	AHWR-13BL	EA	AIRHEAD Spectra Wakeboard Rope, blue	91.99 J



**AIRHEAD®  
AIR PUMPS**



**AIR PUMP**

This 120 volt canister style air pump inflates and deflates towables, pools, air mattresses and beach toys. The accordion-style hose locks onto the pump and valve fittings, eliminating annoying disconnections. Three universal valve fittings fit all popular valves. For added convenience, there's a carry handle and a 10 ft. long power cord. Volume is 300 liters/minute, maximum pressure is .92 psi. It draws 1.6 amps / 170 watts.

PART #	MFG #	U/M	DESCRIPTION		
966197	AHP-120	EA	AIRHEAD AIR PUMP 120V	39.99	J

**HI-PRESSURE AIR PUMP**

You'll enjoy the performance of this 120 volt air pump. It inflates and deflates quickly and effectively. Peak pressure is 2.5 psi, plenty of pressure to get high end inflatable boats, rafts and reinforced backyard items nice and firm. You'll immediately notice how they perform better when properly inflated. A Pressure Release Valve is included to limit pressure to 1.4 psi for preventing over-inflating towables, pool toys and other vinyl and nylon covered inflatable items. The accordion-style hose locks onto the pump, eliminating annoying disconnections. Four universal valve fittings fit all popular valves and lock onto the hose. You'll love the screw-on Boston Valve adapter, an AIRHEAD exclusive. For added convenience, there's a carry handle and a 10 ft. long power cord. Draws 6.1 amps / 730 watts. Volume is 460 liters/minute.



PART #	MFG #	U/M	DESCRIPTION		
966198	AHP-120HP	EA	AIRHEAD Hi-Pressure Air Pump	59.99	J



**SUPER HI-PRESSURE AIR PUMP**

Just dial in the pressure, 1-20 psi and walk away! Plenty of pressure for inflatable SUPs! 12 volt, connects to battery with alligator clips.

PART #	MFG #	U/M	DESCRIPTION		
966694	AHSUP-A022	EA	AIRHEAD Super High Pressure Air Pump, 12V, 20 PSI	159.99	J

**SUPER PUMP™**

This is the best performing 120 volt air pump available, inflating and deflating at unprecedented speed. Peak pressure is nearly 3.0 psi, plenty of pressure to get boats, dinghys, rafts and reinforced backyard items nice and firm. Four universal adapters are provided to fit all valves commonly used on boats, kayaks, towables and other inflatables. The adapters lock onto the 36 inch long heavy duty reinforced hose. A Pressure Release Valve is included to limit pressure to 1.4 psi for preventing over-inflating towables, pool toys and other vinyl and nylon covered inflatable items. The accordion-style hose locks onto the pump, eliminating annoying disconnections. You'll love the convenience of the screw-on Boston Valve adapter, an AIRHEAD exclusive. For added convenience, there's a carry handle and a 10 ft. long power cord. It draws 7.1 amps / 917 watts. Volume is 480 liters/minute.



PART #	MFG #	U/M	DESCRIPTION		
966199	AHP-120S	EA	AIRHEAD Super Pump, 120V	79.99	J

- accessories
- towables
- body
- controls
- electrical
- driveline
- engine
- fuel & intake
- chemicals
- tie downs
- tools
- towing & loading

MARINE



### 12 VOLT HIGH PRESSURE PUMP

AIRHEAD's 12 Volt Hi Pressure Air Pump w/ Pressure Release Valve produces 3 times the pressure of other 12 volt air pumps. Therefore it does a great job getting towables, boats and rafts nice and firm for peak performance. Five universal valve fittings fit all popular valves and lock onto the hose. A removable pressure release valve limits the output to 1.4 psi, the perfect inflation pressure for towables. The 21" hose is heavy duty and reinforced with PVC coils. This powerful pump draws too many amps to plug into a cigarette lighter style outlet. Hook it up to your car, truck or boat battery with the alligator clips connected to a 10 foot power cord. Volume is 410 liters/min. Maximum pressure is 2.5 PSI It draws 28 amps / 340 watts.



PART #	MFG #	U/M	DESCRIPTION		
966201	AHP-12HP	EA	AIRHEAD Hi Pressure Air Pump, 12V	69.99	J



### AIR PIG 120V PUMP

This pump is called AIRHEAD AIR PIG to extol its high volume, high pressure capabilities. (It also happens to be shaped like a piggy bank!) The quiet motor puts out 2.2psi, plenty of pressure for most inflatables, including towables, boats, lounges and pool toys. Equipped with a 10' power cord with AC plug and a 24" reinforced hose. Four adapters for the most popular air valves are included. Draws 3.5 amps / 470 watts.

PART #	MFG #	U/M	DESCRIPTION		
966668	AHP-120AP	EA	AIRHEAD Air Pig Pump, 120V	46.99	J

### AIR PIG 12V PUMP

This pump is called AIRHEAD AIR PIG to extol its high volume, high pressure capabilities. (It also happens to be shaped like a piggy bank!) The quiet motor puts out 1.2psi, plenty of pressure for most inflatables, including towables, boats, lounges and pool toys. Equipped with a 10' power cord with alligator clips and a 24" reinforced hose that locks onto the pump. Four adapters for the most popular air valves are included. Draws 22 amps / 260 watts.

PART #	MFG #	U/M	DESCRIPTION		
966669	AHP-12AP	EA	AIRHEAD Air Pig Pump, 12V	55.99	J



### AIR DADDY™

AIR DADDY lets you get to the fun times more quickly! It allows you to inflate towables, swim toys, beach toys, inflatable boats, rafts, air beds and sport balls with an air compressor at home or at a gas station. AIR DADDY is a universal adapter tapered to fit all valves found on inflatables, including all sizes of stem valves and Boston valves, Halkey-Roberts and Leaffield valves. The screw-on tip creates a high pressure stream of air, perfect for workshops and garages. Soccer ball or football low on air? Stop by a gas station and use AIR DADDY's needle valve! Both the needle valve and high pressure tip stow securely in the handle.

PART #	MFG #	U/M	DESCRIPTION		
966138	AHAD-1	EA	AIRHEAD Air Daddy	5.99	J



- accessories
- towables
- body
- controls
- electrical
- driveline
- engine
- fuel & intake
- chemicals
- tie downs
- tools
- towing & loading

**AIRHEAD®  
AIR PUMPS**



**RECHARGEABLE 12 V AIR PUMP**

This convenient and versatile 12 volt air pump comes equipped with a 120 volt AC charger and a 12 volt charger that plugs into cigarette lighters. When charged, there are no cords to deal with. It's equipped with 3 adapters to fit valves on towables, pool toys, airbeds and other inflatables. It will inflate or deflate continuously for 15 minutes on a charge. Peak air pressure is .64 psi, volume is 260 liters/minute. It draws 11.3 amps / 75 watts. We recommend "topping off" large towables inflated with this pump with a few strokes of AIRHEAD's Double Action Hand Pump or Foot Bellows Pump.



PART #	MFG #	U/M	DESCRIPTION	
966202	AHP-12R	EA	AIRHEAD Rechargeable Air Pump	39.99 J

**12V AIR PUMP**



This high-volume 12 volt portable air pump inflates and deflates towables, boats, pools, mattresses and beach toys quickly. Most pumps on the market don't put out this kind of air volume and pressure. The universal valve fittings fit many popular valves including Boston valves and stem valves. For added convenience, the accessory power plug is equipped with a 10 ft. long power cord. Volume is 380 liters/minute. Maximum pressure: 1.2 psi. Draws 11.8 amps / 145 watts. We recommend "topping off" large towables inflated with this pump with a few strokes of AIRHEAD's Double Action Hand Pump or Foot Bellows Pump.

PART #	MFG #	U/M	DESCRIPTION	
966200	AHP-12H	EA	AIRHEAD Air Pump 12V	20.98 J



**SUPER HIGH PRESSURE  
HAND PUMP - 15 PSI**

Inflates inflatable SUPs to optimal pressure! High pressure, up to 15 PSI! Manometer/ air pressure gauge included.



PART #	MFG #	U/M	DESCRIPTION	
966695	AHSUP-A023	EA	AIRHEAD Super High Pressure Hand Pump, 15 PSI	39.99 J

**DOUBLE ACTION HAND PUMP**

This double action pump inflates and deflates towables, kayaks, boats, airbeds, and other inflatables. It delivers a continuous stream of air on both the up and down strokes. Simply turn the release valve counter-clockwise and you're pumping air only on the down-stroke. This is a great option when your inflatable is almost full and there's back pressure. Four universal valve fittings are included to fit Boston valves and stem valves. The accordion-style hose stretches to 5 ft. long and interlocks to the pump, so that it doesn't fall off while you're pumping. Volume is 2 liters / stroke. Very effective for "topping off" large towables in the boat, since peak pressure is an impressive 14 psi.



PART #	MFG #	U/M	DESCRIPTION	
966196	AHP-1	EA	AIRHEAD Double Action Hand Pump	22.99 J

- accessories
- towables**
- body
- controls
- electrical
- driveline
- engine
- fuel & intake
- chemicals
- tie downs
- tools
- towing & loading

MARINE



### BELLOWS ACTION FOOT PUMP

Use your foot to inflate or deflate towables, boats and other inflatables with AIRHEAD's HI-Volume Bellows Action Foot Pump. This durable air pump has a 54" long hose and 3 adapters to fit many valves including Boston and stem. The air displacement per stroke is 0.5 liters. Since the pump achieves a maximum air pressure of 2.9 psi, you can get your inflatable boats and towables nice and firm. It conveniently collapses to fit under kayak decks or boat seats, so it's a good choice for "topping off" large towables in your boat.



PART #	MFG #	U/M	DESCRIPTION		
966204	AHP-F1	EA	AIRHEAD Foot Pump	18.99	J

### MULTI-VALVE

AIRHEAD MULTI-VALVE consists of 2 Boston valves with different thread patterns on the bottom and a Shrader valve with cap. One of the Boston valves is sure to fit the thread pattern of your inflatable, no matter what brand. The Boston Valves have a square base, which is much easier to turn than a round base, especially with wet hands. Use the Shrader valve to inflate your inflatables at a gas station or with an air compressor. Alternatively, screw off the Shrader valve and inflate the Boston valve with an AIRHEAD air pump. All components are bright red and green, so they're easy to find.

PART #	MFG #	U/M	DESCRIPTION		
966192	AHMOV-1	EA	AIRHEAD Multi-Valve, Blister Pack	7.99	J

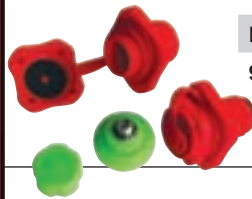
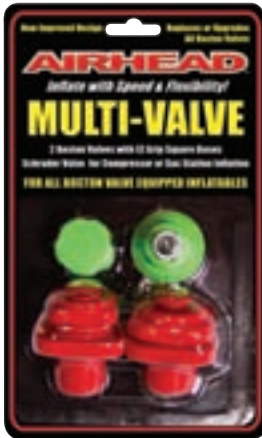

### BOSTON VALVES

Always Carry a Spare! The 2 Boston valves have different thread patterns. One is sure to fit the thread pattern of your inflatable, no matter what brand. They have square bases, which are much easier to turn than round, especially with wet hands. Bright red, so they're easy to find.

PART #	MFG #	U/M	DESCRIPTION		
966154	AHBV-2	EA	AIRHEAD Boston Valve, 2 pk.	5.99	J



### VINYL REPAIR KIT

Are you rough on your inflatables? Better keep a repair kit handy! This kit includes a 1-ounce tube of the best commercial grade vinyl cement available and 4 - 2" round vinyl patches. Blister packed.

PART #	MFG #	U/M	DESCRIPTION		
966211	AHRK-1	EA	AIRHEAD Vinyl Repair Kit	4.99	J



### AIR PRESSURE GAUGE

Ensure that your inflatables are inflated to the proper pressure for peak performance with AIRHEAD's Air Pressure Gauge. Maybe even more importantly, protect your investment by not overinflating them, causing irreparable damage. AIRHEAD's Air Pressure Gauge monitors air pressure from 0 - 5 psi with precision.

PART #	MFG #	U/M	DESCRIPTION		
966667	AHPG-1	EA	AIRHEAD Pressure Gauge	17.99	J





## SPORTSSTUFF TOWABLES

### CHARIOT DUO

CHARIOT DUO is an exhilarating 2 rider towable tube! Fold down the leg rests and it's a super comfortable lounge! Everyone will have a great time riding it tandem chariot style. When you're all tired out, put your legs up and relax in style with your favorite beverage. There's a cooler in the center and 2 cup holders. Constructed of rugged double stitched nylon with a heavy gauge PVC bladder. Comfortable tubular nylon handles with knuckle guards provide a sure and comfortable grip. Features the patented Speed Safety Valve for the ultimate in inflating and deflating convenience. Patented Speed Safety Valve.



**Features:**

- Foam Handles with Knuckle Guards
- Quick Connect Tow Point
- Towable / Lounge Dual Functionality
- Fold Out Footrest
- Zippered Cooler
- Two Drink Holders

**NEW  
PRODUCT**

Cover Full Nylon  
Max Capacity 2 Riders  
Length (deflated) 69 in. x 60 in.

PART #	MFG #	DESCRIPTION	
968070	53-1982	CHARIOT DUO	299.99 J

### POPARAZZI / POPARAZZI 2

The POPARAZZI has a unique, high winged shape with rocker bottom that allows you to carve into the wake and glide across the water's surface with minimal drag. With a turn of the boat, inside riders will teeter deep into the wake while the other riders will rise high above it! Multiple EVA foam body pads allow riders to comfortably perform every riding position imaginable. The unique High Rise Tower equipped with multiple double webbing foam handles with knuckle guards allow standing or kneeling on the back deck. The convenient Quick Connect tow point will get you started in a flash and Speed Safety Valves allow the quickest inflation and deflation possible. Stand, sit, kneel, steer, lay, balance and freestyle on this amazing ride! High Rise Tower on Rear Deck.

**Features:**

- Heavy-Duty Full Nylon Cover with Zipper
- Heavy-Duty K80 PVC Bladder
- Speed Safety Valve
- Quick Connect Tow Point
- Rocker Bottom Design
- Double Webbing Foam Handles with Knuckle Guards



PART #	MFG #	DESCRIPTION	
966077	53-1750	POPARAZZI	589.99 J



PART #	MFG #	DESCRIPTION	
968067	53-1752	POPARAZZI 2	429.99 J

- accessories
- towables**
- body
- controls
- electrical
- driveline
- engine
- fuel & intake
- chemicals
- tie downs
- tools
- towing & loading

MARINE



## SPORTSSTUFF TOWABLES

accessories

towables

body

controls

electrical

driveline

engine

fuel & intake

chemicals

tie downs

tools

towing & loading

Mild or Wild?! SPORTSTUFF's POPA WHEELIEs deliver both! Connect the Kwik-Connect to the Mild Tow Point (front) for a conventional tube ride. Connect it to the Wild Tow Point (bottom) for a wild ride. In the Mild position the tube stays pretty flat on the water and effortlessly crosses the wakes. In the Wild position, the front lifts up and hence the name Popa Wheelie! Little ones will enjoy the comfortable backrests and "Cadillac ride". Teenagers will have the time of their lives popping wheelies around the lake! Rugged double stitched nylon cover and heavy gauge PVC bladder. Patented Speed Safety Valve for the ultimate in inflating and deflating convenience.



### POPA WHEELIE

Cover Full Nylon  
Max Capacity 2 Riders  
Length (deflated) 78 in. x 65 in.

PART #	MFG #	DESCRIPTION	
968068	53-1922	POPA WHEELIE	299.99 J



#### Features:

- Dual Tow Points for MILD & WILD!
- EVA Foam Padded Seats
- Speed Safety Valve
- Heavy Duty Full Nylon Cover
- Interchangeable Kwik-Connect Tow Point
- Multiple Double Webbing Foam Handles with Knuckle Guards
- Self Bailing Drain Vents



### SUPER POPA WHEELIE



Cover Full Nylon  
Max Capacity 3 Riders  
Length (deflated) 79 in. x 89 in.

PART #	MFG #	DESCRIPTION	
968069	53-1933	SUPER POPA WHEELIE	419.99 J



POPA WHEELIE AND  
SUPER POPA WHEELIE  
BOTH HAVE KWIK-  
CONNECT TOW SYSTEM



## SPORTSSTUFF TOWABLES



- accessories
- towables**
- body
- controls
- electrical
- driveline
- engine
- fuel & intake
- chemicals
- tie downs
- tools
- towing & loading

### BIG BETTY SERIES

The new BIG BETTY series of towables is an off shoot from our popular MABLE series with the added feature of dividers between riders. It will continue to impress you with a variety of different riding options. Featuring dual tow points, you can go for a fun filled ride without the threat of banging into each other, utilizing the comfy backrest and the easy grips mounted on the dividers. Or tow them the opposite direction for a chariot style blast you'll never forget! All three sizes come equipped with comfy EVA foam seating pads. A multitude of foam filled webbing handles with knuckle guards enable lots of different riding positions. Air cushioned sidewalls help keep you on board. The patented Speed Safety Valve and Quick Connect will save you time. The BETTY's feature a heavy-duty K80 PVC bladder and double stitched full nylon cover with self bailing drain vents. They also make the perfect deluxe lounge at any pool, beach, lake, or river.



**NEW  
PRODUCT**

#### BIG BETTY 2 RIDERS

**Features:**

- Front & Back Tow Points
- Air Cushioned Dividers
- Speed Safety Valves
- Quick Connect Tow Point
- Full Nylon Cover
- EVA Foam Pads
- Self Bailing Drain Vents
- Air Cushioned Side Walls
- Foam Handles with Knuckle Guards
- 75 in. x 65 in. (deflated)



PART #	MFG #	DESCRIPTION		
968071	53-3002	BIG BETTY	369.99	J



**NEW  
PRODUCT**

#### SUPER BETTY 3 RIDERS

**Features:**

- Front & Back Tow Points
- Air Cushioned Dividers
- Speed Safety Valves
- Quick Connect Tow Point
- Full Nylon Cover
- EVA Foam Pads
- Self Bailing Drain Vents
- Air Cushioned Side Walls
- Foam Handles with Knuckle Guards
- 79 in. x 78 in. (deflated)



PART #	MFG #	DESCRIPTION		
968072	53-3003	SUPER BETTY	479.99	J



**NEW  
PRODUCT**

#### GREAT BIG BETTY 4 RIDERS

**Features:**

- Front & Back Tow Points
- Air Cushioned Dividers
- Speed Safety Valves
- Quick Connect Tow Point
- Full Nylon Cover
- EVA Foam Pads
- Self Bailing Drain Vents
- Air Cushioned Side Walls
- Foam Handles with Knuckle Guards
- 93 in. x 85 in. (deflated)



PART #	MFG #	DESCRIPTION		
968073	53-3004	GREAT BIG BETTY	599.99	J

MARINE



### BIG MABLE

#### BIG, NEW & IMPROVED MABLE!

The Big Mable is back and better than ever! This next generation Mable for 1 to 2 riders has a Redesigned Backrest, and added Air Cushioned Side Walls to keep you on board around every whip and turn. Dual Tow Points allow for 2 completely different riding experiences. Sit, lay, stand, or kneel while towing forwards like a deck tube or backwards like a chariot. Tons of Double Webbing Foam Handles with Knuckle Guards and EVA Foam Seating Pads provide a comfortable ride that will keep you coming back for more. Sportsstuff's patented Speed Safety Valve and Aluminum Quick Connect Tow point will save you time to keep on the water longer. This uniquely shaped classic towable features a Heavy Gauge PVC Bladder and Double Stitched Full Nylon cover with all new Custom Graphics. Multi-functional is the Big Mable's middle name, whether its providing a unique towable riding experience or making the perfect lounge at any pool, beach, lake or river!

#### Features:

- Dual Tow Points: Front & Back
- New Air Cushioned Stabilizer Walls
- Unique Backrest/Front Riser Construction
- Multiple Riding Positions
- Heavy-Duty Full Nylon Cover with Zipper
- Patented Aluminum Quick Connect Tow Point
- EVA Foam Pads
- Multiple Grab Handles with Knuckle Guards
- Speed Safety Valve
- 69" x 66"



PART #	MFG #	DESCRIPTION		
966102	53-2213	SPORTSSTUFF BIG MABLE	339.99	J

### SUPER MABLE

#### SUPER, NEW & IMPROVED MABLE!

The next generation Super Mable from Sportsstuff is here! Built for 1 to 3 riders, this new and improved classic towable will continue to impress you with a variety of different riding options. Featuring Dual Tow Points, you can go for a wild ride utilizing the comfy backrest or tow it the opposite direction for a chariot style blast on the water you'll never forget. This action packed towable comes equipped with comfy EVA Foam Seating Pads and a magnitude of Double Webbing Foam Handles with Knuckle Guards to enable tons of different riding positions. The addition of Air Cushioned Side Walls will keep you on board while the Redesigned Backrest and new Custom Graphics make this uniquely shaped towable dressed to impress. Experience an exciting day of towable action on the Super Mable or put your feet up and relax using it as a deluxe lounge.

#### Features:

- Dual Tow Points: Front & Back
- New Air Cushioned Stabilizer Walls
- Unique Backrest/Front Riser Construction
- Multiple Riding Positions
- Heavy-Duty Full Nylon Cover with Zipper
- Patented Aluminum Quick Connect Tow Point
- EVA Foam Pads
- Multiple Grab Handles with Knuckle Guards
- Speed Safety Valve
- 79" x 78"



PART #	MFG #	DESCRIPTION		
966104	53-2223	SPORTSSTUFF SUPER MABLE	429.99	J

### GREAT BIG MABLE

The new and improved classic MABLE towables will continue to impress you with a variety of different riding options. Featuring dual tow points, you can go for a wild ride utilizing the comfy backrest or tow them the opposite direction for a chariot style blast you'll never forget. All three sizes come equipped with comfy EVA foam seating pads. A multitude of double webbing foam handles with knuckle guards enable lots of different riding positions. The addition of air cushioned side walls will keep you on board while the redesigned backrest and new custom graphics make this uniquely shaped towable dressed to impress. The patented Speed Safety Valve and aluminum Quick Connect tow point will save you time. The MABLEs feature a heavy-duty K80 PVC bladder and double stitched full nylon cover with self bailing drain vents. They also make the perfect deluxe lounge at any pool, beach, lake, or river. 1-4 rider, 93" x 85" (deflated) 80" x 87" (inflated)

PART #	MFG #	DESCRIPTION		
966103	53-2218	SPORTSSTUFF GREAT BIG MABLE	519.99	J



accessories

towables

body

controls

electrical

driveline

engine

fuel & intake

chemicals

tie downs

tools

towing & loading

MARINE

**SPORTSSTUFF  
TOWABLES**



- accessories
- towables**
- body
- controls
- electrical
- driveline
- engine
- fuel & intake
- chemicals
- tie downs
- tools
- towing & loading

**HIGH ROLLER SERIES**

Prepare for exciting hydroplaning action with Sportsstuff HIGH ROLLERS! Available in 2, 3 and 4 rider models, the unique multi sphere design barely touches the water while towing. The strategically placed air chamber on the back top edge supports knees and feet for comfortable positioning through whips and turns. Large EVA foam body pads protect riders' knees and legs. A multitude of foam filled handles with EVA knuckle pads provide lots of options for comfortable gripping. Equipped with the Speed Safety Valve and a Quick Connect for quick and easy rope hook-ups.



**NEW  
PRODUCT**



**HIGH ROLLER 2  
2 RIDERS**

**Features:**

- Heavy-Duty Full Nylon Cover with Zipper
- Heavy-Gauge PVC Bladder with RF welded seams
- Deluxe nylon handles with neoprene knuckle guards
- Quick Connect tow point for fast hook-ups
- Speed Safety Valves
- Unique multi sphere design
- EVA Foam Body Pads
- 81 in x 70 in (deflated)

PART #	MFG #	DESCRIPTION	
968074	53-3020	HIGH ROLLER 2	359.99 J



**NEW  
PRODUCT**



**HIGH ROLLER 3  
3 RIDERS**

**Features:**

- Heavy-Duty Full Nylon Cover with Zipper
- Heavy-Gauge PVC Bladder with RF welded seams
- Deluxe nylon handles with neoprene knuckle guards
- Quick Connect tow point for fast hook-ups
- Speed Safety Valves
- Unique multi sphere design
- EVA Foam Body Pads
- 115 in x 70 in (deflated)

PART #	MFG #	DESCRIPTION	
968075	53-3030	HIGH ROLLER 3	529.99 J



**NEW  
PRODUCT**



**HIGH ROLLER 4  
4 RIDERS**

**Features:**

- Heavy-Duty Full Nylon Cover with Zipper
- Heavy-Gauge PVC Bladder with RF welded seams
- Deluxe nylon handles with neoprene knuckle guards
- Quick Connect tow point for fast hook-ups
- Speed Safety Valves
- Unique multi sphere design
- EVA Foam Body Pads
- 149 in X 70 in (deflated)

PART #	MFG #	DESCRIPTION	
968076	53-3040	HIGH ROLLER 4	699.99 J

**MARINE**

- accessories
- towables
- body
- controls
- electrical
- driveline
- engine
- fuel & intake
- chemicals
- tie downs
- tools
- towing & loading



## SPORTSSTUFF TOWABLES

### 4K BOOSTER BALL

ADVANCED TOWING SYSTEM includes 4K Booster Ball and Custom Tow Rope (Overall length with Booster Ball is 60FT.)

We have developed the 4K Booster Ball, an inflatable buoy with tow rope connected to both ends, as a way of keeping the tow rope out of the water the majority of the time while towing. This enhances the overall performance of most towables & all our new DOABLES. The Booster is a hybrid towing system for more effortless towing of inflatable Doable/towables.

**Key Enhancements:**

1. Reduces drag and acts like shock absorber, enhancing fuel economy
2. Less stress on tube and cover
3. Great for low transom tow points
4. Reduces rope spray
5. Higher visibility of tow rope in the water
6. Tow rope is less likely to get caught in water or boat wake, especially in turns

**Features:**

- Enhances the performance of all Doables and most regular towables.
- Heavy-Gauge PVC Bladder
- 840 Denier Full Nylon Cover with Zipper
- Tough 2 Inch Webbing
- Exclusive Patented Speed Safety Valve
- 60 Foot Overall Length (including Booster Ball)
- Double Stitching and Reinforced Stress Points
- Self Bailing Drain Vent
- 4k Tow Rope 4100 lb. Break Strength
- Designed for 1 to 4 Person Towables



PART #	MFG #	U/M	DESCRIPTION		
966095	53-2030	EA	SPORTSSTUFF 4K BOOSTER BALL	129.99	J



### MASTER BLASTER INFLATABLE THREE RIDER TOWABLE

MASTER BLASTER's ride is just as exciting as its awe inspiring shape! Hop on and you'll feel like you're rocketing to the moon! 1, 2 or 3 riders? No problem. Ten comfortable tubular webbing handles with knuckle guards ensure a great grip for all riders. A Quick Connect makes connecting and disconnecting the tow rope a breeze. Soft EVA topside panels are provided for extra comfort. The tough 30 gauge PVC bladder is fully encased with durable double stitched 840 denier nylon to ensure long service. Quickly inflate and deflate with the patented Speed Safety Valve. Size: 3 rider, 95 in. x 75 in. deflated.

PART #	MFG #	U/M	DESCRIPTION		
966655	53-1831	EA	SPORTSSTUFF MASTER BLASTER	369.99	J

**SPORTSSTUFF  
TOWABLES**



**SUMO TUBE™  
INCLUDES SUMO SPLASH  
GUARD™**

The SUMO TUBE is the world's only freestyle towable that you wear! This single chamber tube is made of 100% heavy-duty K80 PVC and is put over the rider like a shirt, instead of being directly attached to the boat. Take it to the beach for the ultimate body surfing experience, or grab two SUMOS and have a SUMO wrestling match with a friend! The SUMO SPLASH GUARD (included) is an inflatable armrest/handle with a sleek splash-deflecting design that will keep the spray out of your face. Featuring 6 double webbing foam handles and EVA foam knuckle guards on a heavy-duty full nylon cover. Simply connect a standard tow rope to the SUMO SPLASH GUARD and you can steer the SUMO TUBE back and forth, jump the wake, and roll 360s! They both come equipped with the Speed Safety Valve for fast inflation to get you on the water in a hurry.



SUMO TUBE Size: 1 rider, 38 in. x 32 in. (deflated) 33 in. x 33 in. (inflated)  
SUMO SPLASH GUARD Size: 35 in. x 22 in. (deflated) 29 in. x 16 in. (inflated)

PART #	MFG #	U/M	DESCRIPTION		
966082	53-1807	EA	SPORTSSTUFF SUMO TUBE w/Splash Guard	189.99	J

**GYRO**

**TUMBLING ACTION!**

Prepare for some serious tumbling excitement with this unique towable that you won't find anywhere else! The bullet-shaped GYRO will be sent into a spin with a simple turn of the boat. The stainless steel swivel tow system allows the GYRO to roll over and over again with the rider inside while they watch all the action through the port hole at the front of the tube. The GYRO is constructed of heavy-duty K80 PVC featuring the patented Speed Safety Valve so you can inflate and deflate this state-of-the-art towable in no time at all. Riders simply hold on to the molded PVC handle system located in the front of the tube and enjoy the ride. Watch out, not for the faint of heart!

**Features:**

- 360° swivel tow point
- Transparent Body for Rider Visibility
- Viewing Porthole
- Heavy-Gauge PVC Construction
- One Chamber Inflation
- Speed Safety Valve
- Molded Handle System
- Barrel Rolling Functionality
- 56" x 37"



PART #	MFG #	DESCRIPTION		
966083	53-1818	SPORTSSTUFF GYRO	199.99	J

- accessories
- towables**
- body
- controls
- electrical
- driveline
- engine
- fuel & intake
- chemicals
- tie downs
- tools
- towing & loading

**MARINE**



## SPORTSSTUFF TOWABLES

### HALF PIPE RAMPAGE™ & FRANTIC™

Enjoy the amazing HALF PIPE series sitting, kneeling, lying down, or even sideways! The high angled sides give this tube sensational action while maintaining a great deal of stability. Featuring a heavy-duty full nylon cover, and EVA foam body pads for each rider. There are multiple flat foam boarding handles for each rider as well as double webbing foam handles with knuckle guards. A simple single chamber design with Speed Safety Valve makes inflation and deflation fast and easy. Includes reinforced tow system and self-bailing drain vents.

**966096:** 1-2 rider, 68 in. x 100 in. (deflated) 69 in. x 70 in. (inflated)

**966097:** 1-3 rider, 80 in. x 112 in. (deflated) 80 in. x 80 in. (inflated)



RAMPAGE



FRANTIC

PART #	MFG #	U/M	DESCRIPTION		
966096	53-2155	EA	SPORTSSTUFF HALF PIPE RAMPAGE	329.99	G
966097	53-2160	EA	SPORTSSTUFF HALF PIPE FRANTIC	399.99	G

### MIXMASTER

#### SPINABLE

Get ready to mix it up! The MIXMASTER is Sportsstuff's newest controllable Doable. The unique geometric construction with rocker bottom design will allow you to perform multiple spins and slaloms like never before. To spin simply rock forward and back to catch the Tiger Tooth Fins in the water or slalom the Mixmaster by leaning away from the boat in the direction you want to drive. This DOABLE is packed with features you won't find on any other "normal" towable. Old style towables use a front mounted tow point to pull the tube but DOABLES use an innovative, centrally located VEER Tow System on bottom that allows perfect balance and control to spin, steer, and slalom. Spin on-the-water 540's, 900's, or jump the wake and go for a 360 aerial while the boat simply drives straight. No other towable even comes close. You control Skill Tubing,™ where anything is DOABLE!

#### Features:

- Patented VEER Towing System
- Patent Pending Rocker Bottom Design
- Patent Pending Tiger Tooth Spinning/Steering Fins
- Unique Shape Custom Geometric Construction
- Heavy-Duty Full Nylon Cover with Zipper
- Patented Aluminum Quick Connect Tow Point with Swivel
- EVA Foam Padded Floor
- Multiple Grab Handles with Knuckle Guards
- Patented Speed Safety Valve for Fast Inflation and Deflation



PART #	MFG #	U/M	DESCRIPTION		
966057	53-1265	EA	SPORTSSTUFF MIXMASTER 1	239.99	J

**SPORTSSTUFF  
TOWABLES**



**SPORTSSTUFF® SIDEKICK™ 2 & 3**

These super agile cockpit towables will sharpen all your reflexes, and are available in 2 & 3 rider models. Featuring deep and spacious cockpits for maximum stability, air cushioned floors for comfort, and multiple double webbing foam handles with knuckle pads to protect your hands when you're holding on tight. The unique aerodynamic construction gives the SIDEKICKs lightning speed. The aluminum Quick Connect tow point makes attaching and detaching your tow rope quick and easy, to keep you on the water longer. Patented Speed Safety Valves allow the fastest inflation and deflation possible. A heavy-duty full nylon cover with self bailing drain vents is standard on these luxurious towables.

966098: 2 rider, 81 in. x 69 in. (deflated) 75 in. x 63 in. (inflated)

966099: 1-3 rider, 72 in. x 110 in. (deflated) 104 in. x 66 in. (inflated)



PART #	MFG #	DESCRIPTION		
966098	53-2172	SPORTSSTUFF SIDEKICK 2	249.99	J
966099	53-2173	SPORTSSTUFF SIDEKICK 3	349.99	J



**ROCKIN' MABLE & ROCKIN' SUPER MABLE**

You'll be the envy of the lake with SPORTSSTUFF's ROCKIN' MABLE or ROCKIN' SUPER MABLE! The MABLE series has been one of the world's most popular towables since its inception. We've raised the bar with ROCKIN' MABLE and ROCKIN' SUPER MABLE. They have all of the same popular features as the MABLES, but with a convex bottom surface that provides super fun rockin' action! ROCKIN' MABLES slide effortlessly side-to-side, so the kids will have more fun, even at slow speeds. They're 2 tubes in 1, ride them sitting down or kneeling! The big wrap around backrest, soft knee/seat pads and a magnitude of strategically placed handles keep you on the tube, no matter how wild the action! The front & rear Dual Tow Points are equipped with SPORTSSTUFF's patented aluminum Quick Connects for easy hook-ups. This tube is built to last, with a double-stitched 840 denier nylon cover and 30 gauge vinyl bladder. Inflating and deflating is a snap with the 2 patented Speed Safety Valves.

966107: 1-2 rider, 66in x 62in ( deflated)

966108: 1-3 rider, 80in x 62in ( deflated)



PART #	MFG #	U/M	DESCRIPTION		
966107	53-2262	EA	SPORTSSTUFF ROCKIN' MABLE	329.99	J
966108	53-2263	EA	SPORTSSTUFF ROCKIN' SUPER MABLE	399.99	J



- accessories
- towables**
- body
- controls
- electrical
- driveline
- engine
- fuel & intake
- chemicals
- tie downs
- tools
- towing & loading

MARINE



### WACKY WHOPPER

Get whacky on SPORTSSTUFF's WACKY WHOPPER! Its dual wave shape provides incredible excitement for 1, 2 or 3 riders. Be sure to switch positions often, as the ride in the center, suspended high above the water is a completely different sensation than riding on the sides. Take turns riding Wacky Whopper lying down or sitting up, there are plenty of handles to hold onto. Soft and comfortable knee and elbow pads are strategically positioned for peak performance. Wacky Whopper is equipped with a patented Speed Safety Valve for convenient inflating and deflating and a heavy-duty aluminum Quick Connect for easy hook-ups. The rugged double-stitched 840 denier nylon cover and 30 gauge vinyl bladder ensure long service. WACKY WHOPPER's dual wave shape and extra large size, 94 x 70in. (deflated size), make it a super comfortable lounge, that is if you can get the kids off it!  
966109: 1-3 rider, 94in x 70in (deflated)



PART #	MFG #	U/M	DESCRIPTION		
966109	53-5153	EA	SPORTSSTUFF WACKY WHOPPER	389.99	G

### BRAINWASH TOWABLE, ROPE & PUMP

Everything you'll need for tubing, except for a boat, a life jacket, family and friends is included. The 12 volt air pump quickly inflates towables to optimal pressure and deflates just as fast. The color coordinated tube tow rope comes with a convenient Rope Keeper. The deluxe tubular webbing handles with knuckle guards provide a sure and comfortable grip. The heavy-duty virgin PVC bladder has electronically welded seams and a patented Speed Safety Valve for quick inflating and deflating. BRAINWASH has a double stitched nylon cover, double reinforced internal tow harness and a self-draining floor vent.  
Size: 1 rider, 48in diameter (deflated)



PART #	MFG #	U/M	DESCRIPTION		
966656	53-6501	EA	SPORTSSTUFF BRAINWASH TOWABLE	119.99	J





SPORTSSTUFF  
TOWABLES



SPORTSSTUFF® GRANDSTAND™ 1 & 2

Stand up and shout on the amazing GRANDSTANDS! These one of a kind towables feature a unique dragless nose design for effortless towing and an aluminum Quick Connect tow point to get your tow rope hooked up in no time. Speed Safety Valves deliver the fastest inflation possible. A huge EVA foam body pad on the full nylon cover allows each rider several riding positions. Equipped with dual steering leashes with holsters, a multitude of handles with knuckle guards so you can hold on tight, and custom graphics that will let everyone know you are coming! 966085: 2 rider, 104 in. x 88 in. (deflated) 98 in. x 82 in. (inflated)

PART #	MFG #	U/M	DESCRIPTION		
966084	53-1850	EA	SPORTSSTUFF GRANDSTAND 1	369.99	J
966085	53-1860	EA	SPORTSSTUFF GRANDSTAND 2	599.99	J



WAKE YAK

SPIN, STEER, SLALOM, KAYAK!!

What can't this amazing new DOABLE do? Create your own tricks with multiple spins & slaloms, or explore uncharted waters on this unique ride. With practice you'll learn to spin by rocking back and forth & catching the Tiger Tooth Fins in the water causing the spin cycle to begin. Perform multiple spin moves or slalom back & forth to jump the wake. This DOABLE is packed with features you won't find on any other "normal" towable. Old style towables use a front mounted tow point to pull the tube but DOABLES use an innovative, centrally located VEER Tow System on bottom that allows perfect balance and control to spin, steer, and slalom. Skill Tubing has arrived so finally riders have the amazing ability to control their own ride while the boat simply drives straight. As you gain balance and the ability to maneuver you can spin yourself silly doing multiple spins from 360's to 1080's, you name it. Create your own new tricks and combine various moves to form the ride of your dreams.

Features:

- Patented VEER Towing System
- Low-Profile Unique Kayak Construction
- Patent Pending Tiger Tooth Spinning/Steering Fins
- 7 Foot Double Ended Paddle Included
- Heavy-Duty Full Nylon Cover with Tarpaulin Bottom
- Patented Aluminum Quick Connect Tow Point
- Patented Speed Safety Valve



PART #	MFG #	U/M	DESCRIPTION		
966053	52-3150	EA	SPORTSSTUFF WAKE YAK 2	69.99	J

- accessories
- towables
- body
- controls
- electrical
- driveline
- engine
- fuel & intake
- chemicals
- tie downs
- tools
- towing & loading

MARINE



### CHARIOT WARBIRD 2

#### MULTI ACTION

Prepare for the most advanced action towables in history with the new CHARIOT WARBIRD series from SPORTSSTUFF. Their wide wingspans allow you to challenge even the toughest wake, while remaining some of the most stable rides on the water as their high backrests and multiple handles keep you in place. With a simple switch of the innovative dual tow points the CHARIOT WARBIRDS can be towed in the opposite direction, transforming them into a completely different ride. No matter if you are in the mood for action or relaxation, the CHARIOT WARBIRDS have it all!

#### Features:

- High Visibility Custom Graphics
- Heavy-Duty Full Nylon Cover with Zipper
- Heavy-Gauge PVC Bladders
- High-Back Recumbent Seating
- Aluminum Quick Connect Tow System
- Front and Rear Tow Points for Multiple Riding Positions
- Wide Wing Span Construction Allows for Tight Turns and Stability on the Whips
- Double Webbing Foam Handles
- EVA Foam Knee and Knuckle Guards
- Patented Speed Safety Valve for Fast Inflation and Deflation
- Self Bailing Drain Vents
- 340 LBS. (154 KG) Maximum Weight Capacity



PART #	MFG #	U/M	DESCRIPTION			
966078	53-1780	EA	SPORTSSTUFF CHARIOT WARBIRD 2	459.99	J	

### CHARIOT WARBIRD 3

The CHARIOT WARBIRDS' wide wingspans allow you to challenge even the toughest wake, while remaining one of the most stable rides on the water. Their high backrests with EVA foam seating pads and multiple double webbing foam handles with knuckle guards will keep you in place around every whip and turn. By simply switching the innovative dual tow points the CHARIOT WARBIRDS can be towed in the opposite direction, transforming them into a completely different ride. Inflating, deflating and hook-ups couldn't be faster with Speed Safety Valves and the aluminum Quick Connect. When you are not tubing, the CHARIOT WARBIRD also functions as a deluxe floating lounge so you can kick your feet out and relax. Whether you are in the mood for action or relaxation, these one-of-a-kind towables have you covered!!

1-3 rider, 82 in. x 118 in. (deflated) 79 in. x 110 in. (inflated)



PART #	MFG #	U/M	DESCRIPTION			
966079	53-1790	EA	SPORTSSTUFF CHARIOT WARBIRD 3	559.99	J	

- accessories
- towables
- body
- controls
- electrical
- driveline
- engine
- fuel & intake
- chemicals
- tie downs
- tools
- towing & loading

SPORTSSTUFF  
TOWABLES



- accessories
- towables**
- body
- controls
- electrical
- driveline
- engine
- fuel & intake
- chemicals
- tie downs
- tools
- towing & loading



SLALOM SOLO

Skill Tubing is a challenging new experience, not just another towable that you simply hang on to. The SLALOM SOLO is a new Doable; a controllable towable that you can maneuver, slalom, jump, veer, and do a combination of moves through the boat wake or crest in a straight-line boat pattern. Doables are PATENT PENDING new shapes that have less drag with smaller footprints for reduced gas consumption. A new PATENT PENDING bottom "VEER" tow system, combined with strategically located extra large PATENT PENDING Tiger Tooth Fins enable the rider to control the Slalom Solo in various shoe-lace type moves. Skill is acquired via multiple riding attempts. You will learn that slaloming is achieved by leaning left or right away from the boat. As you gain balance and the ability to maneuver, you will have plenty of spills and chills. All riders, boat drivers and spotters are novices. Start slowly at reduced speeds until you gain confidence, then create your own thrilling ride.

Features:

- Patent Pending VEER Towing System
- Patent Pending Tiger Tooth Spinning/Steering Fins
- PVC Bladder
- Heavy-Duty Full Nylon Cover with Zipper
- Patent Pending Aluminum Quick Connect Tow Point
- Multiple Grab Handles with Knuckle Guards
- Patented Speed Safety Valve for Fast Inflation and Deflation
- 52" x 49"

PART #	MFG #	DESCRIPTION		
966065	53-1398	SPORTSSTUFF SLALOM SOLO	249.99	L

SLALOM JOCKEY

Skill Tubing is a challenging new experience, not just another towable that you simply hang on to. The SLALOM JOCKEY is a new Doable; a controllable towable that you can maneuver, slalom, jump, veer, and do a combination of moves through the boat wake or crest in a straight-line boat pattern. Doables are PATENT PENDING new shapes that have less drag with smaller footprints for reduced gas consumption. A new PATENT PENDING bottom "VEER" tow system, combined with strategically located extra large PATENT PENDING Tiger Tooth Fins enable the rider to control the Slalom Jockey in various shoe-lace type moves. Skill is acquired via multiple riding attempts. You will learn that slaloming is achieved by leaning left or right away from the boat. As you gain balance and the ability to maneuver, you will have plenty of spills and chills. All riders, boat drivers and spotters are novices. Start slowly at reduced speeds until you gain confidence, then create your own thrilling ride.

Features:

- Patent Pending VEER Towing System
- Strategically placed PATENT PENDING Tiger Tooth Steering Fins
- PVC Bladder
- Heavy-Duty Full Nylon Cover with Zipper
- Patent Pending Aluminum Quick Connect Tow Point
- Multiple Grab Handles with Knuckle Guards
- Patented Speed Safety Valve for Fast Inflation and Deflation
- 72" x 49"

PART #	MFG #	DESCRIPTION		
966064	53-1385	SPORTSSTUFF SLALOM JOCKEY	299.99	J



MARINE



## SPORTSSTUFF TOWABLES

### BAT X RAY



#### SKILL TUBING

Skill Tubing is a challenging new experience, not just another towable that you simply hang on to. The BAT-X-RAY PVC is a new Doable; a controllable towable that you can maneuver, slalom, jump, veer, and do a combination of moves through the boat wake or crest in a straight-line boat pattern. Doables are PATENT PENDING new shapes that have less drag with smaller footprints for reduced gas consumption. A new PATENT PENDING bottom "VEER" tow system, combined with strategically located extra large PATENT PENDING Tiger Tooth Fins enable the rider to control the Bat-X-Ray PVC in various shoe-lace type moves. Skill is acquired via multiple riding attempts. You will learn that slaloming is achieved by leaning left or right away from the boat. As you gain balance and the ability to maneuver, you will have plenty of spills and chills. All riders, boat drivers and spotters are novices. Start slowly at reduced speeds until you gain confidence, then create your own thrilling ride.

#### Features:

- PATENT PENDING VEER Towing System
- Strategically placed PATENT PENDING Tiger Tooth Steering Fins
- Special Formula PVC
- Aerodynamic Construction with Fuel Saver Drag-less Design
- Patent Pending Aluminum Quick Connect Tow Point
- Heavy-Duty Molded PVC Handles
- Heavy-Duty Stainless Steel D-ring
- PATENTED Speed Safety Valve for fast Inflation and Deflation

PART #	MFG #	U/M	DESCRIPTION		
966069	53-1510	EA	SPORTSSTUFF BAT X RAY	99.99	J

### BANDWAGON

#### GET ON THE BANDWAGON!

This all-new action towable features a Reduced-drag nose design for effortless towing that virtually eliminates nose-diving at startup. The innovative new seating arrangement allows you to sit forward, backward, kneeling or prone for whatever style of ride you're craving. Now there's room for the whole gang with the all-new BANDWAGON from SPORTSSTUFF!

#### Features:

- High Visibility Custom Graphics
- Exclusive Reduced Drag Nose Design
- Heavy-Duty Full Nylon Cover with Zipper
- Heavy-Gauge PVC Bladders
- High-Back Recumbent Mesh Seating
- Aluminum Quick Connect Tow System
- Custom Sure Grip Handles
- EVA Foam Knee and Knuckle Guards
- Patented Speed Safety Valve for Fast Inflation and Deflation
- Self Bailing Drain Vents



PART #	MFG #	U/M	DESCRIPTION		
966071	53-1620	EA	SPORTSSTUFF BANDWAGON 2+2	629.99	J

accessories

towables

body

controls

electrical

driveline

engine

fuel & intake

chemicals

tie downs

tools

towing & loading

MARINE

## SPORTSSTUFF TOWABLES



accessories

towables

body

controls

electrical

driveline

engine

fuel & intake

chemicals

tie downs

tools

towing & loading

MARINE

### SPEEDZONE 1 • 2 • 3

#### RIDE IN THE ZONE!

Built for speed and dressed for fun. The SpeedZone Three is designed for three riders, providing a stable ride while easily sliding outside the wake for an exhilarating run! This fast track hot rod features a full nylon cover that is as durable as it is sleek, cockpit seating to keep you in the saddle, high backrests, air cushioned floors for a more comfortable ride, and double webbing foam handles to keep your white knuckles from turning red; Speed Zone Three will keep you in the zone!



#### SPEEDZONE 1

##### Features:

- Reinforced tow system
- Custom caution stripe safety graphics
- Padded valve cover
- Speed safety valve for fast, easy inflation/deflation
- Double webbing foam handles with knuckle pads
- Heavy-duty double-stitched full nylon cover
- Heavy-duty PVC bladder
- Air cushioned floor
- Air cushioned backrest
- Inflated Length: 54" Diameter

PART #	MFG #	DESCRIPTION		
966087	53-1920	SPEEDZONE 1	159.99	J



#### SPEEDZONE 2

##### Features:

- Reinforced tow system
- Custom caution stripe safety graphics
- Padded valve cover
- Speed safety valve for fast, easy inflation/deflation
- Double webbing foam handles with knuckle pads
- Heavy-duty double-stitched full nylon cover
- Heavy-duty PVC bladder
- Air cushioned floors
- Air cushioned backrests
- Inflated Length: 80 in
- Inflated Width: 77 in

PART #	MFG #	DESCRIPTION		
966088	53-1931	SPEEDZONE 2	379.99	J



#### SPEEDZONE 3

##### Features:

- Reinforced tow system
- Custom caution stripe safety graphics
- Padded valve cover
- Speed safety valve for fast, easy inflation/deflation
- Double webbing foam handles with knuckle pads
- Heavy-duty double-stitched full nylon cover
- Heavy-duty PVC bladder
- Air cushioned floors
- Air cushioned backrests
- Inflated Length: 100 in Diameter

PART #	MFG #	DESCRIPTION		
966089	53-1940	SPEEDZONE 3	529.99	J

- accessories
- towables**
- body
- controls
- electrical
- driveline
- engine
- fuel & intake
- chemicals
- tie downs
- tools
- towing & loading



## SPORTSSTUFF TOWABLES

### CRAZY 8

Grab a friend and prepare for a wild & crazy tubing experience on the CRAZY 8 for two riders. Dual tow points allow sitting in-line or side-by-side for 2 totally different riding experiences. The unique figure-eight design features a heavy-duty double-stitched partial nylon cover and heavy-duty K80 PVC bladder that's built to last. There are double webbing foam handles with knuckle guards everywhere to accommodate various riding positions. The patented Speed Safety Valve will get your tube inflated and on the water in no time.

2 Rider  
83" x 54" (deflated)  
75" x 48" (inflated)

PART #	MFG #	DESCRIPTION		
966067	53-1450	SPORTSSTUFF CRAZY 8	179.99	J

### OUTLAW

WANTED! REBEL with a CAUSE on this 48" inch, Triangular, 1 person capacity, partially covered tube. Equipped with heavy-duty foam handles intended to increase your comfort on this wild ride! Your mission is to never get caught by the wild, wild wake! Here is your chance to be the "Jesse James" of the water as you ride into the sunset on this popular towable shape. As you move in and out of the wakes on the Outlaw you will now know what it truly means to be a fugitive from the law!



Inflated length:  
52" Triangle

PART #	MFG #	DESCRIPTION		
966056	53-1126	SPORTSSTUFF OUTLAW	89.99	J

MARINE



### SPORTSTUBE

The classic VIP SPORTSTUBE features the patented Speed Safety Valve for fast inflation and deflation, heavy-duty molded PVC handles so you can get a grip, and a heavy-duty molded tow system. Simply inflate your tube, connect the tow rope, and you're off and tubing. The VIP SPORTSTUBE's heavy-duty K80 PVC construction with air cushioned floor makes it easy to ride in the prone or seated position and offers hot action on whips & turns. Size: 1 rider, 54" (deflated) 48" (inflated)

PART #	MFG #	DESCRIPTION		
966055	53-1116	SPORTSSTUFF SPORTSTUBE	59.99	J

**SPORTSSTUFF  
TOWABLES**

**AIR FORCE**

JOIN THE AIRFORCE!

WE WANT YOU to hop on this classic Americana deck tube and join the AIRFORCE! Multiple Double Webbing Foam Handles with Knuckle Guards enable various riding positions and put this tube among the elite. Featuring two EVA Foam Body Pads for extra comfort, the speed and maneuverability of this towable will make you an ace on the water. This solo Flyer features an Aluminum Quick Connect Tow Point to make attaching and detaching your tow rope quick and easy & also comes equipped with the patented Speed Safety Valve for the fastest inflation and deflation possible. Enlist today and feel the excitement of the Air Force Flyer Deck Tube!

**Features:**

- Classic Deck Tube Design
- Heavy-Duty Full Nylon Cover with Zipper
- Heavy-Gauge PVC Bladder
- Patented Aluminum Quick Connect Tow Point
- Patented Speed Safety Valve
- Double Webbing Foam Handles with Knuckle Guards
- 2 EVA Foam Body Pads for maximum comfort
- Custom Americana Graphics on top & bottom
- 60"

PART #	MFG #	DESCRIPTION		
966072	53-1646	AIR FORCE	149.99	J



**STUNT FLYER**

**DAREDEVIL DECK TUBE**

Lay down, hold on, and let the Stunt Flyer take you and a friend for a ride! This large flat deck tube for 1-2 riders has multiple Double Webbing Foam Handles with Knuckle Guards to enable various riding positions and two EVA Foam Body Pads for extra comfort. Your stunt team will fly across the water through whips and turns on this nitro-packed deck towable. Featuring an Aluminum Quick Connect Tow Point, attaching and detaching your tow rope is made fast and easy so you can maximize your time on the water. The Stunt Flyer also comes equipped with the patented Speed Safety Valve for the fastest inflation and deflation possible with an inflatable towable. New custom daredevil graphics on the top and bottom of this classic deck tube will keep you and a friend riding in style all summer long.

**Features:**

- Classic Deck Tube Design
- Heavy-Duty Full Nylon Cover with Zipper
- Heavy-Gauge PVC Bladder
- Patented Aluminum Quick Connect Tow Point
- Patented Speed Safety Valve
- Double Webbing Foam Handles with Knuckle Guards
- 2 EVA Foam Body Pads for maximum comfort
- Custom Dare-Devil Graphics on top & bottom
- 70"

PART #	MFG #	DESCRIPTION		
966073	53-1651	STUNT FLYER	199.99	J



- accessories
- towables**
- body
- controls
- electrical
- driveline
- engine
- fuel & intake
- chemicals
- tie downs
- tools
- towing & loading

MARINE

## SPORTSSTUFF TOWABLES

### FREQUENT FLYER

#### FREQUENT FUN!

Grab your friends, jump on board the Frequent Flyer, and get ready for action! This huge flat deck towable for 1-3 riders has multiple Double Webbing Foam Handles with Knuckle Guards to enable various riding positions and two EVA Foam Body Pads for extra comfort. Rocket across the wake and skim around whips and turns over and over again on this classic re-designed deck tube from Sportsstuff. Featuring an Aluminum Quick Connect Tow Point to make attaching and detaching your tow rope quick and easy, the Frequent Flyer also comes equipped with the patented Speed Safety Valve for the fastest inflation and deflation possible. New sleek custom graphics on the top and bottom of this classic deck towable will keep you and your friends coming back for more.

#### Features:

- Classic Deck Tube Design
- Heavy-Duty Full Nylon Cover with Zipper
- Heavy-Gauge PVC Bladder
- Patented Aluminum Quick Connect Tow Point
- Patented Speed Safety Valve
- Double Webbing Foam Handles with Knuckle Guards
- 2 EVA Foam Body Pads for maximum comfort
- Sleek Custom Graphics on top & bottom
- 80"

PART #	MFG #	DESCRIPTION		
966074	53-1661	FREQUENT FLYER	259.99	J



### WET N' WILD FLYER

#### AS BIG AS THEY GET!

Once you've taken a ride on this amazing tube, you'll know why we name it WET N' WILD! This mammoth flat deck towable for 1-4 riders has multiple Double Webbing Foam Handles with Knuckle Guards to enable various riding positions and two EVA Foam Body Pads for extra comfort. Up to 4 riders can experience the excitement of the biggest and baddest deck tube available. Featuring an Aluminum Quick Connect Tow Point, attaching and detaching your towrope is made fast and easy so you can maximize your time on the water. The Wet N' Wild Flyer also comes equipped with the patented Speed Safety Valve for the fastest inflation and deflation possible. You and your friends will fly around every whip and turn with unbelievable speed and grace on this amazing re-designed deck tube from Sportsstuff. New stylish custom graphics on the top and bottom of this classic deck tube will continue to make it a "Must Have" towable for years to come.

#### Features:

- Classic Deck Tube Design
- Heavy-Duty Full Nylon Cover with Zipper
- Heavy-Gauge PVC Bladder
- Patented Aluminum Quick Connect Tow Point
- Patented Speed Safety Valve
- Double Webbing Foam Handles with Knuckle Guards
- 2 EVA Foam Body Pads for maximum comfort
- Stylish Custom Graphics on top & bottom
- 96"



PART #	MFG #	DESCRIPTION		
966075	53-1671	WET-N-WILD FLYER	379.99	J

- accessories
- towables
- body
- controls
- electrical
- driveline
- engine
- fuel & intake
- chemicals
- tie downs
- tools
- towing & loading



## SPORTSSTUFF TOWABLES

### BIG BERTHA

Get ready for big fun with the all new BIG BERTHA! This giant 4 person classic action towable is updated with state of the art features such as a new air cushioned floor, non slip cushioned handles with padded knuckle guards, and a fast and easy Quick Connect tow system. Just slip your tow rope over the Quick Connect and you're off and tubing. The BIG BERTHA is built heavy duty and is fully loaded. Grab the gang and create your own riding experience. Ride with 2, 3, or even 4 of your friends, or you can try tackling this monster by yourself. Hit the lake this summer with the all new smooth riding BIG BERTHA!

#### Features:

- Heavy-Duty Partial Nylon Cover
- Heavy-Gauge PVC Bladder with Air Cushioned Inflated Floor
- Quick Connect Tow System
- Non Slip Cushioned Handles with Foam Padded Knuckle Guards and Reflective Safety Piping
- Speed Safety Valve
- 4 Rider Maximum Capacity
- 680 lbs. (308 KG) Max Capacity
- 74"

PART #	MFG #	DESCRIPTION		
966063	53-1329	BIG BERTHA	189.99	J



### ZIP SKI

**MAKE WAVES** Get ready to take on the wake with the smooth riding ZIP SKI MY-T TUBE! This classic action towable is updated with a fast easy quick connect tow system. Just slip your tow rope over the Quick Connect and you're off and tubing. The ZIP SKI is fully loaded with double webbing foam handles and EVA foam knuckle guards so you can hold on tight. The ZIP SKI is easy to control in the prone and seated positions while still offering up some hot action on the whips. Take a ride with the ZIP SKI and become a MY-T TUBER this summer. - Heavy-Duty Partial Nylon Cover - Heavy-Gauge PVC Bladder - Double Webbing Foam Handles - EVA Foam Knuckle Pads - Speed Safety Valve for fast easy inflation and deflation - 1 Rider Maximum Capacity - 170 lbs. (77KG) Max Capacity - Aluminum Quick Connect Tow System. 54".

Specifications:

- Inflated Length: 48" Diameter

PART #	MFG #	DESCRIPTION		
966061	53-1313	ZIP SKI	89.99	J

### RASCAL

Round and ready for action. Compact size is easy to handle and makes this tube versatile for riders of all recommended ages!

#### Features:

- Double-Webbing Foam Handles with Knuckle Pads
- Double-Stitched Partial Nylon Cover
- P.U. Fabric Coating
- Tow Rope Holster
- Heavy-Gauge PVC Bladder
- 2 Chambers (main & safety)
- Self Bailing Drain Vent
- Reinforced Tow System
- 63"

Specifications:

- Inflated Length: 56" Diameter

PART #	MFG #	DESCRIPTION		
966062	53-1320	RASCAL	129.99	J



- accessories
- towables
- body
- controls
- electrical
- driveline
- engine
- fuel & intake
- chemicals
- tie downs
- tools
- towing & loading



## SPORTSSTUFF TOWABLES

### NOODLER™ 1 & 2



Relax with the NOODLER Lounges, available in 1 and 2 person sizes. Cool off, kick back and enjoy the comfortable mesh seating. Slip your favorite cool beverage into the built in drink holder. Flip the NOODLERs over and have a custom belly board to splash up some fun with! Heavy-duty K80 PVC construction with patented Speed Safety Valve allows you to inflate or deflate them quickly and easily. If you want relaxation at the pool, beach, or lake this summer then the Sportsstuff NOODLER Lounges are your ticket to serenity.

966114: 1 person, 33 in. X 44 in. (deflated) 32 in. x 42 in. (inflated)

966115: 1-2 person, 55 in X 77 in (deflated) 54 in. X 71 in. (inflated)

PART #	MFG #	DESCRIPTION		
966114	54-1851	NOODLER 1	29.99	J
966115	54-1852	NOODLER 2	47.99	J



### CANTINA LOUNGE

There's always a party in the pool or lake with CANTINA LOUNGE! It features comfortable cool mesh seating with great back support for 1 to 4 people. Four molded cup holders keep drinks close at hand. The large recessed area in the center conveniently holds sundries or ice and drinks. Constructed of heavy gauge PVC. Size: 86" x 60" (deflated).



PART #	MFG #	DESCRIPTION		
966663	54-2025	CANTINA LOUNGE	119.99	J

- accessories
- towables
- body
- controls
- electrical
- driveline
- engine
- fuel & intake
- chemicals
- tie downs
- tools
- towing & loading

**SPORTSSTUFF  
LOUNGE & LEISURE**



**SIESTA LOUNGE™**

Take a snooze or find your place in the sun on the SIESTA LOUNGE! Features a high back air cushioned headrest and comfortable mesh seating you won't believe. Hang your feet in the water to cool off, or put them up on the fold out footrest for complete relaxation! Includes molded cup holders for two of your favorite beverages, and two convenient zippered storage pockets with plenty of room for your suntan lotion and other necessities. The SIESTA has a full nylon cover, heavy-duty K80 PVC bladders, and a patented Speed Safety Valve for fast and easy inflation so you can chill out.

Size: 1 person, 67" x 40" (deflated) 68" x 40" (inflated)

PART #	MFG #	DESCRIPTION		
966110	54-1602	SIESTA LOUNGE	114.99	J



- accessories
- towables**
- body
- controls
- electrical
- driveline
- engine
- fuel & intake
- chemicals
- tie downs
- tools
- towing & loading

**TREK N TUBE**

Kick back and relax in style with the Sportsstuff Trek-N-Tube lounge. The Trek-N-Tube includes its very own travel backpack making it portable to the pool, lake, or river. Take a seat and experience relaxation with the Trek-N-Tube's many features including cool comfort mesh seating, 2 built-in 6 pack coolers for your favorite refreshing beverages, and 2 gear pockets for your sun tan lotion and other necessities. The Trek-N-Tube is loaded and ready to explore.

- Features:**
- Heavy-Duty Full Nylon Cover
  - Heavy-Gauge PVC Bladder
  - High Backrest Seating
  - 2 Built-In 6 Pack Zippered Coolers
  - 2 Built-In Cup Holders
  - 2 Gear Pockets
  - Cool and Relaxing Comfort Mesh Seating
  - Tote Handles for Easy Portability
  - Travel Backpack for Easy Portability
  - Designed for Lake, River Tubing, and Pool Lounging
  - Speed Safety Valve for Fast Inflation and Deflation
  - 200 LBS. (90 KG) Max Capacity
  - Inflated Height: 21 in
  - Inflated Length: 48 in Diameter



PART #	MFG #	DESCRIPTION		
966052	52-1501	TREK N TUBE	104.99	J

MARINE



## SPORTSSTUFF LOUNGE & LEISURE

### ROCK & ROLL LOUNGE™



Lean back and relax in the unique ROCK & ROLL LOUNGE. It's contoured for comfort and floats on the water's surface like a fine piece of art. The sleek and sexy ergonomic design is both fashionable and functional, so you can lounge in multiple positions within the seating area to achieve maximum comfort. The ROCK AND ROLL LOUNGE comes equipped with the patented Speed Safety Valve so you can

inflate the lounge in no time and start relaxing. This one-of-a-kind lounge is your ticket to high class comfort whether on land or water.  
Size: 1 person, 61 in. x 55 in. (deflated) 57 in. x 51 in. (inflated)

PART #	MFG #	DESCRIPTION	
966113	54-1680	ROCK & ROLL LOUNGE	119.99 J

### POOL & BEACH 2UP LOUNGE



Link 2, 3 or 4 POOL N' BEACH 2 UP Lounges together and have a floating party! This 2 person designer lounge is built for comfort, with 2 mesh seats and air filled headrests. The fashionable striped "creamsicle" design will look great in any pool. It's equipped with integrated connectors to link 2 or more together, 2 molded drink holders and a rope holder for tethering in lakes. The thick, durable 20 gauge K80 construction ensures long service. Equipped with a Speed Safety Valve for fast and easy inflating and deflating. Size: 1-2 person, 48 in. x 77 in. (deflated) 44 in. x 73 in. (inflated)

PART #	MFG #	DESCRIPTION	
966119	54-1982	POOL & BEACH 2 UP LOUNGE	69.99 J

- accessories
- towables
- body
- controls
- electrical
- driveline
- engine
- fuel & intake
- chemicals
- tie downs
- tools
- towing & loading

MARINE

**SPORTSSTUFF  
LOUNGE & LEISURE**



**NEPTUNE ISLAND**

NEPTUNE ISLAND seats from 1-6 persons and makes for the perfect floating lounge for social interaction. There are 3 built in coolers with six molded PVC cup holders and a comfortable reinforced mesh bottom surface to keep you cool while you're relaxing. Sit on the floating platform portion and let your toes go for a dip. Features K80 PVC construction, and a Speed Safety Valve for inflating and deflating ease.

**Features:**

- 3 Six-Pack Coolers
- Central Mesh Opening
- Molded Cup Holder's
- Anchor System
- Molded Handles
- Grommets
- 3 Boarding Platforms



PART #	MFG #	DESCRIPTION	
968077	54-2030	NEPTUNE ISLAND	449.99 J

- accessories
- towables**
- body
- controls
- electrical
- driveline
- engine
- fuel & intake
- chemicals
- tie downs
- tools
- towing & loading

**CABANA ISLANDER™  
WITH 16 QUART FLOATING  
COOLER**

Relax on the CABANA ISLANDER, a one-of-a-kind island for up to 6 people to enjoy. Constructed of heavy-duty K80 PVC with a detachable wind-resistant nylon cabana top to keep you in the shade. Speed Safety Valves deliver the fastest inflation and deflation possible and the anchor system will keep you from floating away. Also includes a center swim porthole, boarding platform for easy access, and a floating 16 QUART COOLER that can be tethered to the island. 16 QUART COOLER includes zippered lid, cup holders, rope grommet, and molded handle. Size: 1-6 person, 108 in. x 82 in. (deflated) 102 in. x 76 in. (inflated)



PART #	MFG #	DESCRIPTION	
966118	54-1920A	CABANA ISLANDER	499.99 J

**MARINE**



## SPORTSSTUFF LOUNGE & LEISURE

### POOL N' BEACH 6UP LOUNGE™

Sit back and relax on the POOL N' BEACH 6UP LOUNGE. Up to 6 people can simultaneously enjoy the air cushioned headrests and backrests and the comfortable mesh seating! Molded PVC cup holders all around will hold your favorite beverages and the included anchor bag will keep you from floating away. Made of heavy-duty K80 PVC, the unique round face-to-face design puts everyone in the center of the action. There's even an open pool in the middle to dip your toes in! Features patented Speed Safety Valves and a grommet system for attaching a floating cooler. Size: 1-6 person, 122 in. x 122 in. (deflated) 116 in. x 116 in. (inflated)



PART #	MFG #	DESCRIPTION	
966120	54-1985	POOL & BEACH 6 UP LOUNGE	319.99 J

### SPORTSSTUFF® FIESTA ISLAND™ WITH 16 QUART FLOATING COOLER

FIESTA PRIVATE ISLAND has room for 8 people with molded PVC cup holders all around and a comfortable mesh bottom surface to keep you cool while you're relaxing. Sit on the mesh to enjoy the contoured backrests in the water, or sit on the floating platform portion and just let your toes go for a dip. Features heavy-duty K80 PVC construction, the Speed Safety Valve, anchor system so you don't float away, and molded handles for easy transporting. Tie the floating 16 QUART COOLER (included) with molded cup holders to the island's grommet system. Size: 1-8 person, 11.5 ft. x 11.5 ft. (deflated) 11.5 ft. x 11.5 ft. (inflated)



PART #	MFG #	DESCRIPTION	
966121	54-2010	FIESTA ISLAND	579.99 G

- accessories
- towables
- body
- controls
- electrical
- driveline
- engine
- fuel & intake
- chemicals
- tie downs
- tools
- towing & loading

MARINE

**SPORTSSTUFF  
LOUNGE & LEISURE**



- accessories
- towables**
- body
- controls
- electrical
- driveline
- engine
- fuel & intake
- chemicals
- tie downs
- tools
- towing & loading

**BANANA BEACH LOUNGE**

Add some luxury to your pool, lake or beach experience with BANANA BEACH Lounge. It's even more comfortable than it looks! Lounge in style with a cool drink sitting in the molded cup holder. If you're on a lake, be sure to tether it to a moored boat, dock or a friend's BANANA BEACH with the molded rope holder, because you will fall asleep! Featuring a sleek ergonomic backrest and thick, durable 20 gauge K80 construction. Equipped with a Speed Safety Valve for easy inflating and deflating.  
Size: 1 person, 77 in. x 43 in. (deflated) 75 in. x 42 in. (inflated)



PART #	MFG #	DESCRIPTION	
966112	54-1660	BANANA BEACH LOUNGE	69.99 J

**16 QUART & 60 QUART  
FLOATING COOLER**

Take your party to the water with these large capacity FLOATING COOLERS filled with your favorite beverages! Featuring 4 molded cup holders, an easy access zippered lid, molded handle for transporting, & a grommet for easy tie-offs. Constructed of heavy-duty K80 PVC & equipped with Safety Valves for fast & easy inflation. Relax with the drink of your choice as you float along the water with a FLOATING COOLER trailing behind you!

966618: 12 (12oz.) can capacity, 34" (deflated) 30" (inflated)  
966051: 48 (12oz.) can capacity, 40" (deflated) 36" (inflated)



PART #	MFG #	DESCRIPTION	
966618	40-1003	16 Quart Floating Cooler	49.99 J
966051	40-1010	60 Quart Floating Cooler	59.99 J



**COOLER CADDY**

With Sportsstuff's Cooler Caddy, your cooler and its contents can accompany you into a pool, lake or river. Your refreshments will be bobbing with you and your friends, no need to go on land to get a cold drink! Four cup holders keep drinks handy. Tether it to a dock or boat with the convenient molded tether points. It's equipped with a patented Speed Safety Valve for quick inflation and deflation and a self draining bottom. Fits up to 48 quart (45 liter) coolers with dimensions up to 28 in. long x 17 in. wide.  
Size: 47" x 38" deflated.

PART #	MFG #	DESCRIPTION	
966664	40-1020	COOLER CADDY	21.99 J

MARINE



## SPORTSSTUFF LOUNGE & LEISURE

### PVC TRAMPOLINE



**BIG JUMP!** Available in 10 and 12ft. sizes, these are giants! Inflation is easy with its single chamber design, and the attachable boarding platform makes it a cinch to climb on board from the water! The included sea-anchor system keeps the trampoline stable as you bounce and lounge on this larger than life inflatable. Big time fun is yours!

**Features:**

- Large bouncing surface
- Heavy-gauge PVC bladder
- Molded handles
- Inflated Length: **966129** - 10 foot (300 cm) diameter, **966130** - 12 foot (365 cm) diameter
- Inflated Height: **966129** - 30 in, **966130** - 36 in



PART #	MFG #	DESCRIPTION		
<b>966129</b>	58-1015	10' FUNSTATION	<b>529.99</b>	J
<b>966130</b>	58-1035	12' FUNSTATION	<b>769.99</b>	J

### SPILLWAY PONTOON SLIDE

SPORTSSTUFF SPILLWAY will provide years of fun for the kiddos! Inflate and attach to your pontoon in 5 minutes or less, then watch the fun start on the 8 foot long sliding surface! The raised inflatable safety chambers on both sides safely keep sliders centered. Four inset molded steps and two molded handles make it easy to climb onto. Constructed of heavy duty UV treated 1,000 denier polyester reinforced PVC to ensure long service. Seams are hot air overlap welded to increase durability. Capacity: 1 user, 200 lbs., 10.5' x 33" x 54" (inflated)

PART #	MFG #	DESCRIPTION		
<b>966472</b>	58-1350	Spillway Pontoon Slide	<b>599.99</b>	D



- accessories
- towables
- body
- controls
- electrical
- driveline
- engine
- fuel & intake
- chemicals
- tie downs
- tools
- towing & loading



## SPORTSSTUFF ROPES



### 2K TOW ROPE

2375-pound (1.08 Mg) break strength! This rope is perfect for towing all Sportsstuff 1 and 2-rider tubes. Features a molded plastic caddy for easy storage. 60 Feet (18.3 meter) length.

**Features:**

- Molded Plastic Caddy
- 2375 Pound (1.08 Mg) Break Strength
- Minimum Stretch Design

PART #	MFG #	U/M	DESCRIPTION		
966625	57-1522	EA	SPORTSSTUFF 2K Rope	18.99	J

### 4K TOW ROPE

4100-pound (1.86 Mg) break strength! This heavy-duty rope is perfect for towing any tube with up to 4 riders. Features a molded plastic caddy for easy storage. 60 Feet (18.3 meter) length.

**Features:**

- Molded Plastic Caddy
- 4100 Pound (1.86 Mg) Break Strength
- Minimum Stretch Design



PART #	MFG #	U/M	DESCRIPTION		
966126	57-1532	EA	SPORTSSTUFF 4K Rope	25.99	J

### 6K TOW ROPE

6100-pound (2.77 Mg) break strength! This heavy-duty rope is for towing any tube with up to 6 riders. Features a molded plastic caddy for easy storage. 60 Feet (18.3 meter) length.

**Features:**

- Molded Plastic Caddy
- 6100 Pound (2.77 Mg) Break Strength
- Minimum Stretch Design



PART #	MFG #	U/M	DESCRIPTION		
966127	57-1542	EA	SPORTSSTUFF 6K Rope	34.99	J



### 4K QUICK CONNECTOR

The 4K Quick Connector makes it easy to attach and detach tow ropes to towables. Simply attach the connector to the towable tow strap instead of having to thread a long tow rope through the strap. This heavy-duty connector is perfect for towing up to 4 riders on any tube with or without a Quick Connector.

**Features:**

- 4100 Pound (1.86Mg) Break Strength
- Aluminum Quick Connect Tow Point (PATENT# 564,869)
- 12 Inch Length
- Minimum Stretch Design

PART #	MFG #	U/M	DESCRIPTION		
966128	57-1655	EA	SPORTSSTUFF Quick Connector	13.99	J

### WATERSPORTS GLOVES



**GREAT FOR TUBING**

Fingerless towable gloves with padded palm patch allow riders to achieve a secure grip, while helping to alleviate muscle fatigue, blisters, and callouses. Constructed with neoprene, so they are lightweight, soft, and flexible. One size fits most riders.

PART #	MFG #	U/M	DESCRIPTION		
966131	60-3000	PR	SPORTSSTUFF Watersports Gloves	20.99	J

- accessories
- towables
- body
- controls
- electrical
- driveline
- engine
- fuel & intake
- chemicals
- tie downs
- tools
- towing & loading

MARINE

- accessories
- towables
- body
- controls
- electrical
- driveline
- engine
- fuel & intake
- chemicals
- tie downs
- tools
- towing & loading



## 2.5 PSI PUMP

This 110-volt pump will inflate or deflate your inflatable in a hurry. It comes with an assortment of nozzles to adapt to your needs and has a high-volume, low-pressure output to get the job done quickly.

PART #	MFG #	U/M	DESCRIPTION		
966124	57-1509	EA	SPORTSSTUFF 2.5 PSI Electric Pump	45.99	J

## SPORTSSTUFF AIR PUMPS



## LP1 HAND PUMP

This lightweight plastic pump is designed to inflate/deflate inflatables with less effort due to its continuous stream of output on both the up and down strokes. This pump easily doubles as a handy bilge and can also deflate. Besides using to fill an item completely, we also recommend using this pump to top off your items after inflated with a 12v electric pump. It is also handy to keep on the boat for topping off your tubes while on the water.

### Features:

- 2.0 Liters Per Stroke Output
- Inflate/Deflate
- Interlocking Nozzles
- Bilge Capability
- Sturdy Construction

PART #	MFG #	U/M	DESCRIPTION		
966122	57-1004	EA	SPORTSSTUFF LP 1 Hand Pump	21.99	L



## COMPRESSOR ADAPTER

The Compressor Adapter allows you to inflate or top off your tube using a standard bicycle tire pump or air compressor. The Compressor Adapter only fits on the screw-on type valves like the 'boston' valve (aka 'speed valve') or multi-valve. The Compressor Adapter is not for use on push-in style valves like the Speed Safety valve, over-sized safety valve, or safety valve. Consult your product user manual to see what kind of valve your product uses.



PART #	MFG #	U/M	DESCRIPTION		
966033	10-1010	EA	SPORTSSTUFF Compressor Adapter	5.99	J

## PVC REPAIR

Repair your favorite PVC products that you thought could no longer be used with Sportsstuff PVC REPAIR ADHESIVE & SEALANT. This amazing product has the ability to fix those pesky leaks saving you money so you can get back out on the water again. It's extremely affordable and easy to use (not for fabric or nylon covers.) Simply follow the basic instructions that come with the product and you'll be off and tubing again.



PART #	MFG #	U/M	DESCRIPTION		
966032	10-1001	EA	SPORTSSTUFF PVC Adhesive	5.99	L

## WORLD INDUSTRIES

### DEVIL'S CREST WAKEBOARD

Our top of the line 141cm World Industries wakeboard, DEVIL'S CREST has a 6 fin dual thruster setup that provides the ultimate in hold and tracking. Riders stay on edge, get more speed into the wake and stomp landings without slipping out. The removable center fins provide tracking. The side fins are curved and angle outwards at 11 degrees to provide extra edge hold and a loose feel in neutral. The continuous rocker is fast and forgiving with smooth pop. It's a great board for intermediate to expert riders weighing 150 lbs. and up.

PART #	MFG #		
966601	WIW-5010	200.00	L

### CHECKS WAKEBOARD

Flameboy is "Still Raisin Hell" with a little pyromania on this board! CHECKS is designed for riders looking for smooth transition through turns and a consistent pop off the wake. The rounded end profile and beveled perimeter provide a forgiving and consistent release off the wake. Riders of all levels will enjoy the floaty nature of this 135cm free-ride wakeboard. Designed for riders up to 170 lbs., 2 removable fiberglass reinforced nylon fins provide excellent tracking.

PART #	MFG #		
966585	WIW-2	189.99	L





**BODY**



- accessories
- towables
- body**
- controls
- electrical
- driveline
- engine
- fuel & intake
- chemicals
- tie downs
- tools
- towing & loading

## VISION 180 MIRROR W/DELUXE CAST ALUMINUM MOUNTING BRACKET

Large 18 5/8" x 5 5/8" Convex Mirror provides full 180 range of port to starboard rearview vision. Cup mount with tightening knob works perfectly with Deluxe Windshield Mirror Bracket (02310) Black Cup Mount and (02320) Silver Cup Mount. Sold as Single.

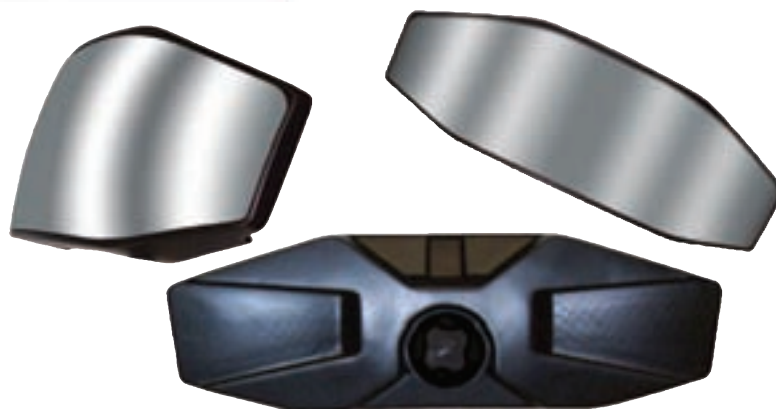

COLOR	MFG #	PART #	
Black	01609	530042	228.95 B

## WAVE MIRROR W/DELUXE CAST ALUMINUM MOUNTING BRACKET

CIPA's Wave Mirror is a 7 x 17 inch marine mirror with OE grade convex shatterproof safety glass. In order for glass to be considered of OE grade it must utilize a technique called first surface coating. First surface coating provides a high quality image that eliminates symptoms such as ghosting and multiple reflections. The Wave Mirror has a totally new styling that provides for a better look and better performance. It features an increased overall viewing size for better functionality. The large mirror face combined with the convex design provides for wide angle viewing that is perfect for wakeboarding. The lightweight design of the mirror head minimizes vibration and bracket wear. The anti-scratch bracket accommodates square windshield frames from 0.375 inches to 1 inch thick. Once mounted, the Wave Mirror will sit about 3 inches above the windshield frame. The bracket is made from aluminum and has a black textured finish. It features quick and easy clamp-on mounting, which means no holes to drill. Mirror head exceeds Alabama's 78 square inch law.

### Product Features:

- 7 x 17 inch marine mirror with OE grade convex shatterproof safety glass that provides a high quality image without symptoms such as ghosting and multiple reflections
- Totally new styling that provides for a better look and better performance
- Large mirror face combined with a convex design provides for wide angle viewing that is perfect for wakeboarding
- Lightweight mirror head minimizes vibration and bracket wear. Aluminum anti-scratch bracket accommodates square windshield frames from 0.375 inches to 1 inch thick
- Features quick and easy clamp-on mounting, which means no holes to drill



COLOR	MFG #	PART #	
Black	01409	530043	174.95 B

## COMP MIRROR W/DELUXE CAST ALUMINUM MOUNTING BRACKET

CIPA's COMP Marine Mirror offers approximately 98 square inches of rear view vision for the ultimate in boating safety. This exceeds Alabama's 78 square inch law by 20 square inches offering a wide angle view. The COMP Marine Mirror is perfect for competitive water sports and is considered a tournament standard in safety. The mirror head features OE grade shatterproof convex safety glass, and meets QS9000 and ISO 9002 standards. In order for glass to be considered of OE grade it must utilize a technique called first surface coating. First surface coating provides a high quality image that eliminates symptoms such as ghosting and multiple reflections. The result is a crisp clear view. The COMP Marine Mirror can be mounted to round windshield frames from 0.375 to 1 inch in diameter. Once mounted, it will sit approximately 3 inches above the windshield. The attached mounting bracket is made from aluminum and has a black textured finish. It attaches to the windshield using a quick and easy clamp-on design. This mirror is also available for boats with square windshield frames that are 0.375 to 1 inch thick part number 01875 (M1B875).

### Product Features:

- Offers approximately 98 square inches of rear view vision for the ultimate in boating safety
- Perfect for competitive water sports and is considered a tournament standard in safety
- Mounts to round windshield frames from 0.375 to 1 inch in diameter
- Durable aluminum bracket attaches using a quick and easy clamp-on design
- Features OE grade shatterproof convex safety glass, and meets QS9000 and ISO 9002 standards



COLOR	MFG #	PART #	
Black	01309	530044	176.95 B



## COMP UNIVERSAL MARINE MIRROR

### W/DELUXE CAST ALUMINUM MOUNTING BRACKET

CIPA's COMP Universal Marine Mirror was designed with competition water skiing in mind. With a 7 x 14 inch convex mirror face, the captain is sure to see the skier perform all of the tricks, and of course, all of the wipe outs too. The COMP Universal Marine Mirror features a ball and socket tension adjustment knob to keep the mirror where it's positioned. The universal bracket will mount to rectangular or rounded windshield frames from 0.375 to 1.25 inches thick. When it comes to water sports, being safe is just as important as having fun.

**Product Features:**

- 7 x 14 inch mirror head
- Meets the Alabama 78 sq. inch law
- Universal mount for round or square windshields
- Ball and socket tension adjustment knob keeps it where you position it
- Fits windshield frames from 0.375 to 1.25 inches thick

COLOR	MFG #	PART #
Black	02109	530045 184.95 B



## EXTREME MIRROR W/DELUXE CAST ALUMINUM MOUNTING BRACKET

CIPA's Extreme Marine Mirror is the first ever multi-lens marine mirror designed exclusively for ski boats. This mirror features a 12 x 6 inch shatterproof convex center lens, and two adjustable 4 x 6 inch shatterproof flat lenses on each end. The overall size of the mirror measures 7 x 20 inches providing an excellent wide angle view of the rear and sides of the boat. The Extreme Marine Mirror features a ball and socket adjustment knob that will keep the mirror where you position it. The universal anti-scratch bracket mounts to rectangular or round windshield frames from 0.375 to 1.25 inches. The attached mounting bracket is made from aluminum and has a black textured finish. It attaches to the windshield using a quick and easy clamp-on design and can be positioned to sit above or below the windshield frame. The Extreme Marine Mirror is constructed of heavy-duty durability tested materials and features OE grade glass. In order for glass meet OE standards it must be made utilizing a technique called first surface coating. First surface coating provides a high quality image that eliminates symptoms such as ghosting and multiple reflections. OE standards ensure high quality and a crisp clear view. This mirror easily exceeds Alabama's 78 square inch law.

**Product Features:**

- First ever multi-lens marine mirror designed exclusively for ski boats easily exceeding the 78 square inch law of Alabama
- Features a 12 x 6 inch shatterproof convex center lens, and two adjustable 4 x 6 inch shatterproof flat lenses on each end. The overall size of the mirror measures 7 x 20 inches providing an excellent wide angle view of the rear and sides of the boat
- Features a ball and socket adjustment knob that will keep the mirror where you position it
- Universal anti-scratch aluminum bracket mounts to rectangular or round windshield frames from 0.375 to 1.25 inches. Uses a quick and easy clamp-on design and can be positioned to sit above or below the windshield frame
- High quality mirror constructed of heavy-duty durability tested materials and OE grade glass

COLOR	MFG #	PART #
Black	02129	530046 215.95 B



## CONCEPT II MIRROR W/HIGH STRENGTH COMPOSITE BRACKET

CIPA's Concept II Marine Mirror features a 4 x 8 inch OE grade shatterproof convex safety glass mirror surface to provide added safety and situational awareness. In order for glass to be considered of OE grade it must utilize a technique called first surface coating. First surface coating provides a high quality image that eliminates symptoms such as ghosting and multiple reflections. The convex design of the glass provides for a wider viewing angle. The Concept II Marine Mirror is universal in application and fit, and mounted above or below the windshield. Ball and socket tension adjustment knob design keeps the mirror where it's positioned. The aluminum anti-scratch quick-mount bracket accommodates round or square windshield frames from 1/2 to 7/8 of an inch. Made with non-corrosive materials and salt spray tested. Easy to install. All hardware included.

**Product Features:**

- Features a 4 x 8 inch OE grade shatterproof convex safety glass mirror surface to provide added safety and situational awareness
- Universal in application and fit, and mounted above or below the windshield. Ball and socket tension adjustment knob design keeps the mirror where it's positioned
- Convex glass design provides for a wider viewing angle
- Aluminum anti-scratch quick-mount bracket accommodates round or square windshield frames from 1/2 to 7/8 of an inch
- Made with non-corrosive materials and salt spray tested. Easy to install. All hardware included

COLOR	MFG #	PART #
Black	11073	530047 48.95 B



- accessories
- towables
- body**
- controls
- electrical
- driveline
- engine
- fuel & intake
- chemicals
- tie downs
- tools
- towing & loading

**MARINE**



- accessories
- towables
- body**
- controls
- electrical
- driveline
- engine
- fuel & intake
- chemicals
- tie downs
- tools
- towing & loading

## COMP II MIRROR w/HIGH STRENGTH COMPOSITE BRACKET

CIPA's COMP II Marine Mirror features a 4 x 11 inch OE grade shatterproof convex safety glass mirror surface to provide added safety and situational awareness. In order for glass to be considered of OE grade it must utilize a technique called first surface coating. First surface coating provides a high quality image that eliminates symptoms such as ghosting and multiple reflections. The convex design of the glass provides for a wider viewing angle. The COMP II Marine Mirror is universal in application and fit, and can be mounted above or below the windshield. Ball and socket tension adjustment knob design keeps the mirror where it's positioned. The aluminum anti-scratch quick-mount bracket accommodates round or square windshield frames from 1/2 to 7/8 of an inch. Made with non-corrosive materials and salt spray tested. Easy to install. All hardware included.

### Product Features:

- Features a 4 x 11 inch OE grade shatterproof convex safety glass mirror surface to provide added safety and situational awareness
- Universal in application and fit, and mounted above or below the windshield. Ball and socket tension adjustment knob design keeps the mirror where it's positioned
- Convex glass design provides for a wider viewing angle
- Aluminum anti-scratch quick-mount bracket accommodates round or square windshield frames from 1/2 to 7/8 of an inch
- Made with non-corrosive materials and salt spray tested. Easy to install. All hardware included



COLOR	MFG #	PART #	
Black	11083	530048	55.95 B

## ELLIPSE MIRROR w/HIGH STRENGTH COMPOSITE BRACKET

CIPA's Ellipse Marine Mirror is a 4 x 11 inch multi-lens universal boating mirror. It features one 3.25 x 6 inch convex stationary lens in the center and two adjustable 2.5 x 2.5 inch flat lenses on each side. It is great for boats with walkthrough windshields because it allows you to position the outer lenses so that you can avoid mounting the mirror to the center of the windshield. A ball and socket tension knob keeps the mirror where you position it. The universal quick-mount, anti-scratch bracket will mount to rectangular or rounded windshield frames from 15/32 to 1-3/16 of an inch. The attached mounting bracket is made from aluminum and has a black textured finish. It attaches to the windshield using a quick and easy clamp-on design and can be positioned to sit above or below the windshield frame. The Ellipse Marine Mirror is constructed of heavy-duty durability tested materials and features OE grade glass. In order for glass meet OE standards it must be made utilizing a technique called first surface coating. First surface coating provides a high quality image that eliminates symptoms such as ghosting and multiple reflections. OE standards ensure high quality and a crisp clear view. The Ellipse Marine Mirror is the most advanced family recreational boat mirror available allowing a view of both sides of the boat as well as behind. Perfect for boats without wakeboard towers.

### Product Features:

- Great for boats with walkthrough windshields or boats without wakeboard towers. Ball and socket tension knob keeps the mirror where you position it
- Features one 3.25 x 6 inch convex stationary lens in the center and two adjustable 2.5 x 2.5 inch flat lenses on each side
- Most advanced family recreational boat mirror available allowing a view of both sides of the boat as well as behind
- Universal quick-mount, anti-scratch bracket mounts to rectangular or rounded windshield frames from 15/32 to 1-3/16 of an inch
- High quality mirror constructed of heavy-duty durability tested materials featuring OE grade glass



COLOR	MFG #	PART #	
Black	02003	530049	56.95 B

## VERSATILE COMPOSITE HIGH STRENGTH MIRROR BRACKET

The Deluxe Windshield Mirror Bracket will fit virtually any boat windshield. It has a depth of 1 7/8 inches, which is about a half inch more than most marine brackets currently on the market. The Deluxe bracket also has the ability to tilt forward for storage when not in use, rather than removing the entire unit. The Deluxe Windshield Bracket will fit the new CIPA Vison 180 Mirror (01600), CIPA COMP Universal (02000) and the CIPA Extreme (02022). The mirror heads are sold separately. CIPA is offering the Deluxe Windshield Mirror Brackets in black and silver "cup" mounts. It is made of high strength powder coated aluminum. The Deluxe Windshield Mirror Bracket will allow more boaters to be safer while on the water. Bracket styles are for mounting flexibility. Pivot system provides full 120° of adjustment for easy storage without need to remove bracket. Clam shell design accommodates most windshield trim sizes and shapes. No drilling required for installation.

### Product Features:

- Cup mounts available in Black
- Bracket styles are for mounting flexibility
- Pivot system provides full 120 of adjustment
- Clam shell design accommodates most windshield trim sizes and shapes
- No drilling required for installation



COLOR	MFG #	PART #	
Black	02350	530050	24.95 B



## PWC SPORT UNIVERSAL WING MIRROR

CIPA's PWC Sport Universal Wing Mirrors were designed exclusively to bring durability and style to your PWC. The mirrors are sized at 3.5 x 5.375 inches and 8 inches total in length and offers a dramatically wide rear view through sturdy convex safety glass for maximum PWC safety. These mirrors are the most durable in their class. The PWC Sport Universal Wing Mirrors are made with non-corrosive materials, and have been salt spray tested. They will quickly mount to the right or left side of your PWC, and will also tuck neatly beneath PWC canvas covers. PWC Sport Universal Wing Mirrors will hold adjustment even in the biggest waves. This mirror features a black paintable housing.

**Product Features:**

- Designed exclusively to bring durability and style to your PWC
- Sized at 3.5 x 5.375 inches and offer a dramatically wide rear view through sturdy convex safety glass for maximum PWC safety
- Made with non-corrosive materials, and salt spray tested
- Quickly mounts to the right or left side of your PWC, and will also tuck neatly beneath PWC canvas covers
- Holds adjustment even in the biggest waves
- Includes: 1 black rubber sport boot, 1 mirror head mounting base, 1 stainless tension spring, 1 stainless washer, 1 mounting plate, 1 mounting stud, 1 stainless Phillips hex head screw, 1 white nylon mounting washer, and instructions

COLOR	MFG #	PART #	
Black	11120	530051	25.95 B



## PWC SAFETY MIRROR SPORT II

The rugged and durable design of CIPA's PWC Safety Sport II Mirror allows them to hold adjustment even in the biggest waves on PWC's and mini jet boats. The PWC Sport II Mirror is universal in both fit and position. It will mount securely to most personal water crafts, and can be mounted on either the right hand side or the left hand side. The mirror faces measures 3.5 inches x 6.25 inches, and features shatterproof safety glass. The convex lens of the PWC Sport II Mirror provides a wider viewing angle for added safety and situational awareness. This mirror is a sporty compliment to any boat or PWC. Salt spray and UV tested for durability. Use two for maximum PWC Safety.

**Product Features:**

- Fits most Personal Water Crafts
- Rugged and durable construction
- Features shatterproof safety glass and a convex lens that provides for a wider viewing angle
- Universal positioning fits left or right side of PWC
- Holds adjustment even in the biggest waves on PWCs and mini jet boats

COLOR	MFG #	PART #	
Black	11160	530052	30.95 B



## HAND MIRROR

CIPA's Hand Mirror can be used on ATVs, Dirt Bikes, Snowmobiles, Bicycles, or just about anything. The Hand Mirror comes with an adjustable Velcro strap for quick and easy installation, and does not interfere with hand movement. Attaches to your hand and easily slips on and off. Velcro strap wraps around palm for quick and convenient use. Compact size stores conveniently whenever use is not desired. It may be the most convenient mirror you've ever owned. The Hand Mirror features a tough impact resistant convex acrylic lens that measures 3.5 x 2.25 inches.

**Product Features:**

- Vibration free convex safety lens for an added safety feature
- Easy to use adjustable velcro strap
- Can be used with left or right hand; won't interfere with hand movement
- Low Cost and high quality
- Best mirror in its class

COLOR	MFG #	PART #	
Black	11125	530053	5.95 B



- accessories
- towables
- body**
- controls
- electrical
- driveline
- engine
- fuel & intake
- chemicals
- tie downs
- tools
- towing & loading

**MARINE**



- accessories
- towables
- body**
- controls
- electrical
- driveline
- engine
- fuel & intake
- chemicals
- tie downs
- tools
- towing & loading

## SAFE-T-CLEAT

The number one cause of boating accidents is darkness. The Safe-T-Cleat is an eco-friendly solar powered dock cleat that creates enhanced visibility in all weather conditions. The 12-inch long cleat incorporates a solar panel that powers its integrated LED night light for up to ten hours when completely charged. Made from heavy duty, scratch resistant fiber-glass reinforced plastic; it resists rope chafing and withstands pressure up to 22,000 PSI. The Safe-T-Cleat comes in your choice of an ivory, black, or clear finish. Four mounting holes provide a wide footprint for secure docking of small and medium sized vessels up to 38' in length. Perfect for mounting on any flat surface, including: docks, seawalls, pontoon boats, and floating diving platforms. The Safe-T-Cleat operates using one 1.2V NI-MH battery and is included. Battery replacement is also easy. Four 3/8 bolts are required for installation. Bolts not included. The Safe-T-Cleat was designed with safety in mind. Made in the USA.

### Product Features:

- Lights automatically to provide a safe, eco-friendly dock environment
- Wide footprint provides docking security for any small to mid-size pleasure craft
- Long lasting replaceable battery
- Heavy-duty scratch resistant fiberglass reinforced plastic
- No rusting or rope chafing

COLOR	MFG #	PART #	
Clear	12100	<b>530054</b>	<b>45.95</b> B
Black	12110	<b>530055</b>	<b>45.95</b> B
White	12120	<b>530056</b>	<b>45.95</b> B



## THE CLEAT SEAT

The Cleat Seat Retractable Dock Cleat is the cleat seat that won't hurt your feet! The Cleat Seat provides the convenience of a dock cleat without the stubbed toes that often come along with them. This sturdy 6.5 inch x 10 inch dock cleat features a 2.75 inch high cleat that folds into a 1.25 inch low profile base to provide a smooth top surface. Coupled with its angled sides, this patented design prevents toe stubbing and tripping, and is a boating safety innovation that is provided only by CIPA. The Cleat Seat is also both strong and durable. It is made of a nylon composite that is rated at 27,000 pounds per square inch of tensile strength. The materials will not corrode in salt air, and is UV stabilized to deflect heat up to 400 degrees Fahrenheit. The Cleat Seat provides more safety and style than the old fashioned aluminum cleats. Accepts up to 1/2 inch dock line. The Cleat Seat is available in solid black, or in white with a black cleat part number 02101 (CS101). Mounting hardware not included.

### Product Features:

- Strong Nylon composite is rated at 27,000 pounds per square inch tensile strength
- Durable Materials will not corrode in salt air. UV Stabilized-heat deflection to 400 degrees Fahrenheit
- Attractive Looks much nicer than aluminum cleats
- Safe The cleat is not exposed when not in use
- Safe The sides of the cleat are angled to prevent toe stubbing and tripping

COLOR	MFG #	PART #	
Black	02100	<b>530057</b>	<b>26.95</b> B
White	02101	<b>530058</b>	<b>26.95</b> B

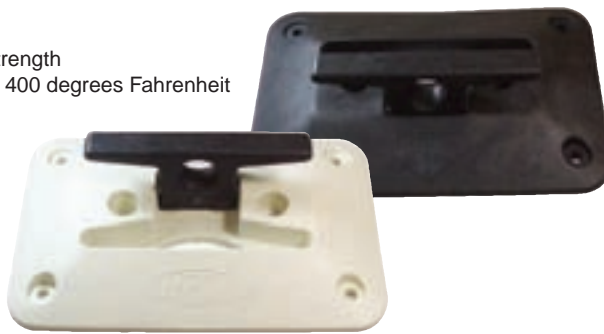

## ECONOMY MARINE MIRROR

CIPA's Economy Marine Mirror measures 2.5 x 8 inches and has a convex mirror surface to provide a wide viewing angle. The universal quick mounting system gives this mirror multiple mounting options. It can be mounted above or below the windshield, or to the dashboard. Windshield installation is easy and requires no tools. Fits round or square frames up to 7/8". The Economy Marine Mirror helps to eliminate blind spots, and provides added safety and situational awareness with a euro styling.

### Product Features:

- Measures 2.5 x 8 inches and has a convex mirror surface to provide a wide viewing angle
- Universal quick mounting system gives this mirror multiple mounting options. It can be mounted above or below the windshield, or to the dashboard
- Windshield installation is easy and requires no tools
- Fits round or square windshield frames up to 7/8 of an inch
- Helps to eliminate blind spots, and provides added safety and situational awareness with a euro styling

COLOR	MFG #	PART #	
Black	11119	<b>530059</b>	<b>13.95</b> B







## SUCTION CUP MARINE MIRROR

CIPA's Suction Cup Marine Mirror easily attaches to any clean, smooth, non-porous surface to provide added safety and situational awareness. It requires no tools to install, no holes to drill, and it won't scratch your boat. Once mounted, the flexible arm lets you fine-tune the mirror's placement. The mirror head measures at 4 by 8 inches, and contains convex glass for wide angle viewing. When it comes to boating, being safe is just as important as having fun.

**Product Features:**

- Rear-view marine mirror provides added safety and situational awareness
- Powerful suction cup mount for easy, tool-free installation
- Large 4 inch x 8 inch mirror surface
- Convex glass for a wider viewing angle
- Adjustable mounting arm provides perfect positioning



COLOR	MFG #	PART #	
Black	11050	530060	20.95 B

## BOATING SAFETY MIRROR

CIPA's Boating Safety Mirror is for water skiing and general boating safety. It features a fully adjustable anti-scratch, quick mount plastic bracket that fits square windshields up to 3/4 of an inch thick. The Boating Safety Mirror is designed to universally mount above or below the windshield frame, offering maximum rear view with a few simple adjustments. The ability to mount in the down position makes this mirror perfect for boats with walk-thru windshields.

The mirror head on the Boating Safety Mirror measures 4.25 x 8 inches and features a convex acrylic safety lens for wide angle viewing and added safety. Each package includes two different anti-scratch mounting plates. One for standard thickness windshield frames (5/8-inch to 3/4-inch), and the other for frames thinner than 5/8-inches. Mirrors are made with non-corrosive materials and are salt spray tested.

**Product Features:**

- Features a fully adjustable anti-scratch, quick mount plastic bracket that fits square windshields up to 3/4 of an inch thick
- Can mount above or below the windshield - Perfect for walk-thru windshields
- Features a convex acrylic safety lens for wide angle viewing and added safety
- Mirror head measures 4.25 x 8 inches
- Made with non-corrosive materials and salt spray tested



COLOR	MFG #	PART #	
Black	11140	530061	26.95 B

- accessories
- towables
- body**
- controls
- electrical
- driveline
- engine
- fuel & intake
- chemicals
- tie downs
- tools
- towing & loading



**MARINE**

# BODY

## HYDRO-TURF MATS

Replace your factory mats with Grooved mats from Hydro-Turf. Provides traction and a new look. Add 3M PSA for faster, easier, cleaner installation. All Hydro-Turf mats come black cut grooved with "PSA" (pressure sensitive adhesives).



- accessories
- towables
- body**
- controls
- electrical
- driveline
- engine
- fuel & intake
- chemicals
- tie downs
- tools
- towing & loading

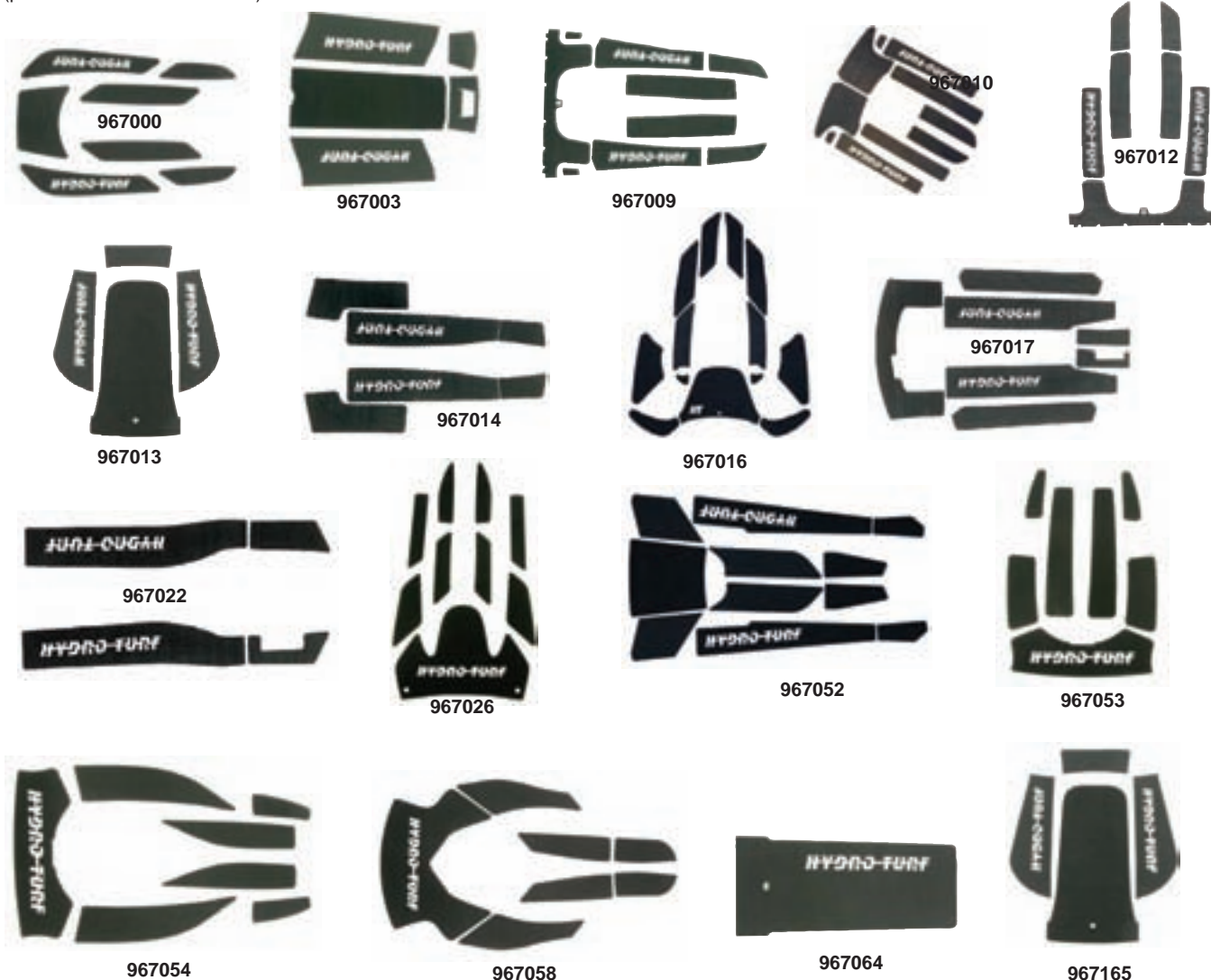

MARINE

DESCRIPTION	PART #		
<b>HONDA</b>			
F-12 / F-12X	967000	99.00	E
R-12 / R12-X	967001	99.00	E
F-15X	967002	99.00	E
<b>KAWASAKI</b>			
JS 300 / 440 / 550	967003	99.00	E
X2	967004	99.00	E
550 SX	967306	TBA	
Zxi	967006	99.00	E
Ultra 150 / Ultra 130	967007	99.00	E
Ultra 250 / Ultra LX (07-14) / 260 LX (09-15) / 300 & 310 (13-16)	967008	99.00	E
ST / STS / 750 STX & 900 STX (Pre 99)	967009	99.00	E
1100 STX (97-99) / 900 STX (99-00) / 900 STS (01-02)	967010	99.00	E
1100 STX DI (00-02) / All STX (01-16)	967011	99.00	E
650 SX	967163	68.95	E
750 SS / Xi / XiR	967012	99.00	E
750 SX / Sxi (NO PSA)	967164	68.95	E
800 SXR	967165	99.00	E

DESCRIPTION	PART #		
<b>YAMAHA</b>			
WaveRunner 500 & 650	967014	99.00	E
FX1	967015	99.00	E
SUV	967016	109.00	E
WaveRunner III	967017	99.00	E
WaveBlaster	967018	99.00	E
WaveBlaster II	967019	99.00	E
WaveBlaster 800	967020	99.00	E
WaveRaider	967021	99.00	E
VXR / VXR Pro (Pre 2010)	967022	99.00	E
Venture, XL 1200 (98), XL 700 & 760 (98-04)	967023	99.00	E
XL 1200 Ltd (99-04) / XL 800, XLT 800, XLT 1200	967024	99.00	E
GP / GP 1200R (99)	967025	99.00	E
GP 1200R & GP 1300R (00-02) / GP 800R (01-05)	967026	99.00	E
FX / FX HO (02-09)	967027	99.00	E
FX SHO (08-11) / FX HO (10-11) / FZR & FZS (09-16)	967028	99.00	E
FX HO, Cruiser HO, FX SHO, Cruiser SHO, FX SVHO, Cruiser SVHO (12-16)	967029	99.00	E

**HYDRO-TURF MATS CONTINUED**

DESCRIPTION	PART #	
<b>YAMAHA CONTINUED</b>		
VX (05-09)	967030	99.00 E
VX, VXS, VXR, VX Sport, VX Dlx & VX Cruiser (10-14) / V1 & V1 Sport (15-16)	967031	99.00 E
VXR, VXS, VX Limited, VX Cruiser, VX Cruiser HO, VX Deluxe, VX (15-16)	967307	TBA
<b>SEA-DOO</b>		
XP (Pre 93) / SP Family (Pre 94)	967032	99.00 E
Spark (14-16) 2 Seater	967308	TBA
Spark (14-16) 3 Seater	967309	TBA
GT Family (90-95) GTI (96) / GTS (96-00)	967033	99.00 E
GTX (96-02) / GTI (97-00)	967034	99.00 E
GTS (01) / GTI (01-05)	967035	99.00 E
GTI 4-Tech (06-08)	967036	109.00 E
XP (93-96) / SP Family (94-99)	967037	99.00 E
GS Family	967038	99.00 E
XP (97-04)	967039	99.00 E
LRV	967040	99.00 E
RX / RXX	967041	99.00 E
HX	967042	99.00 E
GTX (03-08) / GTX 4-TEC (02-05) / GTX DI (02) / RXT & X (Pre 09)	967043	99.00 E
RXT IS, IS 260 & aS 260 (09-16) / GTX Limited IS (09-16) / GTX S 155 (12-16)	967044	125.00 E
GTI 130, GTI SE 130 (11-16) / GTI Ltd 155, GTI SE 155 / GTS 130 / Wake 155 / GTR 215 (12-16)	967045	99.00 E
RXT-X 260 & RXT 260 (12-16) / RXT-X (10-11) / Wake Pro 215 (12-16) GTX 155/215 (12-16)	967046	99.00 E
RXP (Pre 06)	967047	99.00 E
RXP (06-11) / RXP-X (08-11)	967048	99.00 E
RXP-X 260, RXP-X 300 (12-16)	967049	99.00 E
3D	967050	109.00 E
<b>POLARIS</b>		
SL / SLX (Pre 99) / Pro 785 (99-01)	967051	99.00 E
Hurricane	967052	109.00 E
SLXH (98) / SLH & SLX (99)	967053	99.00 E
SLH / SLX / Pro 1200 (00-01)	967054	99.00 E
SLT / SLTX / X-45	967055	99.00 E
Virage / Freedom	967056	99.00 E
Genesis	967057	99.00 E
MSX	967058	109.00 E

**HYDRO TURF CONTACT CEMENT**

16 oz. can liquid contact cement. Great for all your Hydro-Turf mat applications!



QTY	PART #	MFG #	
16 oz	967168	CC20	14.00 E



- accessories
- towables
- body**
- controls
- electrical
- driveline
- engine
- fuel & intake
- chemicals
- tie downs
- tools
- towing & loading

**MARINE**

## LUNEX RS-2™ BOAT COVER

Heavy-duty boat cover designed for both long-term storage and highway travel



- Extra strength Lunex RS™ ripstop fabric side panels designed for extra durability and Lunex™ fabric top panel provide all-weather protection
- Integrated buckle and strap system for easy fitting and trailering, adjustable straps snap into quick-release buckles on the cover
- Bow and stern reinforcement panels provide added strength
- Full cut to allow extra room for accessories such as bow rails, running lights, etc.
- Support pole included to prevent water from pooling and help preserve the cover
- Dual rear air vents reduce wind pressure during trailering and storms and allow inside moisture to escape
- Elastic cord sewn into bottom hem gives a tight, custom fit
- Fabric coating technology provides water-resistance and repellency, while protecting boat against dirt and stains
- Resistant to mildew and protects boat from UV damage
- Storage bag and trailering straps included
- 5 Year Warranty



FITS	COLOR	MFG #	PART #		
<b>Model A</b> 14' - 16' L (beam width to 75") • V-Hull Fishing Boats	Linen/Navy	20-131-084601-00	<b>394091</b>	<b>196.95</b>	G
<b>Model B</b> 14' - 16' L (beam width to 90") • V-Hull Runabouts (Outboards and I/O) • Aluminum Bass Boats • Lund Boats	Linen/Navy	20-132-094601-00	<b>394092</b>	<b>234.95</b>	G
<b>Model C</b> 16' - 18.5' L (beam width to 98") • Fish and Ski Boats • Pro -style Bass Boats	Linen/Navy	20-133-104601-00	<b>394093</b>	<b>259.95</b>	G
<b>Model D</b> 17' - 19' L (beam width to 102") • V-Hull Runabouts (Outboards and I/O)	Linen/Navy	20-134-114601-00	<b>394094</b>	<b>277.95</b>	G
<b>Model E</b> 20' - 22' L (beam width to 106") • V-hull Runabouts (Outboards and I/O)	Linen/Navy	20-135-124601-00	<b>394095</b>	<b>308.95</b>	G
<b>Model F</b> 22' - 24' L (beam width to 116") V-Hull Runabouts (Outboards and I/O)	Linen/Navy	20-136-134601-00	<b>394096</b>	<b>349.95</b>	G

## How to Measure Your Boat for a Cover

To get the proper fit, there are two key measurements you need to get right: the Length and Beam Width

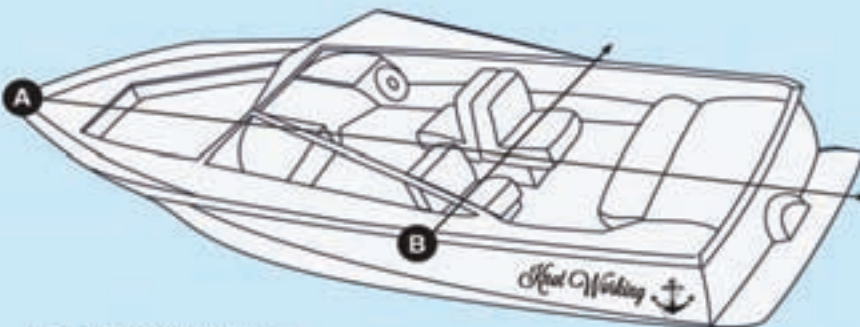

- A Length/Center Line**  
Measure your boat's flat measurement from bow to stern. Do not include the motor. Don't even think about including the height of the windshield. But if your boat has a swim deck or platform and you want it covered, include it.
- B Beam Width**  
Measure the widest part of your boat, usually mid-ship.

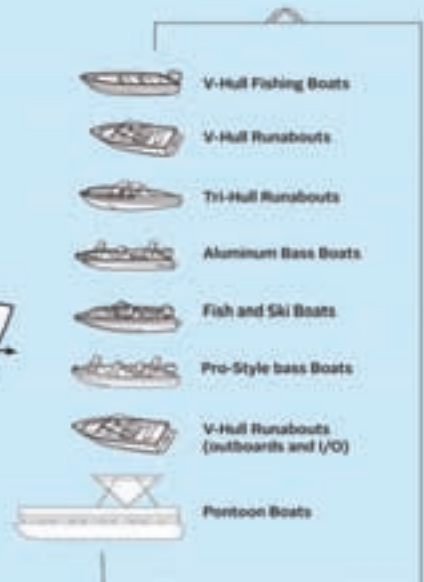

## STORMPRO™ BOAT COVER

Heavy-duty trailerable boat cover

- High strength polyester StormPro™ fabric designed for extra durability and all-weather protection
- Fabric coating technology and heavy-duty fabric for maximum water-resistance and repellency
- Resistant to mildew and UV damage
- Storage bag and trailering straps included
- Integrated buckle and strap system for easy fitting and trailering, adjustable straps snap into quick-release buckles on the cover
- Full cut to allow extra room for accessories such as bow rails, running lights, etc.
- Elastic cord sewn into bottom hem gives a tight, custom fit
- Support pole included to prevent water from pooling and help preserve the cover
- Dual rear air vents with built-in stiffeners reduce wind pressure during trailering and storms and allow inside moisture to escape
- 5 Year Warranty



accessories

towables

body

controls

electrical

driveline

engine

fuel & intake

chemicals

tie downs

tools

towing & loading

FITS	COLOR	MFG #	PART #		
<b>Model A</b>					
14' to 16' L (beam width to 75"):	Charcoal	88918	<b>394103</b>	<b>141.95</b>	G
• V-Hull Fishing Boats					
<b>Model B</b>					
14' to 16' L (beam width to 90"):	Charcoal	88928	<b>394104</b>	<b>162.95</b>	G
• V-Hull Runabouts (Inboards and Outboards)					
• Tri-Hull Runabouts (Inboards and Outboards)					
• Aluminum Bass Boats					
<b>Model C</b>					
16' to 18.5' L (beam width to 98"):	Charcoal	88938	<b>394105</b>	<b>190.95</b>	G
• Fish and Ski Boats					
• Pro-Style Bass Boats					
<b>Model D</b>					
17' to 19' L (beam width to 102"):	Charcoal	88948	<b>394106</b>	<b>202.95</b>	G
• V-Hull Runabouts (Inboards and Outboards)					
<b>Model E</b>					
20' to 22' L (beam width to 106"):	Charcoal	88958	<b>394107</b>	<b>247.95</b>	G
• V-Hull Runabouts (Inboards and Outboards)					
<b>Model F</b>					
22' to 24' L (beam width to 116"):	Charcoal	88968	<b>394108</b>	<b>269.95</b>	G
• V-Hull Runabouts (Inboards and Outboards)					

## STORMPRO™ PONTOON BOAT COVER

Heavy-duty trailerable pontoon boat cover



- High-strength polyester StormPro™ fabric designed for extra durability and all-weather protection
- Integrated buckle and strap system for easy fitting and trailering, adjustable straps snap into quick-release buckles on the cover
- Adjustable transom flap and an elastic cord sewn into the bottom hem provides a tight, custom fit
- Dual air vents reduce inside moisture and ballooning of cover at high speeds
- Fabric coating technology and heavy-duty fabric for maximum water-resistance and repellency
- Resistant to mildew and UV damage
- Storage bag, trailering straps, transom flap tie down rope and two stern-fit elastic cords included
- 5 Year Warranty

FITS	COLOR	MFG #	PART #		
<b>Model A</b>					
17' to 20' L (beam width to 102"):	Charcoal	20-027-080801-00	<b>394118</b>	<b>414.95</b>	G
• Pontoon Boats					
<b>Model B</b>					
21' to 24' (beam width to 102"):	Charcoal	20-028-090801-00	<b>394119</b>	<b>451.95</b>	G
• Pontoon Boats					

MARINE

## STELLEXTM BOAT COVER

Light and strong trailerable boat cover resists sun fade and provides UV protection



- Tough polyester Stellex™ fabric designed for durability and weather protection shrink
- Integrated buckle and strap system for easy fitting and trailering, adjustable straps snap into quick-release buckles on the cover
- Full cut to allow extra room for accessories such as bow rails, running lights, etc.
- Elastic cord sewn into bottom hem for a tight, custom fit
- Fabric coating technology resists dirt and stains while providing water-resistance
- Resistant to mildew and UV damage
- Storage bag and trailering straps included
- Quick-release buckle and strap system for easy fitting and trailering
- 4 Year Warranty



FITS	COLOR	MFG #	PART #	
<b>Model AA</b>				
12' to 14' L (beam width to 68"):	Blue	20-144-070501-00	<b>394109</b>	<b>100.95</b> G
• V-Hull Fishing Boats				
<b>Model A</b>				
14' to 16' L (beam width to 75"):	Blue	20-145-080501-00	<b>394110</b>	<b>111.95</b> G
• V-Hull Fishing Boats				
<b>Model B</b>				
14' to 16' L (beam width to 90"):	Blue	20-146-090501-00	<b>394111</b>	<b>123.95</b> G
• V-Hull Runabouts (Inboards and Outboards)				
• Tri-Hull Runabouts (Inboards and Outboards)				
• Aluminum Bass Boats				
<b>Model C</b>				
16' to 18.5' L (beam width to 98"):	Blue	20-147-100501-00	<b>394112</b>	<b>149.95</b> G
• Fish and Ski Boats				
• Pro-Style Bass Boats				
<b>Model D</b>				
17' to 19' L (beam width to 102"):	Blue	20-148-110501-00	<b>394113</b>	<b>158.95</b> G
• V-Hull Runabouts (Inboards and Outboards)				
<b>Model E</b>				
20' to 22' L (beam width to 106"):	Blue	20-149-120501-00	<b>394090</b>	<b>181.95</b> G
• V-Hull Runabouts (Inboards and Outboards)				

## STELLEXTM PONTOON BOAT COVER

All-season pontoon boat cover



- Tough Stellex™ fabric designed for durability and weather protection
- Fits most popular pontoon boats
- Rope attaches to rugged non-scratch D-rings, no grommets to pull out or scratch
- Adjustable transom flap and an elastic cord sewn into the bottom hem provides a tight, custom fit
- Resistant to mildew and UV damage
- 4 Year Warranty

FITS	COLOR	MFG #	PART #	
<b>Model A</b>				
17' to 20' L (beam width to 102"):	Blue	20-150-080501-00	<b>394120</b>	<b>391.95</b> G
• Pontoon Boats				
<b>Model B</b>				
21' to 24' L (beam width to 102"):	Blue	20-151-090501-00	<b>394121</b>	<b>438.95</b> G
• Pontoon Boats				

## LUNEX RS-1™ BOAT COVER

Strong and light trailerable boat cover resists sun fade and provides UV protection

- Lunex™ ripstop is an advanced, highly durable fabric that uses a grid system to make the fabric stronger and tear resistant
- Integrated trailering strap with ladderlock for webbing, D-ring and rope attachments
- Elastic cord bound into bottom hem for a tight, custom fit
- Resistant to mildew and protects boat from UV damage
- Storage bag, attachment webbing and ropes included
- Quick-release buckle and strap system for easy fitting and trailering
- 1 Year Warranty



FITS	COLOR	MFG #	PART #		
<b>Model AA</b>					
12' to 14' L (beam width to 68"):	Grey	20-139-071001-00	<b>394114</b>	<b>82.95</b>	G
• V-Hull Fishing Boats					
<b>Model A</b>					
14' to 16' L (beam width to 75"):	Grey	20-140-081001-00	<b>394115</b>	<b>87.95</b>	G
• V-Hull Fishing Boats					
<b>Model B</b>					
14' to 16' L (beam width to 90"):	Grey	20-141-091001-00	<b>394116</b>	<b>103.95</b>	G
• V-Hull Runabouts (Inboards and Outboards)					
• Tri-Hull Runabouts (Inboards and Outboards)					
• Aluminum Bass Boats					
<b>Model C</b>					
16' to 18.5' L (beam width to 98"):	Grey	20-142-101001-00	<b>394089</b>	<b>112.95</b>	G
• Fish and Ski Boats					
• Pro-Style Bass Boats					
<b>Model D</b>					
17' to 19' L (beam width to 102"):	Grey	20-143-111001-00	<b>394117</b>	<b>122.95</b>	G
• V-Hull Runabouts (Inboards and Outboards)					

## DRYGUARD™ BOAT COVER

Strong DryGuard™ fabric with waterproof lamination

- Strong DryGuard™ fabric for durability and tear-resistance to trailering and weather
- Resistant to mildew and UV damage
- Integrated buckle and strap system for easy fitting and trailering, adjustable straps snap into quick-release buckles on the cover
- Dual rear air vents with built-in stiffeners reduce wind pressure during trailering and storms and allow inside moisture to escape
- Reinforcement panels on bow, windshield and stern for additional protection
- Elastic cord in bottom hem gives a tight, custom fit
- Full cut to allow extra room for accessories
- Mesh storage bag and trailering straps included
- Taped seam construction blocks water from entering through the stitching
- 4 Year Warranty



FITS	COLOR	MFG #	PART #		
<b>Model A</b>					
14' to 16' L (beam width to 75"):	Tan	20-083-082401-00	<b>394097</b>	<b>190.95</b>	G
• V-Hull Fishing Boats					
<b>Model B</b>					
14' to 16' L (beam width to 90"):	Tan	20-084-092401-00	<b>394098</b>	<b>227.95</b>	G
• V-Hull Runabouts (Inboards and Outboards)					
• Tri-Hull Runabouts (Inboards and Outboards)					
• Aluminum Bass Boats					
<b>Model C</b>					
16' to 18.5' L (beam width to 98"):	Tan	20-085-102401-00	<b>394099</b>	<b>251.95</b>	G
• Fish and Ski Boats					
• Pro-Style Bass Boats					
<b>Model D</b>					
17' to 19' (beam width to 102"):	Tan	20-086-112401-00	<b>394100</b>	<b>269.95</b>	G
• V-Hull Runabouts (Inboards and Outboards)					
<b>Model E</b>					
20' to 22' L (beam width to 106"):	Tan	20-087-122401-00	<b>394101</b>	<b>299.95</b>	G
• V-Hull Runabouts (Inboards and Outboards)					
<b>Model F</b>					
22' to 24' (beam width to 116"):	Tan	20-088-132401-00	<b>394102</b>	<b>339.95</b>	G
• V-Hull Runabouts (Inboards and Outboards)					

- accessories
- towables
- body**
- controls
- electrical
- driveline
- engine
- fuel & intake
- chemicals
- tie downs
- tools
- towing & loading



## LUNEX RS-1™ PERSONAL WATERCRAFT COVER

Strong and light with an integrated trawling system

- Lunex RS™ ripstop is an advanced, highly durable fabric that uses a grid system to make the fabric stronger and tear resistant
- Trawling strap included
- Provides UV protection
- Elastic cord in bottom hem provides a quick and secure fit
- Rear air vent reduces inside moisture and wind lofting
- Integrated storage bag and tie-town rope included



FITS	COLOR	MFG #	PART #		
<b>MEDIUM</b>					
Personal Watercrafts up to 133" L	Grey	20-215-031001-00	<b>394129</b>	<b>64.95</b>	G
<b>LARGE</b>					
Personal Watercrafts up to 140" L	Grey	20-216-041001-00	<b>394130</b>	<b>66.95</b>	G

## STELLEXTM PERSONAL WATERCRAFT TRAVEL & STORAGE COVER

All-season travel cover with an integrated trawling system

- Tough polyester Stellex fabric designed for durability and weather protection
- Integrated trawling system with built-in quick adjusting side-release straps
- Rear air vents reduce inside moisture and wind lofting
- Zippered access door on both sides
- Elastic cord in bottom hem provides a quick and secure fit
- Tension panels tightly secure cover for highway travel
- Built-in strap keepers secure excess strap after tightening
- Integrated storage bag
- 4 Year Warranty



FITS	COLOR	MFG #	PART #		
<b>MEDIUM</b>					
Personal Watercrafts up to 133" L	Blue	20-208-030501-00	<b>394127</b>	<b>102.95</b>	G
<b>LARGE</b>					
Personal Watercrafts up to 140" L	Blue	20-209-040501-00	<b>394128</b>	<b>105.95</b>	G

- accessories
- towables
- body**
- controls
- electrical
- driveline
- engine
- fuel & intake
- chemicals
- tie downs
- tools
- towing & loading





## STELLEXTM BOAT FOLDING SEAT COVER

Protects a variety of boat seats from dirt, sun and weather

- Tough polyester Stellex™ fabric designed for durability and weather protection
- Folds easy for storage
- Elastic cord in bottom hem provides a quick and secure fit
- Fabric coating technology resists dirt and stains while providing water-resistance and repellency
- Provides UV protection
- All-season protection
- 4-year warranty



FITS	COLOR	MFG #	PART #
Most Pedestal Folding Seats up to 17.25"L x 20"W x 13"H	Blue	20-217-010501-00	<b>394124</b> 16.95 G

## STELLEXTM ALWAYS READY BOAT SEAT COVER

Just pull it out from its pack under the seat; this cover is always ready for use

- Tough polyester Stellex™ fabric designed for durability and weather protection
- Pack attaches quickly to the boat seat with quick-release straps
- Elastic cord in bottom hem provides a quick and secure fit
- Provides UV protection
- All-season protection
- 4 Year warranty



FITS	COLOR	MFG #	PART #
Most Pedestal Boat Seats	Blue	20-222-010501-00	<b>394125</b> 30.95 G

- accessories
- towables
- body**
- controls
- electrical
- driveline
- engine
- fuel & intake
- chemicals
- tie downs
- tools
- towing & loading

**MARINE**

- accessories
- towables
- body**
- controls
- electrical
- driveline
- engine
- fuel & intake
- chemicals
- tie downs
- tools
- towing & loading



## GUARDIAN PWC COVERS

Dowco Guardian® Covers have been the powersports industry leading cover for years. Offering covers to fit virtually every Motorcycle, ATV, UTV, PWC or Snowmobile on the market, protect your investment today and start keeping your equipment in top condition with a Guardian® Cover.

*Why buy Guardian® Covers?*

- Industry leader in covers for over 35 years
- The Most Lifetime Warranties in the Industry
- Industry Leading Climashield® Plus Fabric for Superior UV and Fade Protection
- Advanced Features including Moisture-Guard® Vent System, Waterproof Seams and Lockable Grommets

Dowco Guardian® Covers. Buy the Best!



MARINE

APPLICATION	YEAR	STORAGE (BLUE)		STORAGE (BLUE/CHARCOAL)		TRAILERABLE CUSTOM			
		MFG #	PART #	MFG #	PART #	MFG #	PART #		
<b>ARCTIC CAT</b>									
Daytona 1000 R (seats 2)	97	----	----	52049-00	<b>905068</b>	<b>135.99</b>	H	----	----
Daytona 770	96	----	----	52049-00	<b>905068</b>	<b>135.99</b>	H	----	----
Daytona TS 770	97	----	----	52049-00	<b>905068</b>	<b>135.99</b>	H	----	----
Monte Carlo	94-97	----	----	52049-00	<b>905068</b>	<b>135.99</b>	H	----	----
Monte Carlo 640	96-97	----	----	52049-00	<b>905068</b>	<b>135.99</b>	H	----	----
Monte Carlo 900	96-97	52070-00	<b>905072</b>	<b>116.99</b>	H	52071-00	<b>905073</b>	<b>151.99</b>	H
Montego Dlx. (seats 2)	96-97	52070-00	<b>905072</b>	<b>116.99</b>	H	52071-00	<b>905073</b>	<b>151.99</b>	H
TS 640L (seats 2)	98	52070-00	<b>905072</b>	<b>116.99</b>	H	52071-00	<b>905073</b>	<b>151.99</b>	H
TS 770 (seats 2)	98	52070-00	<b>905072</b>	<b>116.99</b>	H	52071-00	<b>905073</b>	<b>151.99</b>	H



**GUARDIAN PWC COVERS  
CONTINUED**

MODEL		STORAGE (BLUE)		STORAGE (BLUE/CHARCOAL)			TRAILERABLE CUSTOM	
		MFG #	PART #	MFG #	PART #	MFG #	PART #	
<b>KAWASAKI</b>								
440	92	52001-00	<b>905047 78.99</b> H	----	----	----	----	
550	92-93	52001-00	<b>905047 78.99</b> H	----	----	----	----	
1100 STX	99	52068-00	<b>905144 123.99</b> H	----	----	----	----	
1100 STX DI	99-01	52068-00	<b>905144 123.99</b> H	----	----	----	----	
1100 ZXI	03	----	----	52049-00	<b>905068 135.99</b> H	----	----	
1100 ZXI	99-01	52011-00	<b>905130 116.99</b> H	52029-00	<b>905135 145.99</b> H	----	----	
650 SX Standup	92-93	52003-00	<b>905127 84.99</b> H	52026-00	<b>905134 123.99</b> H	----	----	
750 ST	94-98	52018-00	----	52036-00	<b>905138 123.99</b> H	----	----	
750 STX	94-98	52070-00	<b>905072 116.99</b> H	52071-00	<b>905073 151.99</b> H	----	----	
750 Super Sport	92-97	52015-00	<b>905054 106.99</b> H	52039-00	<b>905140 116.99</b> H	----	----	
750 Super Sport XI	93-97	52015-00	<b>905054 106.99</b> H	52039-00	<b>905140 116.99</b> H	----	----	
750 SXI Pro	01	52070-00	<b>905072 116.99</b> H	52071-00	<b>905073 151.99</b> H	----	----	
900 STS	01	52068-00	<b>905144 123.99</b> H	----	----	----	----	
900 STX	97-01	52068-00	<b>905144 123.99</b> H	----	----	----	----	
JS 300	92	52001-00	<b>905047 78.99</b> H	----	----	----	----	
ST	94-96	52011-00	<b>905130 116.99</b> H	52029-00	<b>905135 145.99</b> H	----	----	
Super Sport XI	93-98	52015-00	<b>905054 106.99</b> H	52039-00	<b>905140 116.99</b> H	----	----	
SXI Pro	98	52015-00	<b>905054 106.99</b> H	52039-00	<b>905140 116.99</b> H	----	----	
TS	92-96	52070-00	<b>905072 116.99</b> H	52071-00	<b>905073 151.99</b> H	----	----	
Ultra 130 DI	99-01	52011-00	<b>905130 116.99</b> H	52029-00	<b>905135 145.99</b> H	----	----	
Ultra 130 DI	02-04	----	----	52049-00	<b>905068 135.99</b> H	----	----	
Ultra 150 DI	99-01	52011-00	<b>905130 116.99</b> H	52029-00	<b>905135 145.99</b> H	----	----	
Ultra 150 DI	02-04	----	----	52049-00	<b>905068 135.99</b> H	----	----	
XI Sport	98	52015-00	<b>905054 106.99</b> H	52039-00	<b>905140 116.99</b> H	----	----	
<b>POLARIS</b>								
Freedom	02-04	52068-00	<b>905144 123.99</b> H	----	----	----	----	
Genesis I	04	52076-00	<b>905150 100.99</b> H	----	----	----	----	
Genesis I	02-04	52076-00	<b>905150 100.99</b> H	----	----	----	----	
Hurricane	96-98	52018-00	----	52036-00	<b>905138 123.99</b> H	----	----	
PRO 785	96-98	52018-00	----	52036-00	<b>905138 123.99</b> H	----	----	
SL 1050	97	52018-00	----	52036-00	<b>905138 123.99</b> H	----	----	
SL 650	92-95	52018-00	----	52036-00	<b>905138 123.99</b> H	----	----	
SL 700	96-97	52018-00	----	52036-00	<b>905138 123.99</b> H	----	----	
SL 700 Dlx	97	52018-00	----	52036-00	<b>905138 123.99</b> H	----	----	
SL 750	92-95	52018-00	----	52036-00	<b>905138 123.99</b> H	----	----	
SL 780	96-97	52018-00	----	52036-00	<b>905138 123.99</b> H	----	----	
SLH	00-01	52011-00	<b>905130 116.99</b> H	52029-00	<b>905135 145.99</b> H	----	----	
SLH	97-98	52018-00	----	52036-00	<b>905138 123.99</b> H	----	----	
SLT 700	94-97	52018-00	----	52036-00	<b>905138 123.99</b> H	----	----	
SLT 750	94-97	52018-00	----	52036-00	<b>905138 123.99</b> H	----	----	
SLT 780	94-97	52070-00	<b>905072 116.99</b> H	52071-00	<b>905073 151.99</b> H	----	----	
SLTH	97	52018-00	----	52036-00	<b>905138 123.99</b> H	----	----	
SLTH	98-99	52011-00	<b>905130 116.99</b> H	52029-00	<b>905135 145.99</b> H	----	----	
SLTX	99	52011-00	<b>905130 116.99</b> H	52029-00	<b>905135 145.99</b> H	----	----	
SLTX	94-98	52018-00	----	52036-00	<b>905138 123.99</b> H	----	----	
SLX	00-01	52011-00	<b>905130 116.99</b> H	52029-00	<b>905135 145.99</b> H	----	----	
SLX PRO 785	97	52018-00	----	52036-00	<b>905138 123.99</b> H	----	----	
SLXH	97-98	52018-00	----	52036-00	<b>905138 123.99</b> H	----	----	
Virage	01-03	52068-00	<b>905144 123.99</b> H	----	----	----	----	
Virage I	02-03	52068-00	<b>905144 123.99</b> H	----	----	----	----	
Virage TX	01-02	52068-00	<b>905144 123.99</b> H	----	----	----	----	
Virage TXI	02	52068-00	<b>905144 123.99</b> H	----	----	----	----	
X45	99	52011-00	<b>905130 116.99</b> H	52029-00	<b>905135 145.99</b> H	----	----	

- accessories
- towables
- body**
- controls
- electrical
- driveline
- engine
- fuel & intake
- chemicals
- tie downs
- tools
- towing & loading

**MARINE**



## GUARDIAN PWC COVERS CONTINUED

- accessories
- towables
- body
- controls
- electrical
- driveline
- engine
- fuel & intake
- chemicals
- tie downs
- tools
- towing & loading

MODEL		STORAGE (BLUE)			STORAGE (BLUE/CHARCOAL)			TRAILERABLE CUSTOM	
		MFG #	PART #		MFG #	PART #		MFG #	PART #
<b>SEA-DOO</b>									
Bombardier RX	01	52068-00	<b>905144</b>	<b>123.99</b>	H	----	----	----	----
GT	91	52011-00	<b>905130</b>	<b>116.99</b>	H	52029-00	<b>905135</b>	<b>145.99</b>	H
GTI	99-04	52068-00	<b>905144</b>	<b>123.99</b>	H	----	----	----	----
GTI (w/optional touring seat)	96	52011-00	<b>905130</b>	<b>116.99</b>	H	52029-00	<b>905135</b>	<b>145.99</b>	H
GTI LE RFI	03	52068-00	<b>905144</b>	<b>123.99</b>	H	----	----	----	----
GTX	97-98	52068-00	<b>905144</b>	<b>123.99</b>	H	----	----	----	----
GTX	01	52068-00	<b>905144</b>	<b>123.99</b>	H	----	----	----	----
RX	02	52011-00	<b>905130</b>	<b>116.99</b>	H	52029-00	<b>905135</b>	<b>145.99</b>	H
RX DI	02-03	52011-00	<b>905130</b>	<b>116.99</b>	H	52029-00	<b>905135</b>	<b>145.99</b>	H
RXX	02	52011-00	<b>905130</b>	<b>116.99</b>	H	52029-00	<b>905135</b>	<b>145.99</b>	H
SP	92-98	52008-00	<b>905050</b>	<b>106.99</b>	H	----	----	----	----
SPX	92-98	52008-00	<b>905050</b>	<b>106.99</b>	H	----	----	----	----
XP	02	----	----	----	----	52049-00	<b>905068</b>	<b>135.99</b>	H
XP DI	03	----	----	----	----	52049-00	<b>905068</b>	<b>135.99</b>	H
<b>YAMAHA</b>									
FX Cruiser	03-04	52076-00	<b>905150</b>	<b>100.99</b>	H	----	----	----	----
FX-1	94-95	52001-00	<b>905047</b>	<b>78.99</b>	H	----	----	----	----
FX-140 / FX-140 HO	04	52076-00	<b>905150</b>	<b>100.99</b>	H	----	----	----	----
Super Jet	92-99	52010-00	<b>905129</b>	<b>116.99</b>	H	----	----	----	----
VXR	92-95	52006-00	<b>905128</b>	<b>100.99</b>	H	52032-00	<b>905136</b>	<b>111.99</b>	H
VXR PRO	92-95	52006-00	<b>905128</b>	<b>100.99</b>	H	52032-00	<b>905136</b>	<b>111.99</b>	H
Wave Raider 1100	94-98	52046-00	<b>905065</b>	<b>116.99</b>	H	52047-00	<b>905141</b>	<b>129.99</b>	H
Wave Raider 700	94-98	52046-00	<b>905065</b>	<b>116.99</b>	H	52047-00	<b>905141</b>	<b>129.99</b>	H
Wave Raider 760	94-98	52046-00	<b>905065</b>	<b>116.99</b>	H	52047-00	<b>905141</b>	<b>129.99</b>	H
Wave Runner	94-95	52010-00	<b>905129</b>	<b>116.99</b>	H	52020-00	<b>905132</b>	<b>135.99</b>	H
Wave Runner 1200	97-98	52070-00	<b>905072</b>	<b>116.99</b>	H	52071-00	<b>905073</b>	<b>151.99</b>	H
Wave Runner 760	97-98	52070-00	<b>905072</b>	<b>116.99</b>	H	52071-00	<b>905073</b>	<b>151.99</b>	H
Wave Runner GP 1200R	01	52070-00	<b>905072</b>	<b>116.99</b>	H	52071-00	<b>905073</b>	<b>151.99</b>	H
Wave Runner III	92-97	52070-00	<b>905072</b>	<b>116.99</b>	H	----	----	----	----
Wave Runner LX	92-93	52006-00	<b>905128</b>	<b>100.99</b>	H	52032-00	<b>905136</b>	<b>111.99</b>	H



# CONTROLS

## MOTO GRIPS

If you are looking for a quick way to customize your PWC without spending a fortune, replacing the standard grips on your ride is a simple solution. The Moto Grip Brand offers sick-looking patented grip design that is engineered for extreme performance. The grips are made with a premium gel compound that is formulated to be easy on your hands, reduce arm pump and bar vibrations, so there is plenty of substance to go with the style.

### SKELETON FINGERZ

COLOR	ATV / PWC 7/8"		
Blue	909640	15.99	L



## EZ-THROTTLE™ UNIVERSAL TRIGGER THROTTLE EXTENDER FOR PWC



EZ-Throttle Universal Trigger Throttle Extender works on any model PWC. With EZ-Throttle your trigger is longer making it more comfortable and easier to use.

- Fits Yamaha, Sea-Doo and Kawasaki PWC's with trigger throttles
- Designed to attach to existing finger throttle already on your PWC
- Easy install. No disassembly required of existing throttle
- EZ-Throttle fits over and around existing trigger encasing it between two molded parts forming a smooth, comfortable trigger assembly
- Gives easier speed control for pulling tubes, wakeboards and water skiers
- Enjoy longer rides without hand cramps
- Injection molded plastic specially made for marine use
- Made with Marine grade plastic and stainless steel fasteners
- Does not interfere with full throttle



650400 24.95 Q

- accessories
- towables
- body
- controls
- electrical
- driveline
- engine
- fuel & intake
- chemicals
- tie downs
- tools
- towing & loading



## 699 ATV-JET SKI

- Special Gel compound reduces vibration
- Single density design
- Black
- 7/8"

77-6992 10.95 G



accessories

towables

body

controls

electrical

driveline

engine

fuel & intake

chemicals

tie downs

tools

towing & loading



## 726 ATV-JET SKI

- Durable, grippy GONT compound
- Half-waffle design
- Single density design
- Available in solid colors to match your needs
- 7/8"



COLOR	PART #		
Black	77-7262	10.95	G
Red	77-7266	10.95	G
Blue	77-7267	10.95	G
Gray	77-7268	10.95	G



## 964 EVO ATV-JET SKI

- Bi-compound competition Grips are built to last!
- Ergonomic design molds to your hand so it's easier to hold tight
- Dual density design
- Perfect for sand, rain, or mud
- Extremely comfortable
- 7/8"

COLOR	PART #		
Red/Black	77-9646	16.95	J
Blue/Black	77-9647	16.95	J
Gray/Black	77-9648	16.95	J



MARINE

# CONTROLS

## SLT ATV, PWC, SNOWMOBILE GRIPS



- Firm first layer uses new acoustical rebound core to reflect vibration and improve durability
- Softer outer layer shed mud and water, increase gripping power, reduces vibration for more comfort and less fatigue
- End caps reinforced to improve durability Slim Line SLT specially made for ATV, watercraft, and snowmobile
- These grips have a small flange with a closed end, and are available in 9 colors! Both grips - 7/8"
- Four integrated safety wire grooves
- Sold per pair

COLOR	PART #		
Gray with Black Diamonds	SG2000	16.95	L
Graphite with Black Diamonds	SG2001	16.95	L
Black with Dark Gray Diamonds	SG2002	16.95	L
Green with Black Diamonds	SG2003	16.95	L
Yellow with Black Diamonds	SG2004	16.95	L
Orange with Black Diamonds	SG2005	16.95	L
Red with Black Diamonds	SG2006	16.95	L
Blue with Black Diamonds	SG2007	16.95	L
Pink with Black Diamonds	SG2008	16.95	L



## OURY STANDARD ATV/PWC GRIPS

- 7/8"
- Anti-vibration, large pad design eliminates numbness and slipping
- Extremely soft rubber specially built for ATVs with thumb throttles



COLOR	PART #		
Black	681202	10.95	B
Green	681203	10.95	B
Yellow	681204	10.95	B
Red	681206	10.95	B
Blue	681207	10.95	B
Purple	681209	10.95	B

## OURY SNO/WATER GRIPS

- 7/8"
- No flange design for machines w/thumb throttles
- Proven large pad design
- The best rubber, maximum control and comfort and a great looking grip!



COLOR	PART #		
Clear	682000	10.60	B
White	682001	10.60	B
Black	682002	10.60	B
Green	682003	10.60	B
Yellow	682004	10.60	B
Orange	682005	10.60	B
Red	682006	10.60	B
Blue	682007	10.60	B
Purple	682009	10.60	B

## GRIPLOCK

- A high adhesive specially formulated to keep grips in place without damaging the rubber
- Griplock puts an end to grips twisting or sliding off
- Ideal for motorcycle, personal watercraft, snowmobiles and ATVs



QTY	PART #		
1 oz.	TB1501	10.95	G
10 gm.	TB1505	7.95	G



MARINE





## WSM REVERSE CABLES

- Top-quality cables feature stainless steel fittings and inner vinyl linings
- Built to OEM specifications



MODEL	CC	YEAR	OEM #	PART #	
<b>KAWASAKI</b>					
STS	750	95-97	59406-3737	<b>326037</b>	<b>78.15 L</b>
STX	750	98	59406-3745 59406-3764		
STS	900	01-02	59406-3749	<b>326036</b>	<b>79.95 L</b>
STX	900	97-98	59406-3737 59406-3745 59406-3764	<b>326037</b>	<b>78.15 L</b>
STX	900	99-03	59406-3749	<b>326036</b>	<b>79.95 L</b>
STX	900	04-06	59406-3779	<b>329164</b>	<b>99.95 L</b>
STX	1100	97-99	59406-3749	<b>326036</b>	<b>79.95 L</b>
STX DI	1100	00-03			
STX-12F	1200	03			
STX-12F	1200	04-07	59406-3779	<b>329164</b>	<b>99.95 L</b>
STX-15F	1500	04-15			
Ultra 250X	1500	07-08	59406-3781	<b>329165</b>	<b>99.95 L</b>
Ultra 260LX	1500	09			
Ultra 260LX	1500	10	59406-3786	<b>329166</b>	<b>124.95 L</b>
Ultra 260X	1500	09	59406-3781	<b>329165</b>	<b>99.95 L</b>
Ultra 260X	1500	10	59406-3786	<b>329166</b>	<b>124.95 L</b>
Ultra 300LX	1500	11-13			
Ultra 300X	1500	11-13			
Ultra 310LX	1500	14-15			
Ultra 310R	1500	14-15			
Ultra 310X	1500	14-15			
Ultra 310X SE	1500	14-15			
Ultra LX	1500	07-09	59406-3781	<b>329165</b>	<b>99.95 L</b>
Ultra LX	1500	10-15	59406-3786	<b>329166</b>	<b>124.95 L</b>
<b>SEA-DOO</b>					
GT	580	90-91	277000228	<b>326053</b>	<b>83.45 L</b>
GTS	580	92-93			
GTS	580	94-96	277000249	<b>326063</b>	<b>99.95 L</b>
GTX	580	92-93	277000228	<b>326053</b>	<b>83.45 L</b>
SP	580	89-93			
SPI	580	93			
SPX	580	93			
XP	580	91-92			
GTX	650	94-95	277000249	<b>326063</b>	<b>99.95 L</b>
GTI	720	96			
GTI	720	97-98	277000552	<b>326061</b>	<b>111.85 L</b>
GTI	720	99-00	277000725	<b>326064</b>	<b>108.50 L</b>
GTI	720	01-05	268000017 277000017 277000944	<b>329002</b>	<b>99.95 L</b>
GTS	720	97-00	277000249	<b>326063</b>	<b>99.95 L</b>
GTS	720	01	268000017 277000017 277000944	<b>329002</b>	<b>99.95 L</b>

MODEL	CC	YEAR	OEM #	PART #	
<b>SEA-DOO CONTINUED</b>					
HX	720	95-97	268000017	<b>329002</b>	<b>99.95 L</b>
GTI LE RFI	800	03-05	277000017 277000944		
GTI RFI	800	04-05	268000017 277000017 277000944	<b>329002</b>	<b>99.95 L</b>
GTX	800	96-97	277000552	<b>326061</b>	<b>111.85 L</b>
GTX RFI	800	98-02	277000725	<b>326064</b>	<b>108.50 L</b>
GTX DI	951	02-03	268000030 277000948	<b>329003</b>	<b>99.95 L</b>
GTI	1503	06-07	268000017 277000017 277000944	<b>329002</b>	<b>99.95 L</b>
GTI / SE 130	1503	08-10	268000017 277000017 277000944	<b>329002</b>	<b>99.95 L</b>
GTI Rental	1503	06-07	268000017 277000017 277000944	<b>329002</b>	<b>99.95 L</b>
GTI Rental 130	1503	08-10	268000017 277000017 277000944	<b>329002</b>	<b>99.95 L</b>
GTI SE	1503	06-07	268000017 277000017 277000944	<b>329002</b>	<b>99.95 L</b>
GTI SE 155	1503	08-10	268000017 277000017 277000944	<b>329002</b>	<b>99.95 L</b>
GTI Wake 155	1503	08	268000030 277000948	<b>329003</b>	<b>99.95 L</b>
GTI Wake 155	1503	09-10	268000017	<b>329002</b>	<b>99.95 L</b>
GTS Pro 130	1503	11	277000017 277000944		
GTX	1503	02-07	268000030 277000948	<b>329003</b>	<b>99.95 L</b>
GTX 155	1503	08-09	268000030 277000948	<b>329003</b>	<b>99.95 L</b>
GTX LTD S.C. 185	1503	03-04	268000030 277000948	<b>329003</b>	<b>99.95 L</b>
GTX LTD S.C. 215	1503	05-08	268000030 277000948	<b>329003</b>	<b>99.95 L</b>
GTX S.C. 185	1503	03-06	268000030 277000948	<b>329003</b>	<b>99.95 L</b>
GTX S.C. 215	1503	08-09	268000030 277000948	<b>329003</b>	<b>99.95 L</b>

- accessories
- towables
- body
- controls
- electrical
- driveline
- engine
- fuel & intake
- chemicals
- tie downs
- tools
- towing & loading

MARINE

## WSM REVERSE CABLES CONTINUED

- accessories
- towables
- body
- controls
- electrical
- driveline
- engine
- fuel & intake
- chemicals
- tie downs
- tools
- towing & loading

MARINE

MODEL	CC	YEAR	OEM #	PART #
<b>KAWASAKI CONTINUED</b>				
GTX Wake	1503	03-07	268000030 277000948	<b>329003 99.95 L</b>
GTX Wake Pro 215	1503	09	268000030 277000948	<b>329003 99.95 L</b>
GTX Wake S.C. 215	1503	07-08	268000030 277000948	<b>329003 99.95 L</b>
RXP S.C. 215 S.C. = Super Charged	1503	09	268000017 277000017 277000944	<b>329002 99.95 L</b>
RXP X 255	1503	09-11	268000017 277000017 277000944	<b>329002 99.95 L</b>
RXT S.C. 215	1503	05-09	268000030 277000948	<b>329003 99.95 L</b>
RXT X 255 S.C. = Super Charged	1503	08-09	268000030 277000948	<b>329003 99.95 L</b>
<b>YAMAHA</b>				
Wave Runner III	650	90-93	GA9-U149C-00-00	<b>326095 70.10 L</b>
Wave Runner III	700	94-95	GA9-U149C-01-00	
Wave Venture	700	95-96	GJ3-U149C-00-00	<b>326099 133.60 L</b>
Wave Venture	760	97	GP3-U149C-00-00	<b>326098 86.80 L</b>
XL	760	98-99	GP3-U149C-01-00	
GP-R	800	04	F0D-U149C-00-00	<b>326096 70.10 L</b>
XL	800	00-01	F0V-U149C-00-00	
XLT	800	02-03		
FX	1000	05-07	F1B-6149C-01-00 F1B-6149C-02-00	<b>329187 139.95 L</b>
FX	1000	08	F1W-6149C-00-00 F1W-6149C-01-00	<b>329189 139.95 L</b>
FX 140	1000	02-04	F1B-6149C-01-00	<b>329187 139.95 L</b>
FX Cruiser	1000	03-07	F1B-6149C-02-00	
FX Cruiser	1000	08	F1W-6149C-00-00 F1W-6149C-01-00	<b>329189 139.95 L</b>
FX Cruiser HO	1100	04-07	F1B-6149C-01-00	<b>329187 139.95 L</b>
FX HO	1100	04-07	F1B-6149C-02-00	
VX Cruiser	1100	07-09	F1K-6149C-00-00	<b>329188 139.95 L</b>

MODEL	CC	YEAR	OEM #	PART #
<b>YAMAHA CONTINUED</b>				
VX Cruiser	1100	10-12	F2N-6149C-00-00	<b>329191 142.95 L</b>
VX Deluxe	1100	05-09	F1K-6149C-00-00	<b>329188 139.95 L</b>
VX Deluxe	1100	10-12	F2N-6149C-00-00	<b>329191 142.95 L</b>
VX Sport	1100	05-06	F1K-6149C-00-00	<b>329188 139.95 L</b>
Wave Venture	1100	96-97	GH3-U149C-00-00	<b>326097 81.75 L</b>
SUV	1200	99-04		<b>329186 129.95 L</b>
XL	1200	98	GP3-U149C-00-00 GP3-U149C-01-00	<b>326098 86.80 L</b>
XL LTD	1200	99-00	F0D-U149C-00-00	<b>326096 70.10 L</b>
XLT	1200	01-05	F0V-U149C-00-00	
FX Cruiser HO	1800	09-10	F1W-6149C-00-00 F1W-6149C-01-00	<b>329189 139.95 L</b>
FX Cruiser HO	1800	11	F1W-6149C-10-00	<b>329192 149.95 J</b>
FX Cruiser SHO	1800	08-10	F1W-6149C-00-00 F1W-6149C-01-00	<b>329189 139.95 L</b>
FX Cruiser SHO	1800	11	F1W-6149C-10-00	<b>329192 149.95 J</b>
FX HO	1800	09-10	F1W-6149C-00-00 F1W-6149C-01-00	<b>329189 139.95 L</b>
FX HO	1800	11	F1W-6149C-10-00	<b>329192 149.95 J</b>
FX SHO	1800	08-10	F1W-6149C-00-00 F1W-6149C-01-00	<b>329189 139.95 L</b>
FX SHO	1800	11	F1W-6149C-10-00	<b>329192 149.95 J</b>
FZR	1800	09-10	F2C-6149C-00-00	<b>329190 229.95 J</b>
FZR	1800	11-15	F2C-6149C-10-00	<b>329193 227.95 J</b>
FZS	1800	09-10	F2C-6149C-00-00	<b>329190 229.95 J</b>
FZS	1800	11-15	F2C-6149C-10-00	<b>329193 227.95 J</b>
VXR	1800	11-12	F2N-6149C-00-00	<b>329191 142.95 L</b>
VXS	1800	11-12		

## WSM THROTTLE CABLES

- Top-quality cables feature stainless steel fittings and inner vinyl linings
- Built to OEM specifications



MODEL	CC	YEAR	OEM #	PART #		
<b>KAWASAKI</b>						
JS	440	77-86	54012-3001	<b>326106</b>	<b>41.65</b>	L
JS	550	82-86				
SX	550	91-95	54012-3725	<b>326004</b>	<b>35.00</b>	L
SX	650	88-90	54012-3706	<b>326109</b>	<b>50.90</b>	L
			54012-3711			
SX	650	91-93	54012-3727	<b>326000</b>	<b>36.70</b>	N
			54012-3731			
TS	650	89-90	54012-3719	<b>326002</b>	<b>24.95</b>	L
TS	650	91-95	54012-3733	<b>326014</b>	<b>24.95</b>	L
X2	650	86-87	54012-3704	<b>326107</b>	<b>33.25</b>	L
X2	650	91-95	54012-3728	<b>326006</b>	<b>25.00</b>	L
SSXI	750	93-95	54012-3738	<b>326001</b>	<b>24.95</b>	L
SSXI	750	96-97	54012-3744	<b>326010</b>	<b>24.95</b>	L
STS	750	95-97				
STX	750	98				
SX	750	92-95	54012-3732	<b>326009</b>	<b>30.50</b>	L
SXi	750	95	54012-3743	<b>326003</b>	<b>31.30</b>	L
SXi	750	96	54012-3748	<b>326005</b>	<b>32.80</b>	L
SXi Pro	750	98-02	54012-3753			
Xi Sport	750	98-99	54012-3744	<b>326010</b>	<b>24.95</b>	L
ZXi	750	95-97	54012-3747	<b>326007</b>	<b>24.95</b>	L
			54012-3754			
SX-R	800	03-11	54012-3773	<b>329154</b>	<b>24.95</b>	H
STS	900	01-02	54012-3756	<b>326011</b>	<b>24.95</b>	L
STX	900	97-98	54012-3744	<b>326010</b>	<b>24.95</b>	L
STX	900	99-03	54012-3756	<b>326011</b>	<b>24.95</b>	L
STX	900	04-06	54012-3769	<b>326013</b>	<b>59.95</b>	L
ZXi	900	95-97	54012-3747	<b>326007</b>	<b>24.95</b>	L
			54012-3754			
STX	1100	98	54012-3756	<b>326011</b>	<b>24.95</b>	L
STX DI	1100	00-02	54012-3765	<b>326012</b>	<b>75.10</b>	L
STX DI	1100	03	54012-3769	<b>326013</b>	<b>59.95</b>	L
Ultra 130 DI	1100	01-02	54012-3767	<b>326123</b>	<b>64.95</b>	L
Ultra 130 DI	1100	03-04	54012-3770	<b>326121</b>	<b>64.95</b>	L
ZXi	1100	96-97	54012-3747	<b>326007</b>	<b>24.95</b>	L
			54012-3754			
ZXi	1100	98-03	54012-3758	<b>326008</b>	<b>31.50</b>	L
STX-12F	1200	03-07	54012-3771	<b>329155</b>	<b>64.95</b>	L
STX-R	1200	02-04	54012-3768	<b>326122</b>	<b>59.95</b>	L
Ultra 150	1200	99-02	54012-3764	<b>326124</b>	<b>37.95</b>	L
Ultra 150	1200	03-05	54012-3768	<b>326122</b>	<b>59.95</b>	L
STX	1500	09-10	54012-3771	<b>329155</b>	<b>64.95</b>	L
STX-15F	1500	04-15				
Ultra 250X	1500	07-08				
Ultra 260LX	1500	09-10				
Ultra 260X	1500	09-10				

MODEL	CC	YEAR	OEM #	PART #		
<b>KAWASAKI CONTINUED</b>						
Ultra 300LX	1500	11-13	54012-0592	<b>329156</b>	<b>34.99</b>	L
Ultra 300X	1500	11-13	54012-3777			
Ultra 310LX	1500	14-15				
Ultra 310R	1500	14-15				
Ultra 310X	1500	14-15				
Ultra 310X SE	1500	14-15				
Ultra LX	1500	07-15	54012-3771	<b>329155</b>	<b>64.95</b>	L
<b>POLARIS</b>						
SL	650	92-95	7080449	<b>326116</b>	<b>33.35</b>	L
Freedom	700	02-04	7081065	<b>326080</b>	<b>39.95</b>	L
Virage	700	02-04				
SL	750	93-95	7080449	<b>326116</b>	<b>33.35</b>	L
<b>SEA-DOO</b>						
GTS	580	92-93	277000137	<b>326019</b>	<b>31.95</b>	L
GTS	580	94-95	277000271	<b>326026</b>	<b>37.75</b>	L
GTX	580	92-93	277000137	<b>326019</b>	<b>31.95</b>	L
SP	580	92-93				
SP	580	94-96	277000252	<b>326027</b>	<b>49.95</b>	L
SPI	580	93	277000137	<b>326019</b>	<b>31.95</b>	L
SPI	580	94-96	277000252	<b>326027</b>	<b>49.95</b>	L
SPX	580	93	277000137	<b>326019</b>	<b>31.95</b>	L
XP	580	92				
GTX	650	94-95	277000271	<b>326026</b>	<b>37.75</b>	L
SPX	650	94	277000275	<b>326020</b>	<b>37.75</b>	L
SPX	650	95	277000253	<b>326030</b>	<b>49.95</b>	L
XP	650	94				
XPI	650	94	277000275	<b>326020</b>	<b>37.75</b>	L
GS	720	97	277000614	<b>326021</b>	<b>49.95</b>	L
GS	720	98-01	277000727	<b>326022</b>	<b>39.95</b>	L
GSI	720	97	277000614	<b>326021</b>	<b>49.95</b>	L
GTI	720	97				
GTI	720	98-01	277000727	<b>326022</b>	<b>39.95</b>	L
GTS	720	97	277000649	<b>326023</b>	<b>49.95</b>	L
GTS	720	98-00	277000710	<b>326024</b>	<b>29.95</b>	L
GTS	720	01	277000727	<b>326022</b>	<b>39.95</b>	L
SP	720	97	277000252	<b>326027</b>	<b>49.95</b>	L
SPX	720	96	277000468	<b>326028</b>	<b>37.95</b>	L
GSX	800	96-97	277000596	<b>326029</b>	<b>49.95</b>	L
GTI LE RFI	800	03-05	277000847	<b>326016</b>	<b>44.35</b>	L
GTI RFI	800	04-05				
GTX RFI	800	99-02				
SPX	800	97-99	277000468	<b>326028</b>	<b>37.95</b>	L
XP	800	95-96				

- accessories
- towables
- body
- controls
- electrical
- driveline
- engine
- fuel & intake
- chemicals
- tie downs
- tools
- towing & loading

# MARINE

## WSM THROTTLE CABLES CONTINUED

- accessories
- towables
- body
- controls**
- electrical
- driveline
- engine
- fuel & intake
- chemicals
- tie downs
- tools
- towing & loading

MARINE

MODEL	CC	YEAR	OEM #	PART #	
<b>SEA-DOO CONTINUED</b>					
GSX	951	98	277000781	<b>326015</b>	<b>49.95</b> L
GSX LTD Old Style	951	99	277000892	<b>329593</b>	<b>149.95</b> L
GSX LTD	951	99	277000915	<b>329594</b>	<b>99.95</b> L
GTX Old Style	951	00-02	277000892	<b>329593</b>	<b>149.95</b> L
GTX DI	951	00-03	277000851	<b>326017</b>	<b>49.95</b> L
GTX LTD	951	98	277000781	<b>326015</b>	<b>49.95</b> L
GTX LTD	951	99	277000915	<b>329594</b>	<b>99.95</b> L
GTX LTD Old Style	951	99	277000892	<b>329593</b>	<b>149.95</b> L
LRV	951	00	277000915	<b>329594</b>	<b>99.95</b> L
LRV Old Style	951	00	277000892	<b>329593</b>	<b>149.95</b> L
RX	951	00-02	277000915	<b>329594</b>	<b>99.95</b> L
RX DI	951	00-03	277000851	<b>326017</b>	<b>49.95</b> L
GTI	1503	06-07	277001083	<b>329157</b>	<b>49.95</b> L
GTI SE 155	1503	10	277001122		
GTI Wake 155	1503	09-10	277001170		
GTS Pro 130	1503	11			
GTX	1503	03-07			
GTX 155	1503	08-10			
GTX LTD S.C. 185	1503	03-04	277001121	<b>329158</b>	<b>49.95</b> L
GTX LTD S.C. 215	1503	05-08			
GTX S.C. 185	1503	03-06			
GTX S.C. 215	1503	08-09			
GTX Wake	1503	08	277001083 277001122 277001170	<b>329157</b>	<b>49.95</b> L
GTX Wake Pro 215	1503	09	277001121	<b>329158</b>	<b>49.95</b> L
GTX Wake S.C. 215	1503	07-08			
RXP S.C. 215	1503	04-09	277001070	<b>329159</b>	<b>49.95</b> L
RXT S.C. 215	1503	05-09	277001121	<b>329158</b>	<b>49.95</b> L
S.C. = Super Charged					
<b>YAMAHA</b>					
Wave Jammer	500	89-90	EW3-67252- 01-00 EW3-67252- 02-00	<b>326075</b>	<b>65.15</b> L

MODEL	CC	YEAR	OEM #	PART #	
<b>YAMAHA CONTINUED</b>					
Wave Runner	500	89	EU0-U7252- 00-00	<b>326081</b>	<b>45.60</b> L
Wave Runner LX	500	91-93	EU0-U7252- 01-00		
Super Jet	650	91-93			
VXR	650	91-95			
Wave Runner III	650	90-93			
Wave Runner III FX1	650	95-96			
Super Jet	700	94-95			
Super Jet	700	95			
Super Jet	700	96-15	GM6-67252- 00-00	<b>326087</b>	<b>80.60</b> L
Wave Blaster	700	93-95	EU0-U7252- 00-00 EU0-U7252- 01-00	<b>326081</b>	<b>45.60</b> L
Wave Blaster	700	96	GH1-67252- 00-00	<b>326078</b>	<b>50.90</b> L
Wave Raider	700	94	GH1-67252- 01-00		
Wave Raider	700	95	GJ1-U7252- 00-00	<b>326092</b>	<b>40.00</b> L
Wave Raider	700	96-97	EU0-U7252- 00-00 EU0-U7252- 01-00	<b>326081</b>	<b>45.60</b> L
Wave Raider Deluxe	700	95	GJ1-U7252- 00-00	<b>326092</b>	<b>40.00</b> L
Wave Runner III	700	94-95	EU0-U7252- 00-00	<b>326081</b>	<b>45.60</b> L
Wave Runner III	700	97	EU0-U7252- 01-00		
Wave Venture	700	95-96	GJ1-U7252- 00-00	<b>326092</b>	<b>40.00</b> L
Wave Venture	700	98			
XL	700	99-04	F0M-U7252- 00-00	<b>326086</b>	<b>47.55</b> L
GP	760	99-00	GP7-U7252- 00-00	<b>326079</b>	<b>36.10</b> L
Wave Raider	760	96	GP2-U7252- 00-00	<b>326088</b>	<b>57.80</b> L
Wave Runner	760	97-98	GP7-U7252- 00-00	<b>326079</b>	<b>36.10</b> L
Wave Venture	760	97	GP2-U7252- 00-00	<b>326088</b>	<b>57.80</b> L
XL	760	98-99			
GP	800	98-00	66E-67252- 00-00	<b>326083</b>	<b>60.70</b> L
GP	800	01-02	68A-67252- 00-00	<b>326085</b>	<b>66.45</b> L
GP-R	800	03-05			
XL	800	00-01	66E-67252- 00-00	<b>326083</b>	<b>60.70</b> L
XLT	800	02-03			

## WSM THROTTLE CABLES CONTINUED

MODEL	CC	YEAR	OEM #	PART #		
<b>YAMAHA CONTINUED</b>						
FX	1000	05	6B6-26311-00-00	<b>329181</b>	<b>64.95</b>	L
			6B6-26311-02-00			
FX	1000	06-08	6B6-26311-11-00	<b>329182</b>	<b>64.95</b>	L
			6B6-26311-12-00			
FX 140	1000	02-04	60E-26311-00-00	<b>326082</b>	<b>60.70</b>	L
FX Cruiser	1000	05	6B6-26311-00-00	<b>329181</b>	<b>64.95</b>	L
			6B6-26311-02-00			
FX Cruiser	1000	06-08	6B6-26311-11-00	<b>329182</b>	<b>64.95</b>	L
			6B6-26311-12-00			
FX Cruiser HO	1100	04-05	6B6-26311-00-00	<b>329181</b>	<b>64.95</b>	L
			6B6-26311-02-00			
FX Cruiser HO	1100	06-08	6B6-26311-11-00	<b>329182</b>	<b>64.95</b>	L
			6B6-26311-12-00			
FX HO	1100	04-05	6B6-26311-00-00	<b>329181</b>	<b>64.95</b>	L
			6B6-26311-02-00			
FX HO	1100	06-08	6B6-26311-11-00	<b>329182</b>	<b>64.95</b>	L
			6B6-26311-12-00			

MODEL	CC	YEAR	OEM #	PART #		
<b>YAMAHA CONTINUED</b>						
VX	1100	07-09	6D3-26311-00-00	<b>329183</b>	<b>39.95</b>	L
VX Cruiser	1100	07-09	6D3-26311-01-00			
VX Deluxe	1100	05-09	6D3-26311-02-00			
VX Sport	1100	05-09				
Wave Raider	1100	95-96	GJ1-U7252-00-00	<b>326092</b>	<b>40.00</b>	L
Wave Venture	1100	96-97				
GP	1200	97-99	GP8-U7252-00-00	<b>326089</b>	<b>60.90</b>	L
GP	1200	00-02	66V-67252-00-00	<b>326084</b>	<b>60.70</b>	L
SUV	1200	99-04	F1D-67252-00-00	<b>326090</b>	<b>29.95</b>	W
			GU5-U7252-00-00			
XL	1200	98	GP8-U7252-00-00	<b>326089</b>	<b>60.90</b>	L
XL LTD	1200	99-00	66V-67252-00-00	<b>326084</b>	<b>60.70</b>	L
XLT	1200	01-05				
GP-R	1300	03-08	60T-67252-00-00	<b>326091</b>	<b>83.45</b>	L
			60T-67252-01-00			
FX Cruiser HO	1800	09-11	6S5-26311-10-00	<b>329185</b>	<b>50.95</b>	L
FX Cruiser SHO	1800	08-11				
FX HO	1800	09-11				
FX SHO	1800	08-11				
FZR	1800	09-15	6AN-26311-00-00	<b>329184</b>	<b>50.95</b>	L
FZS	1800	09-15				

accessories

towables

body

**controls**

electrical

driveline

engine

fuel & intake

chemicals

tie downs

tools

towing & loading

**MARINE**

# CONTROLS

## WSM STEERING CABLES



- Top-quality cables feature stainless steel fittings and inner vinyl linings
- Built to OEM specifications

- accessories
- towables
- body
- controls
- electrical
- driveline
- engine
- fuel & intake
- chemicals
- tie downs
- tools
- towing & loading

MARINE

MODEL	CC	YEAR	OEM #	PART #	
<b>KAWASAKI</b>					
JS	300	86-88	59406-3001	<b>326110</b>	<b>99.95 L</b>
JS	400	76	59406-3709		
JS	440	77-87			
JS	550	82-87			
SX	550	90-95			
SC	650	91-95	59406-3724	<b>326115</b>	<b>42.95 L</b>
SX	650	87-90	59406-3705 59406-3708	<b>326113</b>	<b>92.95 L</b>
X2	650	86-87	59406-3723	<b>326111</b>	<b>73.65 L</b>
X2	650	88	59406-3712	<b>326112</b>	<b>64.90 L</b>
X2	650	90			
SS	750	92-97	59406-3728	<b>326045</b>	<b>70.60 L</b>
SSXI	750	93-97	59406-3732	<b>326044</b>	<b>34.95 L</b>
STS	750	95-97	59406-3736	<b>326039</b>	<b>69.95 L</b>
STX	750	98			
SX	750	92-95	59406-3726	<b>326034</b>	<b>71.00 L</b>
SXi	750	95-96			
SXi Pro	750	98-02			
Xi Sport	750	98-99	59406-3728	<b>326045</b>	<b>70.60 L</b>
ZXi	750	95-97	59406-3742 59406-3746	<b>326040</b>	<b>88.45 L</b>
SX-R	800	03-11	59406-3776	<b>329162</b>	<b>69.95 L</b>
STS	900	01-02	59406-3748	<b>326041</b>	<b>74.95 L</b>
STX	900	98	59406-3736	<b>326039</b>	<b>69.95 L</b>
STX	900	99-02	59406-3748	<b>326041</b>	<b>74.95 L</b>
STX	900	03-06	59406-3778	<b>326033</b>	<b>74.95 L</b>
ZXi	900	95-97	59406-3742 59406-3746	<b>326040</b>	<b>88.45 L</b>
STX	1100	97-99	59406-3748	<b>326041</b>	<b>74.95 L</b>
STX DI	1100	00-02			
STX DI	1100	03	59406-3778	<b>326033</b>	<b>74.95 L</b>
Ultra 130 DI	1100	01-04	59406-3771	<b>326042</b>	<b>64.95 L</b>
ZXi	1100	96-03	59406-3755 59406-3757	<b>326032</b>	<b>69.95 L</b>
STX-12F	1200	03-07	59406-3778	<b>326033</b>	<b>74.95 L</b>
STX-R	1200	02-03	59406-3748	<b>326041</b>	<b>74.95 L</b>
STX-R	1200	04-05	59406-3778	<b>326033</b>	<b>74.95 L</b>
Ultra 150	1200	99-05	59406-3771	<b>326042</b>	<b>64.95 L</b>
STX-15F	1500	04-15	59406-3778	<b>326033</b>	<b>74.95 L</b>
Ultra 250X	1500	07-08	59406-3780	<b>329163</b>	<b>84.95 J</b>
Ultra 260LX	1500	09			
Ultra 260LX	1500	10	59406-0003 59406-3785	<b>329161</b>	<b>82.95 E</b>
Ultra 260X	1500	09	59406-3780	<b>329163</b>	<b>84.95 J</b>
Ultra 260X	1500	10	59406-0003	<b>329161</b>	<b>82.95 E</b>
Ultra 300LX	1500	11-13	59406-3785		
Ultra 300X	1500	11-13			
Ultra 310LX	1500	14-15			
Ultra 310R	1500	14-15			
Ultra 310X	1500	14-15			
Ultra 310X SE	1500	14-15			

MODEL	CC	YEAR	OEM #	PART #	
<b>KAWASAKI CONTINUED</b>					
Ultra LX	1500	07-09	59406-3780	<b>329163</b>	<b>84.95 J</b>
Ultra LX	1500	10-15	59406-0003	<b>329161</b>	<b>82.95 E</b>
<b>POLARIS</b>					
Freedom	700	02	7080723 7081079	<b>326117</b>	<b>153.65 L</b>
Freedom	700	03-04	7081080	<b>326118</b>	<b>99.95 L</b>
SLTH	700	98-99	7080723	<b>326117</b>	<b>153.65 L</b>
Virage	700	00-02	7081079		
Virage	700	03-04	7081080	<b>326118</b>	<b>99.95 L</b>
MSX 150	750	04			
SLTX	1050	98-99	7080723 7081079	<b>326117</b>	<b>153.65 L</b>
MSX 140	1200	03-04	7081080	<b>326118</b>	<b>99.95 L</b>
Virage TX	1200	00-02	7080723	<b>326117</b>	<b>153.65 L</b>
Virage Txi	1200	01-02	7081079		
<b>SEA-DOO</b>					
<b>326052</b>			<b>326057</b>		
<b>NO ADJUSTABLE NUT</b>			<b>HAS ADJUSTABLE NUT</b>		
GT	580	90-91	271000436 277000367	<b>326048</b>	<b>105.15 L</b>
GT	580	90-91	277000152	<b>326046</b>	<b>83.42 L</b>
GTS	580	92			
OldStyle					
GTS	580	92-95	271000436 277000367	<b>326048</b>	<b>105.15 L</b>
GTS	580	94	277000261	<b>326047</b>	<b>113.50 L</b>
OldStyle					
GTX	580	92	277000152	<b>326046</b>	<b>83.42 L</b>
OldStyle					
GTX	580	92-93	271000436 277000367	<b>326048</b>	<b>105.15 L</b>
SP	580	94-96	277000289	<b>326065</b>	<b>91.80 L</b>
SPI	580	94-96			
GTX	650	94	277000261	<b>326047</b>	<b>113.50 L</b>
OldStyle					
GTX	650	94-95	271000436 277000367	<b>326048</b>	<b>105.15 L</b>
SPX	650	94-95	277000289	<b>326065</b>	<b>91.80 L</b>
XP	650	94			
XP	650	95	277000467	<b>326066</b>	<b>166.60 L</b>
XPI	650	94	277000289	<b>326065</b>	<b>91.80 L</b>
GS	720	97-01	271000436	<b>326048</b>	<b>105.15 L</b>
GSI	720	97	277000367		
GTI	720	97-01	277000526	<b>326051</b>	<b>111.85 L</b>

## WSM STEERING CABLES CONTINUED

MODEL	CC	YEAR	OEM #	PART #	
<b>SEA-DOO CONTINUED</b>					
<b>326052 NO ADJUSTABLE NUT</b>			<b>326057 HAS ADJUSTABLE NUT</b>		
GTI	720	01-04	277000843 277001010 277001322 277001474 277001532 277001580	<b>326057</b>	<b>141.90 L</b>
GTI	720	01-04	277001010 277001474 277001580	<b>326052</b>	<b>138.55 L</b>
GTI LE	720	02-04	277000843 277001010 277001322 277001474 277001532 277001580	<b>326057</b>	<b>141.90 L</b>
GTI LE	720	02-04	277001010 277001474 277001580	<b>326052</b>	<b>138.55 L</b>
GTS	720	97-00	271000436 277000367	<b>326048</b>	<b>105.15 L</b>
GTS	720	01	277001010 277001474 277001580	<b>326052</b>	<b>138.55 L</b>
GTS	720	01	277000843 277001010 277001322 277001474 277001532 277001580	<b>326057</b>	<b>141.90 L</b>
SP	720	977	277000289	<b>326065</b>	<b>91.80 L</b>
SPX	720	96			
GSX	800	96-97	271000436 277000367	<b>326048</b>	<b>105.15 L</b>
GSX RFI	800	00	277000841 277001321	<b>326055</b>	<b>119.95 L</b>
GTI LE RFI	800	03-04	277000843 277001010 277001322 277001474 277001532 277001580	<b>326057</b>	<b>141.90 L</b>
GTI LE RFI	800	03-04	277001010 277001474 277001580	<b>326052</b>	<b>138.55 L</b>
GTI RFI	800	04	277000843 277001010 277001322 277001474 277001532 277001580	<b>326057</b>	<b>141.90 L</b>
GTI RFI	800	04	277001010 277001474 277001580	<b>326052</b>	<b>138.55 L</b>

MODEL	CC	YEAR	OEM #	PART #	
<b>SEA-DOO CONTINUED</b>					
<b>326052 NO ADJUSTABLE NUT</b>			<b>326057 HAS ADJUSTABLE NUT</b>		
GTX	800	96-97	277000526	<b>326051</b>	<b>111.85 L</b>
GTX RFI	800	99-00	277000842 277001323	<b>326056</b>	<b>150.25 L</b>
SPX	800	97-99	277000289	<b>326065</b>	<b>91.80 L</b>
XP	800	96			
GSX LTD	951	98	271000436 277000367	<b>326048</b>	<b>105.15 L</b>
GTX	951	00	277000843 277001010 277001322 277001474 277001532 277001580	<b>326057</b>	<b>141.90 L</b>
GTX	951	01-02	277001010 277001474 277001580	<b>326052</b>	<b>138.55 L</b>
GTX DI	951	00	277000842 277001323	<b>326056</b>	<b>150.25 L</b>
GTX DI	951	02-03	277001326 277001438 277001555 277001578	<b>326058</b>	<b>158.60 L</b>
GTX LTD	951	98	277000526	<b>326051</b>	<b>111.85 L</b>
GTX LTD	951	99	277000843 277001010 277001322 277001474 277001532 277001580	<b>326057</b>	<b>141.90 L</b>
RX	951	00	277000841 277001321	<b>326055</b>	<b>119.95 L</b>
RX	951	01-02	277001011 277001321	<b>326050</b>	<b>139.95 H</b>
RX DI	951	00	277000841 277001321	<b>326055</b>	<b>119.95 L</b>
RX DI	951	01-03	277001011 277001321	<b>326050</b>	<b>139.95 H</b>
XP	951	01-02	277001008	<b>326054</b>	<b>140.20 L</b>
XP DI	951	03-04	277001324		
XP LTD	951	98-99			
GTI	1503	06-07	277001010 277001474	<b>326052</b>	<b>138.55 L</b>
GTI	1503	06-07	277000843 277001010 277001322 277001474 277001532 277001580	<b>326057</b>	<b>141.90 L</b>
GTI / SE 130	1503	08-10	277001010 277001474 277001580	<b>326052</b>	<b>138.55 L</b>

accessories

towables

body

controls

electrical

driveline

engine

fuel & intake

chemicals

tie downs

tools

towing & loading

MARINE

## WSM STEERING CABLES CONTINUED

- accessories
- towables
- body
- controls**
- electrical
- driveline
- engine
- fuel & intake
- chemicals
- tie downs
- tools
- towing & loading

# MARINE

MODEL	CC	YEAR	OEM #	PART #	
<b>SEA-DOO CONTINUED</b>					
<b>326052 NO ADJUSTABLE NUT</b>			<b>326057 HAS ADJUSTABLE NUT</b>		
GTI / SE 130	1503	08-10	277000843 277001010 277001322 277001474 277001532 277001580	<b>326057</b>	<b>141.90 L</b>
GTI / SE 130	1503	11-14	277001326	<b>326058</b>	<b>158.60 L</b>
GTI LTD	1503	14	277001438		
GTI LTD 155	1503	11-13	277001555 277001578		
GTI Rental	1503	06-07	277001010 277001474 277001580	<b>326052</b>	<b>138.55 L</b>
GTI Rental	1503	06-07	277000843 277001010 277001322 277001474 277001532 277001580	<b>326057</b>	<b>141.90 L</b>
GTI Rental 130	1503	08-10	277001010 277001474 277001580	<b>326052</b>	<b>138.55 L</b>
GTI Rental 130	1503	08-10	277000843 277001010 277001322 277001474 277001532 277001580	<b>326057</b>	<b>141.90 L</b>
GTI SE	1503	06-07	277001010 277001474 277001580	<b>326052</b>	<b>138.55 L</b>
GTI SE	1503	06-07	277000843 277001010 277001322 277001474 277001532 277001580	<b>326057</b>	<b>141.90 L</b>
GTI SE 155	1503	08-10	277001010 277001474 277001580	<b>326052</b>	<b>138.55 L</b>
GTI SE 155	1503	08-10	277000843 277001010 277001322 277001474 277001532 277001580	<b>326057</b>	<b>141.90 L</b>
GTI SE 155	1503	11-14	277001326	<b>326058</b>	<b>158.60 L</b>
GTI Wake 155	1503	08	277001438 277001555 277001578		

MODEL	CC	YEAR	OEM #	PART #	
<b>SEA-DOO CONTINUED</b>					
<b>326052 NO ADJUSTABLE NUT</b>			<b>326057 HAS ADJUSTABLE NUT</b>		
GTI Wake 155	1503	09-10	277001010 277001474 277001580	<b>326052</b>	<b>138.55 L</b>
GTI Wake 155	1503	09-10	277000843 277001010 277001322 277001474 277001532 277001580	<b>326057</b>	<b>141.90 L</b>
GTI Wake 155	1503	11-14	277001326	<b>326058</b>	<b>158.60 L</b>
GTR 215	1503	12-14	277001438		
GTS 130	1503	11-14	277001555 277001578		
GTS Pro 130	1503	11	277001010 277001474 277001580	<b>326052</b>	<b>138.55 L</b>
GTS Pro 130	1503	11	277000843 277001010 277001322 277001474 277001532 277001580	<b>326057</b>	<b>141.90 L</b>
GTS Rental 130	1503	11-13	277001326	<b>326058</b>	<b>158.60 L</b>
GTX	1503	02-07	277001438		
GTX 155	1503	08-09	277001555 277001578		
GTX 155	1503	10-14	277001602 277001699	<b>329167</b>	<b>104.95 L</b>
GTX LTD S.C. 185	1503	03-04	277001326	<b>326058</b>	<b>158.60 L</b>
GTX LTD S.C. 215	1503	05-08	277001438 277001555 277001578		
GTX LTD S.C. 215	1503	14	277001602	<b>329167</b>	<b>104.95 L</b>
GTX LTD S.C. 255	1503	09	277001699		
GTX LTD S.C. 260	1503	10-14			
GTX S.C. 185	1503	03-06	277001326	<b>326058</b>	<b>158.60 L</b>
GTX S.C. 215	1503	08-09	277001438 277001555 277001578		
GTX S.C. 215	1503	10-13	277001602 277001699	<b>329167</b>	<b>104.95 L</b>



## WSM STEERING CABLES CONTINUED

MODEL	CC	YEAR	OEM #	PART #	
<b>SEA-DOO CONTINUED</b>					
<b>326052 NO ADJUSTABLE NUT</b>			<b>326057 HAS ADJUSTABLE NUT</b>		
GTX Wake	1503	03-07	277001326	<b>326058</b>	<b>158.60 L</b>
GTX Wake Pro 215	1503	09	277001438 277001555 277001578		
GTX Wake Pro 215	1503	10-14	277001602	<b>329167</b>	<b>104.95 L</b>
			277001699		
GTX Wake S.C. 215 S.C.= Super Charged	1503	07-08	277001326 277001438 277001555 277001578	<b>326058</b>	<b>158.60 L</b>
RXP N/A 155	1503	08	277000843 277001010 277001322 277001474 277001532 277001580	<b>326057</b>	<b>141.90 L</b>
RXP S.C. 215	1503	04-06	277001010 277001474 277001580	<b>326052</b>	<b>138.55 L</b>
RXP S.C. 215	1503	04-09	277000843 277001010 277001322 277001474 277001532 277001580	<b>326057</b>	<b>141.90 L</b>
RXP S.C. 215 OldStyle	1503	05	277001327	<b>326059</b>	<b>141.90 L</b>
RXP S.C. 215 S.C.= Super Charged	1503	09	277001010 277001474 277001580	<b>326052</b>	<b>138.55 L</b>
RXP X 255	1503	08-11	277000843 277001010 277001322 277001474 277001532 277001580	<b>326057</b>	<b>141.90 L</b>
RXP X 255	1503	09-11	277001010 277001474 277001580	<b>326052</b>	<b>138.55 L</b>
RXP X 260	1503	12-14	277001326 277001438 277001555 277001578	<b>326058</b>	<b>158.60 L</b>
RXT is 255	1503	09	277001602	<b>329167</b>	<b>104.95 L</b>
RXT is 260	1503	10-12	277001699		

MODEL	CC	YEAR	OEM #	PART #	
<b>SEA-DOO CONTINUED</b>					
<b>326052 NO ADJUSTABLE NUT</b>			<b>326057 HAS ADJUSTABLE NUT</b>		
RXT S.C. 215	1503	05-09	277001326 277001438 277001555 277001578	<b>326058</b>	<b>158.60 L</b>
RXT S.C. 215	1503	10	277001602	<b>329167</b>	<b>104.95 L</b>
			277001699		
RXT X 255	1503	08-09	277001326 277001438 277001555 277001578	<b>326058</b>	<b>158.60 L</b>
RXT X 260	1503	10-14	277001602 277001699	<b>329167</b>	<b>104.95 L</b>
<b>YAMAHA</b>					
Wave Jammer	500	89-90	EW3-61481-02-00	<b>326068</b>	<b>54.80 L</b>
Wave Runner	500	89	EU0-U1481-00-00	<b>326069</b>	<b>83.45 L</b>
Wave Runner	500	92-93			
LX	650	92-93			
Super Jet	650	90-93	EW2-61481-00-00 EW2-U1481-00-00	<b>326100</b>	<b>116.85 L</b>
VXR	650	91-93	FN8-U1481-00-00	<b>326038</b>	<b>100.00 L</b>
VXR	650	95			
Wave Runner III	650	90-93	FJ0-61481-00-00	<b>326067</b>	<b>83.45 L</b>
Wave Runner III	650	95-96			
Super Jet	700	95	EW2-61481-00-00 EW2-U1481-00-00	<b>326100</b>	<b>116.85 L</b>
Super Jet	700	96-05	GM6-61481-00-00	<b>326103</b>	<b>96.80 L</b>
Super Jet	700	08-15	F2F-61481-00-00	<b>329194</b>	<b>99.95 L</b>
VXR Pro	700	93-94	FN8-U1481-00-00	<b>326038</b>	<b>100.00 L</b>
Wave Blaster	700	93-96	GA7-61481-00-00	<b>326093</b>	<b>99.95 L</b>
Wave Raider	700	95-97	GH6-U1481-00-00	<b>326073</b>	<b>120.65 L</b>
Wave Runner III	700	94-95	FJ0-61481-00-00	<b>326067</b>	<b>83.45 L</b>
Wave Runner III	700	97			
Wave Venture	700	95-96	GJ3-U1481-00-00	<b>326102</b>	<b>116.85 L</b>

- accessories
- towables
- body
- controls**
- electrical
- driveline
- engine
- fuel & intake
- chemicals
- tie downs
- tools
- towing & loading

# MARINE

## WSM STEERING CABLES CONTINUED

- accessories
- towables
- body
- controls**
- electrical
- driveline
- engine
- fuel & intake
- chemicals
- tie downs
- tools
- towing & loading

MARINE

MODEL	CC	YEAR	OEM #	PART #		
<b>YAMAHA CONTINUED</b>						
XL	700	99-04	GU2-U1481-00-00	<b>326105</b>	<b>166.95</b>	L
			GU2-U1481-01-00			
			GU2-U1481-02-00			
			GU2-U1481-10-00			
GP	760	99-00	GP7-U1481-00-00	<b>326074</b>	<b>156.90</b>	L
Wave Raider	760	96	GH6-U1481-00-00	<b>326073</b>	<b>120.65</b>	L
Wave Runner	760	97-98	GP7-U1481-00-00	<b>326074</b>	<b>156.90</b>	L
XL	760	99	GU2-U1481-00-00	<b>326105</b>	<b>166.95</b>	L
			GU2-U1481-01-00			
			GU2-U1481-02-00			
			GU2-U1481-10-00			
GP	800	98-00	GP7-U1481-00-00	<b>326074</b>	<b>156.90</b>	L
GP	800	01-02	F0X-U1481-00-00	<b>326071</b>	<b>171.95</b>	L
GP-R	800	03	F0X-U1481-10-00			
XL	800	00-01	F0D-U1481-00-00	<b>326070</b>	<b>149.95</b>	L
XLT	800	02-04	F0D-U1481-10-00			
FX	1000	05-08	F1S-61481-00-00	<b>329170</b>	<b>187.95</b>	L
FX 140	1000	02-04	F1B-61481-01-00	<b>329005</b>	<b>179.95</b>	H
FX Cruiser	1000	03-04	F1B-61481-02-00			
FX Cruiser	1000	05-08	F1S-61481-00-00	<b>329170</b>	<b>187.95</b>	L
FX Cruiser HO	1100	04	F1B-61481-01-00	<b>329005</b>	<b>179.95</b>	H
			F1B-61481-02-00			
FX Cruiser HO	1100	05-08	F1S-61481-00-00	<b>329170</b>	<b>187.95</b>	L
FX HO	1100	05-08				
V1	1100	15	F2N-61481-00-00	<b>329168</b>	<b>198.95</b>	L
V1 Sport	1100	15				
VX	1100	07-09	F1K-61481-00-00	<b>329169</b>	<b>199.95</b>	L
VX Cruiser	1100	07-09	F1K-61481-01-00			
VX Cruiser	1100	10-15	F2N-61481-00-00	<b>329168</b>	<b>198.95</b>	L
VX Deluxe	1100	05-09	F1K-61481-00-00	<b>329169</b>	<b>199.95</b>	L
			F1K-61481-01-00			
VX Deluxe	1100	10-15	F2N-61481-00-00	<b>329168</b>	<b>198.95</b>	L

MODEL	CC	YEAR	OEM #	PART #		
<b>YAMAHA CONTINUED</b>						
VX Sport	1100	05-09	F1K-61481-00-00	<b>329169</b>	<b>199.95</b>	L
			F1K-61481-01-00			
VX Sport	1100	10-15	F2N-61481-00-00	<b>329168</b>	<b>198.95</b>	L
Wave Raider	1100	95-96	GJ1-U1481-00-00	<b>326094</b>	<b>100.15</b>	L
Wave Venture	1100	96-97	GH3-61480-00-00	<b>326072</b>	<b>149.95</b>	L
			GH3-U1481-00-00			
GP	1200	97-99	GP8-U1481-00	<b>326104</b>	<b>150.25</b>	L
GP-R	1200	00-02	F0X-U1481-00-00	<b>326071</b>	<b>171.95</b>	L
			F0X-U1481-10-00			
XL	1200	98	GU2-U1481-00-00	<b>326105</b>	<b>166.95</b>	L
			GU2-U1481-01-00			
			GU2-U1481-02-00			
			GU2-U1481-10-00			
XL LTD	1200	99-00	F0D-U1481-00-00	<b>326070</b>	<b>149.95</b>	L
XLT	1200	01-05	F0D-U1481-10-00			
GP-R	1300	03-08	F1G-61481-01-00	<b>329004</b>	<b>179.95</b>	E
			F1G-61481-02-00			
FX Cruiser HO	1800	09-10	F1S-61481-00-00	<b>329170</b>	<b>187.95</b>	L
FX Cruiser HO	1800	11-15	F1S-61481-10-00	<b>329173</b>	<b>187.95</b>	J
FX Cruiser SHO	1800	08-10	F1S-61481-00-00	<b>329170</b>	<b>187.95</b>	L
FX Cruiser SHO	1800	11-15	F1S-61481-10-00	<b>329173</b>	<b>187.95</b>	J
FX Cruiser SVHO	1800	14-15				
FX HO	1800	09-10	F1S-61481-00-00	<b>329170</b>	<b>187.95</b>	L
FX HO	1800	11-15	F1S-61481-10-00	<b>329173</b>	<b>187.95</b>	J
FX SHO	1800	08-10	F1S-61481-00-00	<b>329170</b>	<b>187.95</b>	L
FX SHO	1800	11-15	F1S-61481-10-00	<b>329173</b>	<b>187.95</b>	J
FX SVHO	1800	14-15				
FZR	1800	09-10	F2C-61481-00-00	<b>329171</b>	<b>192.95</b>	J
FZR	1800	11-15	F2C-61481-10-00	<b>329172</b>	<b>192.95</b>	J
FZS	1800	09-10	F2C-61481-00-00	<b>329171</b>	<b>192.95</b>	J
FZS	1800	11-15	F2C-61481-10-00	<b>329172</b>	<b>192.95</b>	J
VXR	1800	11-14	F2N-61481-00-00	<b>329168</b>	<b>198.95</b>	L

## WSM TILT CABLES

- High quality replacement tilt cables feature stainless steel fittings and inner vinyl lining
- All cables are manufactured to OEM specifications



MAKE/MODEL	CC	YEAR	OEM #	MFG #	PART #		
<b>YAMAHA</b>							
Wave Raider	700	94-95	GH1-6153D-00-00	002-096	<b>326119</b>	<b>65.15</b>	L
Wave Raider Deluxe	700	95	GH1-6153D-10-00	002-096	<b>326119</b>	<b>65.15</b>	L
GP	760	99-00	GP7-U153D-00-00	002-052-01	<b>326076</b>	<b>43.35</b>	L
Wave Blaster	760	97	GH1-6153D-00-00	002-096	<b>326119</b>	<b>65.15</b>	L
Wave Raider	760	96	GH1-6153D-10-00	002-096	<b>326119</b>	<b>65.15</b>	L
Wave Runner	760	97-98	GP7-U153D-00-00	002-052-01	<b>326076</b>	<b>43.35</b>	L
GP	800	98-00	GP7-U153D-00-00	002-052-01	<b>326076</b>	<b>43.35</b>	L
GP	800	01-02	F0D-U153D-00-00	002-052-02	<b>326077</b>	<b>46.70</b>	L
GP-R	800	03-05	F0D-U153D-01-00	002-052-02	<b>326077</b>	<b>46.70</b>	L
XL	800	00-01	F0D-U153D-10-00	002-052-02	<b>326077</b>	<b>46.70</b>	L
XLT	800	02-03	F0D-U153D-01-00	002-052-02	<b>326077</b>	<b>46.70</b>	L
FX	1000	05-06	F1B-U153D-00-00/ F1B-U153D-01-00	002-052-04	<b>329174</b>	<b>71.95</b>	L
FX	1000	08	F1W-6153E-00-00/ F1W-6153E-01-00	002-052-06	<b>329176</b>	<b>295.95</b>	J
FX 140	1000	02-04	F1B-U153D-00-00	002-052-04	<b>329174</b>	<b>71.95</b>	L
FX Cruiser	1000	03-07	F1B-U153D-01-00	002-052-04	<b>329174</b>	<b>71.95</b>	L
FX Cruiser	1000	08	F1W-6153E-00-00/ F1W-6153E-01-00	002-052-06	<b>329176</b>	<b>295.95</b>	J
FX Cruiser HO	1100	04-07	F1B-U153D-00-00/ F1B-U153D-01-00	002-052-04	<b>329174</b>	<b>71.95</b>	L
FX Cruiser HO	1100	08	F1W-6153E-00-00/ F1W-6153E-01-00	002-052-06	<b>329176</b>	<b>295.95</b>	J
FX HO	1100	04-07	F1B-U153D-00-00/ F1B-U153D-01-00	002-052-04	<b>329174</b>	<b>71.95</b>	L
FX HO	1100	08	F1W-6153E-00-00/ F1W-6153E-01-00	002-052-06	<b>329176</b>	<b>295.95</b>	J
Wave Raider	1100	95-96	GH1-6153D-00-00/ GH1-6153D-10-00	002-096	<b>326119</b>	<b>65.15</b>	L
GP	1200	97-99	GP7-U153D-00-00	002-052-01	<b>326076</b>	<b>43.35</b>	L
GP	1200	00-02	F0D-U153D-00-00	002-052-02	<b>326077</b>	<b>46.70</b>	L
SUV	1200	99-04	F0D-U153D-01-00	002-052-02	<b>326077</b>	<b>46.70</b>	L
XL LTD	1200	99-00	F0D-U153D-10-00	002-052-02	<b>326077</b>	<b>46.70</b>	L
XLT	1200	01-05		002-052-02	<b>326077</b>	<b>46.70</b>	L
GP-R	1300	03-08		002-052-02	<b>326077</b>	<b>46.70</b>	L
FX Cruiser HO	1800	09-11	F1W-6153E-00-00	002-052-06	<b>329176</b>	<b>295.95</b>	J
FX Cruiser SHO	1800	08-11	F1W-6153E-01-00	002-052-06	<b>329176</b>	<b>295.95</b>	J
FX HO	1800	09-11		002-052-06	<b>329176</b>	<b>295.95</b>	J
FX SHO	1800	08-11		002-052-06	<b>329176</b>	<b>295.95</b>	J
FZR	1800	09-15	F2C-6153E-00-00	002-052-05	<b>329175</b>	<b>295.95</b>	J
FZS	1800	09-15	F2C-6153E-00-00	002-052-05	<b>329175</b>	<b>295.95</b>	J

- accessories
- towables
- body
- controls**
- electrical
- driveline
- engine
- fuel & intake
- chemicals
- tie downs
- tools
- towing & loading

MARINE

- accessories
- towables
- body
- controls**
- electrical
- driveline
- engine
- fuel & intake
- chemicals
- tie downs
- tools
- towing & loading

## WSM NOZZLE CABLES

- All stainless steel fittings
- Cables feature inner vinyl linings
- Built to exact OEM specifications



MAKE/MODEL	CC	YEAR	OEM #	MFG #	PART #	
<b>KAWASAKI</b>						
ZXI	750	95	59406-3743	002-041-01	326035	66.75 L
ZXI	900	95-96	59406-3747	002-041-01	326035	66.75 L
<b>SEA-DOO</b>						
SPX	650	95	291000405	002-047-01	326062	121.00 L
XP	650	93-94	291000405	002-047-01	326062	121.00 L
XPI	650	94	291000405	002-047-01	326062	121.00 L
<b>YAMAHA</b>						
GP	760	97-00	GP7-6153E-09-00	002-052-07	329177	141.86 L
GP	800	98-00	GP7-U153E-00-00	002-052-07	329177	141.86 L
GP	800	01-02	F0X-U153E-00-00	002-052-08	329178	165.95 L
GP-R	800	03	F0X-U153E-01-00	002-052-08	329178	165.95 L
GP-R	800	04	F0X-U153E-10-00	002-052-03	329006	164.95 L
XL	800	00-01	F0D-6153E-19-00	002-052-03	329006	164.95 L
XLT	800	02-04	F0D-U153E-00-00	002-052-03	329006	164.95 L
FX	1000	05-07	F0D-U153E-10-00	002-052-10	329180	159.95 J
FX 140	1000	02-04	F1B-6153E-01-00	002-052-10	329180	159.95 J
FX CRUISER	1000	03-07	F1B-6153E-02-00	002-052-10	329180	159.95 J
FX CRUISER	1100	04-07	F1S-6153E-00-00	002-052-10	329180	159.95 J
FX HO	1100	04-07	F0X-U153E-01-00	002-052-10	329180	159.95 J
GP-R	1200	00-02	F0D-6153E-19-00	002-052-10	329180	159.95 J
XL LTD	1200	99-00	F0D-U153E-00-00	002-052-08	329178	165.95 L
XLT	1200	01-05	F0D-U153E-10-00	002-052-03	329006	164.95 L
GP-R	1300	03-08	F1G-6153E-01-00	002-052-09	329179	165.95 L



**ELECTRICAL**

- accessories
- towables
- body
- controls
- electrical
- driveline
- engine
- fuel & intake
- chemicals
- tie downs
- tools
- towing & loading



## YUASA BATTERIES

Not all snowmobiles have an electric start, but if you are lucky enough to own a model that does, you know one thing: you want it to start when you push that button. And so does the manufacturer. That is why they choose Yuasa. Some of Yuasa's most heavy-duty batteries live under the hoods of some of the biggest and fastest snow machines in the country. Just ask Arctic Cat, Bombardier (Ski-Doo), Kawasaki, Polaris and Yamaha. Manufacturers demand the best and they overwhelmingly choose Yuasa. So should you.

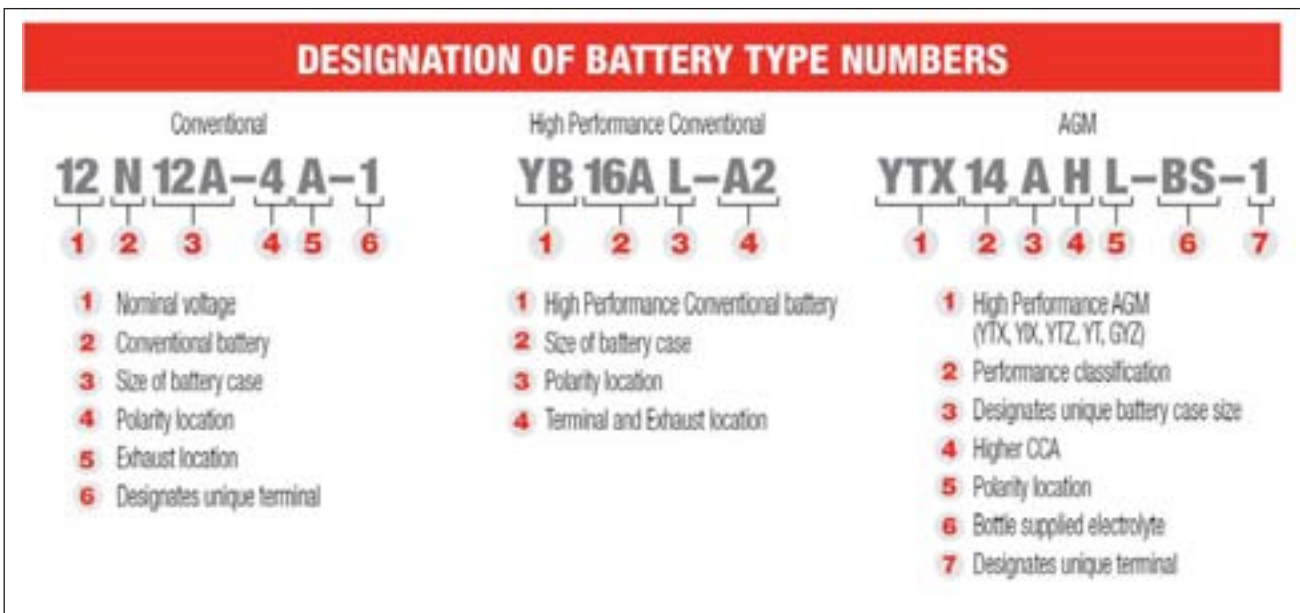

### MAINTENANCE FREE HIGH PERFORMANCE

If high power is top priority in a replacement battery, look to Yuasa's High Performance Maintenance Free batteries. Yuasa means more power, less maintenance and longer life. Yuasa's High Performance Maintenance Free batteries are your best choice for motorcycles, utility vehicles, scooters, ATVs, riding mowers, personal watercraft and snowmobiles.

**ALL OF THE FEATURES OF A STANDARD MAINTENANCE FREE PLUS**  
**Increased Power – Up to 30% more cranking amps** thanks to a radial grid design and additional plates.  
**Selected types also available in Factory Activated** (filled, sealed and charged at the factory).



# MARINE

BATTERY TYPE	YUASA HIGH PERFORMANCE			YUASA FACTORY ACTIVATED H. PERF.		
	920-101	100.95	E	920-134	111.95	E
YTX14H-BS	920-101	100.95	E	920-134	111.95	E
YTX14AH-BS	920-102	104.95	E	920-131	107.95	E
YTX14AHL-BS	920-103	104.95	E	920-132	107.95	E
YTX20H-BS	920-104	122.95	E	920-137	124.95	E
YTX20HL-BS	920-105	122.95	E	920-138	124.95	E
YTX20HL-BS-PW	920-106	124.95	E	920-140	125.95	E
YTX24HL-BS	920-107	139.95	E	920-139	141.95	E
YTX20CH-BS	920-108	122.95	E	----	----	----
YIX30L-BS	920-109	157.95	E	920-145	157.95	E
YIX30-L-BS-PW	258012	156.95	E	----	----	----

~ IMPORTANT ~

Yuasa High Performance Batteries are shipped with 1 acid pack. The battery must be filled and charged prior to first use.

~~~~~

Yuasa High Performance Factory Activated Batteries have been filled with acid and charged at the factory. We recommend you charge these batteries prior to first use.

## YUASA BATTERIES

Not all snowmobiles have an electric start, but if you are lucky enough to own a model that does, you know one thing: you want it to start when you push that button. And so does the manufacturer. That is why they choose Yuasa. Some of Yuasa's most heavy-duty batteries live under the hoods of some of the biggest and fastest snow machines in the country. Just ask Arctic Cat, Bombardier (Ski-Doo), Kawasaki, Polaris and Yamaha. Manufacturers demand the best and they overwhelmingly choose Yuasa. So should you.

- accessories
- towables
- body
- controls
- electrical**
- driveline
- engine
- fuel & intake
- chemicals
- tie downs
- tools
- towing & loading

### YTZ MAINTENANCE FREE

A range of high performance, compact and lightweight batteries designed to provide maximum power from minimum space. Designed to meet the increasing demands of today's high performance machines the Yuasa YTZ range are the only powersports battery in the world to incorporate expanded plate technology. Smaller, lighter and more volume efficient, Yuasa YTZ batteries provide greater starting power from minimum space. Factory sealed and activated they are completely spill proof enabling multi-angle fitment, never require topping off and are maintenance free for the life of the battery.

- Up to 80% more starting power per Kg
- Maximum power – minimum space
- Reduced self discharge for longer life
- Superior vibration resistance



| BATTERY TYPE | YUASA YTZ M/F FACTORY ACTIVATED |        |   |
|--------------|---------------------------------|--------|---|
| YTZ7S        | 920-141                         | 129.95 | E |
| YTZ10S       | 920-142                         | 170.95 | E |
| YTZ12S       | 920-143                         | 184.95 | E |
| YTZ14S       | 920-144                         | 207.95 | E |
| YTZ5S-BS     | 258006                          | 101.95 | E |

**~ IMPORTANT ~**  
 Yuasa YTZ Maintenance Free Batteries have been filled with acid and charged at the factory. We recommend you charge these batteries prior to first use.

### GYZ MAINTENANCE FREE

#### INTRODUCING THE GYZ SERIES – NEXT GENERATION POWERSPORTS BATTERY



- AGM (Absorbed Glass Mat) separators with superior grid and component designs
- Improved charge recovery capability from a deeply discharged condition
- Longer shelf life
- Improved life cycle performance
- Extreme vibration resistance
- Supplied "Factory Activated" (non-spillable)
- Heavy duty, flush mounted terminals. Patent pending embedded brass nut
- Upgrade for customized motorcycles requiring the best performance

**~ IMPORTANT ~**  
 Yuasa YTZ Maintenance Free Batteries have been filled with acid and charged at the factory. We recommend you charge these batteries prior to first use.



| BATTERY TYPE | REPLACES STANDARD BATTERY | ADDITIONAL AMP HOURS | ADDITIONAL CCA | YUASA GYZ FACTORY ACTIVATED |        |   |
|--------------|---------------------------|----------------------|----------------|-----------------------------|--------|---|
| GYZ16HL      | YTX14L                    | 4                    | 40             | 258004                      | 126.95 | E |
| GYZ16H       | YTX14H                    | 4                    | 40             | 258011                      | 126.95 | E |
| GYZ20HL      | YTX20L                    | 2                    | -              | 920-241                     | 141.95 | E |
| GYZ20H       | YTX20H                    | 2                    | -              | 258009                      | 139.95 | E |
| GYZ20L       | YTX20L                    | 2                    | -              | 258010                      | 120.95 | E |
| GYZ32HL      | YIX30L                    | 2                    | 115            | 258005                      | 201.95 | E |

# MARINE

## YUASA BATTERIES

Not all snowmobiles have an electric start, but if you are lucky enough to own a model that does, you know one thing: you want it to start when you push that button. And so does the manufacturer. That is why they choose Yuasa. Some of Yuasa's most heavy-duty batteries live under the hoods of some of the biggest and fastest snow machines in the country. Just ask Arctic Cat, Bombardier (Ski-Doo), Kawasaki, Polaris and Yamaha. Manufacturers demand the best and they overwhelmingly choose Yuasa. So should you.

### MAINTENANCE FREE

Absorbed Glass Mat (AGM) Technology is an advanced battery design used in Yuasa's Maintenance Free Batteries that eliminates water loss. Once it's filled with acid the battery is permanently sealed - so you'll never need to fill it with water or check the acid level.

#### Long Life

Because of its lead calcium design, the AGM battery will hold its specific gravity more than three times longer than conventional lead antimony types. This means much longer periods between charges when the battery is used in a standby mode, like winter storage. And to remain factory-fresh the AGM battery is shipped dry along with its own pack of high-gravity acid that's added at the time of installation.

#### Sealed, Non-spillable

Once filled with acid from its special packs, the AGM battery is virtually maintenance free. It's totally sealed and all of the acid is absorbed in the special plates and separators, so there is no need to worry about acid leaks on valuable vehicle parts and accessories.

**Selected types also available in Factory Activated** (filled, sealed and charged at the factory).

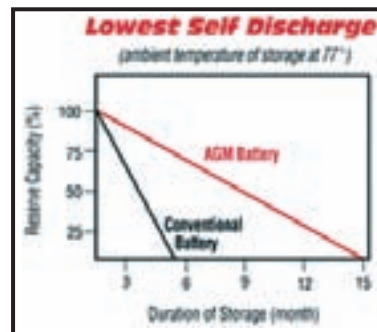

#### ~ IMPORTANT ~

Yuasa Maintenance Free Batteries are shipped with 1 acid pack. The battery must be filled and charged prior to first use.

Yuasa Maintenance Free Factory Activated Batteries have been filled with acid and charged at the factory. We recommend you charge these batteries prior to first use.

| BATTERY TYPE | YUASA MAINTENANCE FREE |        |      | YUASA FACTORY ACTIVATED M/F |        |      |
|--------------|------------------------|--------|------|-----------------------------|--------|------|
|              | Part No.               | Price  | Code | Part No.                    | Price  | Code |
| YTX4L-BS     | 920-110                | 44.95  | E    | ----                        |        |      |
| YTX5L-BS     | 920-111                | 51.95  | E    | ----                        |        |      |
| YT7B-BS      | 920-112                | 90.95  | E    | ----                        |        |      |
| YTX7A-BS     | 920-113                | 69.95  | E    | ----                        |        |      |
| YTX7L-BS     | 920-114                | 67.95  | E    | ----                        |        |      |
| YTX9-BS      | 920-115                | 77.95  | E    | 920-128                     | 88.95  | E    |
| YT9B-BS      | 920-116                | 103.95 | E    | ----                        |        |      |
| YT12A-BS     | 920-117                | 105.95 | E    | ----                        |        |      |
| YT12B-BS     | 920-118                | 107.95 | E    | 920-129                     | 94.95  | E    |
| YTX12-BS     | 920-119                | 87.95  | E    | ----                        |        |      |
| YTX14-BS     | 920-120                | 93.95  | E    | 920-130                     | 100.95 | E    |
| YTX14L-BS    | 920-121                | 93.95  | E    | 920-133                     | 107.95 | E    |
| YT14B-BS     | 920-122                | 134.95 | E    | ----                        |        |      |
| YTX15L-BS    | 920-123                | 117.95 | E    | ----                        |        |      |
| YTX16-BS     | 920-124                | 110.95 | E    | ----                        |        |      |
| YTX16-BS-1   | 920-125                | 110.95 | E    | ----                        |        |      |
| YTX20-BS     | 920-126                | 113.95 | E    | 920-135                     | 115.95 | E    |
| YTX20L-BS    | 920-127                | 113.95 | E    | 920-136                     | 115.95 | E    |
| YT19BL-BS    | 258007                 | 123.95 | E    | ----                        |        |      |

- accessories
- towables
- body
- controls
- electrical
- driveline
- engine
- fuel & intake
- chemicals
- tie downs
- tools
- towing & loading

MARINE



## YUASA BATTERIES

Not all snowmobiles have an electric start, but if you are lucky enough to own a model that does, you know one thing: you want it to start when you push that button. And so does the manufacturer. That is why they choose Yuasa. Some of Yuasa's most heavy-duty batteries live under the hoods of some of the biggest and fastest snow machines in the country. Just ask Arctic Cat, Bombardier (Ski-Doo), Kawasaki, Polaris and Yamaha. Manufacturers demand the best and they overwhelmingly choose Yuasa. So should you.

## YUMICRON

The Yuasa YuMicron gives you a powerful advantage. Its high technology separators allow two extra plates per cell to be installed, for a 30% improvement in cranking performance

**The Power Advantage**

This added power is an outstanding benefit for heavily accessorized machines or high compression engines. Its high cranking power is also a real bonus for easier starting.



| BATTERY TYPE | YUASA YUMICRON |       |   |
|--------------|----------------|-------|---|
| YB2.5L-C     | 920-149        | 31.95 | E |
| YB2.5L-C-1   | 920-150        | 31.95 | E |
| YB3L-A       | 920-151        | 35.95 | E |
| YB3L-B       | 920-152        | 40.95 | E |
| YB4L-A       | 920-153        | 40.95 | E |
| YB4L-B       | 920-154        | 27.95 | E |
| YB5L-B       | 920-155        | 33.95 | E |
| YB7-A        | 920-156        | 40.95 | E |
| YB7B-B       | 920-157        | 47.95 | E |
| YB7C-A       | 920-158        | 49.95 | E |
| YB7L-B       | 920-159        | 55.95 | E |
| YB9A-A       | 920-160        | 54.95 | E |
| YB9L-A2      | 920-161        | 67.95 | E |
| YB9-B        | 920-162        | 49.95 | E |
| YB9L-B       | 920-163        | 49.95 | E |
| YB10A-A2     | 920-164        | 56.95 | E |
| YB10L-A2     | 920-165        | 56.95 | E |
| YB10L-B      | 920-166        | 62.95 | E |
| YB10L-B2     | 920-167        | 62.95 | E |
| YB12A-A      | 920-168        | 55.95 | E |

| BATTERY TYPE          | YUASA YUMICRON |        |   |
|-----------------------|----------------|--------|---|
| YB12AL-A              | 920-171        | 59.95  | E |
| YB12AL-A2             | 920-172        | 59.95  | E |
| YB12A-B               | 920-173        | 71.95  | E |
| YB12B-B2              | 920-174        | 77.95  | E |
| YB12C-A               | 920-175        | 60.95  | E |
| YB14-A2               | 920-176        | 62.95  | E |
| YB14A-A1              | 920-177        | 66.95  | E |
| YB14A-A2              | 920-178        | 62.95  | E |
| YB14L-A1              | 920-179        | 70.95  | E |
| YB14L-A2              | 920-180        | 62.95  | E |
| YB14L-A2 W/<br>SENSOR | 920-181        | 68.95  | E |
| YB14L-B2              | 920-182        | 71.95  | E |
| YB14-B2               | 920-183        | 71.95  | E |
| SYB14L-A2             | 920-184        | 106.95 | E |
| YB16AL-A2             | 920-185        | 83.95  | E |
| HYB16A-AB             | 920-186        | 99.95  | E |
| YB16-B                | 920-187        | 76.95  | E |
| YB16L-B               | 920-188        | 81.95  | E |
| YB16B-A               | 920-189        | 119.95 | E |
| YB16B-A1              | 920-190        | 118.95 | E |
| YB16C-B               | 920-191        | 96.95  | E |
| YB16CL-B              | 920-192        | 75.95  | E |
| YB18-A                | 920-193        | 84.95  | E |
| YB18L-A               | 920-194        | 84.95  | E |
| Y50-N18A-A            | 920-195        | 121.95 | E |
| Y50-N18L-A            | 920-196        | 78.95  | E |
| Y50-N18L-A3           | 920-197        | 78.95  | E |
| SY50-N18L-AT          | 920-198        | 92.95  | E |
| YB30L-B               | 920-203        | 114.95 | E |
| YB30CL-B              | 920-204        | 128.95 | E |
| 51814                 | 920-205        | 109.95 | E |
| 51913                 | 920-206        | 97.95  | E |
| 53030                 | 920-207        | 126.95 | E |

## BATTERY ACID



- Battery acid used in Yumicron and Conventional type batteries
- Not to be used in Maintenance free type batteries
- 21 oz. (620 ml)

SO-ACID 4.95 ea G

accessories

towables

body

controls

electrical

driveline

engine

fuel &amp; intake

chemicals

tie downs

tools

towing &amp; loading

MARINE

## YUASA BATTERIES

Not all snowmobiles have an electric start, but if you are lucky enough to own a model that does, you know one thing: you want it to start when you push that button. And so does the manufacturer. That is why they choose Yuasa. Some of Yuasa's most heavy-duty batteries live under the hoods of some of the biggest and fastest snow machines in the country. Just ask Arctic Cat, Bombardier (Ski-Doo), Kawasaki, Polaris and Yamaha. Manufacturers demand the best and they overwhelmingly choose Yuasa. So should you.

### YUMICRON CX

*The YuMicron CX was the first small engine starting battery to use "lead calcium" technology. This special technology means the YuMicron CX generates more power, requires less maintenance, and lasts longer than any other conventional battery.*

#### More Power

Because of its unique design, the CX will generate 5% to 8% more cold cranking amperage than our own high-output YuMicron lead-antimony battery. For high compression machines, this means greater reserve capacity and more starting power.

#### Less Maintenance

The YuMicron CX lead calcium technology also reduces water loss, so the CX requires servicing (water filling) only about one-eighth as often as ordinary lead-antimony types.

#### Longer Life

The YuMicron CX holds its specific gravity more than three times as long as lead-antimony type batteries resulting in a longer shelf life. This feature means longer periods between charges, especially during winter months.

| BATTERY TYPE   | YUASA YUMICRON CX |        |   |
|----------------|-------------------|--------|---|
| YB16-B-CX      | 920-146           | 97.95  | E |
| YB16HL-A-CX    | 920-147           | 96.95  | E |
| Y50-N18L-A3-CX | 920-148           | 100.95 | E |

#### ~ IMPORTANT ~

Yuasa Yumicron/Yumicron CX Batteries are shipped dry with no acid. To order acid for your battery first check the acid volume needed on the Battery Specification Chart then order part # **SO-ACID** for every 21 oz. needed.



### CONVENTIONAL

A workhorse battery engineered to protect against corrosion, withstand vibration and deliver high cranking power.

The industry standard for motorcycles and riding mowers, our Conventional Battery is anything but conventional. This workhorse is for applications requiring operation on uneven surfaces and vibrating environments - even when the weather's dealing its worst. It's the rugged, reliable and dependable battery that customers are looking for!

These features are built into our conventional manifold vented battery - and every battery in the YUASA line:

- Patented separators provide high cranking power
- Through-partition construction delivers maximum power
- Unique sealed posts resist corrosion for longer battery life
- Polypropylene cover and container thwart damage from gas, oil, and impact
- Heat-sealed, bonded unit fabrication protects against seepage and corrosion

#### ~ IMPORTANT ~

Yuasa Conventional Batteries are shipped dry with no acid. To order acid for your battery first check the acid volume needed on the Battery Specification Chart then order part # **SO-ACID** for every 21 oz. needed.



| BATTERY TYPE | YUASA CONVENTIONAL |        |   |
|--------------|--------------------|--------|---|
| 12N5-3B      | 920-208            | 36.95  | E |
| 12N5-4B      | 920-209            | 36.95  | E |
| 12N5.5-3B    | 920-210            | 46.95  | E |
| 12N5.5-4A    | 920-211            | 50.95  | E |
| 12N5.5A-3B   | 920-212            | 39.95  | E |
| 12N7-3B      | 920-213            | 42.95  | E |
| 12N7-4A      | 920-214            | 40.95  | E |
| 12N7-4B      | 920-215            | 51.95  | E |
| 12N7D-3B     | 920-216            | 40.95  | E |
| 12N9-3A      | 920-217            | 53.95  | E |
| 12N9-3B      | 920-218            | 51.95  | E |
| 12N9-4B-1    | 920-219            | 38.95  | E |
| 12N12A-4A-1  | 920-222            | 46.95  | E |
| 12N14-3A     | 920-223            | 46.95  | E |
| 12N24-3A     | 920-224            | 97.95  | E |
| 12N24-3      | 920-225            | 104.95 | E |
| YHD-12H      | 920-226            | 117.95 | E |

# POWER SONIC

## POWER SONIC BATTERIES

Tough. Reliable. Whether you ride daily, seasonally, or just on weekends, you'll get more enjoyment out of your motorcycle, ATV, PWC or snowmobile with a Power Sonic battery. Our batteries perform reliably during off-road, over water and cold weather use, and keep their charge even after months of storage. Available in traditional flooded or the new sealed AGH designs, Power Sonic batteries are built to withstand punishing vibration, salt spray, gas and oil, and protect against equipment-damaging spills, corrosion and seepage. And because nothing ruins a weekend faster than a dead battery, we use advanced designs and manufacturing techniques to shorten current paths and reduce resistance, giving you higher cranking power and maximum battery life.

### MAINTENANCE FREE HIGH PERFORMANCE

#### SEALED MAINTENANCE FREE

Once these batteries are put into service, they become a completely sealed unit requiring a lot less maintenance than Conventional Batteries. Although the battery still needs to be charged on a regular basis if your vehicle is not in use, there is no need to monitor the fluid level in this battery type. Unlike the Conventional Battery, once this type battery is sealed, it becomes spill proof, which can eliminate damage from battery acid that can occur from using a flooded battery.

#### FACTORY ACTIVATED MAINTENANCE FREE

The same convenience and technology as the Sealed Maintenance Free Batteries mentioned above, except this battery is sealed and activated at the time of manufacture. Very convenient to the point that all that needs to be done is put the battery into your vehicle and you are ready to ride. The only downside of this type of battery is that all batteries once activated have a shelf life, and if this battery is not going to be used right away, or be put in a vehicle that is not going to ridden on a regular basis, the battery will need to be kept charged on a battery maintainer.



| BATTERY TYPE | POWER SONIC HIGH PERFORMANCE |        |      | POWER SONIC FACTORY ACTIVATED H PERF. |        |      |
|--------------|------------------------------|--------|------|---------------------------------------|--------|------|
|              | Part No.                     | Price  | Code | Part No.                              | Price  | Code |
| PTX14AH-BS   | SO3349                       | 62.95  | G    | 360019                                | 66.95  | G    |
| PTX14AHL-BS  | SO3351                       | 62.95  | G    | 360020                                | 66.95  | G    |
| PTX20HL-BS   | ----                         |        |      | 360001                                | 99.95  | G    |
| PTX24HL-BS   | SO3324**                     | 119.95 | G    | ----                                  |        |      |
| PTX20CH-BS   | SO3354                       | 76.95  | G    | ----                                  |        |      |
| PIX30HL-BS   | ----                         |        |      | 360002                                | 130.95 | G    |

\*\* (PTX50L-BS)

**~ IMPORTANT ~**  
 Power Sonic High Performance Batteries are shipped with 1 acid pack. The battery must be filled and charged prior to first use.  
 ~~~~  
 Power Sonic High Performance Factory Activated Batteries have been filled with acid and charged at the factory. We recommend you charge these batteries prior to first use.

### PTZ MAINTENANCE FREE

Factory sealed and activated PTZ Batteries are smaller and lighter and designed to provide maximum power in minimum space.

| BATTERY TYPE | Part No. | Price | Code |
|--------------|----------|-------|------|
| PTZ5S        | 360005   | 41.95 | G    |
| PTZ7S        | 360010   | 47.95 | G    |
| PTZ10S       | 360013   | 73.95 | G    |
| PTZ12S       | 360016   | 81.95 | G    |
| PTZ14S       | 360022   | 92.95 | G    |



- accessories
- towables
- body
- controls
- electrical
- driveline
- engine
- fuel & intake
- chemicals
- tie downs
- tools
- towing & loading

MARINE



## POWER SONIC BATTERIES

Tough. Reliable. Whether you ride daily, seasonally, or just on weekends, you'll get more enjoyment out of your motorcycle, ATV, PWC or snowmobile with a Power Sonic battery. Our batteries perform reliably during off-road, over water and cold weather use, and keep their charge even after months of storage. Available in traditional flooded or the new sealed AGH designs, Power Sonic batteries are built to withstand punishing vibration, salt spray, gas and oil, and protect against equipment-damaging spills, corrosion and seepage. And because nothing ruins a weekend faster than a dead battery, we use advanced designs and manufacturing techniques to shorten current paths and reduce resistance, giving you higher cranking power and maximum battery life.

**MAINTENANCE FREE**

### SEALED MAINTENANCE FREE

Once these batteries are put into service, they become a completely sealed unit requiring a lot less maintenance than Conventional Batteries. Although the battery still needs to be charged on a regular basis if your vehicle is not in use, there is no need to monitor the fluid level in this battery type. Unlike the Conventional Battery, once this type battery is sealed, it becomes spill proof, which can eliminate damage from battery acid that can occur from using a flooded battery.

### FACTORY ACTIVATED MAINTENANCE FREE

The same convenience and technology as the Sealed Maintenance Free Batteries mentioned above, except this battery is sealed and activated at the time of manufacture. Very convenient to the point that all that needs to be done is put the battery into your vehicle and you are ready to ride. The only downside of this type of battery is that all batteries once activated have a shelf life, and if this battery is not going to be used right away, or be put in a vehicle that is not going to ridden on a regular basis, the battery will need to be kept charged on a battery maintainer.



| BATTERY TYPE | POWER SONIC MAINTENANCE FREE |          | POWER SONIC FACTORY ACTIVATED M/F |          |
|--------------|------------------------------|----------|-----------------------------------|----------|
| PTX4L-BS     | SO3340                       | 28.95 G  | 360003                            | 30.95 G  |
| PTX5L-BS     | SO3335                       | 33.95 G  | 360004                            | 37.95 G  |
| PTX7A-BS     | 360037                       | 36.95 G  | 360008                            | 39.95 G  |
| PTX7L-BS     | SO3292                       | 46.95 G  | 360009                            | 49.95 G  |
| PTX9-BS      | SO3339                       | 46.95 G  | 360012                            | 49.95 G  |
| PT12A-BS     | 360040                       | 73.95 G  | ----                              | ----     |
| PTX12-BS     | SO3342                       | 57.95 G  | 360015                            | 57.95 G  |
| PTX14-BS     | SO3344                       | 63.95 G  | 360018                            | 67.95 G  |
| PTX14L-BS    | 360043                       | 63.95 G  | 360021                            | 67.95 G  |
| PTX15L-BS    | SO3350                       | 66.95 G  | ----                              | ----     |
| PTX16-BS     | SO3346                       | 65.95 G  | ----                              | ----     |
| PTX16-BS-1   | 360044                       | 74.95 G  | ----                              | ----     |
| PTX18L-BS    | SO3347                       | 87.95 G  | ----                              | ----     |
| PTX19CL-BS   | SO3352                       | 113.95 G | 360026                            | 113.95 G |
| PTX20-BS     | ----                         | ----     | 360027                            | 109.95 G |
| PTX20L-BS    | SO3348                       | 90.95 G  | 360028                            | 95.95 G  |
| PIX30L-BS    | SO3353                       | 126.95 G | 360030                            | 126.95 G |



**~ IMPORTANT ~**

Power Sonic Maintenance Free Batteries are shipped with 1 acid pack. The battery must be filled and charged prior to first use.

Power Sonic Maintenance Free Factory Activated Batteries have been filled with acid and charged at the factory. We recommend you charge these batteries prior to first use.

# POWER SONIC

## POWER SONIC BATTERIES

Tough. Reliable. Whether you ride daily, seasonally, or just on weekends, you'll get more enjoyment out of your motorcycle, ATV, PWC or snowmobile with a Power Sonic battery. Our batteries perform reliably during off-road, over water and cold weather use, and keep their charge even after months of storage. Available in traditional flooded or the new sealed AGH designs, Power Sonic batteries are built to withstand punishing vibration, salt spray, gas and oil, and protect against equipment-damaging spills, corrosion and seepage. And because nothing ruins a weekend faster than a dead battery, we use advanced designs and manufacturing techniques to shorten current paths and reduce resistance, giving you higher cranking power and maximum battery life.

### CONVENTIONAL

This type of batteries has flooded electrolyte and is very accessible. These batteries have to be carefully and periodically maintained. The conventional batteries are normally less expensive than the other types mentioned, but with the cost savings come more maintenance. You will need to add distilled water from time to time to prevent the battery from sulfating. Water loss is a normal characteristic of this type of battery because of the high temperature inside, and the process of electrolysis and evaporation. This means the fluid level of the battery needs to be checked on a regular basis. Conventional batteries also tend to discharge more rapidly than AGM type batteries.



| BATTERY TYPE | POWER SONIC CONVENTIONAL |         |
|--------------|--------------------------|---------|
| 12N12A-4A-1  | SO1112                   | 35.95 G |
| 12N14-3A     | SO1114                   | 37.95 G |
| 12N5.5-3B    | 360089                   | 25.95 G |
| 12N5.5-4A    | 360090                   | 26.95 G |
| 12N5.5A-3B   | 360091                   | 28.95 G |
| 12N5-3B      | 360087                   | 24.95 G |
| 12N5-4B      | 360088                   | 24.95 G |
| 12N7-3B      | 360092                   | 36.95 G |
| 12N7-4A      | SO2274                   | 36.95 G |
| 12N7-4B      | 360093                   | 31.95 G |
| 12N7D-3B     | SO3228                   | 30.95 G |
| 12N9-3A-1    | 360094                   | 33.95 G |
| 12N9-3B      | 360095                   | 32.95 G |
| 12N9-4B-1    | SO1109                   | 28.95 G |



### ~ IMPORTANT ~

Power Sonic Conventional Batteries are shipped with 1 acid pack.  
The battery must be filled and charged prior to first use.

Item # SO3290 does not ship with acid. Order part # SO-ACID  
for every 21 oz. needed.

| BATTERY TYPE | POWER SONIC HIGH PERFORM. FLOODED |          |
|--------------|-----------------------------------|----------|
| CB10A-A2     | SO3220                            | 43.95 G  |
| CB10L-A2     | SO2005                            | 41.95 G  |
| CB10L-B      | SO2010                            | 47.95 G  |
| CB10L-B2     | 360064                            | 41.95 G  |
| CB12A-A      | SO2012                            | 42.95 G  |
| CB12A-B      | 360067                            | 50.95 G  |
| CB12AL-A     | 360065                            | 42.95 G  |
| CB12AL-A2    | 360066                            | 43.95 G  |
| CB12B-B2     | 360068                            | 55.95 G  |
| CB12C-A      | SO3224                            | 43.95 G  |
| CB14-A2      | SO2214                            | 49.95 G  |
| CB14A-A      | SO3229                            | 46.95 G  |
| CB14A-A2     | SO3234                            | 46.95 G  |
| CB14-B2      | 360069                            | 56.95 G  |
| CB14L-A1     | 360070                            | 60.95 G  |
| CB14L-A2     | SO2014                            | 46.95 G  |
| CB14L-B2     | 360071                            | 54.95 G  |
| CB16AL-A2    | SO3236                            | 66.95 G  |
| CB16-B       | 360074                            | 67.95 G  |
| CB16B-A      | 360075                            | 84.95 G  |
| CB16B-A1     | 360076                            | 78.95 G  |
| CB16CL-B     | SO3240                            | 62.95 G  |
| CB16L-B      | SO2016                            | 67.95 G  |
| CB18-A       | SO3281                            | 72.95 G  |
| CB18L-A      | 360078                            | 71.95 G  |
| CB2.5L-C     | 360052                            | 18.95 G  |
| CB2.5L-C-1   | 360053                            | 18.95 G  |
| CB30CL-B     | SO3337                            | 98.95 G  |
| CB30L-B      | SO3290                            | 95.95 G  |
| CB3L-A       | 360054                            | 21.95 G  |
| CB3L-B       | 360055                            | 21.95 G  |
| CB4L-A       | 360056                            | 23.95 G  |
| CB4L-B       | 360057                            | 23.95 G  |
| CB5L-B       | 360058                            | 25.95 G  |
| CB7-A        | 360059                            | 35.95 G  |
| CB7C-A       | 360060                            | 41.95 G  |
| CB7L-B       | 360061                            | 41.95 G  |
| CB9A-A       | SO3210                            | 43.95 G  |
| CB9-B        | 360062                            | 39.95 G  |
| CB9L-A2      | SO3214                            | 39.95 G  |
| CB9L-B       | 360063                            | 35.95 G  |
| 51814        | 360084                            | 84.95 G  |
| 53030        | 360086                            | 109.95 G |
| C50-N18A-A   | 360079                            | 84.95 G  |
| C50N18L-A3   | SO2050                            | 67.95 G  |
| SC50-N18L-AT | 360081                            | 94.95 G  |
| SCB14L-A2    | 360072                            | 67.95 G  |

accessories

towables

body

controls

electrical

driveline

engine

fuel &amp; intake

chemicals

tie downs

tools

towing &amp; loading

MARINE



## 12V LITHIUM ION (LiFeP04)

- 80% Lighter than Flooded or AGM lead-acid batteries
- 5 times the battery life
- 2 year shelf life
- 2000+ cycles
- Smaller than comparable lead-acid batteries
- Can be mounted in any direction
- Quad Terminal Configuration
- Operating Temp: 14°F - 140°F
- Max charge rate: 10A
- 3 year Limited Warranty

**SuperSmart™ Lithium Technology**



| BATTERY TENDER LITHIUM BATTERY 120C | BATTERY TENDER LITHIUM BATTERY 240C | BATTERY TENDER LITHIUM BATTERY 300C | BATTERY TENDER LITHIUM BATTERY 360C | BATTERY TENDER LITHIUM BATTERY 480C |
|-------------------------------------|-------------------------------------|-------------------------------------|-------------------------------------|-------------------------------------|
| 462001 99.95 B                      | 462002 149.95 B                     | 462003 199.95 B                     | 462004 229.95 B                     | 462005 299.95 B                     |
| LEAD ACID REPLACEMENT RANGE         |                                     |                                     |                                     |                                     |
| 7-9Ah                               | 10-14Ah                             | 16-18Ah                             | 21-24Ah                             | 26-35Ah                             |
| COLD CRANKING AMPS                  |                                     |                                     |                                     |                                     |
| 120A                                | 240A                                | 300A                                | 360A                                | 480A                                |
| DIMENSIONS                          |                                     |                                     |                                     |                                     |
| 4.21"L x 2.2" W x 3.35"H            | 5.27" L x 2.55"W x 3.62"H           | 6.49"L x 3.38"W x 5.11"H            | 6.49"L x 3.38"W x 5.11"H            | 6.49"L x 3.38"W x 5.11"H            |
| WEIGHT                              |                                     |                                     |                                     |                                     |
| 1.2 lbs                             | 1.76 lbs                            | 2.1 lbs                             | 2.6 lbs                             | 3.75 lbs                            |

### Battery Tender Lithium Battery FAQs:

**What is the difference between Lithium Ion batteries and Lithium Ion Phosphate batteries?**

Lithium-ion batteries are rechargeable batteries that use lithium as one of their active components. Lithium Ion Phosphate Batteries are a type of lithium-ion batteries known for their long life and inherent safety.

**How does the "Lead Acid Equivalent" capacity rating compare to Flooded, AGM, and Gel cell battery ratings?**

The capacity of lead acid batteries decreases markedly when discharged at high currents such as when starting a vehicle. This effect is much less for a lithium battery. In fact, when discharged at a current equal to its capacity, a 2 A-hour lithium ion phosphate battery will have as much capacity as a 9 A-hour lead acid battery.

**Can I use a standard Lead Acid charger/maintainer for my Battery Tender® lithium battery?**

As long as the battery charger does not have a desulfation mode and the peak voltage does not exceed 14.8V during the charge cycle it can be used to charge a Battery Tender® Lithium Battery. Of course the best way to charge and maintain a Battery Tender® Lithium Battery is to use a Battery Tender® Lithium Battery Charger.

**What is the best way to store my battery long term?**

A Battery Tender® Lithium Battery has virtually no self-discharge and has a shelf life of 2 years. The best way to store the battery is disconnected from the vehicle in a clean and dry location with the protective covers installed on the positive terminals.

**How do I prevent water damage or corrosion to my battery?**

A Battery Tender® Lithium Battery has a waterproof construction however the battery should be kept clean to minimize corrosion. A corrosion inhibitor can also be used on the terminal and connections.

**How do Lithium batteries Cold Cranking Amps "CCA" rating compare to Lead Acid batteries?**

When talking about lithium batteries used for engine starting the term CCA is used when making comparisons of the cranking ability to that of a lead acid battery in the same application. It is important to select a Battery Tender® Lithium Battery that has a CCA rating that is equal or greater than the lead acid battery it is replacing.

**What happens if I hook up my battery charger to the wrong terminals?**

If you happen to hook up your battery charger cables in reverse (positive cable to negative terminal and negative cable to positive terminal) then you will potentially damage the battery.

**What happens if I hook up my battery to the wrong terminals on my vehicle?**

If you incorrectly connect your battery to the wrong cables (positive cable to negative terminal and negative cable to positive terminal) then there is a chance for spark and damage to the battery

- accessories
- towables
- body
- controls
- electrical
- driveline
- engine
- fuel & intake
- chemicals
- tie downs
- tools
- towing & loading

## MAINTENANCE FREE HIGH PERFORMANCE BATTERIES

| BATTERY TYPE      | YUASA HIGH PERFORMANCE M/F |          | YUASA FACTORY ACTIVATED HIGH PERFORMANCE M/F |          | POWER SONIC HIGH PERFORMANCE M/F |          | POWER SONIC FACTORY ACTIVATED HIGH PERFORMANCE M/F |          | DELTRAN LITHIUM |          |
|-------------------|----------------------------|----------|--|----------|----------------------------------|----------|--|----------|-----------------|----------|
| YTX14H-BS         | 920-101                    | 100.95 E | 920-134                                      | 111.95 E | -----                            | -----    | -----  | -----    | -----           | -----    |
| YTX14AH-BS        | 920-102                    | 104.95 E | 920-131                                      | 107.95 E | SO3349                           | 62.95 G  | 360019   | 66.95 G  | 462002          | 149.95 B |
| YTX14AHL-BS       | 920-103                    | 104.95 E | 920-132                                      | 107.95 E | SO3351                           | 62.95 G  | 360020   | 66.95 G  | 462002          | 149.95 B |
| YTX20H-BS         | 920-104                    | 122.95 E | 920-137                                      | 124.95 E | -----                            | -----    | -----  | -----    | 462004          | 229.95 B |
| YTX20HL-BS        | 920-105                    | 122.95 E | 920-138                                      | 124.95 E | -----                            | -----    | 360001   | 99.95 G  | -----           | -----    |
| YTX20HL-BS-PW     | 920-106                    | 124.95 E | 920-140                                      | 125.95 E | -----                            | -----    | -----  | -----    | 462004          | 229.95 B |
| YTX24HL-BS        | 920-107                    | 139.95 E | 920-139                                      | 141.95 E | SO3324                           | 119.95 G | -----  | -----    | 462004          | 229.95 B |
| YTX20CH-BS        | 920-108                    | 122.95 E | -----  | -----    | SO3354                           | 76.95 G  | -----  | -----    | -----           | -----    |
| YIX30HL-BS        | -----                      | -----    | -----  | -----    | -----                            | -----    | 360002   | 130.95 G | -----           | -----    |
| ------(PIX50L-BS) | -----                      | -----    | -----  | -----    | -----                            | -----    | -----  | -----    | -----           | -----    |

## MAINTENANCE FREE BATTERIES

| BATTERY TYPE               | YUASA M/F |          | YUASA FACTORY ACTIVATED M/F |          | POWER SONIC M/F |          | POWER SONIC FACTORY ACTIVATED M/F |          | DELTRAN LITHIUM |          |
|----------------------------|-----------|----------|-----------------------------|----------|-----------------|----------|-----------------------------------|----------|-----------------|----------|
| YTX4L-BS                   | 920-110   | 44.95 E  | -----                       | -----    | SO3340          | 28.95 G  | 360003                            | 30.95 G  | 462001          | 99.95 B  |
| YTX5L-BS                   | 920-111   | 51.95 E  | -----                       | -----    | SO3335          | 33.95 G  | 360004                            | 37.95 G  | 462001          | 99.95 B  |
| YT7B-BS                    | 920-112   | 90.95 E  | -----                       | -----    | -----           | -----    | -----                             | -----    | 462001          | 99.95 B  |
| YTX7A-BS                   | 920-113   | 69.95 E  | -----                       | -----    | 360037          | 36.95 G  | 360008                            | 39.95 G  | 462001          | 99.95 B  |
| YTX7L-BS                   | 920-114   | 67.95 E  | -----                       | -----    | SO3292          | 46.95 G  | 360009                            | 49.95 G  | 462001          | 99.95 B  |
| YTX9-BS                    | 920-115   | 77.95 E  | 920-128                     | 88.95 E  | SO3339          | 46.95 G  | 360012                            | 49.95 G  | 462001          | 99.95 B  |
| YT9B-BS                    | 920-116   | 103.95 E | -----                       | -----    | -----           | -----    | -----                             | -----    | 462001          | 99.95 B  |
| YT12A-BS                   | 920-117   | 105.95 E | -----                       | -----    | 360040          | 73.95 G  | -----                             | -----    | 462002          | 149.95 B |
| YT12B-BS                   | 920-118   | 107.95 E | -----                       | -----    | -----           | -----    | -----                             | -----    | 462002          | 149.95 B |
| YTX12-BS                   | 920-119   | 87.95 E  | 920-129                     | 94.95 E  | SO3342          | 57.95 G  | 360015                            | 57.95 G  | 462002          | 149.95 B |
| YTX14-BS                   | 920-120   | 93.95 E  | 920-130                     | 100.95 E | SO3344          | 63.95 G  | 360018                            | 67.95 G  | 462002          | 149.95 B |
| YTX14L-BS                  | 920-121   | 93.95 E  | 920-133                     | 107.95 E | 360043          | 63.95 G  | 360021                            | 67.95 G  | 462002          | 149.95 B |
| YT14B-BS                   | 920-122   | 134.95 E | -----                       | -----    | -----           | -----    | -----                             | -----    | 462002          | 149.95 B |
| YTX15L-BS                  | 920-123   | 117.95 E | -----                       | -----    | SO3350          | 66.95 G  | -----                             | -----    | 462002          | 149.95 B |
| YTX16-BS                   | 920-124   | 110.95 E | -----                       | -----    | SO3346          | 65.95 G  | -----                             | -----    | 462002          | 149.95 B |
| YTX16-BS-1                 | 920-125   | 110.95 E | -----                       | -----    | 360044          | 74.95 G  | -----                             | -----    | 462002          | 149.95 B |
| PTX18L-BS (P. SONIC ONLY)  | -----     | -----    | -----                       | -----    | SO3347          | 87.95 G  | -----                             | -----    | -----           | -----    |
| PTX19CL-BS (P. SONIC ONLY) | -----     | -----    | -----                       | -----    | SO3352          | 113.95 G | 360026                            | 113.95 G | -----           | -----    |
| YTX20-BS                   | 920-126   | 113.95 E | 920-135                     | 115.95 E | -----           | -----    | -----                             | -----    | 462003          | 199.95 B |
| YTX20L-BS                  | 920-127   | 113.95 E | 920-136                     | 115.95 E | SO3348          | 90.95 G  | 360028                            | 95.95 G  | 462003          | 199.95 B |
| YIX30L-BS                  | 920-109   | 157.95 E | 920-145                     | 157.95 E | SO3353          | 126.95 G | 360030                            | 126.95 G | 462005          | 299.95 B |

## YUASA YTZ MAINTENANCE FREE, FACTORY ACTIVATED (12 VOLT) BATTERIES

| BATTERY TYPE | YUASA YTZ M/F FACTORY ACTIVATED |          | POWER SONIC PTZ M/F FACTORY ACTIVATED |         | DELTRAN LITHIUM |          |
|--------------|---------------------------------|----------|---------------------------------------|---------|-----------------|----------|
| GYZ20HL      | 920-241                         | 141.95 E | -----                                 | -----   | -----           | -----    |
| YTZ5S        | -----                           | -----    | 360005                                | 41.95 G | 462001          | 99.95 B  |
| YTZ7S        | 920-141                         | 129.95 E | 360010                                | 47.95 G | -----           | -----    |
| YTZ10S       | 920-142                         | 170.95 E | 360013                                | 73.95 G | 462002          | 149.95 B |
| YTZ12S       | 920-143                         | 184.95 E | 360016                                | 81.95 G | 462002          | 149.95 B |
| YTZ14S       | 920-144                         | 207.95 E | 360022                                | 92.95 G | 462002          | 149.95 B |



- accessories
- towables
- body
- controls
- electrical
- driveline
- engine
- fuel & intake
- chemicals
- tie downs
- tools
- towing & loading

MARINE



# ELECTRICAL

- accessories
- towables
- body
- controls
- electrical
- driveline
- engine
- fuel & intake
- chemicals
- tie downs
- tools
- towing & loading

# MARINE

| YUMICRON BATTERIES |                        |        |      |                           |        |      |  |        |                 |                 |
|--------------------|------------------------|--------|------|---------------------------|--------|------|--|--------|-----------------|-----------------|
| BATTERY TYPE       | YUASA YUMICRON 12 VOLT |        |      | YUASA YUMICRON CX-12 VOLT |        |      | POWER SONIC HIGH PERFORMANCE                     |        | DELTRAN LITHIUM |                 |
| YB2.5L-C           | 920-149                | 31.95  | E    | ----                      | ----   | ---- | 360052   | 18.95  | G               | ----            |
| YB2.5L-C-1         | 920-150                | 31.95  | E    | ----                      | ----   | ---- | 360053   | 18.95  | G               | ----            |
| YB3L-A             | 920-151                | 35.95  | E    | ----                      | ----   | ---- | 360054   | 21.95  | G               | ----            |
| YB3L-B             | 920-152                | 40.95  | E    | ----                      | ----   | ---- | 360055   | 21.95  | G               | ----            |
| YB4L-A             | 920-153                | 40.95  | E    | ----                      | ----   | ---- | 360056   | 23.95  | G               | 462001 99.95 B  |
| YB4L-B             | 920-154                | 27.95  | E    | ----                      | ----   | ---- | 360057   | 23.95  | G               | 462001 99.95 B  |
| YB5L-B             | 920-155                | 33.95  | E    | ----                      | ----   | ---- | 360058   | 25.95  | G               | 462001 99.95 B  |
| YB7-A              | 920-156                | 40.95  | E    | ----                      | ----   | ---- | 360059   | 35.95  | G               | 462001 99.95 B  |
| YB7B-B             | 920-157                | 47.95  | E    | ----                      | ----   | ---- | ----   | ----   | ----            | ----            |
| YB7C-A             | 920-158                | 49.95  | E    | ----                      | ----   | ---- | 360060   | 41.95  | G               | 462001 99.95 B  |
| YB7L-B             | 920-159                | 55.95  | E    | ----                      | ----   | ---- | 360061   | 41.95  | G               | 462001 99.95 B  |
| YB9A-A             | 920-160                | 54.95  | E    | ----                      | ----   | ---- | SO3210   | 43.95  | G               | ----            |
| YB9L-A2            | 920-161                | 67.95  | E    | ----                      | ----   | ---- | SO3214   | 39.95  | G               | 462002 149.95 B |
| YB9-B              | 920-162                | 49.95  | E    | ----                      | ----   | ---- | 360062   | 39.95  | G               | 462002 149.95 B |
| YB9L-B             | 920-163                | 49.95  | E    | ----                      | ----   | ---- | 360063   | 35.95  | G               | 462002 149.95 B |
| YB10A-A2           | 920-164                | 56.95  | E    | ----                      | ----   | ---- | SO3220   | 43.95  | G               | ----            |
| YB10L-A2           | 920-165                | 56.95  | E    | ----                      | ----   | ---- | SO2005   | 41.95  | G               | 462002 149.95 B |
| YB10L-B            | 920-166                | 62.95  | E    | ----                      | ----   | ---- | SO2010   | 47.95  | G               | 462002 149.95 B |
| YB10L-B2           | 920-167                | 62.95  | E    | ----                      | ----   | ---- | 360064   | 41.95  | G               | 462002 149.95 B |
| YB12A-A            | 920-168                | 55.95  | E    | ----                      | ----   | ---- | SO2012   | 42.95  | G               | 462001 99.95 B  |
| YB12AL-A           | 920-171                | 59.95  | E    | ----                      | ----   | ---- | 360065   | 42.95  | G               | 462002 149.95 B |
| YB12AL-A2          | 920-172                | 59.95  | E    | ----                      | ----   | ---- | 360066   | 43.95  | G               | 462002 149.95 B |
| YB12A-B            | 920-173                | 71.95  | E    | ----                      | ----   | ---- | 360067   | 50.95  | G               | ----            |
| YB12B-B2           | 920-174                | 77.95  | E    | ----                      | ----   | ---- | 360068   | 55.95  | G               | ----            |
| YB12C-A            | 920-175                | 60.95  | E    | ----                      | ----   | ---- | SO3224   | 43.95  | G               | ----            |
| YB14-A2            | 920-176                | 62.95  | E    | ----                      | ----   | ---- | SO2214   | 49.95  | G               | ----            |
| 14A-A              | ----                   | ----   | ---- | ----                      | ----   | ---- | SO3229   | 46.95  | G               | ----            |
| YB14A-A1           | 920-177                | 66.95  | E    | ----                      | ----   | ---- | ----   | ----   | ----            | ----            |
| YB14A-A2           | 920-178                | 62.95  | E    | ----                      | ----   | ---- | SO3234   | 46.95  | G               | ----            |
| YB14L-A1           | 920-179                | 70.95  | E    | ----                      | ----   | ---- | 360070   | 60.95  | G               | ----            |
| YB14L-A2           | 920-180                | 62.95  | E    | ----                      | ----   | ---- | SO2014   | 46.95  | G               | ----            |
| YB14L-A2 W/SENSOR  | 920-181                | 68.95  | E    | ----                      | ----   | ---- | 360072   | 67.95  | G               | ----            |
| YB14L-B2           | 920-182                | 71.95  | E    | ----                      | ----   | ---- | 360071   | ----   | ----            | ----            |
| YB14-B2            | 920-183                | 71.95  | E    | ----                      | ----   | ---- | 360067   | 50.95  | G               | ----            |
| SYB14L-A2          | 920-184                | 106.95 | E    | ----                      | ----   | ---- | 360072   | 67.95  | G               | ----            |
| YB16AL-A2          | 920-185                | 83.95  | E    | ----                      | ----   | ---- | SO3236   | 66.95  | G               | ----            |
| HYB16A-AB          | 920-186                | 99.95  | E    | ----                      | ----   | ---- | ----   | ----   | ----            | 462002 149.95 B |
| YB16-B             | 920-187                | 76.95  | E    | ----                      | ----   | ---- | 360074   | 67.95  | G               | 462004 229.95 B |
| YB16-B-CX          | ----                   | ----   | ---- | 920-146                   | 97.95  | E    | ----   | ----   | ----            | ----            |
| YB16L-B            | 920-188                | 81.95  | E    | ----                      | ----   | ---- | SO2016   | 67.95  | G               | ----            |
| YB16B-A            | 920-189                | 119.95 | E    | ----                      | ----   | ---- | 360075   | 84.95  | G               | ----            |
| YB16B-A1           | 920-190                | 118.95 | E    | ----                      | ----   | ---- | 360076   | 78.95  | G               | ----            |
| YB16C-B            | 920-191                | 96.95  | E    | ----                      | ----   | ---- | ----   | ----   | ----            | ----            |
| YB16CL-B           | 920-192                | 75.95  | E    | ----                      | ----   | ---- | SO3240   | 62.95  | G               | ----            |
| YB16HL-A-CX        | ----                   | ----   | ---- | 920-147                   | 96.95  | E    | ----   | ----   | ----            | ----            |
| YB18-A             | 920-193                | 84.95  | E    | ----                      | ----   | ---- | SO3281   | 72.95  | G               | ----            |
| YB18L-A            | 920-194                | 84.95  | E    | ----                      | ----   | ---- | 360078   | ----   | ----            | ----            |
| Y50-N18A-A         | 920-195                | 121.95 | E    | ----                      | ----   | ---- | 360079   | ----   | ----            | ----            |
| Y50-N18L-A         | 920-196                | 78.95  | E    | ----                      | ----   | ---- | ----   | ----   | ----            | ----            |
| Y50-N18L-A3        | 920-197                | 78.95  | E    | ----                      | ----   | ---- | SO2050   | 67.95  | G               | ----            |
| Y50-N18L-A3-CX     | ----                   | ----   | ---- | 920-148                   | 100.95 | E    | ----   | ----   | ----            | ----            |
| SY50-N18L-AT       | 920-198                | 92.95  | E    | ----                      | ----   | ---- | 360081   | 94.95  | G               | ----            |
| YB30L-B            | 920-203                | 114.95 | E    | ----                      | ----   | ---- | SO3290----                                       | 95.95  | G               | ----            |
| YB30CL-B           | 920-204                | 128.95 | E    | ----                      | ----   | ---- | SO3337   | 98.95  | G               | ----            |
| 51814              | 920-205                | 109.95 | E    | ----                      | ----   | ---- | 360084   | 84.95  | G               | 462002 149.95 B |
| 51913              | 920-206                | 97.95  | E    | ----                      | ----   | ---- | ----   | ----   | ----            | 462002 149.95 B |
| 53030              | 920-207                | 126.95 | E    | ----                      | ----   | ---- | 360086   | 109.95 | G               | ----            |
|                    | ACID NOT INCLUDED      |        |      | ACID NOT INCLUDED         |        |      | ACID PACKS INCLUDED IN ALL POWER SONIC BATTERIES |        |                 |                 |



| CONVENTIONAL 12 VOLT BATTERIES |   |         |       |  |        |  |                 |
|--------------------------------|---|---------|-------|--|--------|--|-----------------|
| BATTERY TYPE                   | <br>*ACID NOT INCLUDED |         |       | <br>*ACID PACKS INCLUDED IN ALL POWER SONIC BATTERIES |        |  |                 |
|                                | 12N5-3B   | 920-208 | 36.95 | E  | 360087 |  | 24.95           |
| 12N5-4B                        | 920-209   | 36.95   | E     | 360088   | 24.95  | G  | 462001 99.95 B  |
| 12N5.5-3B                      | 920-210   | 46.95   | E     | 360089   | 25.95  | G  | 462001 99.95 B  |
| 12N5.5-4A                      | 920-211   | 50.95   | E     | 360090   | 26.95  | G  | 462001 99.95 B  |
| 12N5.5A-3B                     | 920-212   | 39.95   | E     | 360091   | 28.95  | G  | 462001 99.95 B  |
| 12N7-3B                        | 920-213   | 42.95   | E     | 360092   | 36.95  | G  | ----            |
| 12N7-4A                        | 920-214   | 40.95   | E     | SO2274   | 36.95  | G  | ----            |
| 12N7-4B                        | 920-215   | 51.95   | E     | 360093   | 31.95  | G  | ----            |
| 12N7D-3B                       | 920-216   | 40.95   | E     | SO3228   | 30.95  | G  | ----            |
| 12N9-3A                        | 920-217   | 53.95   | E     | ----   | ----   | ----   | 462001 99.95 B  |
| 12N9-3B                        | 920-218   | 51.95   | E     | 360095   | 32.95  | G  | 462002 149.95 B |
| 12N9-4B-1                      | 920-219   | 38.95   | E     | SO1109   | 28.95  | G  | 462001 99.95 B  |
| 12N12A-4A-1                    | 920-222   | 46.95   | E     | SO1112   | 35.95  | G  | ----            |
| 12N14-3A                       | 920-223   | 46.95   | E     | SO1114   | 37.95  | G  | ----            |
| 12N24-3A                       | 920-224   | 97.95   | E     | ----   | ----   | ----   | ----            |
| 12N24-3                        | 920-225   | 104.95  | E     | ----   | ----   | ----   | ----            |
| YHD-12H                        | 920-226   | 117.95  | E     | ----   | ----   | ----   | 462002 149.95 B |



- accessories
- towables
- body
- controls
- electrical
- driveline
- engine
- fuel & intake
- chemicals
- tie downs
- tools
- towing & loading

BATTERY CROSS REFERENCE CHART

| FACTORY ACTIVATED MAINTENANCE FREE | HIGH PERFORMANCE MAINTENANCE FREE | MAINTENANCE FREE VRLA  | YUMICRON CX   | YUMICRON           | CONVENTIONAL        |
|------------------------------------|-----------------------------------|------------------------|---------------|--------------------|---------------------|
| -                                  | -                                 | -                      | -             | 6YB11-2D           | 6N11-2D             |
| -                                  | YTX4L-BS                          | YT4L-BS (Discontinued) | -             | YB4L-A, YB4L-B     | -                   |
| YTZ7S                              | YTX5L-BS                          | YT5L-BS (Discontinued) | -             | -                  | -                   |
| -                                  | -                                 | -                      | -             | YB5L-B             | 12N5-3B             |
| -                                  | -                                 | -                      | -             | YB7L-B             | 12N7-3B             |
| -                                  | -                                 | -                      | -             | YB7-A              | 12N7-4A             |
| -                                  | -                                 | -                      | -             | YB9-B              | 12N9-4B-1           |
| -                                  | -                                 | -                      | -             | YB9L-B             | 12N9-3B             |
| -                                  | -                                 | -                      | -             | YB10L-A2           | 12N10-3A-2          |
| -                                  | -                                 | -                      | -             | YB12A-A            | 12N12A-4A-1         |
| YTX14H                             | YTX14H-BS                         | YTX14-BS               | -             | -                  | -                   |
| YTX14AH                            | YTX14AH-BS                        | -                      | -             | YB14-A2, YB14-B2   | -                   |
| YTX14AH †††                        | YTX14AH-BS †††                    | -                      | -             | YB14A-A1, YB14A-A2 | -                   |
| YTX14AHL                           | YTX14AHL-BS                       | -                      | -             | YB14L-A2           | 12N14-3A            |
| YTX14AHL                           | YTX14AHL-BS                       | -                      | -             | YB14L-B2           | -                   |
| -                                  | YTX20CH-BS                        | YTX16-BS               | -             | -                  | -                   |
| YTX20H, YTX20 ‡                    | YTX20H-BS ‡                       | YTX20-BS ‡             | YB16-B-CX     | YB16-B             | -                   |
| YTX20H, YTX20 ‡                    | YTX20H-BS ‡                       | YTX20-BS ‡             | -             | YB18-A             | -                   |
| YTX20HL-PW S                       | YTX20HL-BS-PW S                   | -                      | -             | YB16CL-B           | -                   |
| YTX20HL, YTX20L C                  | YTX20HL-BS C                      | YTX20L-BS C            | YB16HL-A-CX   | -                  | -                   |
| YTX20HL, YTX20L ‡                  | YTX20HL-BS ‡                      | YTX20L-BS ‡            | -             | YB16L-B            | -                   |
| YTX20HL, YTX20L ‡                  | YTX20HL-BS ‡                      | YTX20L-BS ‡            | -             | YB18L-A            | -                   |
| GYZ20L                             | YTX20HL-BS ‡                      | YTX20L-BS              | -             | -                  | -                   |
| YTX24HL ††                         | YTX24HL-BS ††                     | -                      | Y50-N18L-A-CX | Y50-N18L-A         | -                   |
| YTX24HL                            | YTX24HL-BS                        | -                      | -             | Y50-N18L-A3        | -                   |
| YTX24HL †† (1)                     | YTX24HL-BS †† (1)                 | -                      | -             | SY50-N18L-AT       | -                   |
| YIX30L                             | -                                 | -                      | -             | YB30L-B            | -                   |
| YIX30L                             | -                                 | -                      | -             | 53030              | Y60-N24AL-B (disc.) |

VRLA Valve Regulated Lead Acid.

††† Includes 10mm spacer for use in replacing YB14A-A1 and YB14A-A2.

S Includes 20mm spacer for use in replacing YB16CL-B.

C Requires use of Yuasa Cover/Spacer Kit part no. 478651

‡ The YTX20 series batteries may be used as an optional upgrade, but some modification to the hold down may be necessary.

See label for retrofit cautions.

†† Top and front terminal mounts only.

(1) Eliminates need for sensor (needs to be disabled).

MARINE

## BATTERY SPECIFICATIONS

### HIGH PERFORMANCE, MAINTENANCE FREE BATTERY SPECIFICATIONS - 12 VOLT

| BATTERY TYPE   |    | CAPACITY<br>AH (10H-R) | DIMENSIONS - INCHES<br>(+/- 1/16 IN) |        |        | DIMENSIONS - MM<br>(+/- 2 MM) |    |     | WEIGHT<br>W/O<br>ACID<br>LBS | TERMINAL<br>TYPE | ACID<br>VOL.<br>LITERS | REGULAR<br>CHARGE<br>CURRENT<br>AMP | C.C.A. @<br>0° F<br>(-18° C) |
|----------------|----|------------------------|--------------------------------------|--------|--------|-------------------------------|----|-----|------------------------------|------------------|------------------------|-------------------------------------|------------------------------|
|                |    |                        | L                                    | W      | H      | L                             | W  | H   |                              |                  |                        |                                     |                              |
| YTX14AH-BS ‡‡‡ | FA | 12                     | 5 5/16                               | 3 1/2  | 6 9/16 | 134                           | 89 | 166 | 9.0                          | 4                | 0.66                   | 1.2                                 | 210                          |
| YTX14AHL-BS    | FA | 12                     | 5 5/16                               | 3 1/2  | 6 9/16 | 134                           | 89 | 166 | 9.0                          | 4                | 0.66                   | 1.2                                 | 210                          |
| YTX14H-BS      | FA | 12                     | 6                                    | 3 7/16 | 5 3/4  | 150                           | 87 | 145 | 8.6                          | 4                | 0.69                   | 1.2                                 | 260                          |
| YTX20CH-BS     |    | 18                     | 6                                    | 3 7/16 | 6 3/8  | 150                           | 87 | 161 | 11.0                         | 4                | 0.82                   | 1.8                                 | 270                          |
| YTX20H-BS      | FA | 18                     | 6 7/8                                | 3 7/16 | 6 1/8  | 175                           | 87 | 155 | 12.4                         | 4                | 0.93                   | 1.8                                 | 310                          |
| YTX20HL-BS     | FA | 18                     | 6 7/8                                | 3 7/16 | 6 1/8  | 175                           | 87 | 155 | 12.4                         | 4                | 0.93                   | 1.8                                 | 310                          |
| YTX20HL-BS-PW  | FA | 18                     | 6 7/8                                | 3 7/16 | 6 7/8  | 175                           | 87 | 175 | 12.4                         | 4                | 0.93                   | 1.8                                 | 310                          |
| YTX24HL-BS     | FA | 21                     | 8 1/8                                | 3 7/16 | 6 3/8  | 205                           | 87 | 162 | 14.4                         | 4                | 0.99                   | 2.1                                 | 350                          |

### FACTORY ACTIVATED MAINTENANCE FREE BATTERY SPECIFICATIONS - 12 VOLT

| BATTERY TYPE |    | CAPACITY<br>AH (10H-R) | DIMENSIONS - INCHES<br>(+/- 1/16 IN) |         |         | DIMENSIONS - MM<br>(+/- 2 MM) |     |      | WEIGHT<br>W/O<br>ACID<br>LBS | TERMINAL<br>TYPE | ACID<br>VOL.<br>LITERS | REGULAR<br>CHARGE<br>CURRENT<br>AMP | C.C.A. @<br>0° F<br>(-18° C) |
|--------------|----|------------------------|--------------------------------------|---------|---------|-------------------------------|-----|------|------------------------------|------------------|------------------------|-------------------------------------|------------------------------|
|              |    |                        | L                                    | W       | H       | L                             | W   | H    |                              |                  |                        |                                     |                              |
| YTZ7S        |    | 6                      | 4 7/16                               | 2 3/4   | 4 1/8   | 113                           | 70  | 105  | 4.6                          | 5                | N/A                    | 0.6                                 | 130                          |
| YTZ10S       |    | 8.6                    | 6                                    | 3 7/16  | 3 11/16 | 150                           | 87  | 93   | 7.0                          | 11               | N/A                    | 0.9                                 | 190                          |
| YTZ12S       |    | 11                     | 6                                    | 3 7/16  | 4 3/8   | 150                           | 87  | 110  | 8.1                          | 11               | N/A                    | 1.1                                 | 210                          |
| YTZ14S       |    | 11.2                   | 6                                    | 3 7/16  | 4 3/8   | 150                           | 87  | 110  | 8.6                          | 11               | N/A                    | 1.1                                 | 230                          |
| GYZ20L       |    | 18                     | 6 7/8                                | 3 7/16  | 6 1/8   | 175                           | 87  | 155  | 15.2                         | 4                | N/A                    | 1.8                                 | 270                          |
| YIX30L       | FA | 30                     | 6 1/4                                | 5       | 7 1/2   | 166                           | 126 | 175  | 22.0                         | 5                | N/A                    | 3.0                                 | 385                          |
| TR4A-BS      |    | 2.3                    | 4 1/2                                | 1 15/16 | 3 3/8   | 114                           | 49  | 86   | 2.0                          | 12               | 0.14                   | 0.3                                 | 45                           |
| YT4B-BS      |    | 2.3                    | 4 1/2                                | 1 9/16  | 3 7/16  | 114                           | 39  | 86.5 | 2.1                          | 13               | 0.12                   | 0.3                                 | 40                           |
| YTX4L-BS     |    | 3                      | 4 1/2                                | 2 13/16 | 3 3/8   | 114                           | 71  | 86   | 2.9                          | 5                | 0.18                   | 0.4                                 | 50                           |
| YTX5L-BS     |    | 4                      | 4 1/2                                | 2 13/16 | 4 3/16  | 114                           | 71  | 106  | 3.5                          | 5                | 0.24                   | 0.5                                 | 70                           |
| YT7B-BS      |    | 6.5                    | 6                                    | 2 9/16  | 3 11/16 | 150                           | 65  | 93   | 5.0                          | 11               | 0.33                   | 0.7                                 | 85                           |
| YTX7A-BS     |    | 6                      | 6                                    | 3 7/16  | 3 3/4   | 150                           | 87  | 94   | 5.3                          | 5                | 0.33                   | 0.7                                 | 90                           |
| YTX7L-BS     |    | 6                      | 4 1/2                                | 2 13/16 | 5 3/16  | 114                           | 71  | 131  | 5.1                          | 5                | 0.33                   | 0.6                                 | 85                           |
| YT9B-BS      |    | 8                      | 6                                    | 2 3/4   | 4 1/8   | 150                           | 70  | 105  | 7.5                          | 11               | 0.4                    | 0.8                                 | 115                          |
| YTX9-BS      | FA | 8                      | 6                                    | 3 7/16  | 4 3/16  | 150                           | 87  | 105  | 5.4                          | 5                | 0.40                   | 0.9                                 | 120                          |
| YT12A-BS     |    | 9.5                    | 6                                    | 3 7/16  | 4 3/16  | 150                           | 87  | 105  | 6.3                          | 5                | 0.47                   | 1.0                                 | 175                          |
| YT12B-BS     |    | 10                     | 6                                    | 2 3/4   | 5 1/8   | 150                           | 69  | 130  | 7.6                          | 11               | 0.52                   | 1.0                                 | 125                          |
| YTX12-BS     | FA | 10                     | 6                                    | 3 7/16  | 5 1/8   | 150                           | 87  | 130  | 7.5                          | 5                | 0.60                   | 1.2                                 | 180                          |
| KMX14-BS K   |    | 12                     | 6                                    | 3 7/16  | 5 3/4   | 150                           | 87  | 145  | 8.1                          | 5                | 0.69                   | 1.4                                 | 200                          |
| YT14B-BS     |    | 12                     | 6 1/8                                | 2 3/4   | 5 3/4   | 152                           | 70  | 145  | 10.1                         | 11               | 0.60                   | 1.2                                 | 210                          |
| YTX14-BS     | FA | 12                     | 6                                    | 3 7/16  | 5 3/4   | 150                           | 87  | 145  | 8.1                          | 5                | 0.69                   | 1.4                                 | 200                          |
| YTX14L-BS    | FA | 12                     | 6                                    | 3 7/16  | 5 3/4   | 150                           | 87  | 145  | 8.1                          | 5                | 0.69                   | 1.4                                 | 200                          |
| YTX15L-BS    |    | 13                     | 6 7/8                                | 3 7/16  | 5 1/8   | 175                           | 87  | 130  | 8.8                          | 4                | 0.69                   | 1.3                                 | 230                          |
| YTX16-BS     |    | 14                     | 6                                    | 3 7/16  | 6 3/8   | 150                           | 87  | 161  | 10.3                         | 4                | 0.78                   | 1.4                                 | 230                          |
| YTX16-BS-1   |    | 14                     | 6                                    | 3 7/16  | 6 3/8   | 150                           | 87  | 161  | 10.3                         | 1                | 0.78                   | 1.4                                 | 230                          |
| YTX20-BS     | FA | 18                     | 6 7/8                                | 3 7/16  | 6 1/8   | 175                           | 87  | 155  | 11.2                         | 4                | 0.93                   | 1.8                                 | 270                          |
| YTX20L-BS    | FA | 18                     | 6 7/8                                | 3 7/16  | 6 1/8   | 175                           | 87  | 155  | 11.2                         | 4                | 0.93                   | 1.8                                 | 270                          |

### YUMICRON CX BATTERY SPECIFICATIONS - 12 VOLT

| BATTERY TYPE  |  | CAPACITY<br>AH (10H-R) | DIMENSIONS - INCHES<br>(+/- 1/16 IN) |        |       | DIMENSIONS - MM<br>(+/- 2 MM) |     |     | WEIGHT<br>W/O<br>ACID<br>LBS | TERMINAL<br>TYPE | ACID<br>VOL.<br>OUNCES | REGULAR<br>CHARGE<br>CURRENT<br>AMP | C.C.A. @<br>0° F<br>(-18° C) |
|---------------|--|------------------------|--------------------------------------|--------|-------|-------------------------------|-----|-----|------------------------------|------------------|------------------------|-------------------------------------|------------------------------|
|               |  |                        | L                                    | W      | H     | L                             | W   | H   |                              |                  |                        |                                     |                              |
| YB16-B-CX     |  | 19                     | 6 7/8                                | 4      | 6 1/8 | 175                           | 100 | 155 | 10.5                         | 6                | 40.6                   | 1.9                                 | -                            |
| YB16HL-A-CX   |  | 19                     | 6 7/8                                | 4      | 6 1/8 | 175                           | 100 | 155 | 10.5                         | 6                | 40.6                   | 1.9                                 | -                            |
| Y50-N18L-A-CX |  | 20                     | 8 1/8                                | 3 9/16 | 6 3/8 | 205                           | 90  | 162 | 11.2                         | 7                | 47.3                   | 2.0                                 | -                            |

### YUMICRON BATTERY SPECIFICATIONS -12 VOLT

- accessories
- towables
- body
- controls
- electrical
- driveline
- engine
- fuel & intake
- chemicals
- tie downs
- tools
- towing & loading

## YUASA BATTERY SPECIFICATIONS CONTINUED

| BATTERY TYPE         | CAPACITY<br>AH<br>(10H-R) | DIMENSIONS - INCHES<br>(+/- 1/16 IN) |         |         | DIMENSIONS - MM<br>(+/- 2 MM) |      |     | WEIGHT<br>W/O<br>ACID<br>LBS | TERMINAL<br>TYPE | ACID<br>VOL.<br>OUNCES | REGULAR<br>CHARGE<br>CURRENT<br>AMP | C.C.A. @<br>0° F<br>(-18° C) |
|----------------------|---------------------------|--------------------------------------|---------|---------|-------------------------------|------|-----|------------------------------|------------------|------------------------|-------------------------------------|------------------------------|
|                      |                           | L                                    | W       | H       | L                             | W    | H   |                              |                  |                        |                                     |                              |
| YB2.5L-C             | 2.5                       | 3 3/16                               | 2 3/4   | 4 1/8   | 80                            | 70   | 105 | 1.7                          | -                | 8.1                    | 0.3                                 | -                            |
| YB2.5L-C-1           | 2.5                       | 3 3/16                               | 2 3/4   | 4 1/8   | 80                            | 70   | 105 | 1.7                          | -                | 8.1                    | 0.3                                 | -                            |
| YB3L-A               | 3                         | 3 7/8                                | 2 1/4   | 4 3/8   | 98                            | 56   | 110 | 2.5                          | 6                | 8.1                    | 0.3                                 | -                            |
| YB3L-B               | 3                         | 3 7/8                                | 2 1/4   | 4 3/8   | 98                            | 56   | 110 | 2.5                          | 6                | 8.1                    | 0.3                                 | -                            |
| YB4L-A               | 4                         | 4 3/4                                | 2 3/4   | 3 5/8   | 120                           | 70   | 92  | 2.8                          | 5                | 10.1                   | 0.4                                 | -                            |
| YB4L-B               | 4                         | 4 3/4                                | 2 3/4   | 3 5/8   | 120                           | 70   | 92  | 2.8                          | 5                | 10.1                   | 0.4                                 | -                            |
| YB5L-B               | 5                         | 4 3/4                                | 2 3/8   | 5 1/8   | 120                           | 60   | 130 | 3.5                          | 6                | 12.2                   | 0.5                                 | -                            |
| YB7-A                | 8                         | 5 5/16                               | 3       | 5 1/4   | 135                           | 75   | 133 | 5.1                          | 6                | 20.3                   | 0.8                                 | -                            |
| YB7B-B               | 7                         | 6                                    | 2 3/8   | 5 1/8   | 150                           | 60   | 130 | 4.0                          | 6                | 16.9                   | 0.7                                 | -                            |
| YB7C-A               | 8                         | 5 1/8                                | 3 9/16  | 4 1/2   | 130                           | 90   | 114 | 5.1                          | 3                | 20.3                   | 0.8                                 | -                            |
| YB7L-B               | 8                         | 5 5/16                               | 3       | 5 1/4   | 135                           | 75   | 133 | 5.1                          | 6                | 20.3                   | 0.8                                 | -                            |
| YB9A-A               | 9                         | 5 5/16                               | 3       | 6 1/8   | 135                           | 75   | 155 | 5.3                          | 6                | 20.3                   | 0.9                                 | -                            |
| YB9L-A2              | 9                         | 5 5/16                               | 3       | 5 1/2   | 135                           | 75   | 139 | 5.3                          | 2                | 20.3                   | 0.9                                 | -                            |
| YB9-B                | 9                         | 5 5/16                               | 3       | 5 1/2   | 135                           | 75   | 139 | 5.3                          | 6                | 20.3                   | 0.9                                 | -                            |
| YB9L-B               | 9                         | 5 5/16                               | 3       | 5 1/2   | 135                           | 75   | 139 | 5.3                          | 6                | 20.3                   | 0.9                                 | -                            |
| YB10A-A2             | 11                        | 5 5/16                               | 3 9/16  | 6 1/8   | 135                           | 90   | 155 | 7.0                          | 8                | 27.0                   | 1.1                                 | -                            |
| YB10L-A2             | 11                        | 5 5/16                               | 3 9/16  | 5 3/4   | 135                           | 90   | 145 | 7.0                          | 8                | 27.0                   | 1.1                                 | -                            |
| YB10L-B              | 11                        | 5 5/16                               | 3 9/16  | 5 3/4   | 135                           | 90   | 145 | 7.0                          | 6                | 27.0                   | 1.1                                 | -                            |
| YB10L-B2             | 11                        | 5 5/16                               | 3 9/16  | 5 3/4   | 135                           | 90   | 145 | 7.0                          | 8                | 27.0                   | 1.1                                 | -                            |
| YB12A-A              | 12                        | 5 5/16                               | 3 3/16  | 6 5/16  | 134                           | 80   | 160 | 6.8                          | 6                | 27.0                   | 1.2                                 | -                            |
| YB12A-A W/S †        | 12                        | 5 5/16                               | 3 3/16  | 6 5/16  | 134                           | 80   | 160 | 6.8                          | 6                | 27.0                   | 1.2                                 | -                            |
| YB12A-A W/TA **      | 12                        | 5 5/16                               | 3 3/16  | 6 5/16  | 134                           | 80   | 160 | 6.8                          | 6                | 27.0                   | 1.2                                 | -                            |
| YB12AL-A W/<br>TA D1 | 12                        | 5 5/16                               | 3 3/16  | 6 5/16  | 134                           | 80   | 160 | 6.8                          | 6                | 25.4                   | 1.2                                 | -                            |
| YB12AL-A             | 12                        | 5 5/16                               | 3 3/16  | 6 5/16  | 134                           | 80   | 160 | 6.8                          | 6                | 25.4                   | 1.2                                 | -                            |
| YB12AL-A2 *          | 12                        | 5 5/16                               | 3 3/16  | 6 5/16  | 134                           | 80   | 160 | 6.8                          | 8                | 25.4                   | 1.2                                 | -                            |
| YB12A-B              | 12                        | 5 5/16                               | 3 3/16  | 6 5/16  | 134                           | 80   | 160 | 6.8                          | 6                | 25.4                   | 1.2                                 | -                            |
| YB12B-B2             | 12                        | 6 5/16                               | 3 9/16  | 5 1/8   | 160                           | 90   | 130 | 7.1                          | 8                | 27.0                   | 1.2                                 | -                            |
| YB12C-A              | 12                        | 5 5/16                               | 3 3/16  | 6 7/8   | 134                           | 80   | 175 | 7.1                          | 4                | 27.0                   | 1.2                                 | -                            |
| YB14-A2              | 14                        | 5 5/16                               | 3 1/2   | 6 9/16  | 134                           | 89   | 166 | 7.6                          | 8                | 30.4                   | 1.4                                 | -                            |
| YB14A-A1             | 14                        | 5 5/16                               | 3 1/2   | 6 15/16 | 134                           | 89   | 176 | 7.9                          | 6                | 30.4                   | 1.4                                 | -                            |
| YB14A-A2             | 14                        | 5 5/16                               | 3 1/2   | 6 15/16 | 134                           | 89   | 176 | 7.9                          | 8                | 30.4                   | 1.4                                 | -                            |
| YB14L-A1             | 14                        | 5 5/16                               | 3 1/2   | 6 9/16  | 134                           | 89   | 166 | 7.6                          | 1                | 30.4                   | 1.4                                 | -                            |
| YB14L-A2             | 14                        | 5 5/16                               | 3 1/2   | 6 9/16  | 134                           | 89   | 166 | 7.6                          | 8                | 30.4                   | 1.4                                 | -                            |
| YB14L-A2 W/S †       | 14                        | 5 5/16                               | 3 1/2   | 6 9/16  | 134                           | 89   | 166 | 7.6                          | 8                | 30.4                   | 1.4                                 | -                            |
| YB14L-B2             | 14                        | 5 5/16                               | 3 1/2   | 6 9/16  | 134                           | 89   | 166 | 7.6                          | 8                | 30.4                   | 1.4                                 | -                            |
| YB14-B2              | 14                        | 5 5/16                               | 3 1/2   | 6 9/16  | 134                           | 89   | 166 | 7.6                          | 8                | 30.4                   | 1.4                                 | -                            |
| SYB14L-A2 #          | 14                        | 5 5/16                               | 3 1/2   | 6 9/16  | 134                           | 89   | 166 | 7.6                          | 8                | 30.4                   | 1.4                                 | -                            |
| SYB14L-B2 #          | 14                        | 5 5/16                               | 3 1/2   | 6 9/16  | 134                           | 89   | 166 | 7.6                          | 8                | 30.4                   | 1.4                                 | -                            |
| YB16AL-A2            | 16                        | 8 1/8                                | 2 13/16 | 6 7/16  | 207                           | 71.5 | 164 | 8.6                          | 2                | 37.2                   | 1.6                                 | -                            |
| HYB16A-AB            | 16                        | 6                                    | 3 5/8   | 7 1/16  | 151                           | 91   | 180 | 8.5                          | 7                | 30.4                   | 1.6                                 | -                            |
| YB16-B               | 19                        | 6 7/8                                | 4       | 6 1/8   | 175                           | 100  | 155 | 10.5                         | 6                | 40.6                   | 1.9                                 | -                            |
| YB16L-B              | 19                        | 6 7/8                                | 4       | 6 1/8   | 175                           | 100  | 155 | 10.5                         | 6                | 40.6                   | 1.9                                 | -                            |
| YB16B-A              | 16                        | 6 5/16                               | 3 9/16  | 6 3/8   | 160                           | 90   | 161 | 8.4                          | 4                | 33.8                   | 1.6                                 | -                            |
| YB16B-A1 *           | 16                        | 6 5/16                               | 3 9/16  | 6 3/8   | 160                           | 90   | 161 | 8.4                          | 7                | 33.8                   | 1.6                                 | -                            |
| YB16C-B              | 19                        | 6 7/8                                | 4       | 6 7/8   | 175                           | 100  | 175 | 10.1                         | 5                | 40.6                   | 1.9                                 | -                            |
| YB16CL-B             | 19                        | 6 7/8                                | 4       | 6 7/8   | 175                           | 100  | 175 | 10.1                         | 5                | 40.6                   | 1.9                                 | -                            |
| SYB16L-B # D2        | 19                        | 6 15/16                              | 4       | 6 1/8   | 175                           | 100  | 155 | 9.3                          | 6                | 43.9                   | 1.9                                 | -                            |
| YB18-A               | 18                        | 7 1/8                                | 3 9/16  | 6 3/8   | 180                           | 90   | 162 | 9.4                          | 7                | 40.6                   | 1.8                                 | -                            |
| YB18L-A              | 18                        | 7 1/8                                | 3 9/16  | 6 3/8   | 180                           | 90   | 162 | 9.4                          | 7                | 40.6                   | 1.8                                 | -                            |
| Y50-N18A-A           | 20                        | 8 1/8                                | 3 9/16  | 6 15/16 | 205                           | 90   | 176 | 11.2                         | 7                | 50.7                   | 2.0                                 | -                            |
| Y50-N18L-A           | 20                        | 8 1/8                                | 3 9/16  | 6 3/8   | 205                           | 90   | 162 | 11.2                         | 7                | 47.3                   | 2.0                                 | -                            |
| Y50-N18L-A3          | 20                        | 8 1/8                                | 3 9/16  | 6 3/8   | 205                           | 90   | 162 | 11.2                         | 4                | 47.3                   | 2.0                                 | -                            |
| SY50-N18L-AT #       | 20                        | 8 1/8                                | 3 9/16  | 6 3/8   | 205                           | 90   | 162 | 11.2                         | 7                | 47.3                   | 2.0                                 | -                            |

YUMICRON BATTERY SPECIFICATIONS -12 VOLT

- accessories
- towables
- body
- controls
- electrical
- driveline
- engine
- fuel & intake
- chemicals
- tie downs
- tools
- towing & loading

MARINE

## BATTERY SPECIFICATIONS CONTINUED

| BATTERY TYPE   | CAPACITY AH (10H-R) | DIMENSIONS - INCHES (+/- 1/16 IN) |        |         | DIMENSIONS - MM (+/- 2 MM) |     |     | WEIGHT W/O ACID LBS | TERMINAL TYPE | ACID VOL. OUNCES | REGULAR CHARGE CURRENT AMP | C.C.A. @ 0° F (-18° C) |
|----------------|---------------------|-----------------------------------|--------|---------|----------------------------|-----|-----|---------------------|---------------|------------------|----------------------------|------------------------|
|                |                     | L                                 | W      | H       | L                          | W   | H   |                     |               |                  |                            |                        |
| Y60-N24-A      | 28                  | 7 1/4                             | 4 7/8  | 6 7/8   | 184                        | 124 | 175 | 14.4                | 3             | 57.5             | 2.8                        | -                      |
| Y60-N24AL-B D3 | 28                  | 7 1/4                             | 4 7/8  | 6 7/8   | 184                        | 124 | 175 | 14.4                | 3             | 57.5             | 2.8                        | -                      |
| YB30L-B        | 30                  | 6 5/8                             | 5 3/16 | 6 15/16 | 168                        | 132 | 176 | 14.1                | 4             | 57.5             | 3.0                        | -                      |
| YB30CL-B       | 30                  | 6 5/8                             | 5 3/16 | 7 9/16  | 168                        | 132 | 192 | 14.5                | 4             | 57.5             | 3.0                        | -                      |
| 51814          | *** 19              | 7 7/16                            | 3 1/4  | 6 7/8   | 186                        | 82  | 171 | 9.4                 | 10            | 33.8             | 1.9                        | -                      |
| 51913          | *** 19              | 7 7/16                            | 3 1/4  | 6 7/8   | 186                        | 82  | 171 | 9.4                 | 10            | 33.8             | 1.9                        | -                      |
| 53030          | *** 30              | 7 7/16                            | 5 1/8  | 6 7/8   | 186                        | 130 | 171 | 16.1                | 10            | 54.1             | 3.0                        | -                      |

### CONVENTIONAL BATTERY SPECIFICATIONS - 12 VOLT

| BATTERY TYPE  | CAPACITY AH (10H-R) | DIMENSIONS - INCHES (+/- 1/16 IN) |        |         | DIMENSIONS - MM (+/- 2 MM) |     |     | WEIGHT W/O ACID LBS | TERMINAL TYPE | ACID VOL. OUNCES | REGULAR CHARGE CURRENT AMP | C.C.A. @ 0° F (-18° C) |
|---------------|---------------------|-----------------------------------|--------|---------|----------------------------|-----|-----|---------------------|---------------|------------------|----------------------------|------------------------|
|               |                     | L                                 | W      | H       | L                          | W   | H   |                     |               |                  |                            |                        |
| 12N5-3B       | 5                   | 4 3/4                             | 2 3/8  | 5 1/8   | 120                        | 60  | 130 | 3.1                 | 6             | 13.5             | 0.5                        | -                      |
| 12N5-4B       | 5                   | 4 3/4                             | 2 3/8  | 5 1/8   | 120                        | 60  | 130 | 3.1                 | 6             | 13.5             | 0.5                        | -                      |
| 12N5.5-3B     | 5.5                 | 5 5/16                            | 2 3/8  | 5 1/8   | 135                        | 60  | 130 | 4.3                 | 6             | 13.5             | 0.6                        | -                      |
| 12N5.5-4A     | 5.5                 | 5 5/16                            | 2 3/8  | 5 1/8   | 135                        | 60  | 130 | 4.3                 | 2             | 13.5             | 0.6                        | -                      |
| 12N5.5A-3B    | 5.5                 | 4 1/16                            | 3 9/16 | 4 1/2   | 103                        | 90  | 114 | 4.3                 | 6             | 16.9             | 0.6                        | -                      |
| 12N7-3B       | 7                   | 5 5/16                            | 3      | 5 1/4   | 135                        | 75  | 133 | 4.9                 | 6             | 16.9             | 0.7                        | -                      |
| 12N7-4A       | 7                   | 5 5/16                            | 3      | 5 1/4   | 135                        | 75  | 133 | 4.9                 | 6             | 16.9             | 0.7                        | -                      |
| 12N7-4B       | 7                   | 5 5/16                            | 3      | 5 1/4   | 135                        | 75  | 133 | 4.9                 | 6             | 16.9             | 0.7                        | -                      |
| 12N7D-3B      | 7                   | 5 5/16                            | 3      | 5 15/16 | 135                        | 75  | 150 | 4.9                 | 6             | 20.3             | 0.7                        | -                      |
| 12N9-3A       | 9                   | 5 5/16                            | 3      | 5 1/2   | 135                        | 75  | 139 | 5.4                 | 9             | 20.3             | 0.9                        | -                      |
| 12N9-3A-1 D4  | 9                   | 5 5/16                            | 3      | 5 1/2   | 135                        | 75  | 139 | 5.4                 | 6             | 20.3             | 0.9                        | -                      |
| 12N9-3B       | 9                   | 5 5/16                            | 3      | 5 1/2   | 135                        | 75  | 139 | 5.4                 | 6             | 20.3             | 0.9                        | -                      |
| 12N9-4B-1     | 9                   | 5 5/16                            | 3      | 5 1/2   | 135                        | 75  | 139 | 5.4                 | 6             | 20.3             | 0.9                        | -                      |
| 12N10-3A D5   | 10                  | 5 5/16                            | 3 9/16 | 5 3/4   | 135                        | 90  | 145 | 6.4                 | 6             | 27.0             | 1.0                        | -                      |
| 12N10-3A-1 D5 | 10                  | 5 5/16                            | 3 9/16 | 5 3/4   | 135                        | 90  | 145 | 6.4                 | 6             | 27.0             | 1.0                        | -                      |
| 12N10-3A-2    | 10                  | 5 5/16                            | 3 9/16 | 5 3/4   | 135                        | 90  | 145 | 5.8                 | 8             | 27.0             | 1.0                        | -                      |
| 12N11-3A-1    | 11                  | 5 5/16                            | 3 9/16 | 6 1/8   | 135                        | 90  | 155 | 7.5                 | 8             | 27.0             | 1.1                        | -                      |
| 12N12A-4A-1   | 12                  | 5 5/16                            | 3 3/16 | 6 5/16  | 134                        | 80  | 160 | 6.8                 | 6             | 23.7             | 1.2                        | -                      |
| 12N14-3A      | 14                  | 5 5/16                            | 3 1/2  | 6 9/16  | 134                        | 89  | 166 | 7.5                 | 8             | 27.0             | 1.4                        | -                      |
| 12N24-3A      | 24                  | 7 1/4                             | 4 7/8  | 6 7/8   | 184                        | 124 | 175 | 12.1                | 3             | 40.6             | 2.4                        | -                      |
| 12N24-3       | 24                  | 7 1/4                             | 4 7/8  | 6 7/8   | 184                        | 124 | 175 | 12.1                | 3             | 40.6             | 2.4                        | -                      |
| YHD-12H       | 29                  | 8 1/8                             | 5 1/4  | 6 1/2   | 206                        | 133 | 165 | 13.3                | 9             | 74.4             | 2.8                        | -                      |

FA ALSO AVAILABLE FACTORY ACTIVATED. DROP "-BS" FROM PART NO.

‡‡‡ INCLUDES 10MM SPACER FOR ADDITIONAL HEIGHT REQUIRED IN REPLACING YB14A-A1 AND YB14A-A2.

S HEIGHT WITH 20MM SPACER INCLUDED FOR USE IN REPLACING YB16CL-B.

K AVAILABLE AT KAWASAKI DEALERS ONLY.

† WHEN ORDERING THIS BATTERY, SPECIFY SENSOR.

# THIS BATTERY INCLUDES A SENSOR.

\* INCLUDES TERMINAL ADAPTOR FOR CONVERTING TO TOP MOUNT.

\*\* WHEN ORDERING THIS BATTERY, SPECIFY TERMINAL ADAPTOR.

\*\*\* @ 20 HR. RATE.

\*\*\*\* TEST RESULTS NOT AVAILABLE AT DATE OF PRINTING - VALUE IS THEORETICAL.

## YUMICRON BATTERY CROSS REFERENCE CHART

Terminal shapes vary from one battery to another. By identifying the correct replacement battery from the following application, you are assured of the proper terminal configuration. For custom applications, refer to the chart below to identify terminal shape and corresponding batteries.

| Type      | Terminal |      |     | Battery Type   |  |  |  |  |
|-----------|----------|------|-----|--|--|--|--|--|
|           | Front    | Side | Top |  |  |  |  |  |
| <b>1</b>  |          |      |     | YB14L-A1<br>YTX16-BS-1   |  |  |  |  |
| <b>2</b>  |          |      |     | YB9L-A2<br>12N5.5-4A<br>YB16AL-A2  |  |  |  |  |
| <b>3</b>  |          |      |     | YB7C-A<br>12N24-3<br>YB0-N24AL-B<br>12N24-3A<br>YB0-N24-A  |  |  |  |  |
| <b>4</b>  |          |      |     | YB12C-A<br>YTX14L-BS<br>YTX20CH-BS<br>YTX20HL-BS-PW<br>YB16B-A<br>YTX14H-BS<br>YTX20-BS<br>YTX24HL-BS<br>Y50-N18L-A3<br>YTX14AH-BS<br>YTX20L-BS<br>GY220L<br>YB30L-B<br>YTX14AHL-B<br>YTX20H-BS<br>YB30CL-B<br>YTX15L-BS<br>YTX20HL-BS   |  |  |  |  |
| <b>5</b>  |          |      |     | YTX4L-BS<br>YTX9-BS<br>YTX16-BS<br>YB4L-A<br>YTX5L-BS<br>YT12A-BS<br>YB4L-B<br>YTZ7S<br>YTX12-BS<br>YB16C-B<br>YB16CL-B<br>YTX7A-BS<br>KMX14-BS<br>YTX7L-BS<br>YTX14-BS<br>YIX30L-BS   |  |  |  |  |
| <b>6</b>  |          |      |     | YB3L-A<br>YB7L-B<br>YB12A-A<br>YB16-B-CX<br>12N5-3B<br>12N7-4A<br>12N9-4B-1<br>6N6-3B<br>B39-B<br>YB3L-B<br>YB9A-A<br>YB12AL-A<br>YB16L-B<br>12N5-4B<br>12N7-4B<br>12N10-3A<br>6N6-3B-1<br>B54-B<br>YB5L-B<br>YB9-B<br>YB12A-B<br>YB16HL-A-CX<br>12N5.5-3B<br>12N7D-3B<br>12N10-3A-1<br>6N11A-1B<br>B38-6A<br>YB7-A<br>YB9L-B<br>YB14A-A<br>SYB16L-B<br>12N5.5A-3B<br>12N9-3A-1<br>12N12A-4A-1<br>6N11-2D<br>YB7B-B<br>YB10L-B<br>YB16-B<br>12N7-3B<br>12N9-3B<br>6N12A-2D |  |  |  |  |
| <b>7</b>  |          |      |     | HYB16A-AB<br>Y50-N18A-A<br>YB16B-A1**<br>Y50-N18L-A<br>YB18-A<br>Y50-N18L-A-CX<br>YB18L-A<br>SY50-N18L-AT  |  |  |  |  |
| <b>8</b>  |          |      |     | YB10A-A2<br>YB12B-B2<br>SYB14L-A2<br>12N10-3A-2<br>YB10L-A2<br>YB14-A2<br>YB14-B2<br>12N11-3A-1<br>YB10L-B2<br>YB14A-A2<br>YB14L-B2<br>12N14-3A<br>YB12AL-A2*<br>YB14L-A2  |  |  |  |  |
| <b>9</b>  |          |      |     | YHD-12H<br>12N9-3A   |  |  |  |  |
| <b>10</b> |          |      |     | 51814<br>51913<br>53030  |  |  |  |  |
| <b>11</b> |          |      |     | YT9B-BS<br>YT7B-BS<br>YTZ10S<br>YTR9-BS<br>YTZ12S<br>YT12B-BS<br>YTZ14S<br>YT14B-BS  |  |  |  |  |
| <b>12</b> |          |      |     | YTR4A-BS   |  |  |  |  |
| <b>13</b> |          |      |     | YT4B-BS  |  |  |  |  |

### BATTERY BOLT AND NUT SETS

| DESCRIPTION  | PART #  |      |   |
|--|---------|------|---|
| 12mm Stainless Steel Bolt & Nut Set                        | 920-232 | 2.95 | E |
| 20mm, 12 Stainless Steel Bolt, Washer & Brass Spacer Set   | 920-233 | 2.95 | E |
| 16mm Stainless Steel Nut & Washer Set                      | 920-234 | 2.95 | E |
| 12mm Stainless Steel Bolt & Nut Set                        | 920-235 | 1.95 | E |
| 20mm, 12 Stainless Steel Bolt, Washer and Brass Spacer Set | 920-236 | 1.95 | E |
| 11mm Stainless Steel Bolt & Nut Set                        | 920-237 | 4.95 | E |
| 22mm Stainless Steel Bolt & Nut Set                        | 920-239 | 1.95 | E |
| 14mm Stainless Steel Bolt & Nut Set                        | 920-240 | 2.95 | E |



- accessories
- towables
- body
- controls
- electrical
- driveline
- engine
- fuel & intake
- chemicals
- tie downs
- tools
- towing & loading

MARINE



## YUASA BATTERY CROSS REFERENCE CHART

| YUASA   | EXIDE    | DEKA   | DELCO    | INTERSTATE   | GS-ZTONG YEE | GS-JSB      | MOTO CROSS | NAPA     | SEARS | WAL-MART | YACHT      |
|---|----------|--------|----------|--------------|--------------|-------------|------------|----------|-------|----------|------------|
| <b>FACTORY SEALED / SEALED MAINTENANCE FREE</b> |          |        |          |              |              |             |            |          |       |          |            |
| YTR4A-BS  | -        | -      | -        | CYTR4A-BS    | GTR4A-5      | -           | M62R4A     | -        | -     | -        | -          |
| YT4B-BS   | -        | -      | -        | CYT4B-BS     | GT4B-5       | -           | M62T4B     | -        | -     | -        | -          |
| YTX4L-BS  | 4L-BS    | -      | GT4L-BS  | CYTX4L-BS    | GT4L-BS      | -           | M62X4B     | 740-1865 | 44015 | ES4LBS   | CT4L-BS    |
| YTX5L-BS  | 5L-BS    | -      | GTX5L-BS | CYTX5L-BS    | GTX5L-BS     | -           | M32X5B     | -        | 44022 | -        | -          |
| YTX7A-BS  | 7A-BS    | -      | -        | CYTX7A-BS    | GTX-7A-BS    | -           | M32X7A     | -        | 44023 | -        | CTX7A-BS   |
| YT7B-BS   | -        | -      | -        | CYT7B-BS     | GT7B-4       | -           | M62T7B     | -        | -     | -        | -          |
| YTX7L-BS  | 7L-BS    | -      | -        | CYTX7L-BS    | -            | GTX7L-BS    | M327BS     | -        | 44024 | -        | CTX7L-BS   |
| YTZ7S   | -        | -      | -        | FAYTZ7S      | GT6B-3       | -           | M727ZS     | -        | -     | -        | -          |
| YTX9-BS   | 9-BS     | ETX9   | GTX9-BS  | CYTX9-BS     | GTX9-BS      | -           | M329BS     | 740-1825 | 44025 | -        | CTX9-BS    |
| YT9B-BS   | -        | -      | -        | CYT9B-BS     | GT9B-4       | -           | M629B4     | -        | -     | -        | -          |
| YTZ10S  | -        | -      | -        | FAYTZ10S     | -            | -           | M7210A     | -        | -     | -        | -          |
| YTX12-BS  | 12-BS    | ETX12  | GTX12-BS | CYTX12-BS    | GTX12-BS     | -           | M3RH2S     | 740-1866 | 44016 | ES12BS   | CTX12-BS   |
| YT12B-BS  | -        | -      | -        | CYT12B-BS    | GT12B-4      | -           | M6212B     | -        | -     | -        | -          |
| YTZ12S  | -        | -      | -        | FAYTZ12S     | -            | -           | M7212A     | -        | -     | -        | -          |
| YTX14-BS  | 14-BS    | ETX14  | GTX14-BS | CYTX14-BS    | GTX14-BS     | -           | M3RH4S     | 740-1886 | 44017 | ES14BS   | CTX14-BS   |
| YTX14AH-BS                                      | -        | ETX15  | -        | CYTX14AH-BS  | -            | -           | M62H4A     | -        | 44004 | -        | -          |
| YTX14AHL-BS                                     | -        | ETX15L | -        | CYTX14AHL-BS | -            | -           | M62H4L     | -        | 44005 | -        | -          |
| YT14B-BS  | -        | -      | -        | CYT14B-BS    | GT14B-4      | -           | M624B4     | -        | -     | -        | -          |
| YTX14L-BS                                       | -        | -      | -        | CYTX14L-BS   | -            | -           | -          | -        | -     | -        | -          |
| YTZ14S  | -        | -      | -        | FAYTZ14S     | -            | -           | M72Z14     | -        | -     | -        | CTX20L-BS  |
| YTX15L-BS                                       | -        | -      | -        | CYTX15L-BS   | -            | -           | M6215L     | -        | 44162 | -        | -          |
| YTX16-BS  | -        | -      | -        | CYTX16-BS    | -            | -           | M32X6S     | -        | -     | -        | -          |
| YTX20-BS  | 16-BS    | ETX16  | TBA      | CYTX20-BS    | GT16-BS      | -           | M32RBS     | TBA      | 44028 | -        | -          |
| YTX20CH-BS                                      | -        | -      | -        | CYTX20CH-BS  | -            | -           | M6220C     | -        | -     | -        | -          |
| YTX20L-BS                                       | 16L-BS   | ETX16L | TBA      | CYTX20L-BS   | GT16L-BS     | -           | M320BS     | TBA      | 44027 | -        | -          |
| YTX20L-BS                                       | 20L-BS   | ETX20L | TBA      | CYTX20L-BS   | GTX20L-BS    | -           | M320BS     | TBA      | 44027 | -        | CTX20L-BS  |
| YTX24HL-BS                                      | 18L-BS   | ETX18L | TBA      | CYTX24HL-BS  | GTX18L-BS    | -           | M6250H     | TBA      | 44006 | -        | -          |
| YIX30L-BS                                       | -        | -      | -        | FAYIX30L     | -            | YGIX30      | M7230L     | -        | -     | -        | -          |
| <b>YUMICRON HIGH PERFORMANCE CONVENTIONAL</b>   |          |        |          |              |              |             |            |          |       |          |            |
| YB2.5L-C  | 2.5L-C   | -      | -        | YB2.5L-C     | CB2.5L-C     | GM2.5A-3C-3 | M325LC     | -        | 44035 | -        | CB2.5L-C   |
| YB2.5L-C-1                                      | 2.5L-C-1 | -      | -        | YB2.5L-C-1   | CB2.5L-C-1   | GM2.5A-3C-1 | M32LC1     | -        | 44036 | -        | CB2.5L-C-1 |
| YB3L-A  | 3L-A     | -      | -        | YB3L-A       | CB3L-A       | GM3-3A      | M323LA     | -        | 44037 | -        | CB3L-A     |
| YB3L-B  | 3L-B     | -      | -        | YB3L-B       | CB3L-B       | GM3-3B      | M223LB     | -        | 44038 | -        | CB3L-B     |
| YB4L-A  | 4L-A     | -      | -        | YB4L-A       | CB4L-A       | GM4A-3B     | M224LA     | -        | 44039 | -        | CB4L-A     |
| YB4L-B  | 4L-B     | -      | MC0414   | YB4L-B       | CB4L-B       | GM4-3B      | M324LB     | 740-1861 | 44014 | -        | CB4L-B     |
| YB5L-B  | 5L-B     | -      | -        | YB5L-B       | CB5L-B       | GM5Z-3B     | M325LB     | 740-1868 | 44353 | -        | CB5L-B     |
| YB7-A   | 7-A      | -      | -        | YB7-A        | CB7-A        | GM7Z-4A     | M227AY     | -        | 44040 | -        | CB7-A      |
| YB7C-A  | 7C-A     | -      | -        | YB7C-A       | -            | GM7CZ-3D    | M227CY     | M227CY   | 44041 | -        | CB7C-A     |
| YB7L-B  | 7L-B     | -      | -        | YB7L-B       | CB7L-B       | GM7-3B-1    | M2273Y     | -        | 44042 | -        | CB7L-B     |
| YB9A-A  | 9AA      | -      | CB9A-A   | YB9A-A       | CB9A-A       | GM9AZ-4A    | M329AY     | 740-1872 | 44043 | -        | CB9A-A     |
| YB9L-A2   | 9L-A2    | -      | -        | YB9L-A2      | CB9L-A2      | -           | M2292Y     | -        | 44044 | -        | CB9L-A2    |
| YB9-B   | 9-B      | -      | -        | YB9-B        | CB9-B        | GM9Z-4B     | M329BY     | 740-1858 | 44356 | -        | CB9-B      |

- accessories
- towables
- body
- controls
- electrical
- driveline
- engine
- fuel & intake
- chemicals
- tie downs
- tools
- towing & loading

MARINE



## YUASA BATTERY CROSS REFERENCE CHART CONTINUED

| YUASA   | EXIDE       | DEKA | DELCO     | INTERSTATE  | GS-ZTONG YEE | GS-JSB      | MOTO CROSS | NAPA     | SEARS | WAL-MART     | YACHT        |
|---|-------------|------|-----------|-------------|--------------|-------------|------------|----------|-------|--------------|--------------|
| <b>YUMICRON HIGH PERFORMANCE CONVENTIONAL</b> |             |      |           |             |              |             |            |          |       |              |              |
| YB9L-B  | 9LB         | -    | -         | YB9L-B      | CB9L-B       | GM9Z-3B     | M329LY     | 740-1837 | 44045 | -            | CB9L-B       |
| YB10A-A2                                      | 10A-A       | -    | -         | YB10A-A2    | CB10A-A      | -           | M321AY     | -        | 44046 | -            | CB10A-A      |
| YB10L-A2                                      | 10LA2       | -    | MC1114    | YB10L-A2    | CB10L-A2     | GM10Z-3A    | M3210Y     | 740-1857 | 44355 | ES10LA2      | CB10L-A2     |
| YB10L-B                                       | 10L-B       | -    | -         | YB10L-B     | CB10L-B      | GM10-3B     | M321LB     | 740-1831 | 44047 | -            | CB10L-B      |
| YB10L-B2                                      | 10L-B2      | -    | -         | YB10L-B2    | CB10L-B2     | -           | M221L2     | 740-1832 | 44048 | -            | -            |
| YB12A-A                                       | 12AA        | -    | MC1216    | YB12A-A     | CB12A-A      | GM12AZ-4A-1 | M3212Y     | 740-1854 | 44358 | ES12AA       | CB12A-A      |
| YB12AL-A                                      | 12AL-A      | -    | -         | YB12AL-A    | CB12AL-A     | GM12AZ-3A-1 | M3221Y     | 740-1873 | 44052 | -            | CB12AL-A     |
| YB12A-B                                       | 12A-B       | -    | -         | YB12A-B     | -            | -           | M222AB     | -        | 44053 | -            | CB12A-B      |
| YB12B-B2                                      | 12B-B2      | -    | -         | YB12B-B2    | CB12B-B2     | GM12B-4B    | M221B2     | -        | 44054 | -            | CB12B-B2     |
| YB12C-A                                       | 12C-A       | -    | -         | YB12C-A     | -            | GM12CZ-4A-2 | M222CA     | -        | 44055 | -            | CB12C-A      |
| YB14-A2                                       | 14-A2       | -    | -         | YB14-A2     | CB14-A2      | GM14Z-4A    | M3214H     | 740-1864 | 44363 | -            | CB14-A2      |
| YB14A-A1                                      | 14AA1       | -    | -         | YB14A-A1    | CB14A-A      | GM14AZ-4A   | M224A1     | 740-1826 | 44056 | -            | CB14A-A1     |
| YB14A-A2                                      | 14AA2       | -    | MC1418    | YB14A-A2    | CB14A-A2     | GM14AZ-4A-1 | M3214A     | 740-1860 | -     | ES14AA2      | CB14A-A2     |
| YB14L-A1                                      | 14L-A1      | -    | -         | YB14L-A1    | CB14L-A1     | GM14Z-3A-1  | M22141     | -        | 44057 | -            | CB14L-A1     |
| YMF14L-2 *                                    | 14L-2       | -    | -         | -           | -            | -           | -          | -        | -     | -            | -            |
| YB14L-A2                                      | 14L-A2      | -    | MC1406    | YB14L-A2    | CB14L-A2     | GM14Z-3A    | M3214Y     | 740-1851 | 44364 | ES14L-A2     | CB14L-A2     |
| YB14L-B2                                      | 14L-B2      | -    | -         | YB14L-B2    | CB14L-B2     | GM14Z-3B    | M2214B     | 740-1828 | 44059 | -            | CB14L-B2     |
| YB14-B2                                       | 14-B2       | -    | -         | YB14-B2     | CB14-B2      | -           | M224B2     | -        | 44060 | -            | CB14-B2      |
| SYB14L-A2                                     | 14LA2       | -    | -         | SYB14L-A2   | SCB14-LA2    | -           | M2214S     | -        | 44061 | -            | SCB14-LA2    |
| SYB14L-B2                                     | 14LB2       | -    | -         | SYB14L-B2   | SCB14-LB2    | -           | M22B4S     | -        | 44062 | -            | SCB14-LB2    |
| YB16AL-A2                                     | 16ALA2      | -    | CB16AL-A2 | YB16AL-A2   | CB16AL-A2    | GM16A-3A    | M32162     | 740-1877 | 44063 | -            | CB16AL-A2    |
| HYB16A-AB                                     | 16AA        | -    | -         | HYB16A-AB   | HCB16A-A     | GM16-T      | M32H6B     | 740-1867 | 44064 | -            | HCB16A-A     |
| YB16-B  | 16B         | -    | MC1912    | YB16-B      | CB16-B       | GM16Z-4BH   | M3216Y     | 740-1852 | 44366 | ES16B        | CB16-B       |
| YB16L-B                                       | 16LB        | -    | -         | YB16L-B     | CB16L-B      | GM16Z-3B    | M3216K     | 740-1827 | 44065 | -            | CB16L-B      |
| YB16-B-CX                                     | 16-B-LM     | -    | -         | YB16-B-LM   | GT16-BS      | -           | M3216C     | -        | 44029 | -            | CB16-B-LM    |
| YB16HL-A-CX                                   | 16HL-A-LM   | -    | -         | YB16HL-A-LM | GT16L-BS     | -           | M2H16C     | -        | -     | -            | CB16HL-A-LM  |
| YB16B-A                                       | 16B-A       | -    | -         | YB16B-A     | -            | GM16B-4A    | M2216B     | -        | 44066 | -            | CB16B-A      |
| YB16B-A1                                      | 16B-A1      | -    | -         | YB16B-A1    | -            | -           | M22161     | -        | 44067 | -            | CB16B-A1     |
| YB16C-B                                       | 16C-B       | -    | -         | YB16C-B     | -            | -           | M326CB     | -        | 44068 | -            | -            |
| YB16CL-B                                      | 16CLB       | -    | M1924     | YB16CL-B    | CB16CL-B     | GM16AZ-3B   | M3S6CL     | 740-1862 | 44001 | ES16CLB      | CB16CL-B     |
| SYB16L-B                                      | 16L-B       | -    | -         | SYB16L-B    | SCB16L-B     | -           | M22S6A     | -        | 44069 | -            | SCB16L-B     |
| YB18-A  | 18-A        | -    | -         | YB18-A      | CB18-A       | GM18A-4A    | M321Y      | 740-1874 | 44070 | -            | CB18-A       |
| YB18L-A                                       | 18LA        | -    | -         | YB18L-A     | CB18L-A      | GM18A-3A    | M3218L     | 740-1871 | 44071 | -            | CB18L-A      |
| Y50-N18A-A                                    | 50-N18A-A   | -    | -         | Y50-N18A-A  | -            | -           | M228AY     | -        | 44072 | -            | C50-N18A-A   |
| Y50-N18L-A                                    | 50N18LA2    | -    | MC2008    | Y50-N18L-A  | C50-N18L-A3  | GM18Z-3A(S) | M3218Y     | -        | -     | ES50N-N18L-A | SCB50-N18L-A |
| Y50-N18L-A3                                   | 50N18LA3 ** | -    | -         | Y50-N18L-A3 | C50-N18L-A3  | -           | M328A3     | 740-1855 | 44359 | -            | C50-N18L-A3  |
| Y60-N24-A                                     | 60-N24-A    | -    | -         | Y60-N24-A   | C60-N24L-A   | -           | M2224A     | -        | 44074 | -            | C60-N24-A    |
| Y60-N24AL-B                                   | 60-N24AL-B  | -    | -         | Y60-N24AL-B | -            | -           | M2224B     | 740-1880 | 44075 | -            | C60-N24AL-B  |

\* Superseded by YTX14AHL-BS

\*\* GNB's 50N18LA2 replaces 50N18LA3

- accessories
- towables
- body
- controls
- electrical**
- driveline
- engine
- fuel & intake
- chemicals
- tie downs
- tools
- towing & loading

# MARINE

## PWC BATTERY APPLICATION

| CC                       | APPLICATION                                  | YEAR  | MAINTENANCE FREE | HIGH PERFORMANCE MAINTENANCE FREE | MAINTENANCE YUMICRON | CONVENTIONAL |
|--------------------------|--|-------|------------------|-----------------------------------|----------------------|--------------|
| <b>AQA-JET CO.</b>       |  |       |                  |                                   |                      |              |
| 430                      | Aqua-Jet SX1                                 | 91    | -                | -                                 | YB16-B               | -            |
| 432                      | Aqua-Jet Sx1                                 | 89-90 | -                | -                                 | YB16-B               | -            |
| <b>ARCTIC CAT</b>        |  |       |                  |                                   |                      |              |
| 640                      | Tiger Shark                                  | 97-99 | YTX14AHL-BS*     | -                                 | YB14L-A2             | -            |
| 640                      | Tiger Shark                                  | 93-96 | -                | -                                 | YB16C-B              | -            |
| 770                      | Tiger Shark                                  | 97-99 | YTX14AHL-BS*     | -                                 | YB14L-A2             | -            |
| <b>BRP – SEA-DOO</b>     |  |       |                  |                                   |                      |              |
| 1500                     | GTI, GTR, GTS, GTX, RXT, RXP, WAKE           | 16    | GYZ20HL          | YTX20L                            |                      |              |
| 1500                     | GTI, GTX, RXP, RXT, WAKE                     | -15   | -                | -                                 | YB30CL-B             | -            |
| 1500                     | GTX 4-Tec, RXP                               | 03-07 | -                | -                                 | YB30CL-B             | -            |
| 1500                     | All Models                                   | 88-93 | YTX20HL-BS*      | YTX20L-BS*                        | YB16L-B              | -            |
| 1500                     | All Other Models                             | 94-07 | YTX20HL-BS-PW*   | -                                 | YB16CL-B             | -            |
| 900                      | SPARK  | 14-16 | GYZ20HL          | YTX20L                            |                      |              |
| 780                      | 3D   | -07   | YTX20HL-BS-PW*   | -                                 | YB16CL-B             | -            |
| <b>HONDA</b>             |  |       |                  |                                   |                      |              |
| 1235                     | AquaTrax F/R-12, F/R-12X                     | 02-09 | YTX20HL-BS*      | YTX20L-BS                         | -                    | -            |
| 1470                     | AquaTrax F-15, F-15X                         | 03-13 | YTX20HL-BS*      | YTX20L-BS                         | -                    | -            |
| <b>KAWASAKI</b>          |  |       |                  |                                   |                      |              |
| 300                      | JS300 TS, SX                                 | 86-91 | YTX20HL-BS-PW*   | -                                 | YB16CL-B             | -            |
| 400                      | JS400  | 76    | YTX20HL-BS*      | YTX20L-BS*                        | YB16L-B              | -            |
| 440                      | JS440  | 87-92 | YTX20HL-BS-PW*   | -                                 | YB16CL-B             | -            |
| 440                      | JS440  | 77-86 | YTX20HL-BS*      | YTX20L-BS*                        | YB16L-B              | -            |
| 550                      | JS550  | 82-85 | YTX20HL-BS*      | YTX20L-BS*                        | YB16L-B              | -            |
| 550                      | JS550, SX                                    | 86-95 | YTX20HL-BS-PW*   | -                                 | YB16CL-B             | -            |
| 650                      | JF650 TS                                     | 89-96 | YTX20HL-BS-PW*   | -                                 | YB16CL-B             | -            |
| 650                      | JF650 X2                                     | 86-95 | YTX20HL-BS-PW*   | -                                 | YB16CL-B             | -            |
| 650                      | JL650 SC                                     | 91-95 | YTX20HL-BS-PW*   | -                                 | YB16CL-B             | -            |
| 650                      | JS650 SX                                     | 87-95 | YTX20HL-BS-PW*   | -                                 | YB16CL-B             | -            |
| 750                      | JH750 B1-b3                                  | 93-95 | YTX20HL-BS-PW*   | -                                 | YB16CL-B             | -            |
| 750                      | JH750 E1,F2,G1,G2                            | 95-99 | YTX20HL-BS*      | YTX20L-BS                         | -                    | -            |
| 750                      | JH750 SS, ST, Xi, XiR                        | 92-99 | YTX20HL-BS-PW*   | -                                 | YB16CL-B             | -            |
| 750                      | JH750 ST, Zxi                                | 95-97 | YTX20HL-BS*      | YTX20L-BS                         | -                    | -            |
| 750                      | JH750 SX,ZX                                  | 92-95 | YTX20HL-BS-PW*   | -                                 | YB16CL-B             | -            |
| 750                      | JS750 SX, ZX                                 | 92-95 | YTX20HL-BS-PW*   | -                                 | YB16CL-B             | -            |
| 750                      | JS750 SXi, SXi Pro                           | 95-02 | YTX20HL-BS*      | YTX20L-BS                         | -                    | -            |
| 750                      | JT750 STS, STX                               | 96-98 | YTX20HL-BS*      | YTX20L-BS                         | -                    | -            |
| 800                      | JS800 SX-R                                   | 03-13 | YTX20HL-BS*      | YTX20L-BS                         | -                    | -            |
| 900                      | JH900 ZXi                                    | 95-97 | YTX20HL-BS*      | YTX20L-BS                         | -                    | -            |
| 900                      | JT900 STS, STX                               | 97-05 | YTX20HL-BS*      | YTX20L-BS                         | -                    | -            |
| 1100                     | JH1100 ZXi                                   | 96-03 | YTX20HL-BS*      | YTX20L-BS                         | -                    | -            |
| 1100                     | JH1100-B Ultra 130                           | 01-04 | YTX20HL-BS*      | YTX20L-BS                         | -                    | -            |
| 1100                     | JT1100 STX                                   | 97-03 | YTX20HL-BS*      | YTX20L-BS                         | -                    | -            |
| 1200                     | JH1200-A, B Ultra 150                        | 99-05 | YTX20HL-BS*      | YTX20L-BS                         | -                    | -            |
| 1200                     | JT1200-A-B, C, STX-R, STX-12F                | 02-07 | YTX20HL-BS*      | YTX20L-BS                         | -                    | -            |
| 1500                     | JT1500-A, STX, STX-15F                       | 04-13 | YTX20HL-BS*      | YTX20L-BS                         | -                    | -            |
| 1500                     | JT1500B, C, 250X, Ultra LX, 260(L)X, 300(L)X | 07-16 | YTX20HL-BS*      | YTX20L-BS                         | -                    | -            |
| <b>POLARIS</b>           |  |       |                  |                                   |                      |              |
| All                      | All Models                                   | All   | YTX20HL-BS-PW*   | -                                 | YB16CL-B             | -            |
| <b>S.O.S. MARINE MFG</b> |  |       |                  |                                   |                      |              |
| All                      | All Models                                   | All   | YTX20H-BS*       | YTX20-BS*                         | YB16-B-CX*           | YB16-B       |
| <b>ULTRANAUTICS</b>      |  |       |                  |                                   |                      |              |
| 800                      | All Models                                   | 87-92 | -                | -                                 | 53030                | -            |
| 800                      | Wet Bike                                     | 85-86 | -                | -                                 | -                    | YHD-12H      |
| 1250                     | Jet Star1250 (Boat)                          | 88-90 | -                | -                                 | 53030                | -            |
| 1250                     | Jet Star1260 (Boat)                          | 91    | -                | -                                 | 53030                | -            |

accessories  
towables  
body  
controls  
electrical  
driveline  
engine  
fuel & intake  
chemicals  
tie downs  
tools  
towing & loading

MARINE



## PWC BATTERY APPLICATION CONTINUED

| CC                           | APPLICATION            | YEAR  | MAINTENANCE FREE | HIGH PERFORMANCE MAINTENANCE FREE | MAINTENANCE YUMICRON | CONVENTIONAL |
|------------------------------|------------------------|-------|------------------|-----------------------------------|----------------------|--------------|
| <b>WET JET INTERNATIONAL</b> |                        |       |                  |                                   |                      |              |
| All                          | All Models             | All   | YTX20H-BS*       | YTX20-BS*                         | YB16-B-CX*           | YB16-B       |
| <b>YAMAHA</b>                |                        |       |                  |                                   |                      |              |
| All                          | All Wave Runner Models | 87-08 | YTX20HL-BS-PW*   | -                                 | YB16CL-B             | -            |
| 700                          | Superjet               | 09-16 | YTX20HL-BS-PW*   | -                                 | YB16CL-B             | -            |
| 1100                         | VX, V1                 | 09-16 | YTX20HL-BS-PW*   | -                                 | YB16CL-B             | -            |
| 1800                         | FX, FZR, FZS, VXS, VXR | 09-16 | YTX20HL-BS-PW*   | -                                 | YB16CL-B             | -            |

\* See battery cross reference chart.

### **YUASA MB-2040 BATTERY CHARGER**

- High Output charging current (4 amps)
- High Voltage capable (20 volts) – designed to improve recovery of sulfated batteries
- Switchable Mode operation
- “Fast Mode” – for quick vehicle set-up
- “Normal Mode” – ideal for smaller batteries, initial activation, and deeply discharged batteries
- Commercial Grade – perfect for Dealer / Shop use
- Suitable for all battery types – Conventional, as well as MF (AGM), including YTZ
- Automatic Shut-Off
- Reverse Polarity Protection / Spark-free Operation (UL / CUL) approved)
- Durable construction for longer life
- 3 year limited warranty



| PART #  | DESCRIPTION     |        |   |
|---------|-----------------|--------|---|
| 920-227 | Battery Charger | 254.95 | E |

### **YUASA BATTERY CHARGER/MAINTAINER**

- Fully automatic three level charge cycle for effective charging
- Reaches 14.4 volts peak, then automatically switches to float
- Designed to prevent overcharging
- AC power LED indicator
- Charging and float mode LED display
- Reverse polarity protection
- Spark-free operation
- Durable construction for longer life
- Battery accessory leads and fused ring connectors included
- 12 ft. output cord
- 3 year limited warranty



| PART #  | DESCRIPTION        |       |   |
|---------|--------------------|-------|---|
| 258008  | Charger/Maintainer | 37.95 | E |
| 920-230 | Ring Connector     | 6.95  | E |

### **YUASA BATTERY TESTER**

- Developed exclusively for the Powersports industry
- Determines accurate battery status in seconds
- Single load, dynamic resistance technology minimizes battery drain during test
- Tests both charged and discharged batteries accurately
- 1 year limited warranty



| PART #  | DESCRIPTION    |        |   |
|---------|----------------|--------|---|
| 920-229 | Battery Tester | 239.95 | E |

### **YUASA JUMPER CABLES**

- Easy to use, easy to store
- Convenient storage bag
- Heavy duty, 8 ft., 8-gauge cables won't stiffen or freeze
- Tangle resistant, encased rubber grips for safer use



| PART #  | DESCRIPTION   |       |   |
|---------|---------------|-------|---|
| 920-228 | Jumper Cables | 25.95 | E |

accessories

towables

body

controls

electrical

driveline

engine

fuel & intake

chemicals

tie downs

tools

towing & loading

MARINE



## Chargers & Accessories

Since the family started this company in 1965, Deltran Battery Tender® has taken great pride in designing, manufacturing, and distributing technologically advanced products that meet the ever changing needs of our worldwide customers! Our strategic initiatives have continued to focus on innovation and customer satisfaction.

Here at Deltran, performance isn't just a business, it's a way of life. Long after the final sale, our commitment to service lives on. We are constantly striving to improve every element of our business; from the products themselves to marketing and distribution. As the world advances, we remain state-of-the art with innovative designs and technologies.

So why use a Battery Tender® Charger over a conventional charger? Battery Tender®'s BTP Microprocessor Technology and quick-connect convenience automatically maintains the batteries in all your vehicles. They are ready to go when you are! You just set it and forget it, saving you hundreds of dollars in replacement batteries!

Battery Tender® assures the highest quality, fast-charging convenience and performance. That's why we are the top choice of collectors, dealers, and fleet owners!

### BATTERY TENDER® PLUS

The Battery Tender® Plus is a 1.25 amp battery charger designed to fully charge a battery and maintain it at proper storage voltage without the damaging effects caused by trickle chargers. Included is a quick connect ring terminal harness for hard to reach areas and alligator clips for an alternate connection.

- Temperature compensated to ensure optimum charge voltage according to ambient temperature.
- Automatically switches from full charge to float charging mode.
- Battery Tender® at 1.25 amps will charge as fast or faster than any 3 amp charger available.
- Reverse Polarity Protection to ensure user safety. Red & Green Lights Alternately Flash in this condition.
- Complete 4-step charging program (Initialization, Bulk Charge, Absorption Mode, Float Mode).
- 10 year Warranty!

| PART # | DESCRIPTION |       |   |
|--------|-------------|-------|---|
| DL9012 | 12 Volts    | 69.95 | B |





## BATTERY TENDER® PLUS GEL 12V @ 1.25A

The Battery Tender® Plus GEL is a 1.25 amp battery charger designed to fully charge a battery and maintain it at proper storage voltage without the damaging effects caused by trickle chargers. Included is a quick connect harness for hard to reach areas.

- Temperature compensated to ensure optimum charge voltage according to ambient temperature.
- Automatically switches from full charge to float charging mode.
- Battery Tender® at 1.25 amps will charge as fast or faster than any 3 amp charger available.
- Reverse Polarity Protection to ensure user safety. Red & Green Lights Alternately Flash in this condition.
- Complete 4-step charging program (Initialization, Bulk Charge, Absorption Mode, Float Mode).
- Optimized for GEL Batteries
- 10 year Warranty!



| PART # | DESCRIPTION             |       |   |
|--------|-------------------------|-------|---|
| DL0101 | Battery Tender Plus Gel | 69.95 | B |

## WATERPROOF 800 INTERNATIONAL

This compact 800 mA battery charger has all the charge characteristics of its cousin the Battery Tender® Junior. It incorporates highly efficient surface mount technology electronic components. The interior is completely encapsulated, protected from shock, vibration, and moisture by an electrically insulating, thermally conductive, flame retardant, synthetic epoxy resin compound. It's tough, affordable, and a strong, innovative battery charging solution. This charger is no larger than a standard computer mouse yet packs 800 millamps of pure constant current charging power. Coupled with a brain (IC chip), the charger will constantly monitor, charge, and then maintain your battery --- even while totally submersed under water! Perfect for all outdoor types of ATV's, watercraft, motorcycles, boats, or anywhere water is a threat. International universal input voltage works anywhere in the world 100-240 AC Volts 50/60 Hz.

- "Supersmart" Technology
- Spark Proof
- Short Circuit Protected
- Reverse Polarity Protected
- Waterproof
- Weighs only 1 Pound
- 3 Year Warranty



| PART # | DESCRIPTION                   |       |   |
|--------|-------------------------------|-------|---|
| DL0150 | Waterproof 800 Battery Tender | 52.95 | G |

## WATERPROOF POWER TENDER PLUS 12V @ 5A

WATERPROOF, Shock & Vibration Resistant, Lightweight (LESS THAN 4 POUNDS), compact charger designed for either portable operation or permanent mounting. Charges and maintains both flooded and sealed, maintenance free, AGM, lead acid batteries. Float / Maintenance function maintains batteries at proper storage voltage without the damaging effects caused by trickled chargers. The Power Tender PLUS is easy to use, it's rugged, its compact, it's packed with power, and it's backed by the reputation of the undisputed battery charger industry leader, DELTRAN.

- WATERPROOF !!
- Shock & Vibration Resistant
- Lightweight - LESS THAN 4 POUNDS!
- Microprocessor Controlled, BTP Technology
- Charges both flooded & sealed maintenance free lead acid batteries.
- Charges any size (capacity) lead acid battery.
- Reverse Polarity Protection (VIA EXTERNAL IN-LINE FUSE).
- Complete FOUR-Step Charging Program (Initialization, Bulk, Absorption, & Float / Maintenance).
- 2 Year Warranty



| PART # | DESCRIPTION                  |        |   |
|--------|------------------------------|--------|---|
| DL0105 | Waterproof Power Tender Plus | 125.95 | B |

accessories

towables

body

controls

electrical

driveline

engine

fuel &amp; intake

chemicals

tie downs

tools

towing &amp; loading

MARINE

- accessories
- towables
- body
- controls
- electrical
- driveline
- engine
- fuel & intake
- chemicals
- tie downs
- tools
- towing & loading

MARINE

## 2 BANK INTERNATIONAL CHARGER

The 2 Bank Battery Tender Charging Station is two encased 1.25 amp battery chargers designed to fully charge a battery and maintain it at proper storage voltage without the damaging effects caused by trickle chargers. This charger will operate anywhere in the world!

- 2 independent charging stations.
- 12 volts @ 1.25 amps per station
- Extremely lightweight! Less than 3 lbs!
- Operates anywhere in the world! 100-240 VAC 50/60 Hz.
- Microprocessor controlled constant current charging!
- Reverse Polarity Protected.
- Spark Proof
- Perfect for all AGM (absorbed glass mat), sealed maintenance free and flooded batteries
- Complies with US and international safety standards (UL/CE).
- 2 year warranty!



| PART # | DESCRIPTION             |
|--------|-------------------------|
| DL0165 | 2 Bank Charger 129.95 B |

## 4 BANK INTERNATIONAL CHARGER

The 4 Bank Battery Tender Charging Station is four encased 1.25 amp battery chargers designed to fully charge a battery and maintain it at proper storage voltage without the damaging effects caused by trickle chargers. This charger will operate anywhere in the world!

- 4 independent charging stations
- 12 volts @ 1.25 amps per station.
- Extremely lightweight! Less than 3 lbs!
- Operates anywhere in the world! 100-240 VAC 50/60 Hz.
- 25 ft leads available (NOT INCLUDED)
- Microprocessor controlled constant current charging!
- Reverse Polarity Protected
- Spark Proof
- Perfect for all AGM (absorbed glass mat), sealed maintenance free and flooded batteries
- Complies with US and international safety standards (UL/CE).
- 2 year warranty!



| PART # | DESCRIPTION             |
|--------|-------------------------|
| DL0148 | 4 Bank Charger 255.95 B |

## 5 BANK CHARGER 12V @ 2A

Deltran's advanced SuperSmart Battery Tender® Battery Management System is light years ahead of any standard battery charger.

- It's the first fully automatic, constant-current battery charger designed to charge and/ or maintain up to 5 12-volt batteries simultaneously @ 2 amps. (Note: Please allow 2-4 weeks for shipment of this unit).
- Safe, No Spark Charging!
- To avoid dangerous dead-short sparking, microchip circuitry will not activate output voltage until clips are correctly connected to battery.
- Simultaneously charges and/ or maintains up to 5 batteries.
- Maintains batteries at full charge.
- 2 amps per output charging current.
- Six foot lead with clamps included.
- 3 year warranty.



| PART # | DESCRIPTION             |
|--------|-------------------------|
| DL0103 | 5 Bank Charger 644.95 B |

## 10 BANK CHARGER 12V @ 2A

Safe, No Spark Charging! Deltran's advanced SuperSmart Battery Tender® Battery Management System is light years ahead of any standard battery charger.

It's the first fully automatic, constant-current battery charger designed to charge and/ or maintain up to 10 12-volt batteries simultaneously @ 2 amps. (Note: Please allow 2-4 weeks for shipment of this unit).

- To avoid dangerous dead-short sparking, microchip circuitry will not activate output voltage until clips are correctly connected to battery.
- Simultaneously charges and/ or maintains up to 10 batteries.
- Maintains batteries at full charge.
- 2 amps per output charging current.
- Six foot lead with clamps included.
- 3 year warranty.



| PART # | DESCRIPTION              |
|--------|--------------------------|
| DL0104 | 10 Bank Charger 835.95 B |

## BATTERY TENDER® JUNIOR 12V @ 0.75A

The Battery Tender® Junior is much more than a trickle charger. It has a brain. It's lightweight, compact, and fully automatic; very easy to use, especially in small spaces. It will keep your battery fully charged so that it is ready to go when you are!

- Perfect for all lead-acid, flooded or sealed maintenance free batteries (AGM and gel cell).
- Complete 4-step charging program (Initialization, Bulk Charge, Absorption Mode, Float Mode).
- Automatically switches to float / maintenance voltage after fully charging the battery.
- If the battery voltage drops too far under load, full charger output power resumes.
- Solid state two color LED indicates stage of charger.
- Spark proof.
- Reverse polarity protected.
- 12' output cord.
- 5 year warranty



| PART # | DESCRIPTION           |       |   |
|--------|-----------------------|-------|---|
| DL0123 | Battery Tender Junior | 39.95 | L |

## BATTERY TENDER® JUNIOR HIGH EFFICIENCY

The Battery Tender® Junior High Efficiency is much more than a trickle charger. It has a brain. It's lightweight, compact, and fully automatic; very easy to use, especially in small spaces. It will keep your battery fully charged so that it is ready to go when you are! This unit replaces the 021-0123 in the California market.

Input: 120VAC, 60Hz

Output: 12 Volts DC @ 750mA

Perfect for all lead-acid, flooded or sealed maintenance free batteries (AGM and gel cell).

- Complete 4-step charging program (Initialization, Bulk Charge, Absorption Mode, Float Mode).
- Automatically switches to float / maintenance voltage after fully charging the battery.
- Solid state two color LED indicates stage of charger.
- Spark proof.
- Reverse polarity protected.
- 12' output cord.
- Safety timer: 80 hours
- 5 year warranty
- Listed in California Appliance Efficiency Database
- Agency Approvals: UL/ CSA/ BC



| PART # | DESCRIPTION                           |       |   |
|--------|---------------------------------------|-------|---|
| DL0102 | Battery Tender Junior High Efficiency | 39.95 | B |

## BATTERY TENDER® CASE

This zippered carrying case was designed for the Battery Tender® International and is also suitable for the Battery Tender® Plus & Junior units. It's a convenient way to protect your Battery Tender® and accessories from dirt or loss.



| PART # | DESCRIPTION      |      |   |
|--------|------------------|------|---|
| 462000 | Small, 4" x 6"   | 5.95 | G |
| DL0113 | Medium, 6" x 8"  | 6.95 | B |
| DL0114 | Large, 10" x 12" | 8.95 | B |

## BATTERY TENDER® DUAL PORT USB CHARGER

Car charger for: iPad, tablets, and all cell phones. Use your existing USB cord to charge any electronic device in the car. Can charge 2 devices at the same time.

- Dual port USB car charger
- INPUT: 12-24V
- OUTPUT: 2.1A for iPad / Tablets, and 1A for all cell phones
- Smart fuse for surge protection
- Use existing USB charge / sync cable for charging (not included)



| PART # | DESCRIPTION           |       |   |
|--------|-----------------------|-------|---|
| DL0122 | Dual Port USB Charger | 14.95 | B |

## BATTERY TERMINAL CLEANER & ACID NEUTRALIZER

Provides a one-step solution to battery terminal corrosion removal and acid neutralization. Delivers a powerful, heavy-duty foam that clings to battery surfaces, provides extended contact time and neutralizes acid quickly. Helps eliminate power leaks and aids in restoring full starting power. Features a low odor, non-flammable, water-soluble formula. Contains a unique color indicator that turns red in the presence of acid, then changes back to yellow when the acid is neutralized. Leaves behind a residual film that provides short term corrosion resistance.



| PART # | DESCRIPTION     |      |   |
|--------|-----------------|------|---|
| DL0121 | Battery Cleaner | 7.95 | B |

- accessories
- towables
- body
- controls
- electrical
- driveline
- engine
- fuel & intake
- chemicals
- tie downs
- tools
- towing & loading

# MARINE

- accessories
- towables
- body
- controls
- electrical**
- driveline
- engine
- fuel & intake
- chemicals
- tie downs
- tools
- towing & loading

## RING TERMINAL HARNESSSES

Ring Terminal Harness Accessory for use with multiple batteries.

- Quick Disconnect
- For 12 volt models only
- Contains a 7.5 amp fuse
- 2 ft. long



| PART # | DESCRIPTION                       |      |   |
|--------|-----------------------------------|------|---|
| DL0693 | Ring Terminal, QDC - Black, Fused | 7.60 | G |
| DL0107 | Ring Terminal, QDC - White, Fused | 7.50 | B |

## ALLIGATOR CLIPS

Alligator Clip Accessory for use with multiple batteries.

- Quick Disconnect
- For 12 volt models only
- 2 ft. long

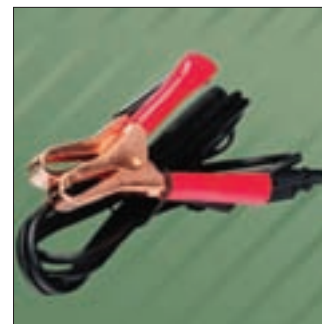

| PART # | DESCRIPTION                               |      |   |
|--------|---|------|---|
| DL0108 | Alligator Clips, Quick Disconnect - White | 7.50 | B |
| DL0694 | Alligator Clips, Quick Disconnect - Black | 7.60 | G |

## CIGARETTE LIGHTER ADAPTOR

- Black
- Quick Disconnect
- 12V models only



| PART # | DESCRIPTION                                 |      |   |
|--------|---|------|---|
| DL0110 | Cigarette Adapter, Quick Disconnect - Black | 7.50 | B |

## FEMALE CIGARETTE ADAPTER

Female Cigarette Adapter with quick disconnect adapter.



| PART # | DESCRIPTION                           |      |   |
|--------|---------------------------------------|------|---|
| DL0111 | Female Cigarette Adapter, QDC - Black | 9.95 | B |

## 25 FT. EXTENSION LEAD

25 ft. Extension Lead for use to extend the length of the charger's reach from input to battery. **(NOT COMPATIBLE WITH 6V BATTERY TENDER® PLUS or any other Battery Tender® product with white quick-disconnect plugs.)**



| PART # | DESCRIPTION                            |       |   |
|--------|--|-------|---|
| DL0115 | 25 ft Quick Disconnect Extension Cable | 14.25 | B |
| DL0116 | 25 ft QDC Extension Cable (4-Pack)     | 52.00 | B |

## 12.5 FT. EXTENSION LEAD

12.5 ft. Extension Lead for use to extend the length of the charger's reach from input to battery. **(NOT COMPATIBLE WITH 6V BATTERY TENDER® PLUS or any other Battery Tender® product with white quick-disconnect plugs.)**



| PART # | DESCRIPTION                              |       |   |
|--------|--|-------|---|
| DL0117 | 15.5 ft Quick Disconnect Extension Cable | 9.95  | B |
| DL0118 | 15.5 ft QDC Extension Cable (4-Pack)     | 33.25 | B |

## DIGITAL VOLTAGE INDICATOR WITH LCD DISPLAY

Designed for use on 12v Flooded, AGM and Gel batteries. Display voltage range is 3 to 16.



| PART # | DESCRIPTION                    |       |   |
|--------|--------------------------------|-------|---|
| DL0119 | Quick Disconnect w/LCD Display | 16.95 | B |



## MULTI-PURPOSE BATTERY CHARGERS

The NOCO Genius Multi-Purpose Battery Chargers are designed with versatility in mind. All of the chargers in the multi-purpose line are packed with features that are designed to diagnose, recover, charge and maintain a wide range of batteries, in a wide range of applications. The quick connect system allows users to move one charger between multiple applications with ease. Eyelet Terminal Connectors can be left installed on some vehicles, while utilizing the Battery Clamp Connectors or 12V Plug Connectors to charge and maintain other applications. Overall, the NOCO Genius multi-purpose battery chargers are perfect for users looking for flexibility and who want the ability to quickly switch between applications.

### G750 .75A (750mA) 6V & 12V

WICKED SMALL, WICKED SMART!

The G750 is a smart, 5 Step, fully automatic switch-mode battery charger and maintainer. The G750 is best for small battery applications from 1.2-30Ah, such as charging your Motorcycle, ATV, Jet Ski or Snowmobile. In addition to charging, the G750 can effectively maintain any 6V or 12V batteries in larger applications, such as Cars, RVs, Boats and Trucks.



| PART # | MFG # |       |   |
|--------|-------|-------|---|
| 650209 | G750  | 37.95 | G |



### G1100 1.1A (1100mA) 6V & 12V

WICKED CAPABILITY, WICKED SMART!

The G1100 is a smart, 7 Step, fully automatic switch-mode battery charger and maintainer. The G1100 is best for small battery applications from 2.2-40Ah, such as charging your Motorcycle, ATV, Jet Ski or Snowmobile. In addition to charging, the G1100 can effectively maintain any 6V or 12V batteries in larger applications, such as Cars, RVs, Boats and Trucks.

| PART # | MFG # |       |   |
|--------|-------|-------|---|
| 650210 | G1100 | 53.95 | E |

### G3500 3.5A (3500mA) 6V & 12V

WICKED VERSATILITY, WICKED SMART!

The G3500 is a smart, 8 Step, fully automatic switch-mode battery charger and maintainer. The G3500 restores batteries to their original capacity, recovers slightly sulfated batteries, charges batteries in cold climates, rescues drained batteries and provides maintenance charging to increase battery life. A versatile battery charger that provides charging modes for both large and small batteries from 1.2-120Ah, such as Cars, RVs, Boats and Trucks, as well as for Motorcycles, ATVs, Jet Skis or Snowmobiles.



| PART # | MFG # |       |   |
|--------|-------|-------|---|
| 650211 | G3500 | 74.95 | E |



### G7200 7.2A (7200mA) 12V & 24V

WICKED FEATURES, WICKED SMART!

The G7200 is a smart, 12 Step, fully automatic switch-mode battery charger and maintainer. The G7200 restores batteries to their original capacity, recovers slightly sulfated batteries, charges batteries in cold climates, rescues drained batteries, and provides maintenance charging to increase battery life. A powerful battery charger with specialized charging modes for recovering severely drained batteries that will not accept a normal charge. Suitable for most 12V and 24V battery capacities from 14-230Ah, such as Motorcycles, ATVs, UTVs, Snowmobiles, Jet Skis, Cars, RVs, Boats and Trucks.

| PART # | MFG # |        |   |
|--------|-------|--------|---|
| 650212 | G7200 | 118.95 | B |

- accessories
- towables
- body
- controls
- electrical**
- driveline
- engine
- fuel & intake
- chemicals
- tie downs
- tools
- towing & loading

# MARINE

# ELECTRICAL

**G4**  
**4.4A (1.1A/BANK)**  
**6V & 12V**

| PART # | MFG #       |
|--------|-------------|
| 650216 | G4 238.95 E |



Automatically Diagnoses, Recovers, Charges & Maintains Your Batteries!  
**NOW THAT'S SMART...WICKED SMART!**

The G4 is a smart, 7 Step, fully automatic switch-mode battery charger and maintainer with 4 independent battery banks. The G4 allows different battery sizes, voltages (6V or 12V), and chemistries to be charged at the same time safely and efficiently. The G4 is best for charging multiple small battery applications from 2.2-40Ah, such as Motorcycles, ATVs, Jet Skis or Snowmobiles. In addition to charging, the G4 can effectively maintain any 6V or 12V batteries in larger applications, such as Cars, RVs, Boats and Trucks. With 4 independent battery banks, the G4 is the best way to keep all of your vehicles maintained at the same time.

## Wicked Smart Features:

**INTEGRATED AC CORD MANAGER**  
 Route the AC cord out of any side of the charger and store excess cord under the charger for convenience

**CHARGE MULTIPLE BATTERIES**  
 Charge multiple batteries independently at the same time, including both 6V & 12V as well as multiple chemistries

**ABNORMALITY PROTECTION**  
 Automatically shuts "off" if charger remains in Bulk charge mode for an extended period of time

**6V 12V COMPATIBILITY**  
 Charges 6V & 12V batteries

**FULLY INTERACTIVE**  
 Automatically adjusts itself to changing current needs

**DESIGNED FOR SAFETY**  
 Reverse polarity, short circuit, open circuit, spark proof, overheat, overcurrent & overcharge

**REMOVABLE CHARGE CABLES**  
 Add and remove charge cables for clean and professional installations

**EXTENDABLE CONNECTORS**  
 Plug-n-play connectors for easy accessory changes

**MULTIPLE BATTERY CHEMISTRY**  
 Safely charges Wet, Gel, MF & AGM batteries

**RAPID CHARGING TECHNOLOGY**  
 Charges batteries 2X faster than traditional linear battery chargers

**RECOVERY MODE**  
 Recovers deeply discharged & sulphated batteries with pulse charging

**HF/HE SWITCH MODE DESIGN**  
 High-frequency, high-efficiency for a lightweight, compact charger

**RCT**  
 Charges batteries 2X faster than traditional linear battery chargers

**RECOVERY MODE**  
 Recovers deeply discharged & sulphated batteries with pulse charging

**AUTO-MEMORY**  
 Returns to last selected mode when restarted

**VARIABLE INPUT COMPENSATED**  
 100% full charge even with varying A/C input voltages

**COLD/AGM MODE**  
 Optimized charge mode for cold weather or AGM batteries

## SOLAR BATTERY CHARGERS + MAINTAINERS



**BRING LIFE TO YOUR BATTERIES WITH THE POWER OF THE SUN**

Solar panels are comprised of photovoltaic cells ("photo" meaning light, "voltaic" meaning electricity) that convert sunlight into power.

The sun gives off enormous amounts of energy in the form of heat and light, which is captured by the cells. In turn, the power from the light essentially loosens electrons from the cells in order to create a flow of energy. This energy is then directed to either a storage unit (such as a battery) or through a regulator (such as our FLEX line) directly to a device. This allows you to generate energy wherever you go, as long as the sun is shining.



**2.5 Watt Solar Battery Charger**

| PART #         |
|----------------|
| 650281 32.95 B |



**5 Watt Solar Battery Charger**

| PART #         |
|----------------|
| 650282 63.95 B |

Keeps 12-volt lead-acid batteries fully charged and maintained through solar power and provides up to 180mA (for the 2.5 Watt) / 410mA (for the 5 Watt) charging current to counteract parasitic drain of most vehicles, such as cars, boats, trucks, motorcycles, ATVs, RVs, lawn mowers, and more. Safely charges wet cell, gel cell, AGM, enhanced flooded battery or any maintenance-free battery. Built-in safety protection for short-circuit, open-circuit, and over-current. Its ultra-low profile design makes it simple and easy to install, and completely weatherproof for outdoor use (rated at IP65). Integrated LED indicator illuminates when generating power. Thin film technology for performance in low-light, cloudy and overcast conditions.

MARINE





## GB30 UltraSafe™ Lithium Jump Starter

| PART # |        |   |
|--------|--------|---|
| 650317 | 159.95 | A |

### Reinventing Jump Starting.

The GB30 is a portable, mini, pocket sized lithium-ion jump starter for 12-volt lead-acid batteries. It can safely jump start a dead battery in seconds, like on a car, boat, motorcycle, ATV, RV, lawn mower, truck and more. The GB30 is powered by a High-Density NOCO Element lithium-ion battery that can hold its charge up to one year, and handle over 1,000 cycles.



### In The Box.

- GB30 Jump Starter
- 40" USB to Micro USB Cable
- 12V 2.1A USB Charger
- HD Battery Clamps
- User Guide & Warranty

## Genius Boost Sport GB20 400 Amp 12V UltraSafe Lithium Jump Starter



- Compact, yet powerful lithium jump starter rated at 400 Amps (4,650 Joules3S) - up to 20 jump starts on a single charge
- An ultra-safe and mistake-proof design with spark-proof technology and reverse polarity protection, which allow it to safely connect to any battery
- An ultra-bright 100 lumen LED flashlight with 7 light modes, including SOS and Emergency Strobe
- Recharge your personal devices on the go, like smartphones, tablets, e-watches and more - up to 4 smartphone recharges
- Designed for gas engines up to 4 Liters for motorcycles, ATVs, lawn mowers, cars and more (not recommended on diesel applications)

## Genius Boost Plus GB40 1000 Amp 12V UltraSafe Lithium Jump Starter



- Compact, yet powerful lithium jump starter rated at 1,000 Amps (7,000 Joules3S) - up to 20 jump starts on a single charge
- An ultra-safe and mistake-proof design with spark-proof technology and reverse polarity protection, which allow it to safely connect to any battery
- An ultra-bright 100 lumen LED flashlight with 7 light modes, including SOS and Emergency Strobe
- Recharge your personal devices on the go, like smartphones, tablets, e-watches and more - up to 4 smartphone recharges
- Designed for gas engines up to 6 Liters and diesel engines up to 3 Liters for cars, boats, lawn mowers and more

## Genius Boost HD GB70 2000 Amp 12V UltraSafe Lithium Jump Starter



- Compact, yet powerful lithium jump starter rated at 2,000 Amps (15,700 Joules3S) with spark-proof technology and reverse polarity protection - up to 40 jump starts on a single charge
- Enjoy portable 12-volt power from anywhere for tire pumps, inverters, lights and more; plus rapid recharging in just over 3 hours
- An ultra-bright 400 lumen LED flashlight with 7 light modes, including SOS and Emergency Strobe
- Recharge your personal devices on the go, like smartphones, tablets, e-watches and more - up to 8 smartphone recharges
- Designed for gas engines up to 8 Liters and diesel engines up to 6 Liters for cars, boats, trucks, tractors and more



| PART # |       |   |
|--------|-------|---|
| 650464 | 99.95 | A |



| PART # |        |   |
|--------|--------|---|
| 650465 | 124.95 | A |



| PART # |        |   |
|--------|--------|---|
| 650466 | 249.95 | A |

## GEN Mini 1 4A (4A/Bank) 12V 1 Bank On-Board Battery Charger

The GEN Mini On-Board Battery Charger is a rugged and compact waterproof charger for 12V lead acid batteries. It can be mounted onto virtually any vehicle, such as a boat, car, tractor, or RV. Safe to leave connected indefinitely; the GEN Mini interactively diagnoses, recovers, and charges Wet, Gel, MF and AGM batteries chemistries from 20-120Ah and maintains all battery sizes.



| PART # |       |   |
|--------|-------|---|
| 650279 | 78.95 | B |

## GEN Mini 2 8A (4A/Bank) 12V 2 Bank On-Board Battery Charger

The GEN Mini On-Board Battery Charger is a rugged and compact waterproof charger for 12V lead acid batteries. It can be mounted onto virtually any vehicle, such as a boat, car, tractor, or RV. Safe to leave connected indefinitely; the GEN Mini interactively diagnoses, recovers, and charges Wet, Gel, MF and AGM batteries chemistries from 20-120Ah and maintains all battery sizes.



| PART # |        |   |
|--------|--------|---|
| 650280 | 129.95 | B |

- accessories
- towables
- body
- controls
- electrical
- driveline
- engine
- fuel & intake
- chemicals
- tie downs
- tools
- towing & loading

- accessories
- towables
- body
- controls
- electrical
- driveline
- engine
- fuel & intake
- chemicals
- tie downs
- tools
- towing & loading

## NOCO **genius**<sup>®</sup> wicked smart chargers™

### WICKED TOUGH, WICKED SMART!

The GEN1 and Gen2 on-board battery charger s offer the perfect mix of high-technology and rugged construction. With a fully-sealed, waterproof housing, the GEN1 and GEN2 can be mounted directly onto a variety of applications including boats, tractors and a wide range of equipment. With the intelligent NOCO VosFX processor constantly monitoring the power input, attached battery and charger itself, the GEN1 and GEN2 chargers are capable of diagnosing, recovering, charging and maintaining batteries.

| DESCRIPTION                                     | PART # |        |   |
|---|--------|--------|---|
| GEN1<br>12V 1 Bank On-Board Battery Charger     | 650310 | 145.95 | E |
| GEN2<br>12V-24V 2 Bank On-Board Battery Charger | 650309 | 228.95 | E |



### WATERPROOF FULLY-SEALED



100% completely sealed. Protects our units from the most extreme environments and rated at IP68.

### RAPID CHARGING TECHNOLOGY



Charges batteries 2X faster than traditional linear battery chargers.

### HIGH FREQUENCY, HIGH EFFICIENCY



High-frequency, high-efficiency for a lightweight, compact charger.

### DESIGNED FOR SAFETY



Reverse polarity, short circuit, open circuit, spark proof, overheat, overcurrent & overcharge.

**3 YEAR LIMITED WARRANTY**

## NOCO **genius**<sup>®</sup> wicked smart chargers™

### BATTERY CHARGER ACCESSORIES

#### WICKED SMART OPTIONS

Genius accessories are designed to expand the versatility of the NOCO Genius multi-purpose battery chargers. The accessories offer different ways to connect to batteries, extend the reach of the chargers, add connections to multiple vehicles, replace existing connectors and more.

### BATTERY CLAMP CONNECTOR Fits G750-G7200

| PART # | PRICE | TYPE |
|--------|-------|------|
| 650213 | 14.95 | L    |

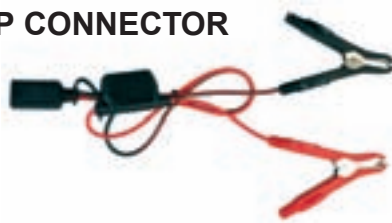

The GC001 Battery Clamp Connector works with NOCO Genius battery chargers and allows the battery chargers to connect quickly to any battery. Replace a lost connector or add a set to a convenient location for easy charging. The Quick Connect cable makes connecting the Battery Clamp Connector simple.

### EYELET TERMINAL CONNECTOR Fits G750-G7200

| PART # | PRICE | TYPE |
|--------|-------|------|
| 650214 | 10.95 | L    |



The GC002 Eyelet Terminal Connector works with NOCO Genius battery chargers and allows the battery chargers to connect quickly to any battery. Replace a lost connector or permanently mount one on your ATV, Motorcycle, Car, Boat or any other vehicle for easy charging. The Quick Connect cable makes connecting the Eyelet Terminal Connector simple.

### 12V PLUG CONNECTOR Fits G750-G3500

| PART # | PRICE | TYPE |
|--------|-------|------|
| 650215 | 15.95 | L    |



The GC003 12V Plug Connector works with NOCO Genius battery chargers and allows the battery chargers to charge and maintain your vehicle's battery by simply plugging into the 12V auxiliary plug/cigarette lighter. The Quick Connect cable makes connecting the 12V Plug Connector simple. Ideal for motorcycles where the battery compartment is difficult to access.

### 10' EXTENSION CABLE Fits G750-G7200

| PART # | PRICE | TYPE |
|--------|-------|------|
| 65016  | 17.95 | L    |



Extend the reach of your NOCO Genius battery charger and accessories with the GC004 10' Extension Cable. With Quick Connect connectors on both ends, connecting the 10' Extension Cable is simple. Using this accessory may increase the battery charger time.



## USB BATTERY PACKS + SOLAR PANELS

Rugged.  
Water, Dust and Impact Resistant.



### USB BATTERY PACK

3000mAh  
11.1Wh  
1A IN/OUT

An ultra-portable and lightweight USB battery pack for charging smartphones, HD cameras, GPS and more.

- Recharge from any powered USB port
- Up to 2 smartphone charges

| PART # | MFG # |       |   |
|--------|-------|-------|---|
| 650669 | XGB3  | 28.95 | B |



### USB BATTERY PACK + LED Flashlight

3000mAh  
11.1Wh  
1A IN/OUT

An ultra-portable and lightweight USB battery pack + LED tactical flashlight for charging smartphones, HD cameras, GPS and more.

- Recharge from any powered USB port
- Up to 2 smartphone charges

#### 5X Brighter

100% = 250 Lumens X 4 Hrs  
50% = 125 Lumens X 8 Hrs  
10% = 25 Lumens X 72 Hrs  
STROBE = 250 Lumens X 120 Hrs

| PART # | MFG # |       |   |
|--------|-------|-------|---|
| 650670 | XGB3L | 43.95 | B |

### USB BATTERY PACK

6000mAh  
22.2Wh  
2.1A IN/OUT

An ultra-portable and lightweight USB battery pack for charging smartphones, tablets, HD cameras, GPS, eReaders, music players and more.

- Recharge from any powered USB port
- Up to 4 smartphone charges

| PART # | MFG # |       |   |
|--------|-------|-------|---|
| 650671 | XGB6  | 58.95 | B |

- 10X MP3
- 6X GPS
- 5X HD Camera
- 3X eReader
- 1X Tablet



### 4W Solar Panel USB Battery Pack

An ultra-portable 4W smart solar charging solution that charges virtually any USB powered device, including smartphones, HD cameras, GPS and more. It's extremely compact and lightweight, which makes it perfect for any adventure.

In The Box:

- 4W Solar Panel
- 40" USB Cable
- 5V FLEX USB Regulator
- 650669 Battery Pack

| PART # | MFG #   |       |   |
|--------|---------|-------|---|
| 650672 | XGS4USB | 89.95 | B |

### 4W Solar Panel 12V Auto Kit

An ultra-portable 4W smart solar charging solution for cars, trucks, boats, motorcycles, ATVs, lawn mowers, snowmobiles and more. Ultra-compact design, powerful enough to maintain and automatically recover batteries.

In The Box:

- 4W Solar Panel
- 8' XGC Cable
- 12V Plug Connector
- Battery Clamp Connector
- 12V FLEX Regulator

| PART # | MFG #    |       |   |
|--------|----------|-------|---|
| 650673 | XGS4AUTO | 73.95 | B |



- accessories
- towables
- body
- controls
- electrical
- driveline
- engine
- fuel & intake
- chemicals
- tie downs
- tools
- towing & loading

MARINE

## 12 VOLT CELL PHONE CHARGER

How many times have you been out on the trail and your phone dies because of searching for a signal or from the cold temperatures? PowerMadd has an inexpensive solution! Our 12 Volt Cell Phone Charger installs easily to any machine with a 12-volt battery. The charger has a replaceable 2-amp in-line fuse and a micro USB connector. The charger will work with all phones with a micro usb charging port (will work with iPhones but requires adapter - NOT INCLUDED).

- Requires 12 DC volts
- Micro USB connector
- 2-amp in-line fuse for system protection
- Installs easily
- Compatible with most Android, Windows phones and iPhones(requires adapter).

Note: This cell phone charger can only be powered by a 12 volt DC battery. If connected to an AC electrical system, damage to the cell phone may result.  
 iPhone4 users: A micro usb to 30 pin adapter is required.  
 iPhone5 users: A micro usb to lightning port adapter is required.



| PART # | PRICE | STATUS |
|--------|-------|--------|
| 224055 | 30.00 | G      |

## OPTIMATE III ACCESSORIES

### EXTENSION CABLE

Extends the charger's reach by 8 feet



| PART # | PRICE | STATUS |
|--------|-------|--------|
| 67853D | 6.95  | G      |

### STANDARD WALL BRACKET

- Mounts to wall or workbench, and holds the Optimate III at a 45° angle for easy viewing of the control panel
- Storage for cord and clips



| PART # | PRICE | STATUS |
|--------|-------|--------|
| 67853B | 12.95 | G      |

## BATTERY CHARGER

6V - 12V • 1/2 AMP  
 ATV • MOTORCYCLE •  
 SNOWMOBILE • PWC

- This unit converts from 6 - 12 volts with a flick of a switch
- Just plug in charger output plug to charge the battery
- No mess, no removing battery
- Display packaged with full instructions



| PART #  | DESCRIPTION        | PRICE | STATUS |
|---------|--------------------|-------|--------|
| EM15600 | Battery Charger    | 16.95 | L      |
| EM15601 | "Y" Connector ONLY | 2.95  | L      |

## POCKET MULTI-TESTER

- Analyzing functions for Volts AC, Volts DC, amperes and ohms
- Operates on 1 AA battery (included)
- Instructions included



| PART # | DESCRIPTION  | PRICE | STATUS |
|--------|--------------|-------|--------|
| W2979  | Multi-Tester | 12.00 | G      |

## BATTERY/ALTERNATOR VOLTAGE CHECKER

- For all 12 volt systems
- Easy to read L.E.D lights
- Shows battery state-of-charge and level of alternator output



| PART # | DESCRIPTION     | PRICE | STATUS |
|--------|-----------------|-------|--------|
| W2980  | Voltage Checker | 9.95  | G      |

## CRIMPING TOOL

- Deluxe 4-way insulated crimping tool
- Crimper, wire stripper, wire cutter
- Insulated vinyl cushion grips



| PART # | DESCRIPTION   | PRICE | STATUS |
|--------|---------------|-------|--------|
| W190   | Crimping Tool | 4.50  | G      |

accessories  
 towables  
 body  
 controls  
 electrical  
 driveline  
 engine  
 fuel & intake  
 chemicals  
 tie downs  
 tools  
 towing & loading

MARINE

## TUBE STYLE BATTERY TESTER

- Easy to read color coded hydrometer
- Gives precise readings for status of battery cells
- Acid resistant



| PART # | DESCRIPTION    |      |   |
|--------|----------------|------|---|
| W1653  | Battery Tester | 4.15 | G |

## BATTERY CABLES

Sold each



| BULK |      |   |     | CARDED |       |      |   |
|------|------|---|-----|--------|-------|------|---|
| 1940 | 5.35 | E | 8"  | Black  | 11940 | 5.80 | E |
| 1941 | 6.20 | G | 12" | Black  | 11941 | 6.70 | G |
| 1942 | 6.45 | G | 16" | Black  | 11942 | 7.20 | G |
| 1943 | 7.60 | E | 20" | Black  | 11943 | 8.15 | G |

• Lugs size: 7/16"

• Polyvinyl insulation, brass lugs

|      |      |   |     |     |       |      |   |
|------|------|---|-----|-----|-------|------|---|
| 1932 | 5.35 | E | 8"  | Red | 11932 | 5.80 | L |
| 1933 | 6.20 | G | 12" | Red | 11933 | 6.70 | G |
| 1934 | 6.45 | G | 16" | Red | 11934 | 7.20 | G |
| 1935 | 7.60 | E | 20" | Red | 11935 | 8.15 | A |

• Lug sizes: 1/4" & 3/8"

• Polyvinyl insulation, brass lugs

## UNIVERSAL IN-LINE FUSE HOLDER

- 16 gauge wire
- Bakerlite with 20 AMP fuse



| PART #  | DESCRIPTION         |      |   |
|---------|---------------------|------|---|
| EM93320 | In-Line Fuse Holder | 1.95 | L |

## BATTERY TERMINAL CLEANER

- All metal construction
- Quality stainless steel brushes
- Cleans both battery post and terminals



| PART # | DESCRIPTION      |      |   |
|--------|------------------|------|---|
| W147   | Terminal Cleaner | 2.60 | G |

## BATTERY JUMPER CABLE SET

- 64" long
- 10 gauge
- Color coded terminal
- Clamps for safe and secure handling
- Display packaged



| PART #  | DESCRIPTION   |       |   |
|---------|---------------|-------|---|
| EM96300 | Jumper Cables | 12.95 | L |

## BATTERY CABLES



| PART # | LENGTH      | COLOR       |        |   |
|--------|-------------|-------------|--------|---|
| 1936   | 10 ft. roll | Red Cover   | 33.20  | B |
| 1944   | 10 ft. roll | Black Cover | 33.20  | B |
| 8597   | 50 ft. roll | Red Cover   | 150.30 | B |
| 8598   | 50 ft. roll | Black Cover | 150.30 | B |

## COPPER TERMINALS

- 1/4" & 3/8"
- Sold each
- Non-insulated



| PART # | DESCRIPTION   |      |   |
|--------|---------------|------|---|
| 8599   | 6 gauge, 3/8" | 1.45 | G |
| 8600   | 6 gauge, 1/4" | 1.45 | G |

## CABLE TERMINALS

- Sold each
- Steel clip



| PART # | DESCRIPTION |      |   |
|--------|-------------|------|---|
| 1937   | 3/8"        | 1.15 | L |
| 1938   | 1/4"        | 1.05 | L |

## NYLON INSULATED TERMINALS

- These handy terminals are quick and easy for wiring jobs using 10-18 gauge wire



| SIZE                     | PART # (PKG. 100) |       |   |
|--------------------------|-------------------|-------|---|
| 12-10 (.040) Female Side | DL695005          | 39.50 | A |

accessories

towables

body

controls

electrical

driveline

engine

fuel & intake

chemicals

tie downs

tools

towing & loading

MARINE



## SWITCHES & ALARMS

OEM QUALITY REPLACEMENT PARTS AT A LOW PRICE



326366



326367



326368



326369

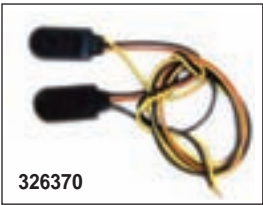

326370



326371



326372

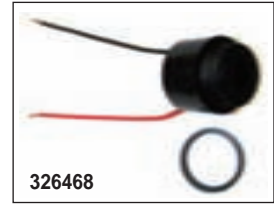

326468

| MAKE/MODEL           | YEAR  | DESCRIPTION           | OEM #                           | MFG #      | PART #        |                |
|----------------------|-------|-----------------------|---------------------------------|------------|---------------|----------------|
| <b>SEA-DOO</b>       |       |                       |                                 |            |               |                |
| 3D DI                | 06-07 | Rubber Switch Button  | 277000306                       | 004-101    | <b>329034</b> | <b>1.95</b> G  |
| 3D RFI               | 05    | Rubber Switch Button  | 277000306                       | 004-101    | <b>329034</b> | <b>1.95</b> G  |
| Challenges All       | 97-09 | Neutral Safety Switch | 278000888, 278001195, 204390315 | 004-110    | <b>326365</b> | <b>83.45</b> L |
| GS                   | 97    | VTS Switch Button     | 277000497                       | 004-100    | <b>329033</b> | <b>4.29</b> N  |
| GS                   | 00-01 | Rubber Switch Button  | 277000306                       | 004-101    | <b>329034</b> | <b>1.95</b> G  |
| GS                   | 97-01 | Over Heat/Key Alarm   | 278000978                       | 004-450    | <b>326468</b> | <b>50.05</b> L |
| GS 720               | 97-98 | Start Stop Switch     | 278001115                       | 004-117    | <b>326369</b> | <b>66.75</b> L |
| GSI                  | 97    | VTS Switch Button     | 277000497                       | 004-100    | <b>329033</b> | <b>4.29</b> N  |
| GSI 720              | 97    | Start Stop Switch     | 278001115                       | 004-117    | <b>326369</b> | <b>66.75</b> L |
| GSX                  | 96-97 | VTS Switch Button     | 277000497                       | 004-100    | <b>329033</b> | <b>4.29</b> N  |
| GSX                  | 96-98 | Start Stop Switch     | 278000427                       | 004-116    | <b>326368</b> | <b>66.75</b> L |
| GSX                  | 97-99 | Over Heat/Key Alarm   | 278000978                       | 004-450    | <b>326468</b> | <b>50.05</b> L |
| GSX Limited          | 98-99 | VTS Switch Button     | 277000497                       | 004-100    | <b>329033</b> | <b>4.29</b> N  |
| GSX RFI              | 99-00 | Rubber Switch Button  | 277000306                       | 004-101    | <b>329034</b> | <b>1.95</b> G  |
| GSX RFI              | 99-01 | VTS Switch Button     | 277000497                       | 004-100    | <b>329033</b> | <b>4.29</b> N  |
| GTI                  | 00-05 | Rubber Switch Button  | 277000306                       | 004-101    | <b>329034</b> | <b>1.95</b> G  |
| GTI                  | 07    | Safety Switch 4-Wire  | 278002055                       | 004-119    | <b>326371</b> | <b>69.95</b> L |
| GTI                  | 96-97 | Safety Switch 3-Wire  | 278000638                       | 004-119-01 | <b>326372</b> | <b>69.95</b> L |
| GTI                  | 97-99 | Over Heat/Key Alarm   | 278000978                       | 004-450    | <b>326468</b> | <b>50.05</b> L |
| GTI 720              | 96-97 | Safety Switch 3-Wire  | 278000638                       | 004-119-02 | <b>326373</b> | <b>69.95</b> L |
| GTI 720              | 97-98 | Start Stop Switch     | 278001115                       | 004-117    | <b>326369</b> | <b>66.75</b> L |
| GTI All Models       | 06-07 | Start Stop Switch     | 278001733                       | 004-114    | <b>326366</b> | <b>36.70</b> L |
| GTI LE               | 02-04 | Rubber Switch Button  | 277000306                       | 004-101    | <b>329034</b> | <b>1.95</b> G  |
| GTI LE RFI           | 03-05 | Rubber Switch Button  | 277000306                       | 004-101    | <b>329034</b> | <b>1.95</b> G  |
| GTI LE RFI           | 03-05 | Start Stop Switch     | 278001836                       | 004-118    | <b>326370</b> | <b>55.05</b> L |
| GTI LE RFI           | 05    | Safety Switch 4-Wire  | 278002055                       | 004-119    | <b>326371</b> | <b>69.95</b> L |
| GTS                  | 01    | Rubber Switch Button  | 277000306                       | 004-101    | <b>329034</b> | <b>1.95</b> G  |
| GTS                  | 95-00 | Safety Switch 3-Wire  | 278000638                       | 004-119-01 | <b>326372</b> | <b>69.95</b> L |
| GTS                  | 97-99 | Start Stop Switch     | 278000427                       | 004-116    | <b>326368</b> | <b>66.75</b> L |
| GTS 580              | 95-96 | Safety Switch 3-Wire  | 278000638                       | 004-119-02 | <b>326373</b> | <b>69.95</b> L |
| GTS 720              | 97    | Start Stop Switch     | 278001115                       | 004-117    | <b>326369</b> | <b>66.75</b> L |
| GTS 720              | 97-00 | Safety Switch 3-Wire  | 278000638                       | 004-119-02 | <b>326373</b> | <b>69.95</b> L |
| GTX                  | 00-02 | Rubber Switch Button  | 277000306                       | 004-101    | <b>329034</b> | <b>1.95</b> G  |
| GTX                  | 96-98 | Start Stop Switch     | 278000427                       | 004-116    | <b>326368</b> | <b>66.75</b> L |
| GTX                  | 97-01 | Over Heat/Key Alarm   | 278000978                       | 004-450    | <b>326468</b> | <b>50.05</b> L |
| GTX 4-Tec All Models | 02-07 | Start Stop Switch     | 278001733                       | 004-114    | <b>326366</b> | <b>36.70</b> L |
| GTX 650              | 95    | Safety Switch 3-Wire  | 278000638                       | 004-119-02 | <b>326373</b> | <b>69.95</b> L |
| GTX 800              | 97    | Start Stop Switch     | 278001115                       | 004-117    | <b>326369</b> | <b>66.75</b> L |

- accessories
- towables
- body
- controls
- electrical
- driveline
- engine
- fuel & intake
- chemicals
- tie downs
- tools
- towing & loading

MARINE



## SWITCHES &amp; ALARMS CONTINUED

| MAKE/MODEL               | YEAR  | DESCRIPTION           | OEM #                           | MFG #      | PART #        |              |   |
|--------------------------|-------|-----------------------|---------------------------------|------------|---------------|--------------|---|
| <b>SEA-DOO CONTINUED</b> |       |                       |                                 |            |               |              |   |
| GTX All                  | 07    | Safety Switch 4-Wire  | 278002055                       | 004-119    | <b>326371</b> | <b>69.95</b> | L |
| GTX DI                   | 00-01 | Rubber Switch Button  | 277000306                       | 004-101    | <b>329034</b> | <b>1.95</b>  | G |
| GTX LTD                  | 99    | Rubber Switch Button  | 277000306                       | 004-101    | <b>329034</b> | <b>1.95</b>  | G |
| GTX RFI                  | 98-01 | Over Heat/Key Alarm   | 278000978                       | 004-450    | <b>326468</b> | <b>50.05</b> | L |
| GTX RFI                  | 99-02 | Rubber Switch Button  | 277000306                       | 004-101    | <b>329034</b> | <b>1.95</b>  | G |
| GTX RFI 800              | 02    | Start Stop Switch     | 204390230, 278001405            | 004-115    | <b>326367</b> | <b>35.00</b> | L |
| HX                       | 95-97 | Start Stop Switch     | 278000427                       | 004-116    | <b>326368</b> | <b>66.75</b> | L |
| Islandia                 | 00-05 | Neutral Safety Switch | 278000888, 278001195, 204390315 | 004-110    | <b>326365</b> | <b>83.45</b> | L |
| LRV                      | 00-01 | Rubber Switch Button  | 277000306                       | 004-101    | <b>329034</b> | <b>1.95</b>  | G |
| LRV                      | 00-02 | Over Heat/Key Alarm   | 278000978                       | 004-450    | <b>326468</b> | <b>50.05</b> | L |
| LRV 951                  | 00-01 | Start Stop Switch     | 204390230, 278001405            | 004-115    | <b>326367</b> | <b>35.00</b> | L |
| LRV DI                   | 02    | Rubber Switch Button  | 277000306                       | 004-101    | <b>329034</b> | <b>1.95</b>  | G |
| RX                       | 00-02 | Rubber Switch Button  | 277000306                       | 004-101    | <b>329034</b> | <b>1.95</b>  | G |
| RX                       | 00-02 | VTS Switch Button     | 277000497                       | 004-100    | <b>329033</b> | <b>4.29</b>  | N |
| RX 951                   | 02    | Start Stop Switch     | 204390230, 278001405            | 004-115    | <b>326367</b> | <b>35.00</b> | L |
| RX DI                    | 00-03 | Rubber Switch Button  | 277000306                       | 004-101    | <b>329034</b> | <b>1.95</b>  | G |
| RX DI                    | 00-03 | VTS Switch Button     | 277000497                       | 004-100    | <b>329033</b> | <b>4.29</b>  | N |
| RX DI                    | 03    | Start Stop Switch     | 278001836                       | 004-118    | <b>326370</b> | <b>55.05</b> | L |
| RX DI LE                 | 02    | VTS Switch Button     | 277000497                       | 004-100    | <b>329033</b> | <b>4.29</b>  | N |
| RXP                      | 04-07 | Start Stop Switch     | 278001733                       | 004-114    | <b>326366</b> | <b>36.70</b> | L |
| RXP                      | 07    | Safety Switch 4-Wire  | 278002055                       | 004-119    | <b>326371</b> | <b>69.95</b> | L |
| RXP 255                  | 08    | Rubber Switch Button  | 277000306                       | 004-101    | <b>329034</b> | <b>1.95</b>  | G |
| RXT                      | 05-07 | Start Stop Switch     | 278001733                       | 004-114    | <b>326366</b> | <b>36.70</b> | L |
| RXT 255                  | 08    | Rubber Switch Button  | 277000306                       | 004-101    | <b>329034</b> | <b>1.95</b>  | G |
| SP                       | 95-97 | Start Stop Switch     | 278000427                       | 004-116    | <b>326368</b> | <b>66.75</b> | L |
| SP                       | 97    | VTS Switch Button     | 277000497                       | 004-100    | <b>329033</b> | <b>4.29</b>  | N |
| Speedsters All           | 97-09 | Neutral Safety Switch | 278000888, 278001195, 204390315 | 004-110    | <b>326365</b> | <b>83.45</b> | L |
| SPI                      | 95-96 | Start Stop Switch     | 278000427                       | 004-116    | <b>326368</b> | <b>66.75</b> | L |
| Sportsters All           | 97-06 | Neutral Safety Switch | 278000888, 278001195, 204390315 | 004-110    | <b>326365</b> | <b>83.45</b> | L |
| SPX                      | 95-97 | Start Stop Switch     | 278000427                       | 004-116    | <b>326368</b> | <b>66.75</b> | L |
| SPX                      | 96-99 | VTS Switch Button     | 277000497                       | 004-100    | <b>329033</b> | <b>4.29</b>  | N |
| XP                       | 00-02 | Rubber Switch Button  | 277000306                       | 004-101    | <b>329034</b> | <b>1.95</b>  | G |
| XP                       | 00-02 | VTS Switch Button     | 277000497                       | 004-100    | <b>329033</b> | <b>4.29</b>  | N |
| XP                       | 95    | Safety Switch 3-Wire  | 278000638                       | 004-119-01 | <b>326372</b> | <b>69.95</b> | L |
| XP                       | 95-96 | Start Stop Switch     | 278000427                       | 004-116    | <b>326368</b> | <b>66.75</b> | L |
| XP                       | 96-97 | VTS Switch Button     | 277000497                       | 004-100    | <b>329033</b> | <b>4.29</b>  | N |
| XP                       | 97-00 | Over Heat/Key Alarm   | 278000978                       | 004-450    | <b>326468</b> | <b>50.05</b> | L |
| XP 720                   | 95    | Safety Switch 3-Wire  | 278000638                       | 004-119-02 | <b>326373</b> | <b>69.95</b> | L |
| XP DI                    | 03-04 | Rubber Switch Button  | 277000306                       | 004-101    | <b>329034</b> | <b>1.95</b>  | G |
| XP DI                    | 03-04 | Start Stop Switch     | 278001836                       | 004-118    | <b>326370</b> | <b>55.05</b> | L |
| XP DI                    | 03-04 | VTS Switch Button     | 277000497                       | 004-100    | <b>329033</b> | <b>4.29</b>  | N |
| XP Limited               | 98-99 | VTS Switch Button     | 277000497                       | 004-100    | <b>329033</b> | <b>4.29</b>  | N |
| XP Limited 951           | 99    | Start Stop Switch     | 204390230, 278001405            | 004-115    | <b>326367</b> | <b>35.00</b> | L |
| XP LTD                   | 99    | Rubber Switch Button  | 277000306                       | 004-101    | <b>329034</b> | <b>1.95</b>  | G |
| <b>YAMAHA</b>            |       |                       |                                 |            |               |              |   |
| AR 210                   | 03-05 | Neutral Safety Switch | GP1-U8090-00-00                 | 004-109    | <b>326364</b> | <b>76.10</b> | L |
| Exciter 135 SE           | 99    | Neutral Safety Switch | GP1-U8090-00-00                 | 004-109    | <b>326364</b> | <b>76.10</b> | L |
| Exciter 270 TE           | 99    | Neutral Safety Switch | GP1-U8090-00-00                 | 004-109    | <b>326364</b> | <b>76.10</b> | L |
| LS 2000                  | 99-03 | Neutral Safety Switch | GP1-U8090-00-00                 | 004-109    | <b>326364</b> | <b>76.10</b> | L |
| LX 2000                  | 02    | Neutral Safety Switch | GP1-U8090-00-00                 | 004-109    | <b>326364</b> | <b>76.10</b> | L |
| LX 210                   | 03-05 | Neutral Safety Switch | GP1-U8090-00-00                 | 004-109    | <b>326364</b> | <b>76.10</b> | L |
| SR 230                   | 03-05 | Neutral Safety Switch | GP1-U8090-00-00                 | 004-109    | <b>326364</b> | <b>76.10</b> | L |
| XR 1800                  | 00-01 | Neutral Safety Switch | GP1-U8090-00-00                 | 004-109    | <b>326364</b> | <b>76.10</b> | L |

accessories

towables

body

controls

electrical

driveline

engine

fuel &amp; intake

chemicals

tie downs

tools

towing &amp; loading

MARINE

# ELECTRICAL



## STARTERS • STARTER DRIVES & STARTER REBUILD KITS

New replacement starter replacement parts meet or exceed the original manufacturer specifications

- 100% O.E.M interchangeable
- Double and single o-ring design for better water seal
- Rubber seals on top and bottom side of unit to ensure dry operation for longer life



| MODEL                  | YEAR  | ENGINE | OEM #         | OPTIONS        | STARTER         | STARTER DRIVE | STARTER REPAIR KIT |
|------------------------|-------|--------|---------------|----------------|-----------------|---------------|--------------------|
| <b>ARCTIC CAT</b>      |       |        |               |                |                 |               |                    |
| Barracuda              | 94-95 | 639cc  | 3008-093      | Hitachi System | 248000 113.19 L |               | 249125 22.63 G     |
| Daytona                | 93-94 | 639cc  | 3008-093      | Hitachi System | 248000 113.19 L |               | 249125 22.63 G     |
| Daytona                | 95    | 639cc  | 3008-327      | Hitachi System | 248000 113.19 L |               | 249125 22.63 G     |
| Daytona 770            | 96-97 | 768cc  | 3008-462      | Hitachi System | 248000 113.19 L |               | 249125 22.63 G     |
| Daytona 1000           | 97    | 999cc  | 3008-536      | Hitachi System | 248000 113.19 L |               | 249125 22.63 G     |
| Monte Carlo 640        | 94-95 | 639cc  | 3008-093      | Hitachi System | 248000 113.19 L |               | 249125 22.63 G     |
| Monte Carlo 640        | 96-97 | 639cc  | 3008-327      | Hitachi System | 248000 113.19 L |               | 249125 22.63 G     |
| Monte Carlo 770        | 96-97 | 768cc  | 3008-462      | Hitachi System | 248000 113.19 L |               | 249125 22.63 G     |
| Monte Carlo 900        | 96    | 900cc  | 3008-327      | Hitachi System | 248000 113.19 L |               | 249125 22.63 G     |
| Monte Carlo 1000       | 97    | 999cc  | 3008-536      | Hitachi System | 248000 113.19 L |               | 249125 22.63 G     |
| Montego 640            | 94-97 | 639cc  | 3008-327      | Hitachi System | 248000 113.19 L |               | 249125 22.63 G     |
| Montego Deluxe 640     | 94-97 | 639cc  | 3008-327      | Hitachi System | 248000 113.19 L |               | 249125 22.63 G     |
| Tigershark 640         | 93    | 639cc  | 3008-093      | Hitachi System | 248000 113.19 L |               | 249125 22.63 G     |
| Tigershark 900         | 95    | 900cc  | 3008-093      | Hitachi System | 248000 113.19 L |               | 249125 22.63 G     |
| TS640                  | 98-99 | 639cc  | 3008-536      | Hitachi System | 248000 113.19 L |               | 249125 22.63 G     |
| TS770                  | 98-99 | 768cc  | 3008-462      | Hitachi System | 248000 113.19 L |               | 249125 22.63 G     |
| TS770L                 | 98-99 | 768cc  | 3008-462      | Hitachi System | 248000 113.19 L |               | 249125 22.63 G     |
| TS770R                 | 98-99 | 768cc  | 3008-462      | Hitachi System | 248000 113.19 L |               | 249125 22.63 G     |
| TS900L                 | 99    | 900cc  | 3008-327      | Hitachi System | 248000 113.19 L |               | 249125 22.63 G     |
| TS1000L                | 98    | 999cc  | 3008-536      | Hitachi System | 248000 113.19 L |               | 249125 22.63 G     |
| TS1000R                | 98    | 999cc  | 3008-536      | Hitachi System | 248000 113.19 L |               | 249125 22.63 G     |
| TS1100Li               | 99    | 1100cc | 3008-536      | Hitachi System | 248000 113.19 L |               | 249125 22.63 G     |
| TS1100R                | 99    | 695cc  | 3008-536      | Hitachi System | 248000 113.19 L |               | 249125 22.63 G     |
| <b>HONDA</b>           |       |        |               |                |                 |               |                    |
| Aquatrax F-12          | 02-07 | 1235cc | 31200-HW1-671 | Mitsuba System | 248006 113.19 L |               |                    |
| Aquatrax F-12X         | 02-07 | 1235cc | 31200-HW1-671 | Mitsuba System | 248006 113.19 L |               |                    |
| Aquatrax F-12X GPSCAPE | 05-07 | 1235cc | 31200-HW1-671 | Mitsuba System | 248006 113.19 L |               |                    |
| Aquatrax R-12          | 04-06 | 1235cc | 31200-HW1-671 | Mitsuba System | 248006 113.19 L |               |                    |
| Aquatrax R-12X         | 03-07 | 1235cc | 31200-HW1-671 | Mitsuba System | 248006 113.19 L |               |                    |
| <b>KAWASAKI</b>        |       |        |               |                |                 |               |                    |
| JB650 Jet Mate         | 89-92 | 650cc  | 21163-3714    | A1-A4          | 248001 102.08 L |               | 249101 22.63 G     |
| JF650 TS               | 89-90 | 650cc  | 21163-3702    | B1-B2          | 248001 102.08 L |               | 249101 22.63 G     |
| JF650 TS               | 91-96 | 650cc  | 21163-3709    | B3-B8          | 248001 102.08 L |               | 249101 22.63 G     |

accessories  
towables  
body  
controls  
electrical  
driveline  
engine  
fuel & intake  
chemicals  
tie downs  
tools  
towing & loading

MARINE



## STARTERS • STARTER DRIVES &amp; STARTER REBUILD KITS CONT'D

| MODEL                     | YEAR  | ENGINE | OEM #        | OPTIONS | STARTER         | STARTER DRIVE  | STARTER REPAIR KIT |
|---------------------------|-------|--------|--------------|---------|-----------------|----------------|--------------------|
| <b>KAWASAKI CONTINUED</b> |       |        |              |         |                 |                |                    |
| JF650 X2                  | 86-87 | 650cc  | 21163-3712   | A1-A2   | 248001 102.08 L |                | 249101 22.63 G     |
| JF650 X2                  | 88-90 | 650cc  | 21163-3702   | A3-A5   | 248001 102.08 L |                | 249101 22.63 G     |
| JF650 X2                  | 91-94 | 650cc  | 21163-3712   | A6-A9   | 248001 102.08 L |                | 249101 22.63 G     |
| JF650 X2                  | 95    | 650cc  | 21163-3714   | A10     | 248001 102.08 L |                | 249101 22.63 G     |
| JH750 750 SS              | 92-97 | 743cc  | 21163-3709   | A1-A4   | 248001 102.08 L |                | 249101 22.63 G     |
| JH750 750 Zxi             | 95-97 | 743cc  | 21163-3709   | C1-C3   | 248001 102.08 L |                | 249101 22.63 G     |
| JH750 Super Sport XI      | 93-97 | 743cc  | 21163-3709   | B1-B3   | 248001 102.08 L |                | 249101 22.63 G     |
| JH750 Xi Sport            | 98-99 | 743cc  | 21163-3709   | G1-G2   | 248001 102.08 L |                | 249101 22.63 G     |
| JH750 XiR                 | 94    | 743cc  | 21163-3709   | D1      | 248001 102.08 L |                | 249101 22.63 G     |
| JH900 900 Zxi             | 95-97 | 891cc  | 21163-3709   | A1-A3   | 248001 102.08 L |                | 249101 22.63 G     |
| JH1100 1100 Zxi           | 96-00 | 1071cc | 21163-3709   | A1-A5   | 248001 102.08 L |                | 249101 22.63 G     |
| JH1100 1100 Zxi           | 01-03 | 1071cc | 21163-3714   | A6-A8   | 248001 102.08 L |                | 249101 22.63 G     |
| JH1100 Ultra 130 D.I.     | 01-04 | 1071cc | 21163-3714   | B1-B4   | 248001 102.08 L |                | 249101 22.63 G     |
| JH1200 Ultra 150          | 99-00 | 1176cc | 21163-3715   | A1-A2   | 248005 113.19 L |                |                    |
| JH1200 Ultra 150          | 01-05 | 1176cc | 21163-3719   | A3-A4   | 248005 113.19 L |                |                    |
| JL650 SC                  | 91-95 | 650cc  | 21163-3709   | A1-A5   | 248001 102.08 L |                | 249101 22.63 G     |
| JS400                     | 76    | 400cc  | 21163-3710   | A3      | 248141 113.19 L | 248155 14.02 L | 248144 56.52 L     |
| JS440                     | 77-92 | 440cc  | 21163-3710   | A1-A16  | 248141 113.19 L | 248155 14.02 L | 248144 56.52 L     |
| JS550                     | 82-89 | 550cc  | 21163-3710   | A1-A8   | 248141 113.19 L | 248155 14.02 L | 248144 56.52 L     |
| JS550 550 SX              | 90    | 550cc  | 21163-3003YR | B1      | 248141 113.19 L | 248155 14.02 L | 248144 56.52 L     |
| JS550 550 SX              | 91-95 | 550cc  | 21163-3710   | C1-C5   | 248141 113.19 L | 248155 14.02 L | 248144 56.52 L     |
| JS650 650 SX              | 87    | 650cc  | 21163-3712   | A1      | 248001 102.08 L |                | 249101 22.63 G     |
| JS650 650 SX              | 88-90 | 650cc  | 21163-3702   | A2-A4   | 248001 102.08 L |                | 249101 22.63 G     |
| JS650 650 SX              | 91-93 | 650cc  | 21163-3709   | B1-B3   | 248001 102.08 L |                | 249101 22.63 G     |
| JS750 750 SX              | 92-95 | 743cc  | 21163-3709   | A1-A4   | 248001 102.08 L |                | 249101 22.63 G     |
| JS750 750 Sxi             | 95-97 | 743cc  | 21163-3709   | B1-B3   | 248001 102.08 L |                | 249101 22.63 G     |
| JS750 750 SXi Pro         | 98-02 | 743cc  | 21163-3709   | C1-C5   | 248001 102.08 L |                | 249101 22.63 G     |
| JS800 SX-R                | 03-12 | 781cc  | 21163-3714   | A1-ACF  | 248001 102.08 L |                | 249101 22.63 G     |
| JT750 750 STX             | 98    | 743cc  | 21163-3709   | C1      | 248001 102.08 L |                | 249101 22.63 G     |
| JT750 ST                  | 94-95 | 743cc  | 21163-3709   | A1-A2   | 248001 102.08 L |                | 249101 22.63 G     |
| JT750 STS                 | 95-97 | 743cc  | 21163-3709   | B1-B3   | 248001 102.08 L |                | 249101 22.63 G     |
| JT900 900 STS             | 01-02 | 891cc  | 21163-3709   | B3-B4   | 248001 102.08 L |                | 249101 22.63 G     |
| JT900 900 STX             | 97-02 | 891cc  | 21163-3709   | A1-A2   | 248001 102.08 L |                | 249101 22.63 G     |
| JT900 900 STX             | 03-06 | 891cc  | 21163-3714   | D1      | 248001 102.08 L |                | 249101 22.63 G     |
| JT1100 1100 STX           | 97-99 | 1071cc | 21163-3709   | A1      | 248001 102.08 L |                | 249101 22.63 G     |
| JT1100 1100 STX D.I.      | 00-02 | 1071cc | 21163-3709   | C1      | 248001 102.08 L |                | 249101 22.63 G     |
| JT1100 1100 STX D.I.      | 03    | 1071cc | 21163-3714   | G1      | 248001 102.08 L |                | 249101 22.63 G     |
| JT1200 STX-12F            | 03-07 | 1199cc | 21163-3721   | B1-B2   | 248134 141.52 G |                |                    |
| JT1200 STX-R              | 02-05 | 1176cc | 21163-3719   | A1-A2   | 248005 113.19 L |                |                    |
| JT1500 STX                | 09-10 | 1498cc | 21163-3721   | D9F-DAF | 248134 141.52 G |                |                    |
| JT1500 STX-15F            | 04-15 | 1498cc | 21163-3721   | A1-AEF  | 248134 141.52 G |                |                    |
| JT1500 Ultra 250X         | 07-09 | 1498cc | 21163-3721   | B7-B9   | 248134 141.52 G |                |                    |
| JT1500 Ultra 260LX        | 09-10 | 1498cc | 21163-3721   | F9F-FAF | 248134 141.52 G |                |                    |
| JT1500 Ultra 260X         | 09-10 | 1498cc | 21163-3721   | E9F-EAF | 248134 141.52 G |                |                    |
| JT1500 Ultra 300X         | 11-13 | 1498cc | 21163-3721   | HBF-HDF | 248134 141.52 G |                |                    |
| JT1500 Ultra 300LX        | 11-13 | 1498cc | 21163-3721   | JBF-JDF | 248134 141.52 G |                |                    |

accessories

towables

body

controls

electrical

driveline

engine

fuel &amp; intake

chemicals

tie downs

tools

towing &amp; loading

MARINE

# ELECTRICAL

## STARTERS • STARTER DRIVES & STARTER REBUILD KITS CONT'D

| MODEL                           | YEAR  | ENGINE | OEM #       | OPTIONS        | STARTER | STARTER DRIVE | STARTER REPAIR KIT |
|---------------------------------|-------|--------|-------------|----------------|---------|---------------|--------------------|
| <b>KAWASAKI CONTINUED</b>       |       |        |             |                |         |               |                    |
| JT1500 Ultra 310X               | 14-15 | 1498cc | 21163-3721  |                | 248134  | 141.52 G      |                    |
| JT1500 Ultra 310LX              | 14-15 | 1498cc | 21163-3721  |                | 248134  | 141.52 G      |                    |
| JT1500 Ultra 310R               | 14-15 | 1498cc | 21163-3721  |                | 248134  | 141.52 G      |                    |
| JT1500 Ultra LX                 | 07-15 | 1498cc | 21163-3721  | C7-C9          | 248134  | 141.52 G      |                    |
| <b>POLARIS</b>                  |       |        |             |                |         |               |                    |
| Freedom                         | 02-04 | 701cc  | 4010675     | Mitsuba System | 248001  | 102.08 L      | 249125 22.63 G     |
| Genesis                         | 99-02 | 1165cc | 4060118     | Mitsuba System | 248001  | 102.08 L      | 249125 22.63 G     |
| Genesis FFI                     | 00    | 1165cc | 4060118     | Mitsuba System | 248001  | 102.08 L      | 249125 22.63 G     |
| Genesis Ficht                   | 99    | 1165cc | 4060118     | Mitsuba System | 248001  | 102.08 L      | 249125 22.63 G     |
| Genesis I                       | 01    | 1165cc | 4060118     | Mitsuba System | 248001  | 102.08 L      | 249125 22.63 G     |
| Genesis I                       | 02-04 | 1165cc | 4010675     | Mitsuba System | 248001  | 102.08 L      | 249125 22.63 G     |
| Hurricane                       | 96-97 | 701cc  | 4060118     | Mitsuba System | 248001  | 102.08 L      | 249125 22.63 G     |
| MSX 110 Turbo                   | 04    | 750cc  | 0451411     | Mitsuba System | 248087  | 170.13 L      |                    |
| MSX 140                         | 03-04 | 1192cc | 4010675     | Mitsuba System | 248001  | 102.08 L      | 249125 22.63 G     |
| MSX 150 Turbo                   | 04    | 750cc  | 0451411     | Mitsuba System | 248087  | 170.13 L      |                    |
| Octane                          | 02-04 | 777cc  | 4010675     | Mitsuba System | 248001  | 102.08 L      | 249125 22.63 G     |
| Pro 785                         | 99-00 | 779cc  | 3240281     | Mitsuba System | 248001  | 102.08 L      | 249125 22.63 G     |
| Pro 1200                        | 00-01 | 1165cc | 4060118     | Mitsuba System | 248001  | 102.08 L      | 249125 22.63 G     |
| SL 650                          | 92-95 | 650cc  | 3240110     | Mitsuba System | 248001  | 102.08 L      | 249125 22.63 G     |
| SL 650 STD                      | 95    | 650cc  | 3240110     | Mitsuba System | 248001  | 102.08 L      | 249125 22.63 G     |
| SL 700                          | 96-97 | 701cc  | 4060118     | Mitsuba System | 248001  | 102.08 L      | 249125 22.63 G     |
| SL 700 Deluxe                   | 97    | 701cc  | 4060118     | Mitsuba System | 248001  | 102.08 L      | 249125 22.63 G     |
| SL 750                          | 93-95 | 750cc  | 3240110     | Mitsuba System | 248001  | 102.08 L      | 249125 22.63 G     |
| SL 780                          | 96-97 | 779cc  | 3240281     | Mitsuba System | 248001  | 102.08 L      | 249125 22.63 G     |
| SL 900                          | 96-97 | 900cc  | 4060118     | Mitsuba System | 248001  | 102.08 L      | 249125 22.63 G     |
| SL 1050                         | 97    | 1051cc | 4060118     | Mitsuba System | 248001  | 102.08 L      | 249125 22.63 G     |
| SLH                             | 98-01 | 701cc  | 4060118     | Mitsuba System | 248001  | 102.08 L      | 249125 22.63 G     |
| SLT 700                         | 96-97 | 701cc  | 4060118     | Mitsuba System | 248001  | 102.08 L      | 249125 22.63 G     |
| SLT 750                         | 94-95 | 750cc  | 3240110     | Mitsuba System | 248001  | 102.08 L      | 249125 22.63 G     |
| SLT 780                         | 96-97 | 779cc  | 3240281     | Mitsuba System | 248001  | 102.08 L      | 249125 22.63 G     |
| SLTH                            | 98-99 | 701cc  | 4060118     | Mitsuba System | 248001  | 102.08 L      | 249125 22.63 G     |
| SLTX                            | 96-99 | 1051cc | 4060118     | Mitsuba System | 248001  | 102.08 L      | 249125 22.63 G     |
| SLX                             | 99    | 1051cc | 4060118     | Mitsuba System | 248001  | 102.08 L      | 249125 22.63 G     |
| SLX                             | 00-01 | 1165cc | 4060118     | Mitsuba System | 248001  | 102.08 L      | 249125 22.63 G     |
| SLX 780                         | 95-96 | 779cc  | 3240281     | Mitsuba System | 248001  | 102.08 L      | 249125 22.63 G     |
| SLX Pro 785                     | 97-98 | 779cc  | 3240281     | Mitsuba System | 248001  | 102.08 L      | 249125 22.63 G     |
| SLXH                            | 98    | 1051cc | 4060118     | Mitsuba System | 248001  | 102.08 L      | 249125 22.63 G     |
| Virage                          | 00-01 | 701cc  | 4060118     | Mitsuba System | 248001  | 102.08 L      | 249125 22.63 G     |
| Virage                          | 02-04 | 701cc  | 4010675     | Mitsuba System | 248001  | 102.08 L      | 249125 22.63 G     |
| Virage I                        | 02-04 | 777cc  | 4010675     | Mitsuba System | 248001  | 102.08 L      | 249125 22.63 G     |
| Virage TX                       | 00-02 | 1165cc | 4060118     | Mitsuba System | 248001  | 102.08 L      | 249125 22.63 G     |
| Virage TXI                      | 01-02 | 1165cc | 4060118     | Mitsuba System | 248001  | 102.08 L      | 249125 22.63 G     |
| Wave Runner 650, 750, 900, 1100 | All   |        | 3240110     | Mitsuba System | 248001  | 102.08 L      | 249125 22.63 G     |
| <b>SEA-DOO</b>                  |       |        |             |                |         |               |                    |
| 3D DI                           | 04-05 | 782cc  | 278-001-936 | Denso System   | 248142  | 113.19 L      | 248222 27.64 G     |
| 3D DI                           | 06-07 | 951cc  | 278-001-937 | Mitsuba System | 248001  | 102.08 L      | 249125 22.63 G     |
| 3D DI                           | 07    | 1494cc | 420-888-994 | Mitsuba System | 248004  | 113.19 L      |                    |
| GS                              | 97    | 718cc  | 278-000-485 | Denso System   | 248139  | 113.19 L      | 248145 56.52 L     |

accessories  
towables  
body  
controls  
electrical  
driveline  
engine  
fuel & intake  
chemicals  
tie downs  
tools  
towing & loading

MARINE

## STARTERS • STARTER DRIVES & STARTER REBUILD KITS CONT'D

| MODEL                    | YEAR  | ENGINE | OEM #       | OPTIONS        | STARTER         | STARTER DRIVE  | STARTER REPAIR KIT |
|--------------------------|-------|--------|-------------|----------------|-----------------|----------------|--------------------|
| <b>SEA-DOO CONTINUED</b> |       |        |             |                |                 |                |                    |
| GS                       | 98-01 | 718cc  | 278-001-300 | Denso System   | 248139 113.19 L |                | 248145 56.52 L     |
| GSI                      | 97    | 718cc  | 278-000-485 | Denso System   | 248139 113.19 L |                | 248145 56.52 L     |
| GSX                      | 96    | 782cc  | 278-000-577 | Denso System   | 248140 113.19 L | 248158 14.02 L | 248227 17.50 G     |
| GSX                      | 97    | 782cc  | 278-001-038 | Denso System   | 248140 113.19 L | 248158 14.02 L | 248227 17.50 G     |
| GSX LTD                  | 98-99 | 951cc  | 278-000-987 | Mitsuba System | 248001 102.08 L |                | 249125 22.63 G     |
| GSX RFI                  | 99-01 | 782cc  | 278-001-497 | Denso System   | 248142 113.19 L | 248222 27.64 G | 248227 17.50 G     |
| GTI                      | 96    | 718cc  | 278-000-485 | 2 Passenger    | 248139 113.19 L |                | 248145 56.52 L     |
| GTI                      | 96-97 | 718cc  | 278-000-485 | 3-Passenger    | 248139 113.19 L |                | 248145 56.52 L     |
| GTI                      | 98-03 | 718cc  | 278-001-300 | Denso System   | 248139 113.19 L |                | 248145 56.52 L     |
| GTI                      | 04-05 | 718cc  | 278-001-935 | Denso System   | 248139 113.19 L |                | 248145 56.52 L     |
| GTI                      | 06-08 | 1494cc | 420-888-994 | Mitsuba System | 248004 113.19 L |                |                    |
| GTI                      | 09-11 | 1494cc | 420-888-996 | Mitsuba System | 248004 113.19 L |                |                    |
| GTI LTD                  | 11    | 1494cc | 420-888-996 | Mitsuba System | 248004 113.19 L |                |                    |
| GTI LE                   | 02-03 | 718cc  | 278-001-300 | Denso System   | 248139 113.19 L |                | 248145 56.52 L     |
| GTI LE                   | 04    | 718cc  | 278-001-935 | Denso System   | 248139 113.19 L |                | 248145 56.52 L     |
| GTI LE                   | 05    | 782cc  | 278-001-936 | Denso System   | 248142 113.19 L | 248222 27.64 G | 248227 17.50 G     |
| GTI RFI                  | 03    | 782cc  | 278-001-497 | Denso System   | 248142 113.19 L | 248222 27.64 G | 248227 17.50 G     |
| GTI RFI                  | 04-05 | 782cc  | 278-001-936 | Denso System   | 248142 113.19 L | 248222 27.64 G | 248227 17.50 G     |
| GTI SE                   | 06-08 | 1494cc | 420-888-994 | Mitsuba System | 248004 113.19 L |                |                    |
| GTI SE                   | 09-11 | 1494cc | 420-888-996 | Mitsuba System | 248004 113.19 L |                |                    |
| GTS                      | 92    | 581cc  | 278-000-186 | Denso System   | 248138 113.19 L | 248158 14.02 L | 248145 56.52 L     |
| GTS                      | 93-94 | 581cc  | 278-000-316 | Denso System   | 248138 113.19 L | 248158 14.02 L | 248145 56.52 L     |
| GTS                      | 95    | 581cc  | 278-000-485 | 2-Passenger    | 248139 113.19 L |                | 248145 56.52 L     |
| GTS                      | 95-96 | 581cc  | 278-000-485 | 3-Passenger    | 248139 113.19 L |                | 248145 56.52 L     |
| GTS                      | 97    | 718cc  | 278-000-485 | Denso System   | 248139 113.19 L |                | 248145 56.52 L     |
| GTS                      | 98-01 | 718cc  | 278-001-300 | Denso System   | 248139 113.19 L |                | 248145 56.52 L     |
| GTS                      | 11    | 1494cc | 420-888-996 | Mitsuba System | 248004 113.19 L |                |                    |
| GTS Pro                  | 11    | 1494cc | 420-888-996 | Mitsuba System | 248004 113.19 L |                |                    |
| GTX                      | 92    | 581cc  | 278-000-186 | Denso System   | 248138 113.19 L | 248158 14.02 L | 248145 56.52 L     |
| GTX                      | 93-94 | 650cc  | 278-000-316 | Denso System   | 248138 113.19 L | 248158 14.02 L | 248145 56.52 L     |
| GTX                      | 95    | 650cc  | 278-000-485 | 2-Passenger    | 248139 113.19 L |                | 248145 56.52 L     |
| GTX                      | 95    | 650cc  | 278-000-485 | 3-Passenger    | 248139 113.19 L |                | 248145 56.52 L     |
| GTX                      | 96    | 782cc  | 278-000-577 | Denso System   | 248140 113.19 L | 248158 14.02 L | 248227 17.50 G     |
| GTX                      | 97    | 782cc  | 278-001-038 | Denso System   | 248140 113.19 L | 248158 14.02 L | 248227 17.50 G     |
| GTX                      | 98-02 | 951cc  | 278-000-987 | Mitsuba System | 248001 102.08 L |                | 249125 22.63 G     |
| GTX                      | 07    | 1494cc | 420-888-996 | Mitsuba System | 248004 113.19 L |                |                    |
| GTX                      | 08    | 1494cc | 420-888-994 | Mitsuba System | 248004 113.19 L |                |                    |
| GTX                      | 09-11 | 1494cc | 420-888-996 | Mitsuba System | 248004 113.19 L |                |                    |
| GTX 4-TEC                | 02    | 1494cc | 290-888-993 | Mitsuba System | 248004 113.19 L |                |                    |
| GTX 4-TEC                | 03-08 | 1494cc | 420-888-994 | Mitsuba System | 248004 113.19 L |                |                    |
| GTX DI                   | 00-03 | 951cc  | 278-000-987 | Mitsuba System | 248001 102.08 L |                | 249125 22.63 G     |
| GTX iS                   | 09-11 | 1494cc | 420-888-996 | Mitsuba System | 248004 113.19 L |                |                    |
| GTX LTD                  | 07-08 | 1494cc | 420-888-996 | Mitsuba System | 248004 113.19 L |                |                    |
| GTX LTD iS               | 09-11 | 1494cc | 420-888-996 | Mitsuba System | 248004 113.19 L |                |                    |
| GTX RFI                  | 98    | 782cc  | 278-001-301 | Denso System   | 248140 113.19 L | 248158 14.02 L | 248227 17.50 G     |
| GTX RFI                  | 99-02 | 782cc  | 278-001-497 | Denso System   | 248142 113.19 L | 248222 27.64 G | 248227 17.50 G     |
| GTX Wake                 | 05-07 | 1494cc | 420-888-994 | Mitsuba System | 248004 113.19 L |                |                    |
| Wake                     | 08    | 1494cc | 420-888-994 | Mitsuba System | 248004 113.19 L |                |                    |
| HX                       | 95-97 | 718cc  | 278-000-485 | Denso System   | 248139 113.19 L |                | 248145 56.52 L     |
| LRV                      | 00-01 | 951cc  | 278-000-987 | Mitsuba System | 248001 102.08 L |                | 249125 22.63 G     |
| LRV DI                   | 02-03 | 951cc  | 278-000-987 | Mitsuba System | 248001 102.08 L |                | 249125 22.63 G     |
| RX                       | 00-02 | 951cc  | 278-000-987 | Mitsuba System | 248001 102.08 L |                | 249125 22.63 G     |
| RX DI                    | 00-03 | 951cc  | 278-000-987 | Mitsuba System | 248001 102.08 L |                | 249125 22.63 G     |
| RX X                     | 01    | 951cc  | 278-000-987 | Mitsuba System | 248001 102.08 L |                | 249125 22.63 G     |

- accessories
- towables
- body
- controls
- electrical
- driveline
- engine
- fuel & intake
- chemicals
- tie downs
- tools
- towing & loading

# MARINE

## STARTERS • STARTER DRIVES & STARTER REBUILD KITS CONT'D

| MODEL                    | YEAR  | ENGINE | OEM #       | OPTIONS        | STARTER         | STARTER DRIVE  | STARTER REPAIR KIT |
|--------------------------|-------|--------|-------------|----------------|-----------------|----------------|--------------------|
| <b>SEA-DOO CONTINUED</b> |       |        |             |                |                 |                |                    |
| RXP                      | 04-08 | 1494cc | 420-888-994 | Mitsuba System | 248004 113.19 L |                |                    |
| RXP                      | 09    | 1494cc | 420-888-996 | Mitsuba System | 248004 113.19 L |                |                    |
| RXP X                    | 08-11 | 1494cc | 420-888-996 | Mitsuba System | 248004 113.19 L |                |                    |
| RXT                      | 05-08 | 1494cc | 420-888-994 | Mitsuba System | 248004 113.19 L |                |                    |
| RXT                      | 09-11 | 1494cc | 420-888-996 | Mitsuba System | 248004 113.19 L |                |                    |
| RXT iS                   | 09-11 | 1494cc | 420-888-996 | Mitsuba System | 248004 113.19 L |                |                    |
| RXT X                    | 09-11 | 1494cc | 420-888-996 | Mitsuba System | 248004 113.19 L |                |                    |
| RXT X aS                 | 11    | 1494cc |             |                | 248004 113.19 L |                |                    |
| SP                       | 92    | 581cc  | 278-000-186 | Denso System   | 248138 113.19 L | 248158 14.02 L | 248145 56.52 L     |
| SP                       | 93-94 | 581cc  | 278-000-316 | Denso System   | 248138 113.19 L | 248158 14.02 L | 248145 56.52 L     |
| SP                       | 95-96 | 581cc  | 278-000-485 | Denso System   | 248139 113.19 L |                | 248145 56.52 L     |
| SP                       | 97    | 718cc  | 278-000-485 | Denso System   | 248139 113.19 L |                | 248145 56.52 L     |
| SPI                      | 93-94 | 581cc  | 278-000-316 | Denso System   | 248138 113.19 L | 248158 14.02 L | 248145 56.52 L     |
| SPI                      | 95-96 | 581cc  | 278-000-485 | Denso System   | 248139 113.19 L |                | 248145 56.52 L     |
| SPX                      | 93    | 581cc  | 278-000-316 | Denso System   | 248138 113.19 L | 248158 14.02 L | 248145 56.52 L     |
| SPX                      | 94    | 650cc  | 278-000-316 | Denso System   | 248138 113.19 L | 248158 14.02 L | 248145 56.52 L     |
| SPX                      | 95    | 650cc  | 278-000-485 | Denso System   | 248139 113.19 L |                | 248145 56.52 L     |
| SPX                      | 96    | 718cc  | 278-000-485 | Denso System   | 248139 113.19 L |                | 248145 56.52 L     |
| SPX                      | 97    | 782cc  | 278-000-485 | Denso System   | 248139 113.19 L |                | 248145 56.52 L     |
| SPX                      | 98-99 | 782cc  | 278-001-301 | Denso System   | 248140 113.19 L | 248158 14.02 L | 248227 17.50 G     |
| Wake                     | 09-11 | 1494cc | 420-888-996 | Mitsuba System | 248004 113.19 L |                |                    |
| Wake Pro                 | 09-11 | 1494cc | 420-888-996 | Mitsuba System | 248004 113.19 L |                |                    |
| XP                       | 92    | 581cc  | 278-000-186 | Denso System   | 248138 113.19 L | 248158 14.02 L | 248145 56.52 L     |
| XP                       | 93-94 | 650cc  | 278-000-316 | Denso System   | 248138 113.19 L | 248158 14.02 L | 248145 56.52 L     |
| XP                       | 95    | 718cc  | 278-000-485 | Denso System   | 248139 113.19 L |                | 248145 56.52 L     |
| XP                       | 95-96 | 782cc  | 278-000-577 | Denso System   | 248140 113.19 L | 248158 14.02 L | 248227 17.50 G     |
| XP                       | 97    | 782cc  | 278-001-038 | Denso System   | 248140 113.19 L | 248158 14.02 L | 248227 17.50 G     |
| XP                       | 98-02 | 951cc  | 278-000-987 | Mitsuba System | 248001 102.08 L |                | 249125 22.63 G     |
| XP DI                    | 03-04 | 951cc  | 278-001-937 | Mitsuba System | 248001 102.08 L |                | 249125 22.63 G     |

| <b>YAMAHA</b>         |       |        |                 |                |                 |  |                |
|-----------------------|-------|--------|-----------------|----------------|-----------------|--|----------------|
| FX700 FX1             | 94-95 | 701cc  | 6M6-81800-10-00 | Mitsuba System | 248002 113.19 L |  | 249125 22.63 G |
| FX1000 FX WaveRunner  | 02-08 | 998cc  | 60E-81800-00-00 | Mitsuba System | 248133 141.52 G |  |                |
| FX1100 FX WaveRunner  | 04-08 | 1100cc | 60E-81800-00-00 | Mitsuba System | 248133 141.52 G |  |                |
| FX1800 FX WaveRunner  | 08-14 | 1812cc | 6S5-81800-00-00 | Mitsuba System | 248137 204.16 G |  |                |
| GP760 WaveRunner      | 97-00 | 760cc  | 64X-81800-00-00 | Mitsuba System | 248136 130.41 L |  |                |
| GP800 WaveRunner      | 98-05 | 784cc  | 63M-81800-00-00 | Mitsuba System | 248003 113.19 L |  | 249125 22.63 G |
| GP1200 WaveRunner     | 97-02 | 1176cc | 63M-81800-00-00 | Mitsuba System | 248003 113.19 L |  | 249125 22.63 G |
| GP1300 WaveRunner     | 03-08 | 1300cc | 63M-81800-00-00 | Mitsuba System | 248003 113.19 L |  | 249125 22.63 G |
| GX1800 FZR WaveRunner | 09-13 | 1812cc | 6S5-81800-00-00 | Mitsuba System | 248137 204.16 G |  |                |
| GX1800 FZS WaveRunner | 09-13 | 1812cc | 6S5-81800-00-00 | Mitsuba System | 248137 204.16 G |  |                |
| RA700 Wave Raider     | 94-97 | 701cc  | 6M6-81800-10-00 | Mitsuba System | 248002 113.19 L |  | 249125 22.63 G |
| RA760 Wave Raider 760 | 96    | 760cc  | 64X-81800-00-00 | Mitsuba System | 248136 130.41 L |  |                |

## STARTERS • STARTER DRIVES & STARTER REBUILD KITS CONT'D

| MODEL                     | YEAR  | ENGINE | OEM #           | OPTIONS        | STARTER       |               | STARTER DRIVE | STARTER REPAIR KIT  |                     |   |
|---------------------------|-------|--------|-----------------|----------------|---------------|---------------|---------------|---------------------|---------------------|---|
| <b>YAMAHA CONTINUED</b>   |       |        |                 |                |               |               |               |                     |                     |   |
| RA1100 Wave Raider 1100   | 95-96 | 1100cc | 63M-81800-00-00 | Mitsuba System | <b>248003</b> | <b>113.19</b> | L             |                     | <b>249125 22.63</b> | G |
| SJ650 Super Jet           | 90-93 | 650cc  | 6M6-81800-10-00 | Mitsuba System | <b>248002</b> | <b>113.19</b> | L             |                     | <b>249125 22.63</b> | G |
| SJ700 Super Jet           | 94-14 | 701cc  | 6M6-81800-10-00 | Mitsuba System | <b>248002</b> | <b>113.19</b> | L             |                     | <b>249125 22.63</b> | G |
| SUV1200                   | 99-04 | 1176cc | 63M-81800-00-00 | Mitsuba System | <b>248003</b> | <b>113.19</b> | L             |                     | <b>249125 22.63</b> | G |
| VX1100 WaveRunner         | 05-14 | 1052cc | 6D3-81800-00-00 | Mitsuba System | <b>248135</b> | <b>141.52</b> | G             |                     | <b>249125 22.63</b> | G |
| VX1800 WaveRunner VXR     | 11-14 | 1812cc | 6S5-81800-00-00 | Mitsuba System | <b>248137</b> | <b>204.16</b> | G             |                     |                     |   |
| VX1800 WaveRunner VXS     | 11-14 | 1812cc | 6S5-81800-00-00 | Mitsuba System | <b>248137</b> | <b>204.16</b> | G             |                     |                     |   |
| WB700 Wave Blaster        | 93-96 | 701cc  | 6M6-81800-10-00 | Mitsuba System | <b>248002</b> | <b>113.19</b> | L             |                     | <b>249125 22.63</b> | G |
| WB760 Wave Blaster        | 96-97 | 760cc  | 64X-81800-00-00 | Mitsuba System | <b>248136</b> | <b>130.41</b> | L             |                     |                     |   |
| WJ500 Wave Jammer         | 87-91 | 500cc  | 6K8-81800-12-00 | Hitachi System | <b>248228</b> | <b>184.02</b> | G             | <b>248223 14.02</b> | G                   |   |
| WR500 WaveRunner          | 87    | 500cc  | 6K8-81800-12-00 | Hitachi System | <b>248228</b> | <b>184.02</b> | G             | <b>248223 14.02</b> | G                   |   |
| WR500 WaveRunner          | 89-93 | 500cc  | 6K8-81800-12-00 | Hitachi System | <b>248228</b> | <b>184.02</b> | G             | <b>248223 14.02</b> | G                   |   |
| WR650 WaveRunner LX       | 90-94 | 650cc  | 6M6-81800-10-00 | Mitsuba System | <b>248002</b> | <b>113.19</b> | L             |                     | <b>249125 22.63</b> | G |
| WRA650 WaveRunner III 650 | 90-96 | 650cc  | 6M6-81800-10-00 | Mitsuba System | <b>248002</b> | <b>113.19</b> | L             |                     | <b>249125 22.63</b> | G |
| WRA700 WaveRunner III 700 | 96-97 | 701cc  | 6M6-81800-10-00 | Mitsuba System | <b>248002</b> | <b>113.19</b> | L             |                     | <b>249125 22.63</b> | G |
| WRA700 WaveRunner III GP  | 94-95 | 701cc  | 6M6-81800-10-00 | Mitsuba System | <b>248002</b> | <b>113.19</b> | L             |                     | <b>249125 22.63</b> | G |
| WRB650 WaveRunner VXR     | 91-95 | 650cc  | 6M6-81800-10-00 | Mitsuba System | <b>248002</b> | <b>113.19</b> | L             |                     | <b>249125 22.63</b> | G |
| WRB700 WaveRunner Pro VXR | 93-94 | 701cc  | 6M6-81800-10-00 | Mitsuba System | <b>248002</b> | <b>113.19</b> | L             |                     | <b>249125 22.63</b> | G |
| WVT700 Wave Venture 700   | 95-98 | 701cc  | 6M6-81800-10-00 | Mitsuba System | <b>248002</b> | <b>113.19</b> | L             |                     | <b>249125 22.63</b> | G |
| WVT760 Wave Venture 760   | 97    | 760cc  | 64X-81800-00-00 | Mitsuba System | <b>248136</b> | <b>130.41</b> | L             |                     |                     |   |
| WVT1100 Wave Venture 1100 | 96-97 | 1100cc | 63M-81800-00-00 | Mitsuba System | <b>248003</b> | <b>113.19</b> | L             |                     | <b>249125 22.63</b> | G |
| XL700 WaveRunner          | 99-04 | 701cc  | 6M6-81800-10-00 | Mitsuba System | <b>248002</b> | <b>113.19</b> | L             |                     | <b>249125 22.63</b> | G |
| XL760 WaveRunner          | 98-99 | 760cc  | 64X-81800-00-00 | Mitsuba System | <b>248136</b> | <b>130.41</b> | L             |                     |                     |   |
| XL800 WaveRunner          | 00-01 | 784cc  | 63M-81800-00-00 | Mitsuba System | <b>248003</b> | <b>113.19</b> | L             |                     | <b>249125 22.63</b> | G |
| XL1200 WaveRunner         | 98-00 | 1176cc | 63M-81800-00-00 | Mitsuba System | <b>248003</b> | <b>113.19</b> | L             |                     | <b>249125 22.63</b> | G |
| XLT800 WaveRunner         | 02-04 | 784cc  | 63M-81800-00-00 | Mitsuba System | <b>248003</b> | <b>113.19</b> | L             |                     | <b>249125 22.63</b> | G |
| XLT1200 WaveRunner        | 01-05 | 1176cc | 63M-81800-00-00 | Mitsuba System | <b>248003</b> | <b>113.19</b> | L             |                     | <b>249125 22.63</b> | G |

- accessories
- towables
- body
- controls
- electrical
- driveline
- engine
- fuel & intake
- chemicals
- tie downs
- tools
- towing & loading

MARINE

# ELECTRICAL

## WILD BOAR OFF ROAD PRODUCTS

### REGULATORS & SOLENOIDS

- Meets or exceeds OEM specifications
- Heavy-duty connectors
- Runs cooler than OEM units
- New high performance MOSFET technology



| APPLICATION          | YEAR  | ENGINE | REGULATOR |       |   | SOLENOID |
|----------------------|-------|--------|-----------|-------|---|----------|
| <b>KAWASAKI</b>      |       |        |           |       |   |          |
| JF650 X2             | 88-91 | 650cc  | 248200    | 84.72 | G | ----     |
| JH750 750 SS         | 92-97 | 743cc  | 248201    | 62.22 | G | ----     |
| JH750 Super Sport XI | 93-97 | 743cc  | 248201    | 62.22 | G | ----     |
| JH750 Xi Sport       | 98-99 | 743cc  | 248201    | 62.22 | G | ----     |
| JH750 XiR            | 94    | 743cc  | 248201    | 62.22 | G | ----     |
| JS550 550 SX         | 92-95 | 550cc  | 248202    | 56.52 | G | ----     |
| JS650 650 SX         | 88-91 | 650cc  | 248200    | 84.72 | G | ----     |
| JS750 750 SX         | 92-95 | 743cc  | 248204    | 60.97 | G | ----     |
| JS750 750 Sxi        | 95-97 | 743cc  | 248204    | 60.97 | G | ----     |
| JS750 750 SXi Pro    | 98-02 | 743cc  | 248204    | 60.97 | G | ----     |
| JS800 SX-R           | 03-12 | 781cc  | 248204    | 60.97 | G | ----     |
| JT1200 STX-12F       | 04-07 | 1199cc | 248205    | 84.72 | G | ----     |
| JT1200 STX-R         | 02-05 | 1176cc | 248206    | 84.72 | G | ----     |
| JT1500 STX           | 09-10 | 1498cc | 248205    | 84.72 | G | ----     |
| JT1500 STX-15F       | 04-14 | 1498cc | 248205    | 84.72 | G | ----     |
| JT1500 Ultra 250X    | 07-09 | 1498cc | 248205    | 84.72 | G | ----     |
| JT1500 Ultra 260LX   | 09-10 | 1498cc | 248205    | 84.72 | G | ----     |
| JT1500 Ultra 260X    | 09-10 | 1498cc | 248205    | 84.72 | G | ----     |
| JT1500 Ultra 300LX   | 11-13 | 1498cc | 248205    | 84.72 | G | ----     |
| JT1500 Ultra 300X    | 11-13 | 1498cc | 248205    | 84.72 | G | ----     |
| JT1500 Ultra 310LX   | 14    | 1498cc | 248205    | 84.72 | G | ----     |
| JT1500 Ultra 310R    | 14    | 1498cc | 248205    | 84.72 | G | ----     |
| JT1500 Ultra 310X    | 14    | 1498cc | 248205    | 84.72 | G | ----     |
| JT1500 Ultra LX      | 07-14 | 1498cc | 248205    | 84.72 | G | ----     |
| JT750 750 STX        | 98    | 743cc  | 248201    | 62.22 | G | ----     |
| JT750 ST             | 94-95 | 743cc  | 248201    | 62.22 | G | ----     |
| JT750 STS            | 95-97 | 743cc  | 248201    |       |   | ----     |
| <b>POLARIS</b>       |       |        |           |       |   |          |
| Freedom              | 02-04 | 701cc  | 248207    | 73.61 | G | ----     |
| Genesis              | 00-02 | 1165cc | 248207    | 73.61 | G | ----     |
| Genesis              | 99    | 1165cc | 248208    | 65.13 | G | ----     |
| Hurricane            | 96-97 | 701cc  | 248208    | 65.13 | G | ----     |
| Octane               | 02-04 | 777cc  | 248209    | 72.09 | G | ----     |
| Pro 1200             | 00-01 | 1165cc | 248209    | 72.09 | G | ----     |
| Pro 785              | 00    | 779cc  | 248208    | 65.13 | G | ----     |
| SL 1050              | 97    | 1051cc | 248208    | 65.13 | G | ----     |
| SL 650               | 95    | 650cc  | 248208    | 65.13 | G | ----     |
| SL 750               | 94-95 | 750cc  | 248208    | 65.13 | G | ----     |
| SL 780               | 96-97 | 779cc  | 248208    | 65.13 | G | ----     |
| SL 900               | 96-97 | 900cc  | 248208    | 65.13 | G | ----     |
| SLH                  | 00-01 | 701cc  | 248208    | 65.13 | G | ----     |
| SLH                  | 98    | 701cc  | 248208    | 65.13 | G | ----     |
| SLT 780              | 96-97 | 779cc  | 248208    | 65.13 | G | ----     |
| SLTH                 | 98-99 | 701cc  | 248208    | 65.13 | G | ----     |
| SLTX                 | 96-99 | 1051cc | 248208    | 65.13 | G | ----     |
| SLX                  | 00-01 | 1165cc | 248208    | 65.13 | G | ----     |
| SLX 780              | 96    | 779cc  | 248208    | 65.13 | G | ----     |
| SLXH                 | 98    | 1051cc | 248208    | 65.13 | G | ----     |
| Virage               | 00-04 | 701cc  | 248207    | 73.61 | G | ----     |
| Virage TX            | 00-02 | 1165cc | 248207    | 73.61 | G | ----     |

- accessories
- towables
- body
- controls
- electrical
- driveline
- engine
- fuel & intake
- chemicals
- tie downs
- tools
- towing & loading

# MARINE

## WILDBOAR REGULATORS &amp; SOLENOIDS CONTINUED

| APPLICATION    | YEAR  | ENGINE | REGULATOR |        |   | SOLENOID |       |   |
|----------------|-------|--------|-----------|--------|---|----------|-------|---|
| <b>SEA-DOO</b> |       |        |           |        |   |          |       |   |
| 3D DI          | 04    | 782cc  | 248147    | 84.72  | L | 248224   | 22.63 | G |
| 3D DI          | 05    | 782cc  | 248148    | 110.41 | L | 248224   | 22.63 | G |
| 3D DI          | 06    | 951cc  | 248148    | 110.41 | L | 248224   | 22.63 | G |
| 3D DI          | 07    | 1494cc | -----     |        |   | 248224   | 22.63 | G |
| 3D DI          | 07    | 951cc  | 248148    | 110.41 | L | 248224   | 22.63 | G |
| GS             | 97-01 | 718cc  | 248150    | 39.58  | L | 248224   | 22.63 | G |
| GSI            | 97    | 718cc  | 248150    | 39.58  | L | 248224   | 22.63 | G |
| GSX            | 96    | 782cc  | 248151    | 59.44  | G | 248224   | 22.63 | G |
| GSX            | 97    | 782cc  | -----     |        |   | 248224   | 22.63 | G |
| GSX LTD        | 98-99 | 951cc  | -----     |        |   | 248224   | 22.63 | G |
| GSX RFI        | 00-01 | 782cc  | 248147    | 84.72  | L | 248224   | 22.63 | G |
| GSX RFI        | 99    | 782cc  | -----     |        |   | 248224   | 22.63 | G |
| GT             | 90-91 | 581cc  | -----     |        |   | 248224   | 22.63 | G |
| GTI            | 06-07 | 1494cc | 248148    | 110.41 | L | 248224   | 22.63 | G |
| GTI            | 08-12 | 1494cc | 248215    | 96.52  | G | 248224   | 22.63 | G |
| GTI            | 13    | 1494cc | 248215    | 96.52  | G | -----    |       |   |
| GTI            | 14    | 1503cc | 248215    | 96.52  | G | -----    |       |   |
| GTI            | 96    | 718cc  | 248149    | 39.58  | L | 248224   | 22.63 | G |
| GTI            | 96    | 718cc  | -----     |        |   | 248224   | 22.63 | G |
| GTI            | 97    | 718cc  | 248149    | 39.58  | L | 248224   | 22.63 | G |
| GTI            | 98-05 | 718cc  | 248150    | 39.58  | L | 248224   | 22.63 | G |
| GTI LE         | 02    | 718cc  | 248150    | 39.58  | L | 248224   | 22.63 | G |
| GTI LE         | 03-04 | 718cc  | 248147    | 84.72  | L | 248224   | 22.63 | G |
| GTI LE         | 05    | 782cc  | 248148    | 110.41 | L | 248224   | 22.63 | G |
| GTI LTD        | 11-12 | 1494cc | 248215    | 96.52  | G | 248224   | 22.63 | G |
| GTI LTD        | 13    | 1494cc | 248215    | 96.52  | G | -----    |       |   |
| GTI LTD        | 14    | 1503cc | 248215    | 96.52  | G | -----    |       |   |
| GTI RFI        | 03-04 | 782cc  | 248147    | 84.72  | L | 248224   | 22.63 | G |
| GTI RFI        | 05    | 782cc  | 248148    | 110.41 | L | 248224   | 22.63 | G |
| GTI SE         | 06-07 | 1494cc | 248148    | 110.41 | L | 248224   | 22.63 | G |
| GTI SE         | 08-12 | 1494cc | 248215    | 96.52  | G | 248224   | 22.63 | G |
| GTI SE         | 13    | 1494cc | 248215    | 96.52  | G | -----    |       |   |
| GTI SE         | 14    | 1503cc | 248215    | 96.52  | G | -----    |       |   |
| GTR            | 12    | 1494cc | 248215    | 96.52  | G | 248224   | 22.63 | G |
| GTR            | 13    | 1494cc | 248215    | 96.52  | G | -----    |       |   |
| GTR            | 14    | 1503cc | 248215    | 96.52  | G | -----    |       |   |
| GTS            | 11-12 | 1494cc | 248215    | 96.52  | G | 248224   | 22.63 | G |
| GTS            | 13    | 1494cc | 248215    | 96.52  | G | -----    |       |   |
| GTS            | 14    | 1503cc | 248215    | 96.52  | G | -----    |       |   |
| GTS            | 92-94 | 581cc  | -----     |        |   | 248224   | 22.63 | G |
| GTS            | 95    | 581cc  | -----     |        |   | 248224   | 22.63 | G |
| GTS            | 95    | 581cc  | -----     |        |   | 248224   | 22.63 | G |
| GTS            | 96    | 581cc  | 248149    | 39.58  | L | 248224   | 22.63 | G |
| GTS            | 97-01 | 718cc  | 248149    | 39.58  | L | 248224   | 22.63 | G |
| GTS Pro        | 11    | 1494cc | 248215    | 96.52  | G | 248224   | 22.63 | G |
| GTX            | 07    | 1494cc | -----     |        |   | 248224   | 22.63 | G |
| GTX            | 08-12 | 1494cc | 248215    | 96.52  | G | 248224   | 22.63 | G |
| GTX            | 13    | 1494cc | 248215    | 96.52  | G | -----    |       |   |
| GTX            | 14    | 1503cc | 248215    | 96.52  | G | -----    |       |   |
| GTX            | 92    | 581cc  | -----     |        |   | 248224   | 22.63 | G |
| GTX            | 93-94 | 650cc  | -----     |        |   | 248224   | 22.63 | G |
| GTX            | 95    | 650cc  | -----     |        |   | 248224   | 22.63 | G |
| GTX            | 95    | 650cc  | -----     |        |   | 248224   | 22.63 | G |
| GTX            | 96-97 | 782cc  | 248151    | 59.44  | G | 248224   | 22.63 | G |
| GTX            | 98-02 | 951cc  | -----     |        |   | 248224   | 22.63 | G |
| GTX 4-TEC      | 02-07 | 1494cc | 248148    | 110.41 | L | 248224   | 22.63 | G |
| GTX 4-TEC      | 08    | 1494cc | -----     |        |   | 248224   | 22.63 | G |
| GTX DI         | 00-03 | 951cc  | 248147    | 84.72  | L | 248224   | 22.63 | G |
| GTX iS         | 09-11 | 1494cc | 248215    | 96.52  | G | 248224   | 22.63 | G |
| GTX LTD        | 07    | 1494cc | -----     |        |   | 248224   | 22.63 | G |
| GTX LTD        | 08    | 1494cc | 248215    | 96.52  | G | 248224   | 22.63 | G |
| GTX LTD iS     | 09-12 | 1494cc | 248215    | 96.52  | G | 248224   | 22.63 | G |

accessories

towables

body

controls

electrical

driveline

engine

fuel &amp; intake

chemicals

tie downs

tools

towing &amp; loading

MARINE

## WILDBOAR REGULATORS & SOLENOIDS CONTINUED

| APPLICATION              | YEAR  | ENGINE | REGULATOR |        |   | SOLENOID |       |   |
|--------------------------|-------|--------|-----------|--------|---|----------|-------|---|
| <b>SEA-DOO CONTINUED</b> |       |        |           |        |   |          |       |   |
| GTX LTD iS               | 13    | 1494cc | 248215    | 96.52  | G | -----    |       |   |
| GTX LTD iS               | 14    | 1503cc | 248215    | 96.52  | G | -----    |       |   |
| GTX RFI                  | 98    | 782cc  | 248147    | 84.72  | L | 248224   | 22.63 | G |
| GTX RFI                  | 99-02 | 782cc  | 248147    | 84.72  | L | 248224   | 22.63 | G |
| GTX S                    | 12    | 1494cc | 248215    | 96.52  | G | 248224   | 22.63 | G |
| GTX S                    | 13-14 | 1494cc | 248215    | 96.52  | G | -----    |       |   |
| GTX Wake                 | 05-07 | 1494cc | 248148    | 110.41 | L | 248224   | 22.63 | G |
| HX                       | 95    | 718cc  | -----     |        |   | 248224   | 22.63 | G |
| HX                       | 96-97 | 718cc  | 248149    | 39.58  | L | 248224   | 22.63 | G |
| LRV                      | 00-01 | 951cc  | -----     |        |   | 248224   | 22.63 | G |
| LRV DI                   | 02-03 | 951cc  | 248147    | 84.72  | L | 248224   | 22.63 | G |
| RX                       | 00-02 | 951cc  | -----     |        |   | 248224   | 22.63 | G |
| RX DI                    | 00-03 | 951cc  | 248147    | 84.72  | L | 248224   | 22.63 | G |
| RX X                     | 01    | 951cc  | -----     |        |   | 248224   | 22.63 | G |
| RXP                      | 04-07 | 1494cc | 248148    | 110.41 | L | 248224   | 22.63 | G |
| RXP                      | 08-09 | 1494cc | 248215    | 96.52  | G | 248224   | 22.63 | G |
| RXP X                    | 08-12 | 1494cc | 248215    | 96.52  | G | 248224   | 22.63 | G |
| RXP X                    | 13    | 1494cc | 248215    | 96.52  | G | -----    |       |   |
| RXP X                    | 14    | 1503cc | 248215    | 96.52  | G | -----    |       |   |
| RXT                      | 05-07 | 1494cc | 248148    | 110.41 | L | 248224   | 22.63 | G |
| RXT                      | 08-12 | 1494cc | 248215    | 96.52  | G | 248224   | 22.63 | G |
| RXT                      | 13    | 1494cc | 248215    | 96.52  | G | -----    |       |   |
| RXT                      | 14    | 1503cc | 248215    | 96.52  | G | -----    |       |   |
| RXT iS                   | 09-11 | 1494cc | 248215    | 96.52  | G | 248224   | 22.63 | G |
| RXT X                    | 09-12 | 1494cc | 248215    | 96.52  | G | 248224   | 22.63 | G |
| RXT X                    | 13    | 1494cc | 248215    | 96.52  | G | -----    |       |   |
| RXT X                    | 14    | 1503cc | 248215    | 96.52  | G | -----    |       |   |
| RXT X aS                 | 11-12 | 1494cc | 248215    | 96.52  | G | 248224   | 22.63 | G |
| RXT X aS                 | 13    | 1494cc | 248215    | 96.52  | G | -----    |       |   |
| RXT X aS                 | 14    | 1503cc | 248215    | 96.52  | G | -----    |       |   |
| SP                       | 89-91 | 581cc  | -----     |        |   | 248224   | 22.63 | G |
| SP                       | 92-94 | 581cc  | -----     |        |   | 248224   | 22.63 | G |
| SP                       | 95    | 581cc  | -----     |        |   | 248224   | 22.63 | G |
| SP                       | 96    | 581cc  | 248149    | 39.58  | L | 248224   | 22.63 | G |
| SP                       | 97    | 718cc  | 248149    | 39.58  | L | 248224   | 22.63 | G |
| Spark                    | 14    | 903cc  | 248215    | 96.52  | G | -----    |       |   |
| SPI                      | 93-94 | 581cc  | -----     |        |   | 248224   | 22.63 | G |
| SPI                      | 95    | 581cc  | -----     |        |   | 248224   | 22.63 | G |
| SPI                      | 96    | 581cc  | 248149    | 39.58  | L | 248224   | 22.63 | G |
| SPX                      | 93    | 581cc  | -----     |        |   | 248224   | 22.63 | G |
| SPX                      | 94    | 650cc  | -----     |        |   | 248224   | 22.63 | G |
| SPX                      | 95    | 650cc  | -----     |        |   | 248224   | 22.63 | G |
| SPX                      | 96    | 718cc  | 248149    | 39.58  | L | 248224   | 22.63 | G |
| SPX                      | 97    | 782cc  | 248151    | 59.44  | G | 248224   | 22.63 | G |
| SPX                      | 98-99 | 782cc  | 248151    | 59.44  | G | 248224   | 22.63 | G |
| Wake                     | 08-12 | 1494cc | 248215    | 96.52  | G | 248224   | 22.63 | G |
| Wake                     | 13    | 1494cc | 248215    | 96.52  | G | -----    |       |   |
| Wake                     | 14    | 1503cc | 248215    | 96.52  | G | -----    |       |   |
| Wake Pro                 | 09-12 | 1494cc | 248215    | 96.52  | G | 248224   | 22.63 | G |
| Wake Pro                 | 13    | 1494cc | 248215    | 96.52  | G | -----    |       |   |
| Wake Pro                 | 14    | 1503cc | 248215    | 96.52  | G | -----    |       |   |
| XP                       | 91    | 581cc  | -----     |        |   | 248224   | 22.63 | G |
| XP                       | 92    | 581cc  | -----     |        |   | 248224   | 22.63 | G |
| XP                       | 93-94 | 650cc  | -----     |        |   | 248224   | 22.63 | G |
| XP                       | 95    | 718cc  | -----     |        |   | 248224   | 22.63 | G |
| XP                       | 95    | 782cc  | -----     |        |   | 248224   | 22.63 | G |
| XP                       | 96    | 782cc  | 248151    | 59.44  | G | 248224   | 22.63 | G |
| XP                       | 97    | 782cc  | 248216    | 53.75  | G | 248224   | 22.63 | G |
| XP                       | 98-02 | 951cc  | -----     |        |   | 248224   | 22.63 | G |
| XP DI                    | 03-04 | 951cc  | 248147    | 84.72  | L | 248224   | 22.63 | G |

- accessories
- towables
- body
- controls
- electrical
- driveline
- engine
- fuel & intake
- chemicals
- tie downs
- tools
- towing & loading

MARINE



## WILDBOAR REGULATORS &amp; SOLENOIDS CONTINUED

| APPLICATION               | YEAR  | ENGINE | REGULATOR |       |   | SOLENOID |       |   |
|---------------------------|-------|--------|-----------|-------|---|----------|-------|---|
| <b>YAMAHA</b>             |       |        |           |       |   |          |       |   |
| FX1000 FX WaveRunner      | 02-04 | 998cc  | -----     |       |   | 248225   | 22.63 | G |
| FX1000 FX WaveRunner      | 07-08 | 998cc  | 248219    | 83.19 | G | -----    |       |   |
| FX700 FX1                 | 94-95 | 701cc  | 248217    | 50.97 | G | 248226   | 16.94 | G |
| GP1200 WaveRunner         | 00-01 | 1176cc | 248218    | 62.22 | G | 248226   | 16.94 | G |
| GP1200 WaveRunner         | 02    | 1176cc | 248218    | 62.22 | G | 248225   | 22.63 | G |
| GP1200 WaveRunner         | 97-99 | 1176cc | 248153    | 53.75 | G | 248226   | 16.94 | G |
| GP1300 WaveRunner         | 03-06 | 1300cc | -----     |       |   | 248225   | 22.63 | G |
| GP1300 WaveRunner         | 07-08 | 1300cc | 248219    | 83.19 | G | 248225   | 22.63 | G |
| GP760 WaveRunner          | 97-00 | 760cc  | 248217    | 50.97 | G | 248226   | 16.94 | G |
| GP800 WaveRunner          | 02-05 | 784cc  | 248152    | 50.97 | G | 248225   | 22.63 | G |
| GP800 WaveRunner          | 98-01 | 784cc  | 248152    | 50.97 | G | 248226   | 16.94 | G |
| RA1100 Wave Raider 1100   | 95-96 | 1100cc | 248152    | 50.97 | G | 248226   | 16.94 | G |
| RA700 Wave Raider         | 94-97 | 701cc  | 248217    | 50.97 | G | 248226   | 16.94 | G |
| RA760 Wave Raider 760     | 96    | 760cc  | 248217    | 50.97 | G | 248226   | 16.94 | G |
| SJ650 Super Jet           | 90-93 | 650cc  | 248217    | 50.97 | G | 248226   | 16.94 | G |
| SJ700 Super Jet           | 02-11 | 701cc  | 248217    | 50.97 | G | 248225   | 22.63 | G |
| SJ700 Super Jet           | 12-13 | 701cc  | 248217    | 50.97 | G | 248225   | 22.63 | G |
| SJ700 Super Jet           | 14    | 701cc  | 248217    | 50.97 | G | -----    |       |   |
| SJ700 Super Jet           | 94-95 | 701cc  | 248217    | 50.97 | G | 248226   | 16.94 | G |
| SJ700 Super Jet           | 96-01 | 701cc  | 248217    | 50.97 | G | 248226   | 16.94 | G |
| SUV1200                   | 02-04 | 1176cc | 248153    | 53.75 | G | 248225   | 22.63 | G |
| SUV1200                   | 99-01 | 1176cc | 248153    | 53.75 | G | 248226   | 16.94 | G |
| VX1100 WaveRunner         | 09    | 1052cc | 248219    | 83.19 | G | -----    |       |   |
| WB700 Wave Blaster        | 93-95 | 701cc  | 248217    | 50.97 | G | 248226   | 16.94 | G |
| WB700 Wave Blaster        | 96    | 701cc  | 248217    | 50.97 | G | 248226   | 16.94 | G |
| WB760 Wave Blaster        | 96-97 | 760cc  | 248217    | 50.97 | G | 248226   | 16.94 | G |
| WJ500 Wave Jammer         | 87-90 | 500cc  | 248220    | 53.75 | G | 248226   | 16.94 | G |
| WJ500 Wave Jammer         | 91    | 500cc  | -----     |       |   | 248226   | 16.94 | G |
| WR500 WaveRunner          | 87-93 | 500cc  | 248220    | 53.75 | G | 248226   | 16.94 | G |
| WR650 WaveRunner LX       | 90-94 | 650cc  | 248217    | 50.97 | G | 248226   | 16.94 | G |
| WRA650 WaveRunner III 650 | 90-95 | 650cc  | 248217    | 50.97 | G | 248226   | 16.94 | G |
| WRA650 WaveRunner III 650 | 96    | 650cc  | 248217    | 50.97 | G | 248226   | 16.94 | G |
| WRA700 WaveRunner III 700 | 96-97 | 701cc  | 248217    | 50.97 | G | 248226   | 16.94 | G |
| WRA700 WaveRunner III GP  | 94-95 | 701cc  | 248217    | 50.97 | G | 248226   | 16.94 | G |
| WRB650 WaveRunner VXR     | 91-95 | 650cc  | 248217    | 50.97 | G | 248226   | 16.94 | G |
| WRB700 WaveRunner Pro VXR | 93-94 | 701cc  | 248217    | 50.97 | G | 248226   | 16.94 | G |
| WVT1100 Wave Venture 1100 | 96-97 | 1100cc | 248152    | 50.97 | G | 248226   | 16.94 | G |
| WVT700 Wave Venture 700   | 95-98 | 701cc  | 248217    | 50.97 | G | 248226   | 16.94 | G |
| WVT760 Wave Venture 760   | 97    | 760cc  | 248217    | 50.97 | G | 248226   | 16.94 | G |
| XL1200 WaveRunner         | 98    | 1176cc | 248153    | 53.75 | G | 248226   | 16.94 | G |
| XL1200 WaveRunner         | 99-00 | 1176cc | 248218    | 62.22 | G | 248226   | 16.94 | G |
| XL700 WaveRunner          | 02-04 | 701cc  | 248217    | 50.97 | G | 248225   | 22.63 | G |
| XL700 WaveRunner          | 99-01 | 701cc  | 248217    | 50.97 | G | 248226   | 16.94 | G |
| XL760 WaveRunner          | 98-99 | 760cc  | 248217    | 50.97 | G | 248226   | 16.94 | G |
| XL800 WaveRunner          | 00-01 | 784cc  | 248152    | 50.97 | G | 248226   | 16.94 | G |
| XLT1200 WaveRunner        | 01    | 1176cc | 248218    | 62.22 | G | 248226   | 16.94 | G |
| XLT1200 WaveRunner        | 02-05 | 1176cc | 248218    | 62.22 | G | 248225   | 22.63 | G |
| XLT800 WaveRunner         | 02-04 | 784cc  | 248152    | 50.97 | G | 248225   | 22.63 | G |

accessories

towables

body

controls

electrical

driveline

engine

fuel &amp; intake

chemicals

tie downs

tools

towing &amp; loading

MARINE



## STARTER RELAYS

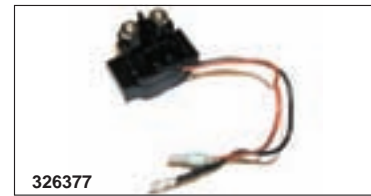

| MAKE/MODEL           | YEAR  | OEM #                     | PART #        |                 |
|----------------------|-------|---------------------------|---------------|-----------------|
| <b>KAWASAKI</b>      |       |                           |               |                 |
| 550                  | 92-95 | 27010-3760                | <b>326381</b> | <b>33.32</b> L  |
| 650 SX               | 87-91 | 27010-3705                | <b>326379</b> | <b>33.32</b> L  |
| 650 X2               | 91    | 27010-3705                | <b>326379</b> | <b>33.32</b> L  |
| 750 SXi Pro          | 99-02 | 27010-3760                | <b>326381</b> | <b>33.32</b> L  |
| 750 Xi Sport         | 98-99 | 27010-3760                | <b>326381</b> | <b>33.32</b> L  |
| 750 ZXi              | 95-97 | 27010-3737                | <b>326380</b> | <b>66.75</b> L  |
| 800 SX-R             | 03-06 | 27010-3760                | <b>326381</b> | <b>33.32</b> L  |
| 900 STS              | 01-02 | 27010-3760                | <b>326381</b> | <b>33.32</b> L  |
| 900 STX              | 97-98 | 27010-3737                | <b>326380</b> | <b>66.75</b> L  |
| 900 STX              | 99-06 | 27010-3760                | <b>326381</b> | <b>33.32</b> L  |
| 900 ZXi              | 95-97 | 27010-3737                | <b>326380</b> | <b>66.75</b> L  |
| 1100 STX             | 97-98 | 27010-3737                | <b>326380</b> | <b>66.75</b> L  |
| 1100 STX             | 99    | 27010-3760                | <b>326381</b> | <b>33.32</b> L  |
| 1100 ZXi             | 96-03 | 27010-3737                | <b>326380</b> | <b>66.75</b> L  |
| 1200 ULTRA 150       | 99-05 | 27010-3757                | <b>329237</b> | <b>53.49</b> L  |
| 1200 STX-12F         | 03-07 | 27002-3703/<br>27002-3702 | <b>329236</b> | <b>33.32</b> L  |
| 1500 STX             | 09-10 | 27002-3703/<br>27002-3702 | <b>328236</b> | <b>208.80</b> L |
| 1500 STX-15F         | 04-15 | 27002-3703/<br>27002-3702 | <b>327236</b> | <b>18.35</b> L  |
| 1500 Ultra 250X      | 08    | 27002-3703/<br>27002-3702 | <b>326236</b> | <b>220.40</b> L |
| 1500 Ultra 260 LX    | 09    | 27002-3703/<br>27002-3702 | <b>325236</b> | <b>TBA</b>      |
| 1500 Ultra 260 LX SC | 10    | 27002-3703/<br>27002-3702 | <b>324236</b> | <b>TBA</b>      |
| 1500 Ultra 260 X     | 09    | 27002-3703/<br>27002-3702 | <b>323236</b> | <b>TBA</b>      |
| 1500 Ultra 260 X SC  | 10    | 27002-3703/<br>27002-3702 | <b>322236</b> | <b>TBA</b>      |
| 1500 Ultra 300 LX    | 11-13 | 27002-3703/<br>27002-3702 | <b>321236</b> | <b>TBA</b>      |
| 1500 Ultra 300 X     | 11-13 | 27002-3703/<br>27002-3702 | <b>320236</b> | <b>TBA</b>      |
| 1500 Ultra LX        | 07-13 | 27002-3703/<br>27002-3702 | <b>319236</b> | <b>TBA</b>      |
| 1500 Ultra 310 X     | 14-15 | 27002-3703/<br>27002-3702 | <b>318236</b> | <b>TBA</b>      |
| 1500 Ultra 310 LX    | 14-15 | 27002-3703/<br>27002-3702 | <b>317236</b> | <b>TBA</b>      |
| 1500 Ultra 310 R     | 14-15 | 27002-3703/<br>27002-3702 | <b>316236</b> | <b>TBA</b>      |
| 1500 Ultra 310X SE   | 14-15 | 27002-3703/<br>27002-3702 | <b>315236</b> | <b>TBA</b>      |

| MAKE/MODEL                         | YEAR   | OEM #        | PART #        |                |
|------------------------------------|--------|--------------|---------------|----------------|
| <b>SEA-DOO</b>                     |        |              |               |                |
| All Models W/O Update Kit          | 88-94  | 278000342    | <b>326374</b> | <b>21.65</b> L |
| All RFI and DI Models              | All    | 278000513    | <b>326375</b> | <b>30.00</b> L |
| All 2-Stroke Exc. RFI&DI Models    | 95-Up  | 278001802    | <b>329035</b> | <b>29.98</b> L |
| All 4-Stroke Models External Mount | All    | 278002347    | <b>329035</b> | <b>29.98</b> L |
| <b>YAMAHA</b>                      |        |              |               |                |
| All                                | 87-01  | 6G1-81941-10 | <b>326376</b> | <b>38.35</b> L |
| SJ 700                             | 02-15  | 68N-81940-00 | <b>326377</b> | <b>38.35</b> L |
| XL 700                             | 02-04  | 68N-81940-00 | <b>326377</b> | <b>38.35</b> L |
| GP 800                             | 02-05  | 68N-81940-00 | <b>326377</b> | <b>38.35</b> L |
| XLT 800                            | 02-04  | 68N-81940-00 | <b>326377</b> | <b>38.35</b> L |
| GP 1200                            | 02     | 68N-81940-00 | <b>326377</b> | <b>38.35</b> L |
| SUV 1200                           | 03     | 68N-81940-00 | <b>326377</b> | <b>38.35</b> L |
| SV 1200                            | 02, 04 | 68N-81940-00 | <b>326377</b> | <b>38.35</b> L |
| XLT 1200                           | 02-05  | 68N-81940-00 | <b>326377</b> | <b>38.35</b> L |
| GP 1300                            | 03-08  | 68N-81940-00 | <b>326377</b> | <b>38.35</b> L |
| FX 1000                            | 04     | 68N-81940-00 | <b>326377</b> | <b>38.35</b> L |
| FX 140                             | 02-04  | 68N-81940-00 | <b>326377</b> | <b>38.35</b> L |
| FX Cruiser                         | 03     | 68N-81940-00 | <b>326377</b> | <b>38.35</b> L |
| FX 1100                            | 04-08  | 6B6-81940-00 | <b>326378</b> | <b>58.40</b> L |
| FX HO                              | 05-08  | 6B6-81940-00 | <b>326378</b> | <b>58.40</b> L |
| VX 1100                            | 05-15  | 6B6-81940-00 | <b>326378</b> | <b>58.40</b> L |
| 1100 V1/V1 SPORT                   | 15     | 6B6-81940-00 |               |                |

- accessories
- towables
- body
- controls
- electrical
- driveline
- engine
- fuel & intake
- chemicals
- tie downs
- tools
- towing & loading

MARINE



## COILS / ARMATURE

OEM QUALITY REPLACEMENT PARTS  
AT A LOW PRICE



| MODEL           | CC   | YEAR  | OEM #      | DESCRIPTION   | PART # |        |   |
|-----------------|------|-------|------------|---------------|--------|--------|---|
| <b>KAWASAKI</b> |      |       |            |               |        |        |   |
| JS              | 440  | 76-80 | 21121-518  | Ignition Coil | 326411 | 79.95  | L |
| SX              | 650  | 87-91 | 21119-3703 | Ignition Coil | 326428 | 165.99 | L |
| SX              | 750  | 92-95 | 21121-3702 | Ignition Coil | 326410 | 64.95  | L |
| SXI             | 750  | 95-02 | 21121-3705 | Ignition Coil | 326410 | 64.95  | L |
| STS             | 900  | 01-02 | 21121-3708 | Ignition Coil | 326414 | 50.05  | L |
| STX             | 900  | 97-06 | 21121-3708 | Ignition Coil | 326414 | 50.05  | L |
| ZXI             | 900  | 95-97 | 21121-3708 | Ignition Coil | 326414 | 50.05  | L |
| STX             | 1100 | 97-99 | 21121-3708 | Ignition Coil | 326414 | 50.05  | L |
| ZXI             | 1100 | 96-03 | 21121-3708 | Ignition Coil | 326414 | 50.05  | L |
| STS             | 900  | 01-02 | 21121-3709 | Ignition Coil | 326415 | 50.05  | L |
| STX             | 900  | 97-06 | 21121-3709 | Ignition Coil | 326415 | 50.05  | L |
| ZXI             | 900  | 95-97 | 21121-3709 | Ignition Coil | 326415 | 50.05  | L |
| STX             | 1100 | 97-99 | 21121-3709 | Ignition Coil | 326415 | 50.05  | L |
| ZXI             | 1100 | 96-03 | 21121-3709 | Ignition Coil | 326415 | 50.05  | L |
| STS             | 900  | 01-02 | 21121-3710 | Ignition Coil | 326416 | 50.05  | L |
| STX             | 900  | 97-06 | 21121-3710 | Ignition Coil | 326416 | 50.05  | L |
| ZXI             | 900  | 95-97 | 21121-3710 | Ignition Coil | 326416 | 50.05  | L |
| STX             | 1100 | 97-99 | 21121-3710 | Ignition Coil | 326416 | 50.05  | L |
| ZXI             | 1100 | 96-03 | 21121-3710 | Ignition Coil | 326416 | 50.05  | L |
| JS              | 440  | 79-82 | 59031-3001 | Charge Coil   | 326394 | 36.85  | L |
| JS              | 440  | 83-92 | 59031-3002 | Charge Coil   | 326397 | 38.15  | L |
| JS              | 550  | 82-89 | 59031-3002 | Charge Coil   | 326397 | 38.15  | L |
| SX              | 550  | 90-95 | 59031-3002 | Charge Coil   | 326397 | 38.15  | L |
| SC              | 650  | 91-95 | 21003-3719 | Charge Coil   | 326400 | 42.15  | L |
| TS              | 650  | 89-90 | 21003-3712 | Charge Coil   | 326400 | 42.15  | L |
| JS              | 440  | 79-82 | 21049-3006 | Exciter Coil  | 326395 | 34.25  | L |
| JS              | 440  | 83-92 | 21049-3007 | Exciter Coil  | 326398 | 33.05  | L |
| JS              | 550  | 82-89 | 21049-3007 | Exciter Coil  | 326398 | 33.05  | L |
| SX              | 550  | 90-95 | 21049-3007 | Exciter Coil  | 326398 | 33.05  | L |
| SC              | 650  | 91-95 | 21003-3719 | Exciter Coil  | 326401 | 42.15  | L |
| TS              | 650  | 89-90 | 21003-3712 | Exciter Coil  | 326401 | 42.15  | L |
| JS              | 440  | 83-92 | 59026-3008 | Pulser Coil   | 326399 | 33.05  | L |
| JS              | 550  | 82-89 | 59026-3008 | Pulser Coil   | 326399 | 33.05  | L |
| SX              | 550  | 90-95 | 59026-3008 | Pulser Coil   | 326399 | 33.05  | L |
| STX-12F         | 1200 | 2003  | 21003-3747 | Armature Coil | 329258 | 234.95 | L |
| ULTRA 250x      | 1500 | 07-08 | 21003-3747 | Armature Coil | 329258 | 234.95 | L |
| ULTRA 260X / LX | 1500 | 09-10 | 21003-3747 | Armature Coil | 329258 | 234.95 | L |
| ULTRA 300X / LX | 1500 | 11-13 | 21003-3747 | Armature Coil | 329258 | 234.95 | L |

- accessories
- towables
- body
- controls
- electrical
- driveline
- engine
- fuel & intake
- chemicals
- tie downs
- tools
- towing & loading

# MARINE

## COILS / ARMATURE CONTINUED

| MODEL                     | CC   | YEAR  | OEM #       | DESCRIPTION   | PART #        |               |   |
|---------------------------|------|-------|-------------|---------------|---------------|---------------|---|
| <b>KAWASAKI CONTINUED</b> |      |       |             |               |               |               |   |
| ULTRA 310X / LX           | 1500 | 14-15 | 21003-3747  | Armature Coil | <b>329258</b> | <b>234.95</b> | L |
| ULTRA 310R / SE           | 1500 | 14-15 | 21003-3747  | Armature Coil | <b>329258</b> | <b>234.95</b> | L |
| <b>POLARIS</b>            |      |       |             |               |               |               |   |
| SL                        | 650  | 92-95 | 3240107     | Ignition Coil | <b>326412</b> | <b>35.15</b>  | L |
| SL                        | 750  | 93-95 | 3240107     | Ignition Coil | <b>326412</b> | <b>35.15</b>  | L |
| SLT                       | 750  | 94-95 | 3240107     | Ignition Coil | <b>326412</b> | <b>35.15</b>  | L |
| SL                        | 780  | 96-97 | 3240107     | Ignition Coil | <b>326412</b> | <b>35.15</b>  | L |
| SLT                       | 780  | 96    | 3240107     | Ignition Coil | <b>326412</b> | <b>35.15</b>  | L |
| SLX                       | 780  | 95-96 | 3240107     | Ignition Coil | <b>326412</b> | <b>35.15</b>  | L |
| <b>SEA-DOO</b>            |      |       |             |               |               |               |   |
| 3D DI                     |      | 06-07 | 278001451   | Ignition Coil | <b>329241</b> | <b>62.73</b>  | L |
| GTX DI                    |      | 00-03 | 278001451   | Ignition Coil | <b>329241</b> | <b>62.73</b>  | L |
| LRC DI                    |      | 02    | 278001451   | Ignition Coil | <b>329241</b> | <b>62.73</b>  | L |
| RX DI                     |      | 00-03 | 278001451   | Ignition Coil | <b>329241</b> | <b>62.73</b>  | L |
| XP DI                     |      | 03-04 | 278001451   | Ignition Coil | <b>329241</b> | <b>62.73</b>  | L |
| SP                        | 580  | 89-90 | 290-866-607 | Ignition Coil | ----          |               |   |
| GTS                       | 580  | 92-96 | 278-000-202 | Ignition Coil | <b>326408</b> | <b>84.35</b>  | L |
| GTX                       | 580  | 92-93 | 278-000-586 | Ignition Coil | <b>326408</b> | <b>84.35</b>  | L |
| SP                        | 580  | 92-96 | 278-000-586 | Ignition Coil | <b>326408</b> | <b>84.35</b>  | L |
| SPI                       | 580  | 93-96 | 278-000-586 | Ignition Coil | <b>326408</b> | <b>84.35</b>  | L |
| XP                        | 580  | 92    | 278-000-586 | Ignition Coil | <b>326408</b> | <b>84.35</b>  | L |
| GTX                       | 650  | 94-95 | 278-000-586 | Ignition Coil | <b>326408</b> | <b>84.35</b>  | L |
| SPX                       | 650  | 93-95 | 278-000-586 | Ignition Coil | <b>326408</b> | <b>84.35</b>  | L |
| XP                        | 650  | 94-95 | 278-000-586 | Ignition Coil | <b>326408</b> | <b>84.35</b>  | L |
| XPI                       | 650  | 94    | 278-000-586 | Ignition Coil | <b>326408</b> | <b>84.35</b>  | L |
| GTI                       | 720  | 96-97 | 278-000-586 | Ignition Coil | <b>326408</b> | <b>84.35</b>  | L |
| GTS                       | 720  | 97-00 | 278-000-586 | Ignition Coil | <b>326408</b> | <b>84.35</b>  | L |
| HX                        | 720  | 95-97 | 278-000-586 | Ignition Coil | <b>326408</b> | <b>84.35</b>  | L |
| SP                        | 720  | 97    | 278-000-586 | Ignition Coil | <b>326408</b> | <b>84.35</b>  | L |
| SPX                       | 720  | 96-97 | 278-000-586 | Ignition Coil | <b>326408</b> | <b>84.35</b>  | L |
| GTI                       | 720  | 01-05 | 278-000-383 | Ignition Coil | <b>326407</b> | <b>66.75</b>  | L |
| GTI LE                    | 720  | 02-04 | 278-000-383 | Ignition Coil | <b>326407</b> | <b>66.75</b>  | L |
| GTS                       | 720  | 01    | 278-000-383 | Ignition Coil | <b>326407</b> | <b>66.75</b>  | L |
| SP                        | 720  | 97    | 278-000-383 | Ignition Coil | <b>326407</b> | <b>66.75</b>  | L |
| GSX                       | 800  | 96-97 | 278-000-383 | Ignition Coil | <b>326407</b> | <b>66.75</b>  | L |
| GTX                       | 800  | 96-97 | 278-000-383 | Ignition Coil | <b>326407</b> | <b>66.75</b>  | L |
| SPX                       | 800  | 97-99 | 278-000-383 | Ignition Coil | <b>326407</b> | <b>66.75</b>  | L |
| XP                        | 800  | 95-96 | 278-000-383 | Ignition Coil | <b>326407</b> | <b>66.75</b>  | L |
| GTX LTD                   | 951  | 98    | 278-000-383 | Ignition Coil | <b>326407</b> | <b>66.75</b>  | L |
| All GTI                   | 1503 | 06-14 | 420-664-020 | Ignition Coil | <b>326404</b> | <b>83.45</b>  | L |
| All GTX                   | 1503 | 03-14 | 290-664-020 | Ignition Coil | <b>326404</b> | <b>83.45</b>  | L |
| RXP                       | 1503 | 04-09 | 290-664-020 | Ignition Coil | <b>326404</b> | <b>83.45</b>  | L |
| RXT                       | 1503 | 05-09 | 290-664-020 | Ignition Coil | <b>326404</b> | <b>83.45</b>  | L |
| WAKE 155, 215, 255        | 1503 | 08-14 | 290-664-020 | Ignition Coil | <b>326404</b> | <b>83.45</b>  | L |
| All GTI                   | 1503 | 07-14 | 420-460-830 | Rubber Boot   | <b>326405</b> | <b>11.65</b>  | L |
| All GTX                   | 1503 | 07-14 | 420-460-830 | Rubber Boot   | <b>326405</b> | <b>11.65</b>  | L |
| RXP 115,                  | 1503 | 07-09 | 420-460-830 | Rubber Boot   | <b>326405</b> | <b>11.65</b>  | L |
| RXP 215                   | 1503 | 07-09 | 420-460-830 | Rubber Boot   | <b>326405</b> | <b>11.65</b>  | L |
| RXP 225                   | 1503 | 07-09 | 420-460-830 | Rubber Boot   | <b>326405</b> | <b>11.65</b>  | L |
| RXT 215,                  | 1503 | 07-09 | 420-460-830 | Rubber Boot   | <b>326405</b> | <b>11.65</b>  | L |
| RXT 255                   | 1503 | 07-09 | 420-460-830 | Rubber Boot   | <b>326405</b> | <b>11.65</b>  | L |
| WAKE 155                  | 1503 | 08-14 | 420-460-830 | Rubber Boot   | <b>326405</b> | <b>11.65</b>  | L |
| WAKE 215                  | 1503 | 08-14 | 420-460-830 | Rubber Boot   | <b>326405</b> | <b>11.65</b>  | L |
| GT                        | 580  | 90-91 | 290-866-635 | Charge Coil   | <b>326402</b> | <b>52.55</b>  | L |
| SP                        | 580  | 89-91 | 410-912-000 | Charge Coil   | <b>326402</b> | <b>52.55</b>  | L |
| XP                        | 580  | 91-94 | 410-912-000 | Charge Coil   | <b>326402</b> | <b>52.55</b>  | L |
| XPI                       | 580  | 94    | 410-912-000 | Charge Coil   | <b>326402</b> | <b>52.55</b>  | L |
| GTS                       | 580  | 92-95 | 290-965-400 | Charge Coil   | <b>326403</b> | <b>35.00</b>  | L |
| GTX                       | 580  | 92-93 | 410-915-200 | Charge Coil   | <b>326403</b> | <b>35.00</b>  | L |
| SP                        | 580  | 92-96 | 410-915-200 | Charge Coil   | <b>326403</b> | <b>35.00</b>  | L |
| SPI                       | 580  | 93-96 | 410-915-200 | Charge Coil   | <b>326403</b> | <b>35.00</b>  | L |
| SPX                       | 580  | 93    | 410-915-200 | Charge Coil   | <b>326403</b> | <b>35.00</b>  | L |
| XP                        | 580  | 92    | 410-915-200 | Charge Coil   | <b>326403</b> | <b>35.00</b>  | L |

## COILS / ARMATURE CONTINUED

| MODEL                    | CC   | YEAR      | OEM #       | DESCRIPTION   | PART # |          |
|--------------------------|------|-----------|-------------|---------------|--------|----------|
| <b>SEA-DOO CONTINUED</b> |      |           |             |               |        |          |
| GTX                      | 650  | 95        | 410-915-200 | Charge Coil   | 326403 | 35.00 L  |
| SPX                      | 650  | 94-95     | 410-915-200 | Charge Coil   | 326403 | 35.00 L  |
| GS                       | 720  | 97-01     | 410-915-200 | Charge Coil   | 326403 | 35.00 L  |
| GSI                      | 720  | 97        | 410-915-200 | Charge Coil   | 326403 | 35.00 L  |
| GTI                      | 720  | 96-05     | 410-915-200 | Charge Coil   | 326403 | 35.00 L  |
| GTI LE                   | 720  | 02-04     | 410-915-200 | Charge Coil   | 326403 | 35.00 L  |
| GTS                      | 720  | 96-01     | 410-915-200 | Charge Coil   | 326403 | 35.00 L  |
| HX                       | 720  | 95-97     | 410-915-200 | Charge Coil   | 326403 | 35.00 L  |
| SP                       | 720  | 97        | 410-915-200 | Charge Coil   | 326403 | 35.00 L  |
| SPX                      | 720  | 96-97     | 410-915-200 | Charge Coil   | 326403 | 35.00 L  |
| XP                       | 720  | 95        | 410-915-200 | Charge Coil   | 326403 | 35.00 L  |
| GTS                      | 580  | 92-95     | 410-916-200 | Lighting Coil | 326426 | 81.05 L  |
| GTX                      | 580  | 92-93     | 290-965-390 | Lighting Coil | 326426 | 81.05 L  |
| SP                       | 580  | 92-96     | 290-965-390 | Lighting Coil | 326426 | 81.05 L  |
| SPI                      | 580  | 93-96     | 290-965-390 | Lighting Coil | 326426 | 81.05 L  |
| SPX                      | 580  | 93        | 290-965-390 | Lighting Coil | 326426 | 81.05 L  |
| XP                       | 580  | 92        | 290-965-390 | Lighting Coil | 326426 | 81.05 L  |
| GTX                      | 650  | 94-95     | 290-965-390 | Lighting Coil | 326426 | 81.05 L  |
| SPX                      | 650  | 94-95     | 290-965-390 | Lighting Coil | 326426 | 81.05 L  |
| XP                       | 650  | 94        | 290-965-390 | Lighting Coil | 326426 | 81.05 L  |
| XPI                      | 650  | 94        | 290-965-390 | Lighting Coil | 326426 | 81.05 L  |
| GS                       | 720  | 97-01     | 290-965-390 | Lighting Coil | 326426 | 81.05 L  |
| GSI                      | 720  | 97        | 290-965-390 | Lighting Coil | 326426 | 81.05 L  |
| GTI                      | 720  | 96-05     | 290-965-390 | Lighting Coil | 326426 | 81.05 L  |
| GTI LE                   | 720  | 02-04     | 290-965-390 | Lighting Coil | 326426 | 81.05 L  |
| GTS                      | 720  | 96-01     | 290-965-390 | Lighting Coil | 326426 | 81.05 L  |
| HX                       | 720  | 95-97     | 290-965-390 | Lighting Coil | 326426 | 81.05 L  |
| SP                       | 720  | 97        | 290-965-390 | Lighting Coil | 326426 | 81.05 L  |
| SPX                      | 720  | 96-97     | 290-965-390 | Lighting Coil | 326426 | 81.05 L  |
| XP                       | 720  | 95        | 290-965-390 | Lighting Coil | 326426 | 81.05 L  |
| SP                       | 720  | 97        | 290-886-588 | Armature Coil | 326422 | 226.25 L |
| GSX                      | 800  | 96-97     | 420-886-588 | Armature Coil | 326422 | 226.25 L |
| GTX                      | 800  | 96-97     | 290-886-589 | Armature Coil | 326422 | 226.25 L |
| SPX                      | 800  | 97-99     | 420-886-589 | Armature Coil | 326422 | 226.25 L |
| XP                       | 800  | 95-97     | 290-886-590 | Armature Coil | 326422 | 226.25 L |
| 3D RFI                   | 800  | 05        | 290-887-950 | Armature Coil | 326423 | 226.25 L |
| GSX RFI                  | 800  | 99-00     | 420-887-951 | Armature Coil | 326423 | 226.25 L |
| GTI RFI                  | 800  | 03-05     | 420-887-951 | Armature Coil | 326423 | 226.25 L |
| GTX RFI                  | 800  | 98-02     | 420-887-951 | Armature Coil | 326423 | 226.25 L |
| GTX DI                   | 951  | 2000-2003 | 290888651   | Armature Coil | 329242 | 224.95 L |
| LRV DI                   | 951  | 2002-2003 | 420888652   | Armature Coil | 329242 | 224.95 L |
| RX DI                    | 951  | 2000-2003 | 420888652   | Armature Coil | 329242 | 224.95 L |
| XP DI                    | 951  | 2003      | 420888652   | Armature Coil | 329242 | 224.95 L |
| 3D DI                    | 951  | 2006-2007 | 420888656   | Armature Coil | 329243 | 224.95 L |
| XP DI                    | 951  | 2004      | 420888656   | Armature Coil | 329243 | 224.95 L |
| GSX                      | 951  | 98-99     | 420-886-590 | Armature Coil | 326422 | 226.25 L |
| GTX                      | 951  | 98-02     | 290-886-591 | Armature Coil | 326422 | 226.25 L |
| LRV                      | 951  | 00-01     | 420-886-591 | Armature Coil | 326422 | 226.25 L |
| RX                       | 951  | 00-02     | 290-886-592 | Armature Coil | 326422 | 226.25 L |
| RX X                     | 951  | 01        | 420-886-592 | Armature Coil | 326422 | 226.25 L |
| XP                       | 951  | 00-02     | 290-886-593 | Armature Coil | 326422 | 226.25 L |
| XP LTD                   | 951  | 98-99     | 420-886-593 | Armature Coil | 326422 | 226.25 L |
| GTI (All)                | 1503 | 06-14     | 420-889-721 | Armature Coil | 326425 | 221.95 L |
| GTX (All)                | 1503 | 06-14     | 420-889-721 | Armature Coil | 326425 | 221.95 L |
| RXP (All)                | 1503 | 06-09     | 420-889-721 | Armature Coil | 326425 | 221.95 L |
| RXT (All)                | 1503 | 06-14     | 420-889-721 | Armature Coil | 326425 | 221.95 L |
| WAKE 155                 | 1503 | 08-14     | 420-889-721 | Armature Coil | 326425 | 221.95 L |
| WAKE PRO 215             | 1503 | 08-14     | 420-889-721 | Armature Coil | 326425 | 221.95 L |
| Challenger 180           | 1503 | 05-06     | 420889720   | Armature Coil | 329246 | 224.95 L |
| Speedster 200            | 1503 | 05-06     | 290889720   | Armature Coil | 329246 | 224.95 L |
| Sportster 4-Tec          | 1503 | 05-06     | 290889720   | Armature Coil | 329246 | 224.95 L |
| Utopia 205               | 1503 | 06        | 290889720   | Armature Coil | 329246 | 224.95 L |
| GTX                      | 1503 | 02-05     | 290889720   | Armature Coil | 329246 | 224.95 L |
| GTX LTD. S.C. 185        | 1503 | 03-04     | 290889720   | Armature Coil | 329246 | 224.95 L |
| GTX Wake                 | 1503 | 03-05     | 290889720   | Armature Coil | 329246 | 224.95 L |

accessories

towables

body

controls

electrical

driveline

engine

fuel &amp; intake

chemicals

tie downs

tools

towing &amp; loading

MARINE

## COILS / ARMATURE CONTINUED

|                  | MODEL                    | CC   | YEAR  | OEM #           | DESCRIPTION     | PART # |           |
|------------------|--------------------------|------|-------|-----------------|-----------------|--------|-----------|
|                  | <b>SEA-DOO CONTINUED</b> |      |       |                 |                 |        |           |
| accessories      | RXP S.C. 215             | 1503 | 04-05 | 290889720       | Armature Coil   | 329246 | 224.95 L  |
| towables         | RXT S.C. 215             | 1503 | 2005  | 290889720       | Armature Coil   | 329246 | 224.95 L  |
|                  | GTS                      | 580  | 95-97 | 290-886-726     | Stator Assembly | 326424 | 219.95 L  |
| body             | SPI                      | 580  | 95    | 420-886-725     | Stator Assembly | 326424 | 219.95 L  |
|                  | GTX                      | 650  | 95    | 420-886-725     | Stator Assembly | 326424 | 219.95 L  |
|                  | SP                       | 650  | 95    | 420-886-725     | Stator Assembly | 326424 | 219.95 L  |
|                  | SPX                      | 650  | 95    | 420-886-725     | Stator Assembly | 326424 | 219.95 L  |
| controls         | XP                       | 650  | 95    | 420-886-725     | Stator Assembly | 326424 | 219.95 L  |
|                  | GS                       | 720  | 97    | 420-886-725     | Stator Assembly | 326424 | 219.95 L  |
|                  | GSI                      | 720  | 97    | 420-886-725     | Stator Assembly | 326424 | 219.95 L  |
| electrical       | GTI                      | 720  | 96-05 | 420-886-725     | Stator Assembly | 326424 | 219.95 L  |
|                  | HX                       | 720  | 95-97 | 420-886-725     | Stator Assembly | 326424 | 219.95 L  |
|                  | SP                       | 720  | 96-97 | 420-886-725     | Stator Assembly | 326424 | 219.95 L  |
| driveline        | SPI                      | 720  | 96    | 420-886-725     | Stator Assembly | 326424 | 219.95 L  |
|                  | SPX                      | 720  | 96-97 | 420-886-725     | Stator Assembly | 326424 | 219.95 L  |
|                  | <b>YAMAHA</b>            |      |       |                 |                 |        |           |
| engine           | FX All Including SHO     |      | 08-15 | 6S5-82310-00    | Ignition Coil   | 329036 | 116.82 L  |
|                  | FZR / FZS                |      | 09-15 | 6S5-82310-00    | Ignition Coil   | 329036 | 116.82 L  |
|                  | VXR / VXS                |      | 11-14 | 6S5-82310-00    | Ignition Coil   | 329036 | 116.82 L  |
| fuel & intake    | Wave Jammer              | 500  | 89-90 | 6K8-85570-10-00 | Ignition Coil   | 326387 | 57.90 L   |
|                  | Wave Runner              | 500  | 89-93 | 6K8-85570-19-00 | Ignition Coil   | 326387 | 57.90 L   |
|                  | Super Jet                | 650  | 91    | 6M6-85570-00-00 | Ignition Coil   | 326393 | 64.95 L   |
| chemicals        | Wave Runner III          | 650  | 90-93 | 6R8-85570-00-00 | Ignition Coil   | 326393 | 64.95 L   |
|                  | Wave Runner LX           | 650  | 91    | 62E-85570-00-00 | Ignition Coil   | 326393 | 64.95 L   |
|                  | Super Jet                | 700  | 99-15 | 62E-85570-10-00 | Ignition Coil   | 326393 | 64.95 L   |
| tie downs        | Wave Blaster             | 700  | 93-96 | 62E-85570-11-00 | Ignition Coil   | 326393 | 64.95 L   |
|                  | Wave Raider              | 700  | 94-95 | 62E-85570-11-00 | Ignition Coil   | 326393 | 64.95 L   |
|                  | Wave Raider              | 700  | 94-97 | 62E-85570-11-00 | Ignition Coil   | 326393 | 64.95 L   |
|                  | Wave Runner III          | 700  | 94    | 62E-85570-11-00 | Ignition Coil   | 326393 | 64.95 L   |
| tools            | Wave Venture             | 700  | 95-96 | 62E-85570-11-00 | Ignition Coil   | 326393 | 64.95 L   |
|                  | GP                       | 760  | 99-00 | 64X-85570-00-00 | Ignition Coil   | 326419 | 173.20 ZB |
|                  | Wave Raider              | 760  | 96-97 | 64X-85570-01-00 | Ignition Coil   | 326419 | 173.20 ZB |
|                  | Wave Runner XL           | 760  | 97-99 | 64X-85570-01-00 | Ignition Coil   | 326419 | 173.20 ZB |
| towing & loading | Wave Venture             | 760  | 96-97 | 64X-85570-01-00 | Ignition Coil   | 326419 | 173.20 ZB |
|                  | GP                       | 800  | 98-05 | 64X-85570-01-00 | Ignition Coil   | 326419 | 173.20 ZB |
|                  | Wave Runner XA           | 800  | 04    | 64X-85570-01-00 | Ignition Coil   | 326419 | 173.20 ZB |
|                  | Wave Runner XL           | 800  | 00-01 | 64X-85570-01-00 | Ignition Coil   | 326419 | 173.20 ZB |
|                  | Wave Runner XLT          | 800  | 02-03 | 64X-85570-01-00 | Ignition Coil   | 326419 | 173.20 ZB |
|                  | V1 / V1 Sport            | 1100 | 15    | 6D3-82310-00-00 | Ignition Coil   | 326421 | 103.10 H  |
|                  | Wave Raider              | 1100 | 95-96 | 63M-85570-00-00 | Ignition Coil   | 326417 | 66.75 L   |
|                  | Wave Venture             | 1100 | 96-97 | 63M-85570-00-00 | Ignition Coil   | 326417 | 66.75 L   |
|                  | FX / VX All              | 1100 | 05-15 | 6B6-82310-00-00 | Ignition Coil   | 326421 | 103.10 H  |
|                  | GP                       | 1200 | 97-99 | 65U-85570-00-00 | Ignition Coil   | 326418 | 52.40 L   |
|                  | SUV                      | 1200 | 99-04 | 65U-85570-00-00 | Ignition Coil   | 326418 | 52.40 L   |
|                  | XL                       | 1200 | 98    | 65U-85570-00-00 | Ignition Coil   | 326418 | 52.40 L   |
|                  | GP                       | 1200 | 00-02 | 66V-85570-00-00 | Ignition Coil   | 326420 | 92.85 ZB  |
|                  | Wave Runner XL           | 1200 | 99-01 | 66V-85570-00-00 | Ignition Coil   | 326420 | 92.85 ZB  |
|                  | Wave Runner XLT          | 1200 | 02-05 | 66V-85570-00-00 | Ignition Coil   | 326420 | 92.85 ZB  |
|                  | GP                       | 1300 | 03-08 | 66V-85570-00-00 | Ignition Coil   | 326420 | 92.85 ZB  |
|                  | Super Jet                | 650  | 90-93 | 6M6-85520-00-00 | Charge Coil     | 326391 | 55.10 L   |
|                  | VXR                      | 650  | 91-95 | 6M6-85520-00-00 | Charge Coil     | 326391 | 55.10 L   |
|                  | Wave Runner III          | 650  | 90-95 | 6M6-85520-00-00 | Charge Coil     | 326391 | 55.10 L   |
|                  | Wave                     | 650  | 96    | 62T-85520-00-00 | Charge Coil     | 326385 | 55.03 L   |
|                  | Runner III               |      |       | 62T-85520-00-00 | Charge Coil     | 326385 | 55.03 L   |
|                  | Wave Runner LX           | 650  | 91-93 | 6M6-85520-00-00 | Charge Coil     | 326391 | 55.10 L   |
|                  | FX1                      | 700  | 94-95 | 6M6-85520-00-00 | Charge Coil     | 326391 | 55.10 L   |
|                  | Super Jet                | 700  | 95    | 6M6-85520-00-00 | Charge Coil     | 326391 | 55.10 L   |
|                  | VXR Pro                  | 700  | 93-94 | 6M6-85520-00-00 | Charge Coil     | 326391 | 55.10 L   |
|                  | Wave Blaster             | 700  | 93-95 | 6M6-85520-00-00 | Charge Coil     | 326391 | 55.10 L   |
|                  | Wave Runner III          | 700  | 94-95 | 6M6-85520-00-00 | Charge Coil     | 326391 | 55.10 L   |
|                  | Super Jet                | 700  | 96-15 | 62T-85520-01-00 | Charge Coil     | 326385 | 55.03 L   |
|                  | Wave Blaster             | 700  | 96    | 62T-85520-01-00 | Charge Coil     | 326385 | 55.03 L   |
|                  | Wave Raider              | 700  | 94-97 | 62T-85520-01-00 | Charge Coil     | 326385 | 55.03 L   |
|                  | Wave Runner III          | 700  | 97    | 62T-85520-01-00 | Charge Coil     | 326385 | 55.03 L   |

## COILS / ARMATURE CONTINUED

| MODEL                   | CC   | YEAR  | OEM #           | DESCRIPTION   | PART # |        |   |
|-------------------------|------|-------|-----------------|---------------|--------|--------|---|
| <b>YAMAHA CONTINUED</b> |      |       |                 |               |        |        |   |
| Wave Venture            | 700  | 95-98 | 62T-85520-01-00 | Charge Coil   | 326385 | 55.03  | L |
| XL                      | 700  | 99-04 | 62T-85520-01-00 | Charge Coil   | 326385 | 55.03  | L |
| GP                      | 760  | 99    | 64X-85520-00-00 | Charge Coil   | 326383 | 49.95  | L |
| Wave Blaster            | 760  | 96-97 | 64X-85520-00-00 | Charge Coil   | 326383 | 49.95  | L |
| Wave Raider             | 760  | 96    | 64X-85520-00-00 | Charge Coil   | 326383 | 49.95  | L |
| Wave Runner             | 760  | 97-98 | 64X-85520-00-00 | Charge Coil   | 326383 | 49.95  | L |
| Wave Venture            | 760  | 97    | 64X-85520-00-00 | Charge Coil   | 326383 | 49.95  | L |
| XL                      | 760  | 98-99 | 64X-85520-00-00 | Charge Coil   | 326383 | 49.95  | L |
| Wave Jammer             | 500  | 89-90 | 6K8-81303-40-00 | Lighting Coil | 326389 | 39.35  | L |
| Wave Runner             | 500  | 89-93 | 6E7-81303-40-00 | Lighting Coil | 326389 | 39.35  | L |
| Super Jet               | 650  | 90-93 | 6M6-85533-00-00 | Lighting Coil | 326392 | 37.55  | L |
| VXR                     | 650  | 91-95 | 6M6-85533-00-00 | Lighting Coil | 326392 | 37.55  | L |
| Wave Runner III         | 650  | 90-95 | 6M6-85533-00-00 | Lighting Coil | 326392 | 37.55  | L |
| Wave                    | 650  | 96    | 62T-85533-00-00 | Lighting Coil | 326384 | 62.00  | L |
| Runner III              |      |       | 62T-85533-00-00 | Lighting Coil | 326384 | 62.00  | L |
| Wave Runner LX          | 650  | 91-93 | 6M6-85533-00-00 | Lighting Coil | 326392 | 37.55  | L |
| FX1                     | 700  | 91-95 | 6M6-85533-00-00 | Lighting Coil | 326392 | 37.55  | L |
| Super Jet               | 700  | 95    | 6M6-85533-00-00 | Lighting Coil | 326392 | 37.55  | L |
| VXR Pro                 | 700  | 93-94 | 6M6-85533-00-00 | Lighting Coil | 326392 | 37.55  | L |
| Wave Blaster            | 700  | 93-95 | 6M6-85533-00-00 | Lighting Coil | 326392 | 37.55  | L |
| Wave Runner III         | 700  | 94-95 | 6M6-85533-00-00 | Lighting Coil | 326392 | 37.55  | L |
| Super Jet               | 700  | 96-15 | 62T-85533-00-00 | Lighting Coil | 326384 | 62.00  | L |
| Wave Blaster            | 700  | 96    | 62T-85533-00-00 | Lighting Coil | 326384 | 62.00  | L |
| Wave Raider             | 700  | 94-97 | 62T-85533-00-00 | Lighting Coil | 326384 | 62.00  | L |
| Wave Runner III         | 700  | 97    | 62T-85533-00-00 | Lighting Coil | 326384 | 62.00  | L |
| Wave Venture            | 700  | 95-98 | 62T-85533-00-00 | Lighting Coil | 326384 | 62.00  | L |
| XL                      | 700  | 99-04 | 62T-85533-00-00 | Lighting Coil | 326384 | 62.00  | L |
| GP                      | 760  | 99-00 | 62T-85533-00-00 | Lighting Coil | 326384 | 62.00  | L |
| Wave Blaster            | 760  | 96-97 | 62T-85533-00-00 | Lighting Coil | 326384 | 62.00  | L |
| Wave Raider             | 760  | 96    | 62T-85533-00-00 | Lighting Coil | 326384 | 62.00  | L |
| Wave Runner             | 760  | 97-98 | 62T-85533-00-00 | Lighting Coil | 326384 | 62.00  | L |
| Wave Venture            | 760  | 97    | 62T-85533-00-00 | Lighting Coil | 326384 | 62.00  | L |
| XL                      | 760  | 98-99 | 62T-85533-00-00 | Lighting Coil | 326384 | 62.00  | L |
| Wave Jammer             | 500  | 89-90 | 6K8-85580-00    | Pulser Coil   | 326386 | 41.45  | L |
| Wave Runner             | 500  | 89-93 | 6K8-85580-00    | Pulser Coil   | 326386 | 41.45  | L |
| Super Jet               | 650  | 90-93 | 6M6-85580-00-00 | Pulser Coil   | 326390 | 38.30  | L |
| VXR                     | 650  | 91-95 | 6M6-85580-00-00 | Pulser Coil   | 326390 | 38.30  | L |
| Wave Runner III         | 650  | 90-96 | 6M6-85580-00-00 | Pulser Coil   | 326390 | 38.30  | L |
| Wave Runner LX          | 650  | 91-93 | 6M6-85580-00-00 | Pulser Coil   | 326390 | 38.30  | L |
| FX1                     | 700  | 94-95 | 6M6-85580-00-00 | Pulser Coil   | 326390 | 38.30  | L |
| Super Jet               | 700  | 95-99 | 6M6-85580-00-00 | Pulser Coil   | 326390 | 38.30  | L |
| VXR Pro                 | 700  | 93-94 | 6M6-85580-00-00 | Pulser Coil   | 326390 | 38.30  | L |
| Wave Blaster            | 700  | 93-96 | 6M6-85580-00-00 | Pulser Coil   | 326390 | 38.30  | L |
| Wave Raider             | 700  | 94-97 | 6M6-85580-00-00 | Pulser Coil   | 326390 | 38.30  | L |
| Wave Runner III         | 700  | 94-97 | 6M6-85580-00-00 | Pulser Coil   | 326390 | 38.30  | L |
| Wave Venture            | 700  | 95-98 | 6M6-85580-00-00 | Pulser Coil   | 326390 | 38.30  | L |
| XL                      | 700  | 99    | 6M6-85580-00-00 | Pulser Coil   | 326390 | 38.30  | L |
| Super Jet               | 650  | 90-95 | 6R7-85560-00-00 | Stator Plate  | 326462 | 278.95 | L |
| VXR                     | 650  | 91-95 | 6R8-85560-00-00 | Stator Plate  | 326462 | 278.95 | L |
| Wave Runner III         | 650  | 90-95 | 6R8-85560-00-00 | Stator Plate  | 326462 | 278.95 | L |
| Wave                    | 650  | 96    | 62T-85560-00-00 | Stator Plate  | 326460 | 291.25 | L |
| Runner III              |      |       | 62T-85560-00-00 | Stator Plate  | 326460 | 291.25 | L |
| FX1                     | 700  | 94-95 | 6R8-85560-00-00 | Stator Plate  | 326462 | 278.95 | L |
| VXR Pro                 | 700  | 93-94 | 6R8-85560-00-00 | Stator Plate  | 326462 | 278.95 | L |
| Wave Blaster            | 700  | 93-95 | 6R8-85560-00-00 | Stator Plate  | 326462 | 278.95 | L |
| Wave Runner III         | 700  | 94-95 | 6R8-85560-00-00 | Stator Plate  | 326462 | 278.95 | L |
| Super Jet               | 700  | 96-15 | 6R7-85560-10-00 | Stator Plate  | 326460 | 291.25 | L |
| Wave Blaster            | 700  | 96    | 6R8-85560-10-00 | Stator Plate  | 326460 | 291.25 | L |
| Wave Raider             | 700  | 94-97 | 6R8-85560-10-00 | Stator Plate  | 326460 | 291.25 | L |
| Wave Runner III         | 700  | 97    | 6R8-85560-10-00 | Stator Plate  | 326460 | 291.25 | L |
| Wave Venture            | 700  | 95-98 | 6R8-85560-10-00 | Stator Plate  | 326460 | 291.25 | L |
| XL                      | 700  | 99-03 | 6R8-85560-10-00 | Stator Plate  | 326460 | 291.25 | L |
| GP                      | 1200 | 97-99 | 65U-85510-00-00 | Armature Coil | 326461 | 170.55 | L |
| SUV                     | 1200 | 99    | 65U-85510-00-00 | Armature Coil | 326461 | 170.55 | L |
| XL                      | 1200 | 98    | 65U-85510-00-00 | Armature Coil | 326461 | 170.55 | L |

accessories

towables

body

controls

electrical

driveline

engine

fuel &amp; intake

chemicals

tie downs

tools

towing &amp; loading

MARINE

## RECTIFIERS/REGULATORS • STATORS



All of Rick's rectifier regulators are brand new parts and come with a one year replacement warranty. Most units are direct replacement pieces and come with the factory plug ends. This allows for an easy install – just unplug your part and plug ours in. We also know there is a need for universal rectifier regulators for certain unique machines. In this case, the rectifier regulator will come with wire leads only and you will need to hard wire it. Before replacing your rectifier regulator, be sure to read the instructions & check the integrity of all your electrical connectors.

- accessories
- towables
- body
- controls
- electrical**
- driveline
- engine
- fuel & intake
- chemicals
- tie downs
- tools
- towing & loading

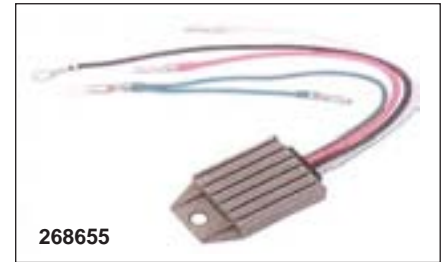
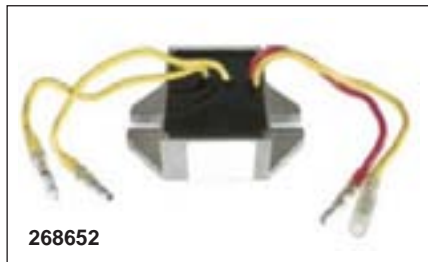

## RECTIFIERS/REGULATORS

| KAWASAKI   |       | RECTIFIER/REGULATOR |               |              |   |
|------------|-------|---------------------|---------------|--------------|---|
| MODEL      | YEAR  | MFG #               | PART #        |              |   |
| 750SX      | 92-95 | 10-W001             | <b>268649</b> | <b>89.00</b> | B |
| 750SXi     | 95-97 |                     |               |              |   |
| 750SXi Pro | 98-02 |                     |               |              |   |
| 800SX-R    | 03-08 |                     |               |              |   |

| SEA-DOO       |       | RECTIFIER/REGULATOR |               |              |   |
|---------------|-------|---------------------|---------------|--------------|---|
| MODEL         | YEAR  | MFG #               | PART #        |              |   |
| 800GSX RFI    | 00    | 10-W003             | <b>268651</b> | <b>98.50</b> | B |
| 800GTI RFI    | 04    |                     |               |              |   |
| 800GTI LE RFI | 03-04 |                     |               |              |   |
| 800GTX RFI    | 00-02 |                     |               |              |   |
| 951GTX DI     | 00-03 |                     |               |              |   |
| 951RV DI      | 02    |                     |               |              |   |
| 951RX DI      | 00-03 |                     |               |              |   |
| 951XP DI      | 03-04 |                     |               |              |   |

| KAWASAKI          |       | RECTIFIER/REGULATOR |               |              |   |
|-------------------|-------|---------------------|---------------|--------------|---|
| MODEL             | YEAR  | MFG #               | PART #        |              |   |
| 750SS             | 92-97 | 10-W002             | <b>268650</b> | <b>89.00</b> | B |
| 750ST             | 94-95 |                     |               |              |   |
| 750STS            | 95-97 |                     |               |              |   |
| 750STX            | 98    |                     |               |              |   |
| 750Super Sport Xi | 93-97 |                     |               |              |   |
| 750Xi R           | 94    |                     |               |              |   |
| 750Xi Sport       | 98-99 |                     |               |              |   |

| SEA-DOO |       | RECTIFIER/REGULATOR |               |              |   |
|---------|-------|---------------------|---------------|--------------|---|
| MODEL   | YEAR  | MFG #               | PART #        |              |   |
| 720SP   | 97    | 10-W005             | <b>268653</b> | <b>45.00</b> | B |
| 800GSX  | 96    |                     |               |              |   |
| 800GTX  | 96-97 |                     |               |              |   |
| 800SPX  | 97-99 |                     |               |              |   |
| 800XP   | 95-96 |                     |               |              |   |





## RECTIFIERS/REGULATORS • STATORS CONTINUED

| SEA-DOO |       | RECTIFIER/REGULATOR |        |       |   |
|---------|-------|---------------------|--------|-------|---|
| MODEL   | YEAR  | MFG #               | PART # |       |   |
| 580GT   | 90-91 | 10-W004             | 268652 | 45.00 | B |
| 580GTS  | 92-95 |                     |        |       |   |
| 580GTX  | 92-95 |                     |        |       |   |
| 580SP   | 90-97 |                     |        |       |   |
| 580SPI  | 93-96 |                     |        |       |   |
| 650XP   | 93-94 |                     |        |       |   |
| 650XPI  | 94    |                     |        |       |   |
| 720GTI  | 96-97 |                     |        |       |   |
| 720GTS  | 96-00 |                     |        |       |   |
| 720HX   | 95-97 |                     |        |       |   |
| 720SPX  | 93-96 |                     |        |       |   |
| 720XP   | 95    |                     |        |       |   |
| 800SPX  | 97    |                     |        |       |   |

| SEA-DOO                                    |       | RECTIFIER/REGULATOR |        |       |   |
|--|-------|---------------------|--------|-------|---|
| MODEL                                      | YEAR  | MFG #               | PART # |       |   |
| 1500GTX 4-Tec                              | 02-03 | 10-W006             | 268654 | 98.50 | B |
| 1500GTX 4-Tec Supercharged/LTD/WakeboardEd | 03    |                     |        |       |   |

| SEA-DOO   |       | RECTIFIER/REGULATOR |        |       |   |
|-----------|-------|---------------------|--------|-------|---|
| MODEL     | YEAR  | MFG #               | PART # |       |   |
| 720GS     | 97-01 | 10-W007             | 268655 | 53.00 | B |
| 720GS1    | 97    |                     |        |       |   |
| 720GTI    | 97-05 |                     |        |       |   |
| 720GTI LE | 02-04 |                     |        |       |   |
| 720GTS    | 97    |                     |        |       |   |
| 800XP     | 97    |                     |        |       |   |

| YAMAHA                     |       | RECTIFIER/REGULATOR |        |       |   |
|----------------------------|-------|---------------------|--------|-------|---|
| MODEL                      | YEAR  | MFG #               | PART # |       |   |
| GP1200                     | 97-99 | 10-W008             | 268656 | 59.95 | B |
| GP1200W                    | 97-99 |                     |        |       |   |
| GP1200X                    | 97-99 |                     |        |       |   |
| SUV1200 4-pass (w/trailer) | 03    |                     |        |       |   |
| SUV1200X                   | 99-01 |                     |        |       |   |
| SUV1200Y                   | 99-01 |                     |        |       |   |
| SUV1200Z                   | 99-01 |                     |        |       |   |
| SV1200 SUV 4-Pass          | 04    |                     |        |       |   |
| SV1200A                    | 02    |                     |        |       |   |
| XL1200W                    | 98    |                     |        |       |   |

| YAMAHA                    |        | RECTIFIER/REGULATOR |        |       |   |
|---------------------------|--------|---------------------|--------|-------|---|
| MODEL                     | YEAR   | MFG #               | PART # |       |   |
| GP800A                    | 98-02  | 10-W009             | 268657 | 59.95 | B |
| GP800R Waverunner 2-Pass  | 03-05  |                     |        |       |   |
| GP800W                    | 98-00* |                     |        |       |   |
| GP800W                    | 02*    |                     |        |       |   |
| GP800W                    | 01     |                     |        |       |   |
| GP800X                    | 98-02  |                     |        |       |   |
| XL800                     | 00     |                     |        |       |   |
| XL800Z                    | 01     |                     |        |       |   |
| XLT800A Waverunner 3-Pass | 02-04  |                     |        |       |   |
| Wave Raider 1100          | 95-96  |                     |        |       |   |
| Wave Venture 1100         | 96-97  |                     |        |       |   |

## STATORS

| SEA-DOO    |       | STATOR  |        |        |   |
|------------|-------|---------|--------|--------|---|
| MODEL      | YEAR  | MFG #   | PART # |        |   |
| 720SP      | 97    | 21-W101 | 268658 | 139.95 | D |
| 800GSX     | 97-98 |         |        |        |   |
| 800GTX     | 96-97 |         |        |        |   |
| 800SPX     | 97-99 |         |        |        |   |
| 800XP      | 95-97 |         |        |        |   |
| 951GSX Ltd | 98-99 |         |        |        |   |
| 951GTX     | 00-02 |         |        |        |   |
| 951GTX Ltd | 98-99 |         |        |        |   |
| 951LVR     | 00-01 |         |        |        |   |
| 951RX      | 00-02 |         |        |        |   |
| 951RX X    | 01    |         |        |        |   |
| 951XP      | 00-02 |         |        |        |   |
| 951XP Ltd  | 98-99 |         |        |        |   |

| YAMAHA            |       | STATOR  |        |        |   |
|-------------------|-------|---------|--------|--------|---|
| MODEL             | YEAR  | MFG #   | PART # |        |   |
| FX1000            | 05-08 | 21-W102 | 268659 | 159.95 | D |
| FX1000 Cruiser    | 03-08 |         |        |        |   |
| FX1000 FX140      | 02-04 |         |        |        |   |
| AR210             | 06-11 |         |        |        |   |
| FX1100 Cruiser HO | 04-08 |         |        |        |   |
| FX1100 HO         | 04-08 |         |        |        |   |
| SR210             | 06-07 |         |        |        |   |
| SX210             | 06-11 |         |        |        |   |
| VX1100 Cruiser    | 07-11 |         |        |        |   |
| VX1100 Delux      | 05-11 |         |        |        |   |
| VX1100 Sport      | 05-11 |         |        |        |   |
| GP1300R           | 03-08 |         |        |        |   |

- accessories
- towables
- body
- controls
- electrical
- driveline
- engine
- fuel & intake
- chemicals
- tie downs
- tools
- towing & loading

MARINE



## VOLTAGE REGULATORS

OEM QUALITY REPLACEMENT PARTS AT A LOW PRICE

- accessories
- towables
- body
- controls
- electrical**
- driveline
- engine
- fuel & intake
- chemicals
- tie downs
- tools
- towing & loading

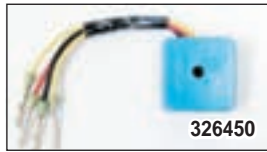
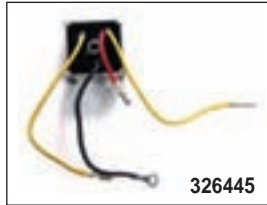
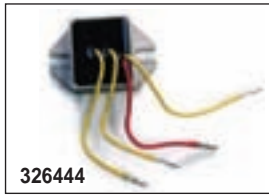

| MAKE/MODEL      | CC   | YEAR  | OEM #      | PART # |       |   |
|-----------------|------|-------|------------|--------|-------|---|
| <b>KAWASAKI</b> |      |       |            |        |       |   |
| SX              | 300  | 89-91 | 21066-3707 | 326450 | 61.75 | L |
| JS              | 440  | 92    | 21066-3710 | 326456 | 53.95 | L |
| SX              | 550  | 92-95 | 21066-3710 | 326456 | 53.95 | L |
| X2              | 650  | 86    | 21066-3702 | 326452 | 49.95 | L |
| SS              | 750  | 92-97 | 21066-3711 | 326457 | 39.95 | L |
| SS XI           | 750  | 93-97 | 21066-3711 | 326457 | 39.95 | L |
| ST              | 750  | 94-95 | 21066-3711 | 326457 | 39.95 | L |
| STS             | 750  | 95-97 | 21066-3711 | 326457 | 39.95 | L |
| STX             | 750  | 98    | 21066-3711 | 326457 | 39.95 | L |
| XI SPORT        | 750  | 98-99 | 21066-3711 | 326457 | 39.95 | L |
| XiR             | 750  | 94    | 21066-3711 | 326457 | 39.95 | L |
| SX              | 750  | 92-95 | 21066-3709 | 326455 | 99.95 | L |
| SXI             | 750  | 95-97 | 21066-3709 | 326455 | 99.95 | L |
| SXI PRO         | 750  | 98-02 | 21066-3709 | 326455 | 99.95 | L |
| SX-R            | 800  | 03-11 | 21066-3709 | 326455 | 99.95 | L |
| ZXI             | 750  | 95-97 | 21066-3712 | 326458 | 29.95 | L |
| STS             | 900  | 01-02 | 21066-3712 | 326458 | 29.95 | L |
| STX             | 900  | 97-06 | 21066-3712 | 326458 | 29.95 | L |
| ZXI             | 900  | 95-97 | 21066-3712 | 326458 | 29.95 | L |
| STX             | 1100 | 97-99 | 21066-3712 | 326458 | 29.95 | L |
| ZXI             | 1100 | 96-03 | 21066-3712 | 326458 | 29.95 | L |
| ULTRA 150       | 1200 | 99-05 | 21066-3715 | 326459 | 49.95 | L |
| STX-12F         | 1200 | 04-07 | 21066-3718 | 329151 | 79.95 | L |
| STX             | 1500 | 09-10 | 21066-3718 | 329151 | 79.95 | L |



## VOLTAGE REGULATORS CONTINUED

| MAKE/MODEL                | CC  | YEAR  | OEM #      | PART # |        |   |
|---------------------------|-----|-------|------------|--------|--------|---|
| <b>KAWASAKI CONTINUED</b> |     |       |            |        |        |   |
| 1500 STX                  |     | 09-10 | 21066-3718 | 329151 | 79.95  | L |
| 1500 STX-15F              |     | 04-15 | 21066-3718 | 329151 | 79.95  | L |
| 1500 Ultra 250X           |     | 07-08 | 21066-3718 | 329151 | 79.95  | L |
| 1500 Ultra 260LX          |     | 09-10 | 21066-3718 | 329151 | 79.95  | L |
| 1500 Ultra 260X           |     | 09-10 | 21066-3718 | 329151 | 79.95  | L |
| 1500 Ultra 300LX          |     | 11-13 | 21066-3718 | 329151 | 79.95  | L |
| 1500 Ultra 300X           |     | 11-13 | 21066-3718 | 329151 | 79.95  | L |
| 1500 Ultra 310LX          |     | 14-15 | 21066-3718 | 329151 | 79.95  | L |
| 1500 Ultra 310R           |     | 14-15 | 21066-3718 | 329151 | 79.95  | L |
| 1500 Ultra 310X           |     | 14-15 | 21066-3718 | 329151 | 79.95  | L |
| 1500 Ultra 310X SE        |     | 14-15 | 21066-3718 | 329151 | 79.95  | L |
| 1500 Ultra LX             |     | 07-15 | 21066-3718 | 329151 | 79.95  | L |
| <b>SEA-DOO</b>            |     |       |            |        |        |   |
| GT                        | 580 | 90-91 | 278000123  | 326445 | 38.32  | L |
| GTS                       | 580 | 92-95 | 278000123  | 326445 | 38.32  | L |
| GTX                       | 580 | 92-93 | 278000123  | 326445 | 38.32  | L |
| SP                        | 580 | 90-96 | 278000123  | 326445 | 38.32  | L |
| SPI                       | 580 | 93-96 | 278000123  | 326445 | 38.32  | L |
| SPX                       | 580 | 93    | 278000123  | 326445 | 38.32  | L |
| XP                        | 580 | 91-92 | 278000123  | 326445 | 38.32  | L |
| GTX                       | 650 | 94-95 | 278000123  | 326445 | 38.32  | L |
| SPX                       | 650 | 94-95 | 278000123  | 326445 | 38.32  | L |
| XPI                       | 650 | 94    | 278000123  | 326445 | 38.32  | L |
| GTI                       | 720 | 96-97 | 278000123  | 326445 | 38.32  | L |
| GTS                       | 720 | 96-00 | 278000123  | 326445 | 38.32  | L |
| HX                        | 720 | 95-97 | 278000123  | 326445 | 38.32  | L |
| SP                        | 720 | 97    | 278000123  | 326445 | 38.32  | L |
| SPX                       | 720 | 96-97 | 278000123  | 326445 | 38.32  | L |
| XP                        | 720 | 93-94 | 278000123  | 326445 | 38.32  | L |
| XP                        | 800 | 95    | 278000123  | 326445 | 38.32  | L |
| GS                        | 720 | 97-01 | 278001239  | 326446 | 32.95  | L |
| GSI                       | 720 | 97    | 278001056  | 326446 | 32.95  | L |
| GTI                       | 720 | 97-05 | 278001056  | 326446 | 32.95  | L |
| GTI LE                    | 720 | 02-04 | 278001056  | 326446 | 32.95  | L |
| GTS                       | 720 | 97-02 | 278001056  | 326446 | 32.95  | L |
| SP                        | 720 | 97    | 278000443  | 326444 | 37.95  | L |
| GSX                       | 800 | 96    | 278000443  | 326444 | 37.95  | L |
| GTX                       | 800 | 96-97 | 278000443  | 326444 | 37.95  | L |
| SPX                       | 800 | 97-99 | 278000443  | 326444 | 37.95  | L |
| XP                        | 800 | 95-96 | 278000443  | 326444 | 37.95  | L |
| GSX                       | 800 | 97    | 278001240  | 326449 | 46.35  | J |
| XP                        | 800 | 97    | 278001073  | 326449 | 46.35  | J |
| GSX RFI                   | 800 | 99-00 | 278001241  | 326447 | 122.70 | L |
| GTI LE RFI                | 800 | 03-04 | 278001554  | 326447 | 122.70 | L |
| GTI RFI                   | 800 | 04    | 278001554  | 326447 | 122.70 | L |
| GTX RFI                   | 800 | 98-02 | 278001554  | 326447 | 122.70 | L |
| GTX DI                    | 951 | 00-03 | 278001554  | 326447 | 122.70 | L |
| LRV DI                    | 951 | 02    | 278001554  | 326447 | 122.70 | L |
| RX DI                     | 951 | 00-03 | 278001554  | 326447 | 122.70 | L |
| XP DI                     | 951 | 03-04 | 278001554  | 326447 | 122.70 | L |
| 3D RFI                    | 800 | 05    | 278001969  | 326454 | 109.95 | L |
| GTI RFI                   | 800 | 05    | 278001581  | 326454 | 109.95 | L |
| 3D DI                     | 951 | 06-07 | 278001581  | 326454 | 109.95 | L |

accessories

towables

body

controls

electrical

driveline

engine

fuel &  
intake

chemicals

tie downs

tools

towing &  
loading

MARINE



## VOLTAGE REGULATORS CONTINUED

- accessories
- towables
- body
- controls
- electrical
- driveline
- engine
- fuel & intake
- chemicals
- tie downs
- tools
- towing & loading

MARINE

| MAKE/MODEL               | CC   | YEAR  | OEM #           | PART # |          |
|--------------------------|------|-------|-----------------|--------|----------|
| <b>SEA-DOO CONTINUED</b> |      |       |                 |        |          |
| GTI                      | 1503 | 06-07 | 278001581       | 326454 | 109.95 L |
| GTX 4-Tec All            | 1503 | 02-07 | 278001581       | 326454 | 109.95 L |
| RXP                      | 1503 | 04-07 | 278001581       | 326454 | 109.95 L |
| RXT                      | 1503 | 05-07 | 278001581       | 326454 | 109.95 L |
| GTI 130                  | 1503 | 08-15 | 710001103       | 329152 | 99.95 L  |
| GTI LTD 155              | 1503 | 11-15 | 710001103       | 329152 | 99.95 L  |
| GTI Rental 130           | 1503 | 08-10 | 710001103       | 329152 | 99.95 L  |
| GTI SE 130               | 1503 | 08-15 | 710001103       | 329152 | 99.95 L  |
| GTI SE 155               | 1503 | 08-14 | 710001103       | 329152 | 99.95 L  |
| GTR 215                  | 1503 | 12-15 | 710001103       | 329152 | 99.95 L  |
| GTS 130                  | 1503 | 11-15 | 710001103       | 329152 | 99.95 L  |
| GTS Pro 130              | 1503 | 11    | 710001103       | 329152 | 99.95 L  |
| GTS Rental 130           | 1503 | 11-13 | 710001103       | 329152 | 99.95 L  |
| GTX 155                  | 1503 | 08-15 | 710001103       | 329152 | 99.95 L  |
| GTX 215                  | 1503 | 08-13 | 710001103       | 329152 | 99.95 L  |
| GTX IS 215               | 1503 | 10-11 | 710001103       | 329152 | 99.95 L  |
| GTX LTD 215              | 1503 | 08    | 710001103       | 329152 | 99.95 L  |
| GTX LTD 215              | 1503 | 14    | 710001103       | 329152 | 99.95 L  |
| GTX LTD IS 255           | 1503 | 09    | 710001103       | 329152 | 99.95 L  |
| GTX LTD IS 260           | 1503 | 10-14 | 710001103       | 329152 | 99.95 L  |
| GTX S 155                | 1503 | 08-15 | 710001103       | 329152 | 99.95 L  |
| GTX WAKE PRO 215         | 1503 | 09-15 | 710001103       | 329152 | 99.95 L  |
| Rental 130               | 1503 | 10    | 710001103       | 329152 | 99.95 L  |
| Rental 99                | 1503 | 11    | 710001103       | 329152 | 99.95 L  |
| RXP 155                  | 1503 | 08    | 710001103       | 329152 | 99.95 L  |
| RXP 215                  | 1503 | 08-09 | 710001103       | 329152 | 99.95 L  |
| RXP-X 255                | 1503 | 08-11 | 710001103       | 329152 | 99.95 L  |
| RXP-X 260                | 1503 | 12    | 710001103       | 329152 | 99.95 L  |
| RXT 215                  | 1503 | 08-10 | 710001103       | 329152 | 99.95 L  |
| RXT 260                  | 1503 | 11-12 | 710001103       | 329152 | 99.95 L  |
| RXT AS X/XRS 260         | 1503 | 11    | 710001103       | 329152 | 99.95 L  |
| RXT IS 255               | 1503 | 09    | 710001103       | 329152 | 99.95 L  |
| RXT IS 260               | 1503 | 10-12 | 710001103       | 329152 | 99.95 L  |
| RXT-X/XRS 260            | 1503 | 10    | 710001103       | 329152 | 99.95 L  |
| RXT-X 255                | 1503 | 08-09 | 710001103       | 329152 | 99.95 L  |
| RXT-X 260                | 1503 | 12-15 | 710001103       | 329152 | 99.95 L  |
| RXT-X AS 260             | 1503 | 12    | 710001103       | 329152 | 99.95 L  |
| Wake 155                 | 1503 | 08-12 | 710001103       | 329152 | 99.95 L  |
| Wake 215                 | 1503 | 08    | 710001103       | 329152 | 99.95 L  |
| Wake Pro 215             | 1503 | 09-12 | 710001103       | 329152 | 99.95 L  |
| <b>YAMAHA</b>            |      |       |                 |        |          |
| Wave Jammer              | 500  | 89-90 | 6M6-81960-AO-00 | 326448 | 25.95 L  |
| Wave Runner              | 500  | 89-93 | 6K8-81960-AO-00 | 326448 | 25.95 L  |
| Super Jet                | 650  | 90-93 | 6K8-81960-AO-00 | 326448 | 25.95 L  |
| Wave Runner              | 650  | 91-99 | 6K8-81960-AO-00 | 326448 | 25.95 L  |
| FX1                      | 700  | 94-95 | 6K8-81960-AO-00 | 326448 | 25.95 L  |
| Super Jet                | 700  | 95-09 | 6K8-81960-AO-00 | 326448 | 25.95 L  |
| Wave Blaster             | 700  | 93-96 | 6K8-81960-AO-00 | 326448 | 25.95 L  |
| Wave Raider              | 700  | 94-96 | 6K8-81960-AO-00 | 326448 | 25.95 L  |
| Wave Runner              | 700  | 93-04 | 6K8-81960-AO-00 | 326448 | 25.95 L  |
| Wave Venture             | 700  | 95-98 | 6K8-81960-AO-00 | 326448 | 25.95 L  |
| GP                       | 760  | 99-00 | 6K8-81960-AO-00 | 326448 | 25.95 L  |



## VOLTAGE REGULATORS CONTINUED

| MAKE/MODEL              | CC    | YEAR  | OEM #           | PART #        |               |   |
|-------------------------|-------|-------|-----------------|---------------|---------------|---|
| <b>YAMAHA CONTINUED</b> |       |       |                 |               |               |   |
| Wave Blaster            | 760   | 96-97 | 6K8-81960-AO-00 | <b>326448</b> | <b>25.95</b>  | L |
| Wave Raider             | 760   | 96    | 6K8-81960-AO-00 | <b>326448</b> | <b>25.95</b>  | L |
| Waver Runner            | 760   | 97-99 | 6K8-81960-AO-00 | <b>326448</b> | <b>25.95</b>  | L |
| LX                      | 650   | 90-92 | 6K8-81960-AO-00 | <b>326448</b> | <b>25.95</b>  | L |
| Super Jet               | 650   | 90-93 | 6K8-81960-AO-00 | <b>326448</b> | <b>25.95</b>  | L |
| VXR                     | 659   | 91-95 | 6K8-81960-AO-00 | <b>326448</b> | <b>25.95</b>  | L |
| Wave Runner III         | 650   | 90-93 | 6K8-81960-AO-00 | <b>326448</b> | <b>25.95</b>  | L |
| FX1                     | 700   | 95-96 | 6K8-81960-AO-00 | <b>326448</b> | <b>25.95</b>  | L |
| Pro VXR                 | 700   | 93-94 | 6K8-81960-AO-00 | <b>326448</b> | <b>25.95</b>  | L |
| Super Jet               | 700   | 94-09 | 6K8-81960-AO-00 | <b>326448</b> | <b>25.95</b>  | L |
| Wave Blaster            | 700   | 93-96 | 6K8-81960-AO-00 | <b>326448</b> | <b>25.95</b>  | L |
| Wave Raider             | 700   | 94-97 | 6K8-81960-AO-00 | <b>326448</b> | <b>25.95</b>  | L |
| Wave Raider Deluxe      | 700   | 95    | 6K8-81960-AO-00 | <b>326448</b> | <b>25.95</b>  | L |
| Wave Runner III         | 700   | 94-95 | 6K8-81960-AO-00 | <b>326448</b> | <b>25.95</b>  | L |
| Wave Runner III         | 700   | 97    | 6K8-81960-AO-00 | <b>326448</b> | <b>25.95</b>  | L |
| Wave Venture            | 700   | 95    | 6K8-81960-AO-00 | <b>326448</b> | <b>25.95</b>  | L |
| Venture                 | 700   | 98    | 6K8-81960-AO-00 | <b>326448</b> | <b>25.95</b>  | L |
| XL                      | 700   | 99-04 | 6K8-81960-AO-00 | <b>326448</b> | <b>25.95</b>  | L |
| GP                      | 760   | 97-00 | 6K8-81960-AO-00 | <b>326448</b> | <b>25.95</b>  | L |
| Wave Blaster            | 760   | 96-97 | 6K8-81960-AO-00 | <b>326448</b> | <b>25.95</b>  | L |
| Wave Raider             | 760   | 96    | 6K8-81960-AO-00 | <b>326448</b> | <b>25.95</b>  | L |
| Wave Venture            | 760   | 97    | 6K8-81960-AO-00 | <b>326448</b> | <b>25.95</b>  | L |
| XL                      | 760   | 98-99 | 6K8-81960-AO-00 | <b>326448</b> | <b>25.95</b>  | L |
| GP800R                  | 800   | 98-05 | 63M-81960-00-00 | <b>326464</b> | <b>25.00</b>  | L |
| Wave Runner XA          | 800   | 04    | 63M-81960-00-00 | <b>326464</b> | <b>25.00</b>  | L |
| Wave Runner XL          | 800   | 00-01 | 63M-81960-00-00 | <b>326464</b> | <b>25.00</b>  | L |
| Wave Runner XLT         | 800   | 02-03 | 63M-81960-00-00 | <b>326464</b> | <b>25.00</b>  | L |
| Wave Raider             | 1100  | 95-96 | 63M-81960-00-00 | <b>326464</b> | <b>25.00</b>  | L |
| Wave Venture            | 1100  | 96-97 | 63M-81960-00-00 | <b>326464</b> | <b>25.00</b>  | L |
| GP                      | 1200  | 97-99 | 6H2-81960-00-00 | <b>326465</b> | <b>28.00</b>  | L |
| SV                      | 1200  | 02-04 | 6H2-81960-00-00 | <b>326465</b> | <b>28.00</b>  | L |
| Wave Runner SUV         | 1200  | 99-03 | 6H2-81960-00-00 | <b>326465</b> | <b>28.00</b>  | L |
| Wave Runner XL          | 1200  | 98    | 6H2-81960-00-00 | <b>326465</b> | <b>28.00</b>  | L |
| GP                      | 1200  | 00-02 | 66V-81960-00-00 | <b>326466</b> | <b>30.00</b>  | L |
| XL                      | 1200  | 99-01 | 66V-81960-00-00 | <b>326466</b> | <b>30.00</b>  | L |
| XLT                     | 1200  | 02-05 | 66V-81960-00-00 | <b>326466</b> | <b>30.00</b>  | L |
| All FX Models           | 1000  | 02-06 | 6D3-81960-00-00 | <b>326467</b> | <b>97.60</b>  | L |
| All VX Models & HO      | 11000 | 04-09 | 68V-81960-00-00 | <b>326467</b> | <b>97.60</b>  | L |
| GP                      | 1300  | 03-08 | 68V-81960-00-00 | <b>326467</b> | <b>97.60</b>  | L |
| FX Cruiser HO           | 1800  | 09-12 | 6S5-81960-00-00 | <b>329153</b> | <b>200.32</b> | L |
| FX Cruiser SHO          | 1800  | 08-12 | 6S5-81960-00-00 | <b>329153</b> | <b>200.32</b> | L |
| FX HO                   | 1800  | 09-12 | 6S5-81960-00-00 | <b>329153</b> | <b>200.32</b> | L |
| FX SHO                  | 1800  | 08-12 | 6S5-81960-00-00 | <b>329153</b> | <b>200.32</b> | L |
| FZR                     | 1800  | 09-12 | 6S5-81960-00-00 | <b>329153</b> | <b>200.32</b> | L |
| FZS                     | 1800  | 09-12 | 6S5-81960-00-00 | <b>329153</b> | <b>200.32</b> | L |
| VXR                     | 1800  | 11-12 | 6S5-81960-00-00 | <b>329153</b> | <b>200.32</b> | L |
| VXS                     | 1800  | 11-12 | 6S5-81960-00-00 | <b>329153</b> | <b>200.32</b> | L |

accessories

towables

body

controls

electrical

driveline

engine

fuel &amp; intake

chemicals

tie downs

tools

towing &amp; loading

MARINE

- accessories
- towables
- body
- controls
- electrical
- driveline
- engine
- fuel & intake
- chemicals
- tie downs
- tools
- towing & loading



## CDI BOXES

OEM QUALITY  
REPLACEMENT PARTS  
AT A LOW PRICE

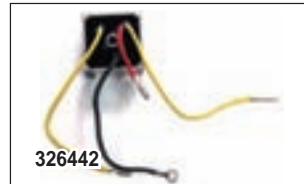
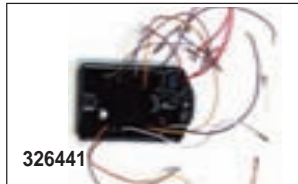
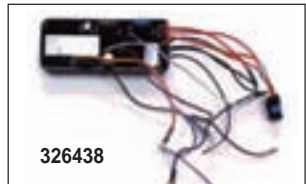
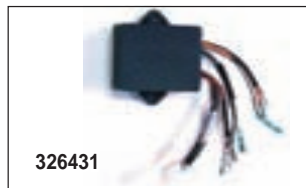

| MAKE/MODEL                    | YEAR  | ARL | PART # |          |
|-------------------------------|-------|-----|--------|----------|
| <b>KAWASAKI</b>               |       |     |        |          |
| 650 CDI COIL                  |       |     | 326428 | 165.99 L |
| Wiring                        |       |     |        |          |
| Blue Wire - Stop Switch       |       |     |        |          |
| Black Wire - Stop Switch      |       |     |        |          |
| Black/Red - Stator Coil Plate |       |     |        |          |
| Black/Yellow - Ground         |       |     |        |          |
| 750 ST                        | 94    |     | 326429 | 219.95 L |
| 750 SS                        | 92-97 |     | 326429 | 219.95 L |
| 750 STX                       | 98    |     | 326429 | 219.95 L |
| 750 STS                       | 95-97 |     | 326429 | 219.95 L |
| 750 Xi                        | 93-97 |     | 326429 | 219.95 L |
| 750 SX                        | All   |     | 326430 | 262.95 L |
| 750 ZXi                       | 95    |     | 326431 | 262.95 L |
| 750/800                       | All   |     | 326432 | 219.95 L |
| STi Pro                       | 98-02 |     | 326432 | 219.95 L |
| SX-R                          | 03    |     | 326432 | 219.95 L |
| SXi                           | 95-96 |     | 326432 | 219.95 L |
| XiR                           | 94    |     | 326432 | 219.95 L |

| <b>SEA-DOO</b> |       |   |        |          |
|----------------|-------|---|--------|----------|
| 580 GTS        | 93-94 | Y | 326436 | 169.95 L |
| 580 GTX        | 93    | Y | 326436 | 169.95 L |
| 650 GTX        | 94    | Y | 326436 | 169.95 L |
| 580 SP         | 93-94 | Y | 326436 | 169.95 L |
| 580 SPI        | 93-94 | Y | 326436 | 169.95 L |
| 580 SPX        | 93    | Y | 326436 | 169.95 L |
| 650 SPX        | 94    | Y | 326436 | 169.95 L |
| 650 XP         | 94    | Y | 326436 | 169.95 L |
| 650 XPI        | 94    | Y | 326436 | 169.95 L |
| 580 GTS        | 95-96 |   | 326437 | 205.95 L |
| 580 SP         | 95    |   | 326437 | 205.95 L |
| 580 SPI        | 95    |   | 326437 | 205.95 L |
| 650 GTX        | 95    |   | 326437 | 205.95 L |
| 650 SPX        | 95    |   | 326437 | 205.95 L |
| 720 HX         | 95    |   | 326437 | 205.95 L |
| 720 XP         | 95    |   | 326437 | 205.95 L |
| 580 GTS        | 95-96 | Y | 326438 | 199.95 L |
| 580 SP         | 95    | Y | 326438 | 199.95 L |
| 580 SPI        | 95    | Y | 326438 | 199.95 L |

| MAKE/MODEL                          | YEAR   | ARL | PART # |          |
|-------------------------------------|--------|-----|--------|----------|
| <b>SEA-DOO CONTINUED</b>            |        |     |        |          |
| 650 GTX                             | 95     | Y   | 326438 | 199.95 L |
| 650 SPX                             | 95     | Y   | 326438 | 199.95 L |
| 720 HX                              | 95     | Y   | 326438 | 199.95 L |
| 720 XP                              | 95     | Y   | 326438 | 199.95 L |
| 720 GS                              | 97-01  |     | 326439 | 259.99 L |
| 720 GSI                             | 97     |     | 326439 | 259.99 L |
| 720 GTI                             | 97-02  |     | 326439 | 259.99 L |
| 720 GTI LE                          | 02     |     | 326439 | 259.99 L |
| 720 GTS                             | 97, 01 |     | 326439 | 259.99 L |
| 720 GS                              | 97-01  | Y   | 326440 | 345.65 L |
| 720 GSI                             | 97     | Y   | 326440 | 345.65 L |
| 720 GTI                             | 97-02  | Y   | 326440 | 345.65 L |
| 720 GTI LE                          | 02     | Y   | 326440 | 345.65 L |
| 720 GTS                             | 97, 01 | Y   | 326440 | 345.65 L |
| 800 GSX High Performance            | 97     |     | 329147 | 773.51 L |
| 800 GSX                             | 96     |     | 329150 | 434.18 L |
| 800 GTX                             | 96     |     | 329150 | 434.18 L |
| 800 XP                              | 96-97  |     | 329150 | 434.18 L |
| 800 GTX                             | 97     |     | 329149 | 768.11 L |
| 800 SPX                             | 97-99  |     | 329149 | 768.11 L |
| 800 XP Fully Programable            | 97     |     | 326442 | 595.00 G |
| 800 XP Fully Programable            | 98     |     | 326443 | 595.00 G |
| 720 SP                              | 97     | Y   | 326441 | 500.95 L |
| 800 SPX                             | 97-99  | Y   | 326441 | 500.95 L |
| Box Fully Programable               |        |     |        |          |
| Security Key Programability         |        |     |        |          |
| Timing & Rev Limiter Programability |        |     |        |          |
| 951 GSX Ltd.                        | All    |     | 329148 | 667.91 L |

| <b>YAMAHA</b>              |     |   |        |          |
|----------------------------|-----|---|--------|----------|
| 650/701 OEM Style          | All |   | 326433 | 179.95 L |
| Non-Adjustable Rev Limiter |     |   |        |          |
| 650/701 OEM Style          | All | Y | 326434 | 233.16 L |
| Adjustable Rev Limiter     |     |   |        |          |
| 650/701 OEM Style          | All |   | 326435 | 233.16 L |
| No Rev Limiter             |     |   |        |          |

\*ARL = ADJUSTABLE REV LIMITER



**DRIVELINE**

# DRIVELINE

## WSM DRIVE SHAFTS

Replace your broken or worn out OEM drive shaft with a new WSM drive shaft. WSM drive shafts are built to exceed the OEM specification, for an exact fit. Couplers and drive shaft couplers are sold separately.



| MODEL            | CC   | YEAR   | OEM #      | PART #        |               |   |
|------------------|------|--------|------------|---------------|---------------|---|
| <b>KAWASAKI</b>  |      |        |            |               |               |   |
| SX               | 650  | 87-93  | 39159-3712 | <b>326210</b> | <b>209.00</b> | L |
| SS               | 750  | 94-97  | 39159-3717 | <b>326212</b> | <b>226.25</b> | L |
| SSXI             | 750  | 93-97  | 39159-3717 | <b>326212</b> | <b>226.25</b> | L |
| ST               | 750  | 94-95  | 39159-3717 | <b>326212</b> | <b>226.25</b> | L |
| STS              | 750  | 95-97  | 39159-3717 | <b>326212</b> | <b>226.25</b> | L |
| STX              | 750  | 98     | 39159-3717 | <b>326212</b> | <b>226.25</b> | L |
| SX               | 750  | 92-95  | 39159-3714 | <b>326211</b> | <b>226.25</b> | L |
| SXI              | 750  | 95     | 39159-3714 | <b>326211</b> | <b>226.25</b> | L |
| Xi Sport         | 750  | 98-99  | 39159-3717 | <b>326212</b> | <b>226.25</b> | L |
| STS              | 900  | 01-'02 | 39159-3725 | <b>326213</b> | <b>261.30</b> | L |
| STX              | 900  | 99-'06 | 39159-3732 | <b>326213</b> | <b>261.30</b> | L |
| STX              | 1100 | 97-99  | 39159-3732 | <b>326213</b> | <b>261.30</b> | L |
| STX DI           | 1100 | 00-'03 | 39159-3732 | <b>326213</b> | <b>261.30</b> | L |
| ZXi              | 1100 | 96-'03 | 39159-3724 | <b>326215</b> | <b>243.75</b> | L |
| ZXi              | 1100 | 96-'03 | 39159-3740 | <b>326215</b> | <b>243.75</b> | L |
| STX-12F          | 1200 | 03-'07 | 39159-3739 | <b>329567</b> | <b>319.95</b> | L |
| STX-R            | 1200 | 02-'05 | 39159-3725 | <b>326213</b> | <b>261.30</b> | L |
| STX-R            | 1200 | 02-'05 | 39159-3732 | <b>326213</b> | <b>261.30</b> | L |
| Ultra 150        | 1200 | 99-'05 | 39159-3730 | <b>326214</b> | <b>243.75</b> | L |
| STX              | 1500 | 09-'10 | 39159-3739 | <b>329567</b> | <b>319.95</b> | L |
| STX-15F          | 1500 | 05-'15 | 39159-3739 | <b>329567</b> | <b>319.95</b> | L |
| Ultra 250X       | 1500 | 07-'08 | 39159-3742 | <b>329016</b> | <b>283.82</b> | L |
| Ultra 260X       | 1500 | 09     | 39159-3742 | <b>329016</b> | <b>283.82</b> | L |
| Ultra 300LX      | 1500 | 11-'13 | 39159-3744 | <b>329568</b> | <b>324.95</b> | L |
| Ultra 300X       | 1500 | 11-'13 | 39159-3744 | <b>329568</b> | <b>324.95</b> | L |
| Ultra LX         | 1500 | 07-'15 | 39159-3739 | <b>329567</b> | <b>319.95</b> | L |
| <b>POLARIS</b>   |      |        |            |               |               |   |
| SL               | 650  | 92-95  | 6230066    | <b>326200</b> | <b>307.05</b> | A |
| SL STD           | 650  | 95     | 6230066    | <b>326200</b> | <b>307.05</b> | A |
| SL               | 750  | 93-95  | 6230066    | <b>326200</b> | <b>307.05</b> | A |
| SLT              | 750  | 94-95  | 6230066    | <b>326200</b> | <b>307.05</b> | A |
| SLT              | 700  | 96-97  | 6230103    | <b>326201</b> | <b>158.65</b> | L |
| SLH              | 700  | 98-'01 | 6230103    | <b>326201</b> | <b>158.65</b> | L |
| SLTH             | 700  | 98-'01 | 6230103    | <b>326201</b> | <b>158.65</b> | L |
| VIRAGE 3-PASS    | 700  | 95-96  | 6230103    | <b>326201</b> | <b>158.65</b> | L |
| SLT              | 780  | 96-97  | 6230103    | <b>326201</b> | <b>158.65</b> | L |
| SLX              | 780  | 00-'02 | 6230103    | <b>326201</b> | <b>158.65</b> | L |
| SL               | 900  | 96-97  | 6230103    | <b>326201</b> | <b>158.65</b> | L |
| SL               | 1050 | 97     | 6230103    | <b>326201</b> | <b>158.65</b> | L |
| SLTX             | 1050 | 96-99  | 6230103    | <b>326201</b> | <b>158.65</b> | L |
| SLX              | 1050 | 99     | 6230103    | <b>326201</b> | <b>158.65</b> | L |
| SLXH             | 1050 | 98     | 6230103    | <b>326201</b> | <b>158.65</b> | L |
| SLX 2-PASS       | 1165 | 00-'02 | 6230103    | <b>326201</b> | <b>158.65</b> | L |
| VIRAGE TX 3-PASS | 1165 | 01-'02 | 6230103    | <b>326201</b> | <b>158.65</b> | L |
| GENESIS          | 1165 | 99-'04 | 6230216    | <b>326202</b> | <b>176.95</b> | L |

- accessories
- towables
- body
- controls
- electrical
- driveline
- engine
- fuel & intake
- chemicals
- tie downs
- tools
- towing & loading

MARINE



## WSM DRIVE SHAFTS CONTINUED

| MODEL          | CC   | YEAR   | OEM #     | PART #        |               |   |
|----------------|------|--------|-----------|---------------|---------------|---|
| <b>SEA-DOO</b> |      |        |           |               |               |   |
| SPX            | 580  | 93     | 272000020 | <b>326195</b> | <b>156.10</b> | L |
| XP             | 580  | 91-92  | 272000065 | <b>326195</b> | <b>156.10</b> | L |
| GTX            | 650  | 94     | 272000065 | <b>326195</b> | <b>156.10</b> | L |
| GTX            | 650  | 95     | 272000055 | <b>326198</b> | <b>156.10</b> | L |
| SPX            | 650  | 94     | 272000020 | <b>326195</b> | <b>156.10</b> | L |
| SPX            | 650  | 94     | 272000065 | <b>326195</b> | <b>156.10</b> | L |
| SPX            | 650  | 95     | 272000055 | <b>326198</b> | <b>156.10</b> | L |
| XP             | 650  | 93-94  | 272000020 | <b>326195</b> | <b>156.10</b> | L |
| XPI            | 650  | 94     | 272000065 | <b>326195</b> | <b>156.10</b> | L |
| GS             | 720  | 97-'01 | 272000096 | <b>326197</b> | <b>156.10</b> | L |
| GSI            | 720  | 97     | 272000096 | <b>326197</b> | <b>156.10</b> | L |
| GTI            | 720  | 96     | 272000073 | <b>326199</b> | <b>156.65</b> | L |
| GTI            | 720  | 97     | 272000127 | <b>326220</b> | <b>156.10</b> | L |
| GTI            | 720  | 99-'00 | 272000127 | <b>326220</b> | <b>156.10</b> | L |
| GTI            | 720  | 01-'05 | 272000096 | <b>326197</b> | <b>156.10</b> | L |
| GTI LE         | 720  | 02-'04 | 272000096 | <b>326197</b> | <b>156.10</b> | L |
| GTS            | 720  | 97     | 272000127 | <b>326220</b> | <b>156.10</b> | L |
| GTS            | 720  | 97-'00 | 272000073 | <b>326199</b> | <b>156.65</b> | L |
| GTS            | 720  | 01     | 272000096 | <b>326197</b> | <b>156.10</b> | L |
| HX             | 720  | 95-97  | 272000009 | <b>326218</b> | <b>175.30</b> | L |
| HX             | 720  | 96     | 271001556 | <b>329015</b> | <b>211.05</b> | L |
| HX             | 720  | 96     | 272000079 | <b>329015</b> | <b>211.05</b> | L |
| SP             | 720  | 97     | 272000073 | <b>326199</b> | <b>156.65</b> | L |
| SPX            | 720  | 96     | 272000073 | <b>326199</b> | <b>156.65</b> | L |
| 3D RFI         | 800  | 05     | 272000150 | <b>326226</b> | <b>175.30</b> | L |
| 3D RFI         | 800  | 05     | 272000154 | <b>329013</b> | <b>217.02</b> | L |
| GSX            | 800  | 96-97  | 272000096 | <b>326197</b> | <b>156.10</b> | L |
| GSX RFI        | 800  | 99-'00 | 272000096 | <b>326197</b> | <b>156.10</b> | L |
| GTI LE RFI     | 800  | 03-'05 | 272000096 | <b>326197</b> | <b>156.10</b> | L |
| GTI RFI        | 800  | 04-'05 | 272000096 | <b>326197</b> | <b>156.10</b> | L |
| GTX            | 800  | 96     | 272000077 | <b>326223</b> | <b>156.10</b> | L |
| GTX            | 800  | 97     | 272000127 | <b>326220</b> | <b>156.10</b> | L |
| GTX RFI        | 800  | 98-'02 | 272000127 | <b>326220</b> | <b>156.10</b> | L |
| SPX            | 800  | 97-99  | 272000096 | <b>326197</b> | <b>156.10</b> | L |
| XP             | 800  | 95     | 272000062 | <b>326196</b> | <b>173.60</b> | L |
| XP             | 800  | 96     | 272000096 | <b>326197</b> | <b>156.10</b> | L |
| XP             | 800  | 97     | 272000107 | <b>329014</b> | <b>217.02</b> | L |
| XP             | 800  | 97     | 272000009 | <b>326218</b> | <b>175.30</b> | L |
| 3D DI          | 951  | 06-'07 | 272000154 | <b>329013</b> | <b>217.02</b> | L |
| GSX            | 951  | 98-99  | 272000151 | <b>326209</b> | <b>156.10</b> | L |
| GTX            | 951  | 00-'02 | 272000160 | <b>326225</b> | <b>156.10</b> | L |
| GTX DI         | 951  | 00-'03 | 272000160 | <b>326225</b> | <b>156.10</b> | L |
| GTX            | 951  | 98     | 272000160 | <b>326225</b> | <b>156.10</b> | L |
| LIMITED        |      |        |           |               |               |   |
| GTX LTD        | 951  | 99     | 272000160 | <b>326225</b> | <b>156.10</b> | L |
| LRV            | 951  | 00-'01 | 272000160 | <b>326225</b> | <b>156.10</b> | L |
| RX             | 951  | 00-'02 | 272000151 | <b>326209</b> | <b>156.10</b> | L |
| RX DI          | 951  | 00-'03 | 272000151 | <b>326209</b> | <b>156.10</b> | L |
| XP             | 951  | 00-'00 | 272000150 | <b>326226</b> | <b>175.30</b> | L |
| XP             | 951  | 00-'02 | 272000154 | <b>329013</b> | <b>217.02</b> | L |
| XP DI          | 951  | 03-'04 | 272000154 | <b>329013</b> | <b>217.02</b> | L |
| XP DI          | 951  | 03-'04 | 272000150 | <b>326226</b> | <b>175.30</b> | L |
| XP LTD         | 951  | 98-99  | 272000154 | <b>329013</b> | <b>217.02</b> | L |
| XP LTD         | 951  | 99     | 272000150 | <b>326226</b> | <b>175.30</b> | L |
| GTI            | 1503 | 06-'07 | 271001534 | <b>326205</b> | <b>245.45</b> | L |
| GTI / SE 130   | 1503 | 08     | 271001534 | <b>326205</b> | <b>245.45</b> | L |
| GTI / SE 130   | 1503 | 09-'10 | 271001623 | <b>326204</b> | <b>250.45</b> | L |
| GTI Rental     | 1503 | 06-'07 | 271001534 | <b>326205</b> | <b>245.45</b> | L |
| GTI Rental 130 | 1503 | 09-'10 | 271001623 | <b>326204</b> | <b>250.45</b> | L |
| GTI SE         | 1503 | 06-'07 | 271001534 | <b>326205</b> | <b>245.45</b> | L |
| GTI SE 155     | 1503 | 09-'10 | 271001623 | <b>326204</b> | <b>250.45</b> | L |
| GTI Wake 155   | 1503 | 09-'10 | 271001623 | <b>326204</b> | <b>250.45</b> | L |
| GTX            | 1503 | 02-'04 | 271001449 | <b>326203</b> | <b>243.75</b> | L |

- accessories
- towables
- body
- controls
- electrical
- driveline**
- engine
- fuel & intake
- chemicals
- tie downs
- tools
- towing & loading

# MARINE

## WSM DRIVE SHAFTS CONTINUED

| MODEL                    | CC   | YEAR   | OEM #           | PART #        |               |   |
|--------------------------|------|--------|-----------------|---------------|---------------|---|
| <b>SEA-DOO CONTINUED</b> |      |        |                 |               |               |   |
| GTX                      | 1503 | 02-'04 | 272000185       | <b>326203</b> | <b>243.75</b> | L |
| GTX                      | 1503 | 02-'04 | 272000186       | <b>326203</b> | <b>243.75</b> | L |
| GTX                      | 1503 | 06-'07 | 271001534       | <b>326205</b> | <b>245.45</b> | L |
| GTX 155                  | 1503 | 09     | 271001623       | <b>326204</b> | <b>250.45</b> | L |
| GTX LTD S.C. 185         | 1503 | 03-'04 | 271001449       | <b>326203</b> | <b>243.75</b> | L |
| GTX LTD S.C. 185         | 1503 | 03-'04 | 272000185       | <b>326203</b> | <b>243.75</b> | L |
| GTX LTD S.C. 185         | 1503 | 03-'04 | 272000186       | <b>326203</b> | <b>243.75</b> | L |
| GTX LTD S.C. 215         | 1503 | 06-'08 | 271001550       | <b>326207</b> | <b>245.45</b> | L |
| GTX S.C. 185             | 1503 | 03-'04 | 271001449       | <b>326203</b> | <b>243.75</b> | L |
| GTX S.C. 185             | 1503 | 03-'04 | 272000185       | <b>326203</b> | <b>243.75</b> | L |
| GTX S.C. 185             | 1503 | 03-'04 | 272000186       | <b>326203</b> | <b>243.75</b> | L |
| GTX S.C. 185             | 1503 | 06     | 271001534       | <b>326205</b> | <b>245.45</b> | L |
| GTX S.C. 215             | 1503 | 08     | 271001550       | <b>326207</b> | <b>245.45</b> | L |
| GTX Wake                 | 1503 | 03-'04 | 271001449       | <b>326203</b> | <b>243.75</b> | L |
| GTX Wake                 | 1503 | 03-'04 | 272000185       | <b>326203</b> | <b>243.75</b> | L |
| GTX Wake                 | 1503 | 03-'04 | 272000186       | <b>326203</b> | <b>243.75</b> | L |
| GTX Wake                 | 1503 | 06-'08 | 271001534       | <b>326205</b> | <b>245.45</b> | L |
| GTX Wake S.C. 215        | 1503 | 07     | 271001550       | <b>326207</b> | <b>245.45</b> | L |
| GTX Wake S.C. 215        | 1503 | 08     | 271001534       | <b>326205</b> | <b>245.45</b> | L |
| RXP S.C. 215             | 1503 | 04-'09 | 271001432       | <b>326206</b> | <b>245.45</b> | L |
| RXP S.C. 215             | 1503 | 04-'09 | 271001601       | <b>326206</b> | <b>245.45</b> | L |
| RXP S.C. 215             | 1503 | 07-'08 | 271001564       | <b>329569</b> | <b>199.95</b> | L |
| RXP X 255                | 1503 | 08-'11 | 271001432       | <b>326206</b> | <b>245.45</b> | L |
| RXP X 255                | 1503 | 08-'11 | 271001601       | <b>326206</b> | <b>245.45</b> | L |
| RXP X 255                | 1503 | 09-'10 | 271001636       | <b>326208</b> | <b>267.15</b> | L |
| RXT S.C. 215             | 1503 | 06-'08 | 271001550       | <b>326207</b> | <b>245.45</b> | L |
| RXT X 255                | 1503 | 08-'09 | 271001585       | <b>329570</b> | <b>293.90</b> | L |
| <b>TIGER SHARK</b>       |      |        |                 |               |               |   |
| DAYTONA                  | 640  | 93     | 0673-041        | <b>326241</b> | <b>232.15</b> | L |
| TIGERSHARK               | 640  | 93     | 0673-041        | <b>326241</b> | <b>232.15</b> | L |
| BARRACUDA                | 640  | 94-95  | 0673-363        | <b>326240</b> | <b>232.15</b> | L |
| DAYTONA                  | 640  | 94-95  | 0673-363        | <b>326240</b> | <b>232.15</b> | L |
| MONTE CARLO              | 640  | 94-95  | 0673-363        | <b>326240</b> | <b>232.15</b> | L |
| MONTEGO DLX              | 640  | 94-95  | 0673-363        | <b>326240</b> | <b>232.15</b> | L |
| Monte Carlo              | 650  | 96     | 0673-363        | <b>326240</b> | <b>232.15</b> | L |
| Montego                  | 650  | 96     | 0673-363        | <b>326240</b> | <b>232.15</b> | L |
| Montego Deluxe           | 650  | 96     | 0673-363        | <b>326240</b> | <b>232.15</b> | L |
| Daytona                  | 770  | 96     | 0673-363        | <b>326240</b> | <b>232.15</b> | L |
| <b>YAMAHA</b>            |      |        |                 |               |               |   |
| Super Jet                | 650  | 90-93  | 6R7-45511-00-00 | <b>326228</b> | <b>257.10</b> | L |
| VXR                      | 650  | 91-95  | 61L-45511-00-00 | <b>326229</b> | <b>263.80</b> | L |
| Wave Runner III          | 650  | 90-93  | 6R8-45511-00    | <b>326231</b> | <b>280.50</b> | L |
| Wave Runner III          | 650  | 95-96  | 6R8-45511-00    | <b>326231</b> | <b>280.50</b> | L |
| Super Jet                | 700  | 95-'07 | 6R7-45511-00-00 | <b>326228</b> | <b>257.10</b> | L |
| Wave Blaster             | 700  | 93-96  | 62E-45511-00-00 | <b>326230</b> | <b>253.80</b> | L |
| Wave Raider              | 700  | 94-97  | 6R8-45511-00    | <b>326231</b> | <b>280.50</b> | L |
| Wave Runner III          | 700  | 94-95  | 6R8-45511-00    | <b>326231</b> | <b>280.50</b> | L |
| Wave Venture             | 700  | 96     | 6R8-45511-00    | <b>326231</b> | <b>280.50</b> | L |
| Wave Venture             | 700  | 98     | 65R-45511-00    | <b>326232</b> | <b>257.10</b> | L |
| XL                       | 700  | 99-'03 | 65R-45511-00    | <b>326232</b> | <b>257.10</b> | L |
| Wave Blaster             | 760  | 96-97  | 64Y-45511-00    | <b>326233</b> | <b>208.70</b> | L |
| Wave Raider              | 760  | 96     | 6R8-45511-00    | <b>326231</b> | <b>280.50</b> | L |
| Wave Venture             | 760  | 97     | 65R-45511-00    | <b>326232</b> | <b>257.10</b> | L |
| XL                       | 760  | 98-99  | 65R-45511-00    | <b>326232</b> | <b>257.10</b> | L |
| GP                       | 800  | 98     | 66E-45511-00-00 | <b>326237</b> | <b>262.15</b> | L |
| GP                       | 800  | 01     | 66V-45511-00-00 | <b>326235</b> | <b>225.40</b> | L |
| GP                       | 800  | 01     | 66V-45511-01-00 | <b>326235</b> | <b>225.40</b> | L |
| GP                       | 800  | 02     | 68Y-45511-00-00 | <b>326238</b> | <b>267.15</b> | L |
| GP-R                     | 800  | 03-'05 | 68Y-45511-01-00 | <b>326238</b> | <b>267.15</b> | L |
| XL                       | 800  | 00-'01 | 66V-45511-00-00 | <b>326235</b> | <b>225.40</b> | L |
| XL                       | 800  | 00-'01 | 66V-45511-01-00 | <b>326235</b> | <b>225.40</b> | L |

- accessories
- towables
- body
- controls
- electrical
- driveline**
- engine
- fuel & intake
- chemicals
- tie downs
- tools
- towing & loading

## WSM DRIVE SHAFTS CONTINUED

| MODEL                   | CC   | YEAR   | OEM #           | PART #        |               |   |
|-------------------------|------|--------|-----------------|---------------|---------------|---|
| <b>YAMAHA CONTINUED</b> |      |        |                 |               |               |   |
| XLT                     | 800  | 02-'04 | 68Y-45511-00-00 | <b>326238</b> | <b>267.15</b> | L |
| FX                      | 1000 | 05-'08 | 68Y-45511-01-00 | <b>326238</b> | <b>267.15</b> | L |
| FX 140                  | 1000 | 02-'04 | 68Y-45511-01-00 | <b>326238</b> | <b>267.15</b> | L |
| FX Cruiser              | 1000 | 03-'08 | 68Y-45511-01-00 | <b>326238</b> | <b>267.15</b> | L |
| FX Cruiser HO           | 1100 | 04-'08 | 68Y-45511-01-00 | <b>326238</b> | <b>267.15</b> | L |
| FX HO                   | 1100 | 04-'08 | 68Y-45511-01-00 | <b>326238</b> | <b>267.15</b> | L |
| V1                      | 1100 | 15     | 6BU-45511-00-00 | <b>329571</b> | <b>249.95</b> | L |
| V1 Sport                | 1100 | 15     | 6BU-45511-00-00 | <b>329571</b> | <b>249.95</b> | L |
| VX                      | 1100 | 07-'09 | 6D3-45511-00-00 | <b>329572</b> | <b>248.75</b> | L |
| VX Cruiser              | 1100 | 07-'09 | 6D3-45511-00-00 | <b>329572</b> | <b>248.75</b> | L |
| VX Cruiser              | 1100 | 10-'15 | 6BU-45511-00-00 | <b>329571</b> | <b>249.95</b> | L |
| VX Deluxe               | 1100 | 05-'09 | 6D3-45511-00-00 | <b>329572</b> | <b>248.75</b> | L |
| VX Deluxe               | 1100 | 10-'15 | 6BU-45511-00-00 | <b>329571</b> | <b>249.95</b> | L |
| VX Sport                | 1100 | 05-'09 | 6D3-45511-00-00 | <b>329572</b> | <b>248.75</b> | L |
| VX Sport                | 1100 | 10-'13 | 6BU-45511-00-00 | <b>329571</b> | <b>249.95</b> | L |
| Wave Raider             | 1100 | 95-96  | 63M-45511-00-00 | <b>326234</b> | <b>280.50</b> | L |
| Wave Venture            | 1100 | 96-97  | 63M-45511-00-00 | <b>326234</b> | <b>280.50</b> | L |
| GP                      | 1200 | 97-99  | 65U-45511-00    | <b>326236</b> | <b>220.40</b> | L |
| GP                      | 1200 | 02     | 68Y-45511-00-00 | <b>326238</b> | <b>267.15</b> | L |
| GP                      | 1200 | 02     | 68Y-45511-01-00 | <b>326238</b> | <b>267.15</b> | L |
| GP-R                    | 1200 | 00-'01 | 66V-45511-00-00 | <b>326235</b> | <b>225.40</b> | L |
| SUV                     | 1200 | 99-'01 | 66V-45511-01-00 | <b>326235</b> | <b>225.40</b> | L |
| SUV                     | 1200 | 02-'04 | 68Y-45511-00-00 | <b>326238</b> | <b>267.15</b> | L |
| SUV                     | 1200 | 02-'04 | 68Y-45511-01-00 | <b>326238</b> | <b>267.15</b> | L |
| XL                      | 1200 | 98     | 65U-45511-00    | <b>326236</b> | <b>220.40</b> | L |
| XL LTD                  | 1200 | 99-'00 | 66V-45511-00-00 | <b>326235</b> | <b>225.40</b> | L |
| XL LTD                  | 1200 | 99-'00 | 66V-45511-01-00 | <b>326235</b> | <b>225.40</b> | L |
| XLT                     | 1200 | 01-'05 | 68Y-45511-00-00 | <b>326238</b> | <b>267.15</b> | L |
| XLT                     | 1200 | 01-'05 | 68Y-45511-01-00 | <b>326238</b> | <b>267.15</b> | L |
| GP-R                    | 1300 | 03-'08 | 66V-45511-00-00 | <b>326235</b> | <b>225.40</b> | L |
| GP-R                    | 1300 | 03-'08 | 66V-45511-01-00 | <b>326235</b> | <b>225.40</b> | L |
| FX Cruiser HO           | 1800 | 09-'15 | 6S5-45511-00-00 | <b>329017</b> | <b>283.82</b> | L |
| FX Cruiser SHO          | 1800 | 08-'15 | 6S5-45511-00-00 | <b>329017</b> | <b>283.82</b> | L |
| FX HO                   | 1800 | 09-'15 | 6S5-45511-00-00 | <b>329017</b> | <b>283.82</b> | L |
| FX SHO                  | 1800 | 08-'15 | 6S5-45511-00-00 | <b>329017</b> | <b>283.82</b> | L |
| FZR                     | 1800 | 09-'15 | 6AN-45511-00-00 | <b>329212</b> | <b>283.82</b> | L |
| FZS                     | 1800 | 09-'15 | 6AN-45511-00-00 | <b>329212</b> | <b>283.82</b> | L |
| VXR                     | 1800 | 11-'14 | 6S5-45511-00-00 | <b>329017</b> | <b>283.82</b> | L |
| VXS                     | 1800 | 11-'14 | 6S5-45511-00-00 | <b>329017</b> | <b>283.82</b> | L |

- accessories
- towables
- body
- controls
- electrical
- driveline**
- engine
- fuel & intake
- chemicals
- tie downs
- tools
- towing & loading

# MARINE

## WSM COUPLERS

- accessories
- towables
- body
- controls
- electrical
- driveline**
- engine
- fuel & intake
- chemicals
- tie downs
- tools
- towing & loading

| MODEL             | YEAR  | O.E.M #    | MFG #   | OUTSIDE DIA. | THREAD SIZE | PART #        |              |   |
|-------------------|-------|------------|---------|--------------|-------------|---------------|--------------|---|
| <b>KAWASAKI</b>   |       |            |         |              |             |               |              |   |
| 440 SX            | 77-92 | 42034-3706 | 003-211 | 85MM         | 17MM        | <b>326252</b> | <b>17.10</b> | L |
| 550 SX            | 82-89 | 42034-3706 | 003-211 | 85MM         | 17MM        | <b>326252</b> | <b>17.10</b> | L |
| 550 SX            | 90-95 | 42034-3706 | 003-210 | 85MM         | 18MM        | <b>326251</b> | <b>23.80</b> | L |
| 650               | ALL   | 42034-3706 | 003-210 | 85MM         | 18MM        | <b>326251</b> | <b>23.80</b> | L |
| 750               | 92-93 | 42034-3706 | 003-210 | 85MM         | 18MM        | <b>326251</b> | <b>23.80</b> | L |
| 750 XI            | 94    | 42034-3706 | 003-210 | 85MM         | 18MM        | <b>326251</b> | <b>23.80</b> | L |
| 750/800           | 94-UP | 42034-3707 | 003-212 | 85MM         | 20MM        | <b>326253</b> | <b>23.30</b> | L |
| 900STX            | 97-98 | 42034-3708 | 003-213 | 85MM         | 24MM        | <b>326254</b> | <b>23.30</b> | L |
| ZXI               | 95-97 | 42034-3708 | 003-213 | 85MM         | 24MM        | <b>326254</b> | <b>23.30</b> | L |
| 900               | ALL   | 42034-3709 | 003-214 | 100MM        | 24MM        | <b>326255</b> | <b>23.80</b> | L |
| 1100              | ALL   | 42034-3709 | 003-214 | 100MM        | 24MM        | <b>326255</b> | <b>23.80</b> | L |
| 1200              | ALL   | 42034-3709 | 003-214 | 100MM        | 24MM        | <b>326255</b> | <b>23.80</b> | L |
| 12F/15F           | ALL   | 42034-3711 | 003-225 | 109MM        | 23MM        | <b>326266</b> | <b>26.65</b> | L |
| ULTRA 150/250/260 | ALL   | 42034-371  | 003-225 | 109MM        | 23MM        | <b>326266</b> | <b>26.65</b> | L |

| MODEL          | YEAR  | O.E.M #     | MFG #      | POSITION    | PART #        |               |   |
|----------------|-------|-------------|------------|-------------|---------------|---------------|---|
| <b>SEA-DOO</b> |       |             |            |             |               |               |   |
| 720 HX         | 95-97 | 272-000-046 | 003-239    | MID-SHAFT   | <b>326267</b> | <b>73.40</b>  | L |
| 800XP          | 97    | 272-000-046 | 003-239    | MID-SHAFT   | <b>326267</b> | <b>73.40</b>  | L |
| 800XP          | 97    | 290-958-096 | 003-239-01 | ENGINE PTO  | <b>329018</b> | <b>109.95</b> | L |
| 951 XP LIMITED | 98    | 290-958-130 | 003-239-02 | ENGINE PTO  | <b>329019</b> | <b>73.95</b>  | H |
| XP             | 99-05 |             |            | DRIVE SHAFT | <b>329214</b> | <b>83.42</b>  | L |
| 951 XP         | 00-01 |             |            | DRIVE SHAFT | <b>329214</b> | <b>83.42</b>  | L |
| 800 RFI        | 05    | 272-000-158 | 003-240    | DRIVE SHAFT | <b>326268</b> | <b>66.75</b>  | L |
| 951            | 99-07 | 272-000-158 | 003-240    | DRIVE SHAFT | <b>326268</b> | <b>66.75</b>  | L |



| CONFIGURATION                | THREAD SIZE | FINGERS | O.E.M. # | MFG #           | PART #  |               |                |
|------------------------------|-------------|---------|----------|-----------------|---------|---------------|----------------|
| <b>YAMAHA</b>                |             |         |          |                 |         |               |                |
| 500 C.C.                     |             | 20MM    | 3        | 6K8-45813-10-9M | 003-215 | <b>326256</b> | <b>33.25</b> L |
| 650C.C                       |             | 20MM    | 3        | 6M6-45813-00-9M | 003-217 | <b>326258</b> | <b>33.25</b> L |
| COUPLER SHAFT                |             | 24MM    | 3        | 6R7-45813-11-CA | 003-219 | <b>326260</b> | <b>33.25</b> L |
| CRANK SHAFT                  |             | 27MM    | 3        | 6M6-45813-32-8P | 003-220 | <b>326261</b> | <b>36.85</b> L |
| CURVED FINGERS (OLD STYLE)   |             | 24MM    | 5        | 64T-45813-01-8P | 003-222 | <b>326263</b> | <b>32.45</b> L |
| CURVED FINGERS (OLD STYLE)   |             | 27MM    | 5        | 63M-45813-01-9M | 003-221 | <b>326262</b> | <b>33.25</b> L |
| STRAIGHT FINGERS (NEW STYLE) |             | 24MM    | 5        | 68N-45593-00-94 | 003-224 | <b>326265</b> | <b>33.25</b> L |
| STRAIGHT FINGERS (NEW STYLE) |             | 27MM    | 5        | 66E-45813-10-94 | 003-223 | <b>326264</b> | <b>33.25</b> L |

## WSM RUBBER DAMPENERS

| MAKE/MODEL                       | YEAR  | O.E.M. #     | PART #        |              |   |
|----------------------------------|-------|--------------|---------------|--------------|---|
| <b>KAWASAKI</b>                  |       |              |               |              |   |
| 440/550/650/750/900              |       |              | <b>326242</b> | <b>16.70</b> | L |
| 900/1100/1200                    |       |              | <b>326249</b> | <b>22.75</b> | L |
| ULTRA 150/250/260/12F/15F        |       | 92160-3711   | <b>326250</b> | <b>22.75</b> | L |
| <b>SEA-DOO</b>                   |       |              |               |              |   |
| HX                               | 95-99 | 293-830-026  | <b>326243</b> | <b>33.35</b> | L |
| XP DI                            | 03-04 | 293-830-067  | <b>326244</b> | <b>11.30</b> | L |
| XP                               | 00-02 | 293-830-067  | <b>326244</b> | <b>11.30</b> | L |
| <b>YAMAHA</b>                    |       |              |               |              |   |
| 500                              | ALL   | 6K8-4581J-00 | <b>326246</b> | <b>12.20</b> | L |
| 3 FINGER COUPLER                 | ALL   | 6M6-4581J-00 | <b>326247</b> | <b>13.95</b> | L |
| 5 FINGER COUPLER STRAIGHT FINGER |       | 66E-4581J-00 | <b>326245</b> | <b>24.40</b> | L |
| 5 FINGER COUPLER CURVED FINGER   |       | 663-4581J-00 | <b>326248</b> | <b>13.95</b> | L |





## WSM COUPLER SHAFTS



| MODEL           | CC  | YEAR   | OEM #   | PART #        |
|-----------------|-----|--------|---|---------------|
| <b>YAMAHA</b>   |     |        |   |               |
| Super Jet       | 650 | 90-93  | 62E-51323-00-00<br>6R7-51323-00-00<br>6R7-51323-01-00<br>6R7-51323-02-00                    | <b>326269</b> |
| VXR             | 650 | 91-93  | 61L-51323-01-00   | <b>326273</b> |
| VXR             | 650 | 95     | 6R7-51323-00-00<br>62E-51323-00-00<br>6R7-51323-01-00<br>6R7-51323-02-00                    | <b>326269</b> |
| Wave Runner III | 650 | 90-93  | 6R8-51323-00-00   | <b>326277</b> |
| Wave Runner III | 650 | 95-96  | 6R8-51323-03-00<br>6R8-51323-01-00<br>6R8-51323-02-00<br>6R8-51323-10-00                    |               |
| Super Jet       | 700 | 95-'15 | 6R7-51323-01-00   |               |
| Wave Blaster    | 700 | 93-96  | 6R7-51323-02-00<br>62E-51323-00-00<br>6R7-51323-00-00                                       | <b>326269</b> |
| Wave Raider     | 700 | 94-97  | 6R8-51323-01-00   | <b>326277</b> |
| Wave Runner III | 700 | 94-95  | 6R8-51323-02-00   |               |
| Wave Runner III | 700 | 97     | 6R8-51323-10-00<br>6R8-51323-00-00<br>6R8-51323-03-00                                       |               |
| Wave Venture    | 700 | 95-96  | 63N-51323-00-00   | <b>326270</b> |
| Wave Venture    | 700 | 98     | 63N-51323-10-00   |               |
| XL              | 700 | 99-'04 |   |               |
| GP              | 760 | 99-'00 | 65V-51323-00-00   | <b>326276</b> |
| Wave Raider     | 760 | 96     | 6R8-51323-00-00<br>6R8-51323-01-00<br>6R8-51323-02-00<br>6R8-51323-03-00<br>6R8-51323-10-00 | <b>326277</b> |
| Wave Runner     | 760 | 97-98  | 65V-51323-00-00   | <b>326276</b> |
| Wave Venture    | 760 | 97     | 63N-51323-00-00   | <b>326270</b> |
| XL              | 760 | 98-99  | 63N-51323-10-00   |               |

| MODEL                   | CC   | YEAR    | OEM #                              | PART #        |
|-------------------------|------|---------|------------------------------------|---------------|
| <b>YAMAHA CONTINUED</b> |      |         |                                    |               |
| GP                      | 800  | 98      | 63M-51323-00-00<br>63M-51323-01-00 | <b>326271</b> |
| GP                      | 800  | 01      | 66V-51323-00-00<br>66V-51323-01-00 | <b>326272</b> |
| GP                      | 800  | 02-'05  | 68N-51323-00-00                    | <b>326274</b> |
| Wave Runner             | 800  | 04      |                                    |               |
| XL                      | 800  | 00-'01  | 66V-51323-01-00<br>66V-51323-00-00 | <b>326272</b> |
| XLT                     | 800  | 02-'04  | 68N-51323-00-00                    | <b>326274</b> |
| FX 140                  | 1000 | '02-'08 | 60E-51323-00-00                    | <b>326278</b> |
| Wave Raider             | 1100 | 95-96   | 63M-51323-01-00                    | <b>326271</b> |
| Wave Venture            | 1100 | 96-97   | 63M-51323-00-00                    |               |
| GP                      | 1200 | 97-99   |                                    |               |
| GP                      | 1200 | 00-01   | 66V-51323-00-00<br>66V-51323-01-00 | <b>326272</b> |
| GP                      | 1200 | 02      | 68N-51323-00-00                    | <b>326274</b> |
| SUV                     | 1200 | 03      | 66V-51323-00-00<br>66V-51323-01-00 | <b>326272</b> |
| SV                      | 1200 | 02-04   | 68N-51323-00-00                    | <b>326274</b> |
| XL                      | 1200 | 98      | 63M-51323-00-00                    | <b>326271</b> |
| XL                      | 1200 | 99-'00  | 66V-51323-00-00<br>66V-51323-01-00 | <b>326272</b> |
| XL                      | 1200 | 01      | 68N-51323-00-00                    | <b>326274</b> |
| XLT                     | 1200 | 02-'05  |                                    |               |
| GPR                     | 1300 | 03-'08  |                                    |               |
| FX Cruiser HO           | 1800 | 09-'15  | 6S5-51323-00-00                    | <b>329022</b> |
| FX Cruiser SHO          | 1800 | 08-'15  |                                    |               |
| FX HO                   | 1800 | 09-'11  |                                    |               |
| FX SHO                  | 1800 | 08-'12  |                                    |               |
| FZR                     | 1800 | 09-'15  |                                    |               |
| FZS                     | 1800 | 09-'15  |                                    |               |
| VXR                     | 1800 | 11-'14  |                                    |               |
| VXS                     | 1800 | 11-'14  |                                    |               |

## COUPLER SHAFTS PRICING

|               |               |          |               |               |          |
|---------------|---------------|----------|---------------|---------------|----------|
| <b>326269</b> | <b>122.70</b> | <b>L</b> | <b>326274</b> | <b>191.15</b> | <b>L</b> |
| <b>326270</b> | <b>183.65</b> | <b>L</b> | <b>326276</b> | <b>165.00</b> | <b>L</b> |
| <b>326271</b> | <b>127.95</b> | <b>L</b> | <b>326277</b> | <b>163.40</b> | <b>L</b> |
| <b>326272</b> | <b>212.05</b> | <b>L</b> | <b>326278</b> | <b>200.35</b> | <b>L</b> |
| <b>326273</b> | <b>140.20</b> | <b>L</b> | <b>329022</b> | <b>200.32</b> | <b>L</b> |

- accessories
- towables
- body
- controls
- electrical
- driveline
- engine
- fuel & intake
- chemicals
- tie downs
- tools
- towing & loading

# MARINE

## SEA-DOO WEAR RINGS



- accessories
- towables
- body
- controls
- electrical
- driveline**
- engine
- fuel & intake
- chemicals
- tie downs
- tools
- towing & loading

|               |  |          |
|---------------|--|----------|
| <b>121302</b> | <b>34.95</b>                                   | <b>L</b> |
| OEM#          | 271-000-290 / 271-000-101                      |          |
| MODEL:        | SEA-DOO  |          |
| DESCRIPTION:  | WEAR RING                                      |          |
| SPEC:         | I.D 140.3 X O.D 158.9 X H 68.3 / 70.2MM. W/LIP |          |
| PACKING:      | 1PC/POLYBAG                                    |          |
| MATERIAL:     | POM (DELTRIN)                                  |          |



|               |   |          |
|---------------|---|----------|
| <b>121304</b> | <b>34.95</b>  | <b>L</b> |
| OEM#          | 267-000-104 / 267-000-419 / 267-000-021 / 271-001-236 |          |
| MODEL:        | SEA-DOO   |          |
| DESCRIPTION:  | WEAR RING   |          |
| SPEC:         | I.D 157.6 X O.D 171.6 X H 78.2MM.                     |          |
| MATERIAL:     | POM (DELTRIN)   |          |
| PACKING:      | 1PC/POLYBAG   |          |



|               |                                |          |
|---------------|--------------------------------|----------|
| <b>121303</b> | <b>38.95</b>                   | <b>L</b> |
| OEM#          | 267-000-105 / 267-000-372      |          |
| MODEL:        | SEA-DOO                        |          |
| DESCRIPTION:  | WEAR RING                      |          |
| SPEC:         | I.D 162 X O.D 172.6 X H 78.2MM |          |
| PACKING:      | 1PC/POLYBAG                    |          |
| MATERIAL:     | POM (DELTRIN)                  |          |



|               |                                   |          |
|---------------|-----------------------------------|----------|
| <b>121305</b> | <b>34.95</b>                      | <b>L</b> |
| OEM#          | 271-000-653                       |          |
| MODEL:        | SEA-DOO                           |          |
| DESCRIPTION:  | WEAR RING                         |          |
| SPEC:         | I.D 156.3 X O.D 170.3 X H 68.5MM. |          |
| MATERIAL:     | POM (DELTRIN)                     |          |
| PACKING:      | 1PC/POLYBAG                       |          |



| FITS SEA-DOO MODEL       | YEAR  | OEM #                           | PART #                |
|--------------------------|-------|---------------------------------|-----------------------|
| 580 / 650 / 720          | 95-98 | 271000290 003-500<br>(140mm ID) | <b>326307</b> 38.60 L |
| 800 Carb                 | 95-98 |                                 |                       |
| 800 RFI                  | 99-02 |                                 |                       |
| 4-Tec 130 / 155 / 185 HP | 04-12 | 267-000-104<br>(155.5 mm ID)    | <b>326309</b> 40.00 L |
| 4-Tec 215 / 255 / 260 HP | 04-13 | 267000105<br>(159mm ID)         | <b>326305</b>         |
| 720                      | 99-05 | 271000653                       | <b>326311</b> 38.60 L |
| 800 RFI                  | 03-05 |                                 |                       |
| 951 / 4-Tec              | 02-03 |                                 |                       |





# ENGINE



## FORGED POWERSPORTS PISTONS

### Powersports Forged Piston Advantage

Wiseco leads the performance aftermarket by producing the highest quality forged pistons for Dirt Bikes, ATV's, Snowmobiles, Outboard Marine, and Motorcycles right here in the USA. Wiseco is unique because we forge all of our own pistons in house, and produce all of our own forge tooling right here in the USA. This allows us to control all aspects of our manufacturing process from raw bar to skirt coating finished parts.

In addition, in-house dyno testing gives Wiseco the ability to develop state-of-the-art technology such as new shapes, coatings, and components, and lead the industry through rigorous R&D. Linking all segments of Wiseco's organization through design, testing, manufacturing, and distribution allows us to fulfill market needs with minimum lead-times.

Extreme racing conditions demand the strength and toughness that only forged pistons can offer. Compared to cast pistons, forgings are tougher and more durable, and will stand up to the abuse that high performance motorsport applications require. Most castings are brittle, have no grain structure and tend to fail catastrophically when the material yield strength is exceeded. Forgings have condensed grain that is aligned to the features of the part, which produces higher mechanical properties, and resistance to impact and fatigue. Each forging is designed to optimize the strength-to-weight ratio, and maximize performance.



### Piston Engineering / ArmorGlide Coating

Wiseco's detailed skirt shapes and profiles are very specific to each application. Variable cam programming software developed in house allows Wiseco to produce high-performance shapes unique to only Wiseco. The skirt shape (barrel/cam) is one of the most functional areas on the piston, and provides stability and smooth operation in the cylinder bore. Stability is important for proper ring seal, reduced friction, and quiet operation. Each skirt shape is designed for a specific running clearance, based on coefficient of thermal expansion of the piston alloy. Some

forging alloys expand more than casting alloys, but each Wiseco piston is designed with the proper installed clearance to produce the most power, least wear, and best seal at running temperature, for each application. Comparing installed clearances on cast vs forged parts is not indicative of the running clearance at temperature. Wiseco engineers have a strong background in all forms of racing applications, and produce the best shapes and designs in the industry.

Some of our forged pistons offer our new ArmorGlide™ skirt coating, which is the result of testing, development, and benchmarking through Wiseco's rigorous in-house dyno program. The outcome is the ultimate in skirt coating toughness, lubrication, and bond technology working together to minimize friction, maximize horsepower, and provide improved wear resistance. Not only is ArmorGlide™ a high-tech lubricant that reduces friction, but it also allows the piston to be fitted tighter within the bore allowing a better ring seal and reduced noise from piston rock.

### Top End Piston Kits

Wiseco's complete top end Piston Kits are offered for nearly every popular application in the powersports market. These kits contain everything you need to complete your rebuild the right way, the first time. High quality parts specifically chosen by us to match our forged pistons are included in this kit for easy one stop shopping.

- 2-stroke kits feature our Pro-Lite™ pistons that are CNC machined for optimal cam shape and profile for peak HP and service life.
- 4-stroke kits feature a 'race-ready' dome finish with smooth edges for improved combustion flow. Horizontal slot-pin oiling reduces friction and provides scuff resistance, along with a pressure seal groove for maximum ring seal.
- Most PK/SK/WK/VT kits from Wiseco feature a complete top end gasket kit that gives you everything you need to complete your rebuild from premium materials.
- 4-stroke race applications feature Wiseco's ArmorGlide™ skirt coating to provide reduced friction and noise to contribute to increased horsepower.
- Dedicated forgings used for superior strength to weight ratio utilizing aerospace alloy.
- High Performance ring kit and alloy pin included with each piston kit for extended life and sustained power.



- accessories
- towables
- body
- controls
- electrical
- driveline
- engine**
- fuel & intake
- chemicals
- tie downs
- tools
- towing & loading





## PERSONAL WATERCRAFT PISTONS AND GASKET SETS



| MODEL  | YEARS | STOCK ENGINE BORE X STROKE | DISP.  | BORE SIZE | TOP END KIT | SINGLE PISTON | RING SET | PISTON PIN | CIRCLIP | TOP END GASKET KIT | TOP END BRG | BOTTOM END GASKET KIT | MAIN SEAL KIT | MAIN BEARING /KIT |
|--|-------|----------------------------|--------|-----------|-------------|---------------|----------|------------|---------|--------------------|-------------|-----------------------|---------------|-------------------|
| <b>ARCTIC CAT - 2 STROKE</b>                         |       |                            |        |           |             |               |          |            |         |                    |             |                       |               |                   |
| 650cc Twin Cylinder                                  |       | 76.0                       | 639.0  | 76.0      | 102280      | 102449        | 2992TD   | S461       | CW20    | 101556             | B1024       |                       |               |                   |
| Barracuda 640  | 94-95 | x                          | 652.0  | 76.5      | 102281      | 102450        | 3012TD   |            |         |                    |             |                       |               |                   |
| Daytona 640  | 93-95 | 71.0                       | 661.0  | 77.0      | 102282      | 102451        | 3032TD   |            |         |                    |             |                       |               |                   |
| Monte Carlo 640                                      | 94-97 |                            |        |           |             |               |          |            |         |                    |             |                       |               |                   |
| Montego 640  | 94-97 |                            |        |           |             |               |          |            |         |                    |             |                       |               |                   |
| Montego Deluxe 640                                   | 94-97 |                            |        |           |             |               |          |            |         |                    |             |                       |               |                   |
| Tigershark 640                                       | 93    |                            |        |           |             |               |          |            |         |                    |             |                       |               |                   |
| TS / TSL 640   | 98-99 |                            |        |           |             |               |          |            |         |                    |             |                       |               |                   |
| 900cc Triple Cylinder                                |       | 76.5                       | 896.0  | 76.5      | 102951      | 2349M07650    | 3012TDW  | S512       | CW20    | 103411             | B1024       |                       |               |                   |
| Monte Carlo 900                                      | 96    | x                          | 998.0  | 80.5      |             | 2349M08050    | 3169TD   |            |         |                    |             |                       |               |                   |
| Tigershark 900                                       | 95    | 65.0                       |        |           |             |               |          |            |         |                    |             |                       |               |                   |
| 1000cc Triple Cylinder                               |       | 81.0                       | 1000.0 | 81.0      | 103083      | 2394M08100    | 3189KD   | S539       | CW22    | 103411             |             |                       |               |                   |
| Daytona 1000 1997                                    | 97    | x                          | 1100.0 | 85.0      | 103081      | 718M08500     | 3347KD   |            |         |                    |             |                       |               |                   |
| Monte Carlo 1000 1997                                | 97    | 64.6                       |        |           |             |               |          |            |         |                    |             |                       |               |                   |
| <b>KAWASAKI - 2 STROKE</b>                           |       |                            |        |           |             |               |          |            |         |                    |             |                       |               |                   |
| 300cc Single Cylinder                                |       | 76.0                       | 295.0  | 76.0      | 101898      | 102347        | 2992TD   | S513       | CW18    | 100866             | B1022       |                       |               |                   |
| 300 SX   | 87-91 | x                          | 299.0  | 76.5      | 101899      | 102348        | 3012TD   |            |         |                    |             |                       |               |                   |
| JS300  | 86-88 | 64.9                       | 303.0  | 77.0      | 101900      | 102349        | 3032TD   |            |         |                    |             |                       |               |                   |
|  |       |                            | 307.0  | 77.5      | 102947      | 103423        | 3051TD   |            |         |                    |             |                       |               |                   |
|  |       |                            | 311.0  | 78.0      | 102948      | 103424        | 3071TD   |            |         |                    |             |                       |               |                   |
| 440cc Twin Cylinder                                  |       | 68.0                       | 439.0  | 68.5      | 101553      | 2084M06850    | 2697CD   | S259       | CW16    | 102976             | B1021       |                       |               |                   |
| JS440  | 76-92 | x                          | 442.0  | 69.0      | 101554      | 2084M06900    | 2717CD   |            |         |                    |             |                       |               |                   |
|  |       |                            | 60.0   | 69.5      | 102163      | 2084M06950    | 2736CD   |            |         |                    |             |                       |               |                   |
| 475cc Big Bore Kit Twin Cylinder                     |       | 71.0                       | 475.0  | 71.0      |             | 102086        | 2795CD   | S259       | CW16    | W5294              | B1021       |                       |               |                   |
| JS440  | 76-92 | x                          | 481.0  | 71.5      | 102892      | 102087        | 2815CD   |            |         |                    |             |                       |               |                   |
|  |       |                            | 60.0   | 72.0      | 102893      | 102088        | 2835CD   |            |         |                    |             |                       |               |                   |
|  |       |                            | 496.0  | 72.5      |             | 101350        | 2854CD   |            |         |                    |             |                       |               |                   |
|  |       |                            | 502.0  | 73.0      | 103088      | 101351        | 2874CD   |            |         |                    |             |                       |               |                   |
| 550cc Twin Cylinder                                  |       | 75.0                       | 531.0  | 75.0      | 103539      | 101240        | 104493   | S259       | CW16    | 101868             | B1021       |                       |               |                   |
| 550 SX   | 89-91 | x                          | 537.0  | 75.5      | 103540      | 101241        | 104495   |            |         |                    |             |                       |               |                   |
| JS550  | 82-88 | 60.0                       | 544.0  | 76.0      | 103541      | 101242        | 2992TC   |            |         |                    |             |                       |               |                   |
| * Crankcase machining required for 76.5mm and larger |       |                            | 551.0  | 76.5      | 101970      | 100661        | 3012TC   |            |         |                    |             |                       |               |                   |
|  |       |                            | 559.0  | 77.0      | 101971      | 100662        | 3032TC   |            |         |                    |             |                       |               |                   |
| 550cc Twin Cylinder                                  |       | 75.0                       | 531.0  | 75.0      | 103570      | 101713        | 2953TD   | S259       | CW16    | 100658             | B1021       |                       |               |                   |
| 550 SX   | 92-95 | x                          | 537.0  | 75.5      | 103571      | 101714        | 2973TD   |            |         |                    |             |                       |               |                   |
| * Crankcase machining required for 76.5mm and larger |       |                            | 60.0   | 76.0      | 103572      | 101715        | 2992TD   |            |         |                    |             |                       |               |                   |
|  |       |                            | 551.0  | 76.5      |             | 112277        | 3012TD   |            |         |                    |             |                       |               |                   |
| 650cc Twin Cylinder                                  |       | 76.0                       | 635.0  | 76.0      | 101782      | 102347        | 2992TD   | S513       | CW18    | 100665             | B1022       |                       | 100483        | 100494            |
| 650 SX   | 87-93 | x                          | 643.0  | 76.5      | 101783      | 102348        | 3012TD   |            |         |                    |             |                       |               | LT Only           |
| SC 650   | 91-95 | 70.0                       | 657.0  | 77.0      | 101784      | 102349        | 3032TD   |            |         |                    |             |                       |               | 87-04             |
| TS 650   | 89-96 |                            | 660.0  | 77.5      | 102895      | 103423        | 3051TD   |            |         |                    |             |                       |               | SX                |
| X-2 (650)  | 86-95 |                            | 668.0  | 78.0      | 102896      | 103424        | 3071TD   |            |         |                    |             |                       |               |                   |
| * Crankcase machining required for 77.5mm and larger |       |                            |        |           |             |               |          |            |         |                    |             |                       |               |                   |
| 750cc Twin Cylinder 20mm Pin                         |       | 80.0                       | 743.0  | 80.0      | 102341      | 104059        | 3150KD   | S650       | CW20    | 102510             | B1023       |                       | 100483        |                   |
| 750 SS / SX  | 92-95 | x                          | 752.0  |           | 102342      | 104060        | 3169KD   |            |         | 80-                |             |                       |               |                   |
| 750 ZXi  | 95    | 74.0                       | 760.0  |           | 102343      | 104061        | 3189KD   |            |         | 83mm               |             |                       |               |                   |
| ST 750   | 93-95 |                            | 771.0  |           | 103128      | 103211        | 3207KD   |            |         | 104282             |             |                       |               |                   |
| STS 750  | 95    |                            | 779.0  |           | 103129      | 103212        | 3228KD   |            |         | 85-                |             |                       |               |                   |
| Super Sport Xi 750                                   | 93-95 |                            | 795.0  |           | 103130      | 103213        | 3268KD   |            |         | 85.5mm             |             |                       |               |                   |
| XiR 750  | 94    |                            | 840.0  |           | 101767      | 103214        | 3347KD   |            |         |                    |             |                       |               |                   |
| * Crankcase machining required for 83mm and larger   |       |                            | 850.0  |           | 101768      | 103215        | 3367KD   |            |         |                    |             |                       |               |                   |

- accessories
- towables
- body
- controls
- electrical
- driveline
- engine
- fuel & intake
- chemicals
- tie downs
- tools
- towing & loading

# MARINE

# ENGINE



## PERSONAL WATERCRAFT PISTONS AND GASKET SETS



- accessories
- towables
- body
- controls
- electrical
- driveline
- engine
- fuel & intake
- chemicals
- tie downs
- tools
- towing & loading

| MODEL  | YEARS | STOCK ENGINE BORE X STROKE | DISP.  | BORE SIZE | TOP END KIT | SINGLE PISTON | RING SET | PISTON PIN | CIRCLIP | TOP END GASKET KIT | TOP END BRG | BOTTOM END GASKET KIT | MAIN SEAL KIT | MAIN BEARING / KIT |
|--|-------|----------------------------|--------|-----------|-------------|---------------|----------|------------|---------|--------------------|-------------|-----------------------|---------------|--------------------|
| <b>KAWASAKI - 2 STROKE CONTINUED</b>               |       |                            |        |           |             |               |          |            |         |                    |             |                       |               |                    |
| 750cc Twin Cylinder 22mm Pin                       |       | 80.0                       | 743.0  | 80.0      | 102344      | 104056        |          | S662       | CW22    | 102510             | B1030       |                       | 100483        |                    |
| 750 SS   | 96-97 | x                          | 752.0  | 80.5      | 102345      | 104057        | 3169KD   |            |         | 80-83mm            |             |                       |               |                    |
| 750 STX  | 98    | 74.0                       | 760.0  | 81.0      | 102346      | 104058        | 3189KD   |            |         |                    |             |                       |               |                    |
| 750 ZXi  | 96-97 |                            | 771.0  | 81.5      | 103131      | 103206        | 3207KD   |            |         | 104466             |             |                       |               |                    |
| STS 750  | 96-97 |                            | 779.0  | 82.0      | 103132      | 103207        | 3228KD   |            |         | 84-84.5mm          |             |                       |               |                    |
| Super Sport Xi 750                                 | 96-97 |                            | 795.0  | 83.0      | 102177      | 103208        | 3268KD   |            |         |                    |             |                       |               |                    |
| Xi Sport 750                                       | 98-99 |                            | 820.0  | 84.0      | 102178      | 103209        | 3307KD   |            |         |                    |             |                       |               |                    |
| * Crankcase machining required for 83mm and larger |       |                            | 830.0  | 84.5      | 102179      | 103210        | 3327KD   |            |         |                    |             |                       |               |                    |
| 750cc Twin Cylinder                                |       | 80.0                       | 791.0  | 82.5      |             | 102140        | 104468   | S640       | CW22    | 102510             | B1030       |                       | 100483        |                    |
| 750 SXi  | 95-96 | x                          | 800.0  | 82.96     |             | 102141        | 111880   |            |         | 96-02              |             |                       |               |                    |
| 750 SXi Pro  | 98-02 | 74.0                       |        |           |             |               |          |            |         |                    |             |                       |               |                    |
| 800cc  |       | 82.0                       | 782.0  | 82.0      |             | 102246        | 3228KD   | S662       | CW22    | 100714             | B1030       |                       | 100483        | 100494             |
| 800 SX-R   | 03-11 | x                          | 791.0  | 82.5      |             | 102247        | 3248KD   |            |         | 03-08              |             |                       |               | Left Only          |
|  |       | 74.0                       | 800.0  | 82.96     |             | 102142        | 3268KD   |            |         |                    |             |                       |               |                    |
| 800cc  |       | 82.0                       | 791.0  | 82.5      |             | 102140        | 104468   | S662       | CW22    | 100714             | B1030       |                       | 100483        | 100494             |
| 800 SX-R   | 03-11 | x                          | 800.0  | 82.96     |             | 102141        | 111880   |            |         | 03-08              |             |                       |               | Left Only          |
|  |       | 74.0                       |        |           |             |               |          |            |         |                    |             |                       |               |                    |
| 900cc Triple Cylinder                              |       | 73.0                       | 891.0  | 73.0      | 102274      | 103715        | 2874CD   | S512       | CW20    | 102844             | B1023       |                       |               |                    |
| 900 STS  | 01-02 | x                          | 903.0  | 73.5      | 102275      | 103716        | 2894CD   |            |         |                    |             |                       |               |                    |
| 900 STX  | 97-06 | 71.0                       | 915.0  | 74.0      | 102276      | 103717        | 2913CD   |            |         |                    |             |                       |               |                    |
| 900 ZXi  | 95-97 |                            | 928.0  | 74.5      | 103253      | 101642        |          |            |         |                    |             |                       |               |                    |
| 1100cc Triple Cylinder/ Big Pin                    |       | 80.0                       | 1071.0 | 80.0      | 102249      | 104056        |          | S662       | CW22    | 104179             | B1030       |                       |               |                    |
| 1100 STX   | 97-99 | x                          | 1083.0 | 80.5      | 102250      | 104057        | 3169KD   |            |         | 80-81.5mm          |             |                       |               |                    |
| 1100 ZXi   | 96-03 | 71.0                       | 1097.0 | 81.0      | 102251      | 104058        | 3189KD   |            |         | 104246             |             |                       |               |                    |
| * Crankcase machining required for 83mm and larger |       |                            | 1106.0 | 81.5      | 102397      | 103206        | 3207KD   |            |         | 82-84.5mm          |             |                       |               |                    |
|  |       |                            | 1125.0 | 82.0      | 102459      | 103207        | 3228KD   |            |         |                    |             |                       |               |                    |
|  |       |                            | 1151.0 | 83.0      | 102460      | 103208        | 3268KD   |            |         |                    |             |                       |               |                    |
|  |       |                            | 1179.0 | 84.0      | 102461      | 103209        | 3307KD   |            |         |                    |             |                       |               |                    |
|  |       |                            | 1193.0 | 84.5      |             | 103210        | 3327KD   |            |         |                    |             |                       |               |                    |
| 1200cc Triple Cylinder                             |       | 80.0                       | 1176.0 | 80.0      | 102399      | 104054        | 3150TD   | S598       | CW24    | 104002             | 104740      |                       |               |                    |
| Ultra 150 (1200)                                   | 99-05 | x                          | 1191.0 | 80.5      | 102400      | 104055        | 3169TD   |            |         |                    |             |                       |               |                    |
|  |       | 78.0                       |        |           |             |               |          |            |         |                    |             |                       |               |                    |
| <b>KAWASAKI - 4 STROKE</b>                         |       |                            |        |           |             |               |          |            |         |                    |             |                       |               |                    |
| 1500 Four Cylinder                                 |       | 83.0                       | 1498.0 | 83.0      |             | 111992        | 111577   |            |         | 111697             |             |                       |               |                    |
| Ultra 260 LX                                       | 09-10 | x                          |        |           |             |               |          |            |         |                    |             |                       |               |                    |
| Ultra 260 X  | 09-10 | 69.2                       |        |           |             |               |          |            |         |                    |             |                       |               |                    |
| 1500 Four Cylinder                                 |       | 83.0                       | 1498.0 | 83.0      |             | 111993        | 3268XG   | 104769     | CW21    |                    |             |                       |               |                    |
| Ultra LX   | 07-12 | x                          |        |           |             |               |          |            |         |                    |             |                       |               |                    |
| STX 15-F   | 04-12 | 69.2                       |        |           |             |               |          |            |         |                    |             |                       |               |                    |
| STX  | 09-10 |                            |        |           |             |               |          |            |         |                    |             |                       |               |                    |
| <b>POLARIS - 2 STROKE</b>                          |       |                            |        |           |             |               |          |            |         |                    |             |                       |               |                    |
| 650cc Triple Cylinder                              |       | 65.0                       | 647.0  | 65.0      | 103311      | 103461        | 2559CD   | S280       | CW18    | 102143             | B1014       |                       |               |                    |
| SL 650   | 92-95 | x                          | 665.0  | 66.0      | 103312      | 103462        | 2598CD   |            |         |                    |             |                       |               |                    |
| SL 650 STD   | 95    | 65.0                       |        |           |             |               |          |            |         |                    |             |                       |               |                    |
| 700cc Twin Cylinder                                |       | 81.0                       | 700.0  | 81.0      | 101959      | 103304        | 3189TD   | S512       | CW20    | 104405             | B1039       |                       |               |                    |
| Freedom 700  | 02-04 | x                          | 710.0  | 81.5      | 101960      | 103305        | 3209TD   |            |         | 96-00              |             |                       |               |                    |
| Hurricane 700 / SL 700                             | 96-97 | 68.0                       | 718.0  | 82.0      | 101961      | 103306        | 3228TD   |            |         |                    |             |                       |               |                    |
| SL 700 Deluxe                                      | 97    |                            | 726.0  | 82.5      | 103146      | 100686        | 104337   |            |         |                    |             |                       |               |                    |
| SLH 700  | 98-01 |                            | 734.0  | 83.0      | 103147      | 100687        | 3268TD   |            |         |                    |             |                       |               |                    |
| SLT 700  | 96-97 |                            |        |           |             |               |          |            |         |                    |             |                       |               |                    |
| SLTH 700   | 98-99 |                            |        |           |             |               |          |            |         |                    |             |                       |               |                    |
| Virage 700   | 02-04 |                            |        |           |             |               |          |            |         |                    |             |                       |               |                    |

MARINE



## PERSONAL WATERCRAFT PISTONS AND GASKET SETS



| MODEL   | YEARS | STOCK ENGINE BORE X STROKE | DISP.  | BORE SIZE | TOP END KIT | SINGLE PISTON | RING SET | PISTON PIN | CIRCLIP | TOP END GASKET KIT | TOP END BRG | BOTTOM END GASKET KIT | MAIN SEAL KIT | MAIN BEARING /KIT |
|---|-------|----------------------------|--------|-----------|-------------|---------------|----------|------------|---------|--------------------|-------------|-----------------------|---------------|-------------------|
| <b>POLARIS - 2 STROKE CONTINUED</b>                         |       |                            |        |           |             |               |          |            |         |                    |             |                       |               |                   |
| 750cc Triple Cylinder                                       |       | 69.8                       | 744.0  | 69.8      | 102198      | 102225        | 2746CD   | S343       | CW18    | 102144             | B1014       |                       |               |                   |
| SL 750  | 93-95 | x                          | 755.0  | 70.3      | 102199      | 102226        | 2766CD   |            |         | 69.75-70.75mm      |             |                       |               |                   |
| SLT 750   | 94-95 | 65.0                       | 766.0  | 70.8      | 102200      | 102227        | 2786CD   |            |         | 102145             |             |                       |               |                   |
|   |       |                            | 777.0  | 71.3      | 102040      | 100942        | 2805CD   |            |         | 71.25-72mm         |             |                       |               |                   |
|   |       |                            | 783.0  | 71.5      | 102042      | 100943        | 2815CD   |            |         |                    |             |                       |               |                   |
|   |       |                            | 795.0  | 72.0      | 102041      | 100944        | 2835CD   |            |         |                    |             |                       |               |                   |
| 777cc Twin Cylinder   |       | 84.0                       | 775.8  | 84.0      |             | 101461        | 104470   | S662       | CW22    |                    |             |                       |               |                   |
| Octane 777  | 02-04 | x                          | 785.1  | 84.5      |             | 101462        | 104471   |            |         |                    |             |                       |               |                   |
| Virage i 777  | 02-04 | 70.0                       | 794.4  | 85.0      |             | 101463        | 104472   |            |         |                    |             |                       |               |                   |
|   |       |                            | 799.1  | 85.3      |             | 101735        | 104473   |            |         |                    |             |                       |               |                   |
| 777cc Twin Cylinder   |       | 84.0                       | 794.4  | 85.0      |             | 103797        | 104472   | S662       | CW22    |                    |             |                       |               |                   |
| Octane 777  | 02-04 | x                          |        |           |             |               |          |            |         |                    |             |                       |               |                   |
| * Cylinder head modifications required for low dome profile |       | 70.0                       |        |           |             |               |          |            |         |                    |             |                       |               |                   |
| 780cc Triple Cylinder                                       |       | 71.3                       | 783.0  | 71.5      | 102587      | 100943        | 2815CD   | S343       | CW18    | 104026             | B1014       |                       |               |                   |
| SL 780  | 96-97 | x                          | 794.0  | 72.0      | 102588      | 100944        | 2835CD   |            |         |                    |             |                       |               |                   |
| SLT 780   | 96-97 | 65.0                       |        |           |             |               |          |            |         |                    |             |                       |               |                   |
| SLX 780   | 95-96 |                            |        |           |             |               |          |            |         |                    |             |                       |               |                   |
| 785cc Triple Cylinder                                       |       | 69.7                       | 779.0  | 69.7      | 102109      | 101844        | 2746CD   | S343       | CW18    | 103569             | B1014       |                       |               |                   |
| PRO 785   | 99-00 | x                          |        |           |             |               |          |            |         |                    |             |                       |               |                   |
| SLX PRO 785   | 97-98 | 68.0                       |        |           |             |               |          |            |         |                    |             |                       |               |                   |
| 900cc Triple Cylinder                                       |       | 74.5                       | 889.0  | 74.5      | 102110      | 103301        | 2933TD   | S512       | CW20    | 104187             | B1039       |                       |               |                   |
| SL 900  | 96-97 | x                          | 901.0  | 75.0      | 102111      | 103302        | 2953TD   |            |         |                    |             |                       |               |                   |
|   |       |                            | 68.0   | 913.0     | 102112      | 103303        | 2973TD   |            |         |                    |             |                       |               |                   |
|   |       |                            |        | 76.5      |             | 112278        | 3012TD   |            |         |                    |             |                       |               |                   |
| 1050cc Triple Cylinder                                      |       | 81.0                       | 1051.0 | 81.0      | 103136      | 101344        | 104442   | S512       | CW20    | 104188             | B1039       |                       |               |                   |
| SL 1050   | 97    | x                          | 1064.0 | 81.5      | 103137      | 101345        | 104443   |            |         |                    |             |                       |               |                   |
| SLTX 1050   | 96-99 | 68.0                       | 1077.0 | 82.0      | 103138      | 101346        | 104444   |            |         |                    |             |                       |               |                   |
| SLX 1050  | 99    |                            |        |           |             |               |          |            |         |                    |             |                       |               |                   |
| SLXH 1050   | 98    |                            |        |           |             |               |          |            |         |                    |             |                       |               |                   |
| 1200cc Triple Cylinder                                      |       | 84.0                       | 1163.8 | 84.0      |             | 101461        | 104470   | S539       | CW22    |                    |             |                       |               |                   |
| Genesis 1200  | 99-02 | x                          | 1177.7 | 84.5      |             | 101462        | 104471   |            |         |                    |             |                       |               |                   |
| Genesis FFI 1200  | 99-00 | 70.0                       | 1191.6 | 85.0      |             | 101463        | 104472   |            |         |                    |             |                       |               |                   |
| Genesis Ficht 1200  | 99    |                            | 1198.7 | 85.3      |             | 101735        | 104473   |            |         |                    |             |                       |               |                   |
| Genesis i 1200  | 01-04 |                            |        |           |             |               |          |            |         |                    |             |                       |               |                   |
| PRO 1200  | 00-01 |                            |        |           |             |               |          |            |         |                    |             |                       |               |                   |
| SLTX-B (X-45) 1200  | 99    |                            |        |           |             |               |          |            |         |                    |             |                       |               |                   |
| SLX 1200  | 00-01 |                            |        |           |             |               |          |            |         |                    |             |                       |               |                   |
| Virage TX 1200  | 00-02 |                            |        |           |             |               |          |            |         |                    |             |                       |               |                   |
| Virage TXi 1200   | 01-02 |                            |        |           |             |               |          |            |         |                    |             |                       |               |                   |
| 1200cc Triple Cylinder                                      |       | 84.0                       | 1191.6 | 85.0      |             | 103797        | 104472   | S662       | CW22    |                    |             |                       |               |                   |
| Octane 777  | 02-04 | x                          |        |           |             |               |          |            |         |                    |             |                       |               |                   |
| PRO 1200  | 00-01 | 70.0                       |        |           |             |               |          |            |         |                    |             |                       |               |                   |
| MSX 140 H.O. (1200)   | 03-04 |                            |        |           |             |               |          |            |         |                    |             |                       |               |                   |
| * Cylinder head modifications required for low dome profile |       |                            |        |           |             |               |          |            |         |                    |             |                       |               |                   |
| <b>SEA DOO - 2 STROKE</b>                                   |       |                            |        |           |             |               |          |            |         |                    |             |                       |               |                   |
| 580cc Twin Cylinder   |       | 76.0                       | 580.0  | 76.0      | 103133      | 102260        | 2992TD   | S477       | CW18    | 104221             | B1003       |                       |               |                   |
| Explorer 580 / SPX 580                                      | 93    | x                          | 588.0  | 76.5      | 103134      | 102261        | 3012TD   |            |         |                    |             |                       |               |                   |
| GT 580  | 90-91 | 64.0                       | 595.0  | 77.0      | 103135      | 102262        | 3032TD   |            |         |                    |             |                       |               |                   |
| GTS 580   | 92-96 |                            | 602.0  | 77.5      | 103012      | 103889        | 3051TD   |            |         |                    |             |                       |               |                   |
| GTX 580   | 92-93 |                            |        |           |             |               |          |            |         |                    |             |                       |               |                   |
| Sea-Doo 580   | 88-89 |                            |        |           |             |               |          |            |         |                    |             |                       |               |                   |
| SI 580 / ST 580   | 90    |                            |        |           |             |               |          |            |         |                    |             |                       |               |                   |
| SP 580 / SPI 580  | 91-96 |                            |        |           |             |               |          |            |         |                    |             |                       |               |                   |
| XP 580  | 91-92 |                            |        |           |             |               |          |            |         |                    |             |                       |               |                   |

- accessories
- towables
- body
- controls
- electrical
- driveline
- engine
- fuel & intake
- chemicals
- tie downs
- tools
- towing & loading

# MARINE

# ENGINE



## PERSONAL WATERCRAFT PISTONS AND GASKET SETS



- accessories
- towables
- body
- controls
- electrical
- driveline
- engine**
- fuel & intake
- chemicals
- tie downs
- tools
- towing & loading

| MODEL                               | YEARS | STOCK ENGINE BORE X STROKE | DISP. | BORE SIZE | TOP END KIT      | SINGLE PISTON | RING SET      | PISTON PIN  | CIRCLIP     | TOP END GASKET KIT | TOP END BRG   | BOTTOM END GASKET KIT | MAIN SEAL KIT | MAIN BEARING / KIT |
|-------------------------------------|-------|----------------------------|-------|-----------|------------------|---------------|---------------|-------------|-------------|--------------------|---------------|-----------------------|---------------|--------------------|
| <b>SEA DOO - 2 STROKE CONTINUED</b> |       |                            |       |           |                  |               |               |             |             |                    |               |                       |               |                    |
| 650cc Twin Cylinder                 |       | 78.0                       | 650.0 | 78.0      | <b>101846</b>    | <b>104014</b> | <b>3071LK</b> | <b>S512</b> | <b>CW20</b> | <b>100891</b>      | <b>B1039</b>  |                       | <b>100278</b> |                    |
| Explorer 650                        | 94-96 | x                          | 658.0 | 78.5      | <b>101847</b>    | <b>104015</b> | <b>3091LK</b> |             |             |                    | 95-96         |                       |               |                    |
| GTX 650                             | 94-95 | 68.0                       | 666.0 | 79.0      | <b>101848</b>    | <b>104016</b> | <b>3110LK</b> |             |             |                    |               |                       |               |                    |
| Speedster 650                       | 94-95 |                            | 674.0 | 80.0      | <b>103121</b>    | <b>103557</b> | <b>3150LK</b> |             |             |                    |               |                       |               |                    |
| Sportster 650                       | 95    |                            |       |           |                  |               |               |             |             |                    |               |                       |               |                    |
| SPX 650                             | 94-95 |                            |       |           |                  |               |               |             |             |                    |               |                       |               |                    |
| XP 650                              | 93-94 |                            |       |           |                  |               |               |             |             |                    |               |                       |               |                    |
| 718cc Twin Cylinder                 |       | 82.0                       | 718.0 | 82.0      | <b>101849</b>    | <b>104017</b> | <b>104444</b> | <b>S461</b> | <b>CW20</b> | <b>100892</b>      | <b>104737</b> |                       | <b>100278</b> |                    |
| Challenger 718                      | 98    | x                          | 726.0 | 82.5      | <b>101850</b>    | <b>104018</b> | <b>104446</b> |             |             |                    |               |                       |               |                    |
| Challenger 718                      | 00-01 | 68.0                       | 735.0 | 83.0      | <b>101851</b>    | <b>104019</b> | <b>104447</b> |             |             |                    |               |                       |               |                    |
| Explorer 718                        | 97    |                            | 744.0 | 83.5      | <b>103122</b>    | <b>103558</b> | <b>104448</b> |             |             |                    |               |                       |               |                    |
| Explorer 718                        | 02    |                            | 754.0 | 84.0      | <b>103123</b>    | <b>103559</b> | <b>104449</b> |             |             |                    |               |                       |               |                    |
| GS 718                              | 97-01 |                            |       |           |                  |               |               |             |             |                    |               |                       |               |                    |
| GSI 718                             | 97    |                            |       |           |                  |               |               |             |             |                    |               |                       |               |                    |
| GTI 718                             | 96-05 |                            |       |           |                  |               |               |             |             |                    |               |                       |               |                    |
| GTI 718 LE                          | 02-04 |                            |       |           |                  |               |               |             |             |                    |               |                       |               |                    |
| GTS 718                             | 97-01 |                            |       |           |                  |               |               |             |             |                    |               |                       |               |                    |
| HX 718 / XP 718                     | 95-97 |                            |       |           |                  |               |               |             |             |                    |               |                       |               |                    |
| SP 718                              | 97    |                            |       |           |                  |               |               |             |             |                    |               |                       |               |                    |
| Speedster 718                       | 96-97 |                            |       |           |                  |               |               |             |             |                    |               |                       |               |                    |
| Speedster 718 SK                    | 99    |                            |       |           |                  |               |               |             |             |                    |               |                       |               |                    |
| Sportster 1800 (718)                | 98-99 |                            |       |           |                  |               |               |             |             |                    |               |                       |               |                    |
| Sportster 718                       | 96-98 |                            |       |           |                  |               |               |             |             |                    |               |                       |               |                    |
| Sportster 718 LT                    | 02    |                            |       |           |                  |               |               |             |             |                    |               |                       |               |                    |
| SPX 718                             | 96    |                            |       |           |                  |               |               |             |             |                    |               |                       |               |                    |
| 780cc Twin Cylinder                 |       | 82.0                       | 780.0 | 82.0      | <b>103176</b>    | <b>104020</b> | <b>104444</b> | <b>S461</b> | <b>CW20</b> | <b>100474</b>      | <b>104738</b> |                       |               |                    |
| 3D Base 782                         | 05    | x                          | 785.0 | 82.1      | <b>103177</b>    | <b>104021</b> | <b>104445</b> |             |             | 95-02              |               |                       |               |                    |
| 3D Premium 782                      | 05    | 74.0                       | 791.0 | 82.5      | <b>103178</b>    | <b>104022</b> | <b>104446</b> |             |             |                    |               |                       |               |                    |
| Challenger 1800 (782)               | 97-99 |                            | 800.0 | 83.0      |                  | <b>112279</b> | <b>104447</b> |             |             |                    |               |                       |               |                    |
| Challenger 782                      | 96-97 |                            | 801.0 | 83.0      | <b>103179</b>    | <b>104023</b> | <b>104447</b> |             |             |                    |               |                       |               |                    |
| GSX 782                             | 96-97 |                            | 810.0 | 83.5      | <b>102425</b>    | <b>103560</b> | <b>104448</b> |             |             |                    |               |                       |               |                    |
| GSX 782 RFI                         | 99-00 |                            | 820.0 | 84.0      | <b>102426</b>    | <b>103561</b> | <b>104449</b> |             |             |                    |               |                       |               |                    |
| GTI 782 LE                          | 05    |                            |       |           |                  |               |               |             |             |                    |               |                       |               |                    |
| GTI 782 LE RFI                      | 03-05 |                            |       |           |                  |               |               |             |             |                    |               |                       |               |                    |
| GTI 782 RFI                         | 04-05 |                            |       |           |                  |               |               |             |             |                    |               |                       |               |                    |
| GTX 782                             | 96-99 |                            |       |           |                  |               |               |             |             |                    |               |                       |               |                    |
| GTX 782 RFI                         | 98-02 |                            |       |           |                  |               |               |             |             |                    |               |                       |               |                    |
| Speedster 782                       | 98-99 |                            |       |           |                  |               |               |             |             |                    |               |                       |               |                    |
| SPX 782                             | 97-99 |                            |       |           |                  |               |               |             |             |                    |               |                       |               |                    |
| XP 782                              | 96-97 |                            |       |           |                  |               |               |             |             |                    |               |                       |               |                    |
| XP-800 LTD (782)                    | 95    |                            |       |           |                  |               |               |             |             |                    |               |                       |               |                    |
| XP-800 LTD (782)                    | 97    |                            |       |           |                  |               |               |             |             |                    |               |                       |               |                    |
| 785cc Twin Cylinder                 |       | 82.0                       | 780.0 | 82.0      | <b>101174</b>    |               | <b>104467</b> | <b>S461</b> | <b>CW20</b> | <b>100474</b>      | <b>104738</b> |                       | <b>104172</b> |                    |
| 3D Base 782                         | 05    | x                          | 785.0 | 82.1      | <b>778M08210</b> |               | <b>104467</b> |             |             |                    |               |                       |               |                    |
| 3D Premium 782                      | 05    | 74.0                       | 791.0 | 82.5      | <b>101175</b>    |               | <b>104468</b> |             |             |                    |               |                       |               |                    |
| Challenger 1800 (782)               | 97-99 |                            | 800.0 | 83.0      | <b>101176</b>    |               | <b>111880</b> |             |             |                    |               |                       |               |                    |
| Challenger 782                      | 96-97 |                            |       |           |                  |               |               |             |             |                    |               |                       |               |                    |
| GSX 782                             | 96-97 |                            |       |           |                  |               |               |             |             |                    |               |                       |               |                    |
| GSX 782 RFI                         | 99-00 |                            |       |           |                  |               |               |             |             |                    |               |                       |               |                    |
| GTI 782 LE                          | 05    |                            |       |           |                  |               |               |             |             |                    |               |                       |               |                    |
| GTI 782 LE RFI                      | 03-05 |                            |       |           |                  |               |               |             |             |                    |               |                       |               |                    |
| GTI 782 RFI                         | 04-05 |                            |       |           |                  |               |               |             |             |                    |               |                       |               |                    |
| GTX 782                             | 96-99 |                            |       |           |                  |               |               |             |             |                    |               |                       |               |                    |
| GTX 782 RFI                         | 98-02 |                            |       |           |                  |               |               |             |             |                    |               |                       |               |                    |
| Speedster 782                       | 98-99 |                            |       |           |                  |               |               |             |             |                    |               |                       |               |                    |
| SPX 782                             | 97-99 |                            |       |           |                  |               |               |             |             |                    |               |                       |               |                    |
| XP 782                              | 96-97 |                            |       |           |                  |               |               |             |             |                    |               |                       |               |                    |
| XP-800 LTD (782)                    | 95    |                            |       |           |                  |               |               |             |             |                    |               |                       |               |                    |
| XP-800 LTD (782)                    | 97    |                            |       |           |                  |               |               |             |             |                    |               |                       |               |                    |

MARINE



## PERSONAL WATERCRAFT PISTONS AND GASKET SETS



| MODEL  | YEARS | STOCK ENGINE BORE X STROKE | DISP.  | BORE SIZE | TOP END KIT | SINGLE PISTON | RING SET | PISTON PIN | CIRCLIP | TOP END GASKET KIT | TOP END BRG | BOTTOM END GASKET KIT | MAIN SEAL KIT | MAIN BEARING / KIT |
|--|-------|----------------------------|--------|-----------|-------------|---------------|----------|------------|---------|--------------------|-------------|-----------------------|---------------|--------------------|
| <b>SEA DOO - 2 STROKE CONTINUED</b>                |       |                            |        |           |             |               |          |            |         |                    |             |                       |               |                    |
| 950cc Twin Cylinder                                |       | 88.0                       | 951.0  | 88.0      | 101841      | 104096        | 3464KD   | 104570     | CW21    | 104192             |             |                       | 104173        | 104154             |
| 3D 950 DI  | 06-07 | x                          | 960.0  | 88.5      | 101842      | 104097        |          |            |         | Carb Models        |             |                       |               | Left Only          |
| GSX 950 LTD  | 97-99 | 78.2                       | 971.0  | 89.0      | 101843      | 104098        | 111618   |            |         | 88-90mm            |             |                       |               |                    |
| GTX 950  | 00-02 |                            | 982.0  | 89.4      | 101830      | 102762        | 111619   |            |         |                    |             |                       |               |                    |
| GTX 950 DI   | 00-03 |                            | 993.0  | 90.0      | 101831      | 102763        | 111620   |            |         | 101706             |             |                       |               |                    |
| GTX 950 LTD  | 98-02 |                            | 1017.0 | 91.0      | 102470      | 102764        | 111622   |            |         | Carb Models        |             |                       |               |                    |
| LRV 950  | 00-03 |                            |        |           |             |               |          |            |         | 91mm               |             |                       |               |                    |
| LVR 950 DI   | 00-03 |                            |        |           |             |               |          |            |         |                    |             |                       |               |                    |
| RX 950   | 00-02 |                            |        |           |             |               |          |            |         |                    |             |                       |               |                    |
| RX 950 DI  | 00-03 |                            |        |           |             |               |          |            |         |                    |             |                       |               |                    |
| RXX 950  | 01-02 |                            |        |           |             |               |          |            |         | 103635             |             |                       |               |                    |
| Sportster 950 LE                                   | 00-03 |                            |        |           |             |               |          |            |         | DI Models          |             |                       |               |                    |
| Sportster 950 LE DI                                | 04-05 |                            |        |           |             |               |          |            |         |                    |             |                       |               |                    |
| VSP 950 LTD  | 99-03 |                            |        |           |             |               |          |            |         |                    |             |                       |               |                    |
| XP 950   | 00-02 |                            |        |           |             |               |          |            |         |                    |             |                       |               |                    |
| XP 950 DI  | 03-04 |                            |        |           |             |               |          |            |         |                    |             |                       |               |                    |
| XP 950 LTD   | 98-03 |                            |        |           |             |               |          |            |         |                    |             |                       |               |                    |
| * Crankcase machining required for 91mm and larger |       |                            |        |           |             |               |          |            |         |                    |             |                       |               |                    |
| <b>SEA DOO - 4 STROKE</b>                          |       |                            |        |           |             |               |          |            |         |                    |             |                       |               |                    |
| RXP/RXP-X/RXT/RXT-X all                            | 04-14 | 100.0                      | 1500.0 | 100.0     |             | 112280        | 3937XS   | S626       |         |                    |             |                       |               |                    |
| RXP 215  |       | x                          |        | 100.5     |             | 112281        | 10050XS  |            |         |                    |             |                       |               |                    |
| RXP-X 255  |       | 63.4                       |        | 101.0     |             | 112282        | 10100XS  |            |         |                    |             |                       |               |                    |
| RXT 255/260  |       |                            |        |           |             |               |          |            |         |                    |             |                       |               |                    |
| RXT-X 255/260                                      |       |                            |        |           |             |               |          |            |         |                    |             |                       |               |                    |
| <b>WET JET - 2 STROKE</b>                          |       |                            |        |           |             |               |          |            |         |                    |             |                       |               |                    |
| 700cc Twin Cylinder                                |       | 81.0                       | 701.0  | 81.0      | 101654      | 103663        | 3189KD   | S631       | CW20    | 102978             | B1031       |                       |               |                    |
| Duo 700  | 95-96 | x                          | 710.0  | 81.5      |             | 103664        | 3207KD   |            |         |                    |             |                       |               |                    |
| Kraze 700  | 96-97 | 68.0                       | 718.0  | 82.0      | 101656      | 103665        | 3228KD   |            |         |                    |             |                       |               |                    |
| ZX 700   | 96-97 |                            | 726.0  | 82.5      |             | 101779        | 3248KD   |            |         |                    |             |                       |               |                    |
|  |       |                            | 735.0  | 83.0      | 101945      | 101780        | 3268KD   |            |         |                    |             |                       |               |                    |
|  |       |                            | 753.0  | 84.0      | 101946      | 101781        | 3307KD   |            |         |                    |             |                       |               |                    |
| <b>YAMAHA - 2 STROKE</b>                           |       |                            |        |           |             |               |          |            |         |                    |             |                       |               |                    |
| 500cc Twin Cylinder                                |       | 72.0                       | 496.0  | 72.0      |             | 112275        | 2835CD   | 104553     | CW20    | 100865             |             |                       |               |                    |
| Wave Jammer 500                                    | 87-90 | x                          | 504.0  | 72.5      |             | 112276        | 2854CD   |            |         |                    |             |                       |               |                    |
| Wave Runner 500                                    | 87-92 | 61.0                       |        |           |             |               |          |            |         |                    |             |                       |               |                    |
| 650cc Twin Cylinder                                |       | 77.0                       | 633.0  | 77.0      | 102939      | 103956        | 3032TD   | S423       | CW20    | 104413             | B1023       | 103652                | 100277        | 102858             |
| Super Jet 650                                      | 90-93 | x                          | 641.0  | 77.5      | 102940      | 103957        | 3051TD   |            |         |                    |             |                       |               |                    |
| Wave Runner III 650                                | 90-96 | 68.0                       | 649.0  | 78.0      | 102941      | 103958        | 3071TD   |            |         |                    |             |                       |               |                    |
| Wave Runner LX 650                                 | 90-92 |                            | 658.0  | 78.5      | 102907      | 103928        | 3091TD   |            |         |                    |             |                       |               |                    |
| Wave Runner VXR 650                                | 91-95 |                            | 667.0  | 79.0      |             |               | 3110TD   |            |         |                    |             |                       |               |                    |
| 701cc Twin Cylinder                                |       | 81.0                       | 701.0  | 81.0      | 103458      | 103663        | 3189KD   | S631       | CW20    | 101557             | B1031       | 100897                | 100277        | 104183             |
| FX-1 700   | 94-95 | x                          | 710.0  | 81.5      | 103459      | 103664        | 3207KD   |            |         | 81-83mm            |             |                       |               |                    |
| Super Jet 700                                      | 94-10 | 68.0                       | 718.0  | 82.0      | 103460      | 103665        | 3228KD   |            |         |                    |             |                       |               |                    |
| Wave Blaster 700                                   | 93-96 |                            | 726.0  | 82.5      | 101753      | 101779        | 3248KD   |            |         | 100268             |             |                       |               |                    |
| Wave Raider 700                                    | 94-98 |                            | 735.0  | 83.0      | 101754      | 101780        | 3268KD   |            |         | 84mm               |             |                       |               |                    |
| Wave Raider 700 Deluxe                             | 95-96 |                            | 753.0  | 84.0      | 102479      | 101781        | 3307KD   |            |         |                    |             |                       |               |                    |
| Wave Runner III GP 700                             | 94-97 |                            |        |           |             |               |          |            |         |                    |             |                       |               |                    |
| Wave Runner PRO VXR 700                            | 93-94 |                            |        |           |             |               |          |            |         |                    |             |                       |               |                    |
| Wave Runner XL 700                                 | 99-04 |                            |        |           |             |               |          |            |         |                    |             |                       |               |                    |
| Wave Venture 700                                   | 95-98 |                            |        |           |             |               |          |            |         |                    |             |                       |               |                    |
| Wave Venture XL 700                                | 02    |                            |        |           |             |               |          |            |         |                    |             |                       |               |                    |

- accessories
- towables
- body
- controls
- electrical
- driveline
- engine**
- fuel & intake
- chemicals
- tie downs
- tools
- towing & loading

# MARINE

# ENGINE



## PERSONAL WATERCRAFT PISTONS AND GASKET SETS



- accessories
- towables
- body
- controls
- electrical
- driveline
- engine
- fuel & intake
- chemicals
- tie downs
- tools
- towing & loading

| MODEL                              | YEARS | STOCK ENGINE BORE X STROKE | DISP.  | BORE SIZE | TOP END KIT | SINGLE PISTON | RING SET | PISTON PIN | CIRCLIP | TOP END GASKET KIT | TOP END BRG | BOTTOM END GASKET KIT | MAIN SEAL KIT | MAIN BEARING / KIT |
|------------------------------------|-------|----------------------------|--------|-----------|-------------|---------------|----------|------------|---------|--------------------|-------------|-----------------------|---------------|--------------------|
| <b>YAMAHA - 2 STROKE CONTINUED</b> |       |                            |        |           |             |               |          |            |         |                    |             |                       |               |                    |
| 760cc Twin Cylinder                |       | 84.0                       | 754.0  | 84.0      | 102497      | 102799        | 3307KD   | S631       | CW20    | 101596             | B1031       | 103652                | 100277        | 102858             |
| Wave Blaster 760                   | 96-97 | x                          | 763.0  | 84.5      | 102498      | 102800        | 3327KD   |            |         |                    |             |                       |               |                    |
| Wave Raider 760                    | 96-97 | 68.0                       | 771.0  | 85.0      | 102499      | 102801        | 3347KD   |            |         | 84-85mm            |             |                       |               |                    |
| Wave Runner II 760                 | 96-97 |                            | 780.0  | 85.5      | 101962      | 103351        | 3367KD   |            |         | 100269             |             |                       |               |                    |
| Wave Venture 760                   | 97    |                            | 789.0  | 86.0      | 101963      | 103352        |          |            |         | 86mm               |             |                       |               |                    |
| 784cc Twin Cylinder                |       | 80.0                       | 784.0  | 80.0      | 102115      | 102711        |          | S640       | CW22    | 101118             | 104739      |                       |               |                    |
| Wave Runner GP 800                 | 98-05 | x                          | 794.0  | 81.0      | 102116      | 102712        | 3189KD   |            |         |                    |             |                       |               |                    |
| Wave Runner XL 800                 | 00-01 | 78.0                       | 804.0  |           |             |               |          |            |         |                    |             |                       |               |                    |
| Wave Runner XLT 800                | 02-04 |                            |        |           |             |               |          |            |         |                    |             |                       |               |                    |
| 1100cc Triple Cylinder             |       | 81.0                       | 1051.0 | 81.0      | 103085      | 102713        | 3189KD   | S631       | CW20    | 104025             | B1031       |                       | 100277        | 102858             |
| Wave Raider 1100                   | 95-96 | x                          | 1064.0 | 81.5      | 103086      | 102714        | 3207KD   |            |         |                    |             |                       |               |                    |
| Wave Venture 1100                  | 96-97 | 68.0                       | 1077.0 | 82.0      | 103087      | 102715        | 3228KD   |            |         |                    |             |                       |               |                    |
|                                    |       |                            | 1090.0 | 82.5      | 102682      | 102181        | 3248KD   |            |         |                    |             |                       |               |                    |
| 1200cc Triple Cylinder             |       | 84.0                       | 1131.0 | 84.0      | 102408      | 102799        | 3307KD   | S631       | CW20    | 101257             | B1031       |                       | 104171        | 104183             |
| Wave Runner GP 1200                | 97-99 | x                          | 1142.0 | 84.5      | 102409      | 102800        | 3327KD   |            |         |                    |             |                       | GP / XL Model | SUV Model          |
| Wave Runner SUV 1200               | 99-04 | 68.0                       | 1156.0 | 85.0      | 102410      | 102801        | 3347KD   |            |         |                    |             |                       | 100277        | SUV Model          |
| Wave Runner XL 1200                | 98    |                            | 1169.0 | 85.5      | 103070      | 103351        | 3367KD   |            |         |                    |             |                       |               |                    |
|                                    |       |                            | 1184.0 | 86.0      | 103071      | 103352        |          |            |         |                    |             |                       |               |                    |
| 1200cc Triple Cylinder             |       | 80.0                       | 1176.0 | 80.0      | 102711      | 102711        |          | S640       | CW22    | 102107             | 104739      |                       | 104171        |                    |
| Wave Runner GP 1200                | 00-02 | x                          | 1191.0 | 81.0      | 102712      | 102712        | 3189KD   |            |         |                    |             |                       |               |                    |
| Wave Runner XL 1200 LTD            | 99-00 | 78.0                       | 1206.0 |           |             |               |          |            |         |                    |             |                       |               |                    |
| 1300cc Triple Cylinder             | 03-07 | 84.0                       | 1176.0 | 84.0      |             | 101247        | 3307KD   | S539       | CW22    |                    | 104739      |                       |               |                    |
|                                    |       | x                          | 1191.0 |           |             |               |          |            |         |                    |             |                       |               |                    |
|                                    |       | 78.0                       | 1206.0 |           |             |               |          |            |         |                    |             |                       |               |                    |
| <b>YAMAHA - 4 STROKE</b>           |       |                            |        |           |             |               |          |            |         |                    |             |                       |               |                    |
| 998cc Four Cylinder                | 02-06 | 74.0                       |        | 74.0      | 4707M07400  |               |          | 2913XA     | S532    |                    |             |                       |               |                    |
| FX140 / FX140 Cruiser              |       | x                          |        |           |             |               |          |            |         |                    |             |                       |               |                    |
|                                    |       | 58.0                       |        |           |             |               |          |            |         |                    |             |                       |               |                    |
| 1050cc Four Cylinder               | 05-12 | 76.0                       | 1052.6 | 76.0      | 112284      |               |          | 2992XG     | S532    | CW17               |             |                       |               |                    |
| VX1050 Cruiser                     |       | x                          |        |           |             |               |          |            |         |                    |             |                       |               |                    |
| VX1050 Sport                       |       | 58.0                       |        |           |             |               |          |            |         |                    |             |                       |               |                    |
| VX1050 Deluxe                      |       |                            |        |           |             |               |          |            |         |                    |             |                       |               |                    |
| 1800cc Four Cylinder               | 08-12 | 86.0                       | 1812.7 | 86.0      | 112283      |               |          |            |         | 111695             |             |                       |               |                    |
| FX Cruiser SHO                     | 08-11 | x                          |        |           |             |               |          |            |         |                    |             |                       |               |                    |
| FX SHO                             | 08-11 | 78.0                       |        |           |             |               |          |            |         |                    |             |                       |               |                    |
| FZR                                | 09-12 |                            |        |           |             |               |          |            |         |                    |             |                       |               |                    |
| FZS                                | 09-12 |                            |        |           |             |               |          |            |         |                    |             |                       |               |                    |



## PERSONAL WATERCRAFT PRICING



|        |        |   |        |        |   |        |        |   |        |        |   |
|--------|--------|---|--------|--------|---|--------|--------|---|--------|--------|---|
| 100268 | 55.56  | G | 101780 | 138.00 | G | 102225 | 128.00 | G | 102799 | 128.00 | G |
| 100269 | 55.56  | G | 101781 | 138.00 | G | 102226 | 128.00 | G | 102800 | 128.00 | G |
| 100277 | 49.95  | G | 101782 | 283.31 | G | 102227 | 128.00 | G | 102801 | 128.00 | G |
| 100278 | 49.95  | G | 101783 | 283.31 | G | 102246 | 138.00 | G | 102844 | 108.08 | G |
| 100474 | 75.09  | G | 101784 | 283.31 | G | 102247 | 138.00 | G | 102858 | 59.95  | G |
| 100483 | 32.95  | G | 101830 | 411.38 | G | 102249 | 470.17 | G | 102892 | 323.29 | G |
| 100494 | 18.26  | G | 101831 | 411.38 | G | 102250 | 470.17 | G | 102893 | 323.29 | G |
| 100658 | 50.02  | G | 101841 | 383.38 | G | 102251 | 470.17 | G | 102895 | 303.31 | G |
| 100661 | 128.00 | G | 101842 | 383.38 | G | 102260 | 142.00 | G | 102896 | 303.31 | G |
| 100662 | 128.00 | G | 101843 | 383.38 | G | 102261 | 142.00 | G | 102907 | 327.67 | G |
| 100665 | 47.31  | G | 101844 | 138.00 | G | 102262 | 142.00 | G | 102939 | 307.67 | G |
| 100686 | 138.00 | G | 101846 | 327.02 | G | 102274 | 522.08 | G | 102940 | 307.67 | G |
| 100687 | 138.00 | G | 101847 | 327.02 | G | 102275 | 522.08 | G | 102941 | 307.67 | G |
| 100714 | 62.73  | G | 101848 | 327.02 | G | 102276 | 522.08 | G | 102947 | 156.55 | G |
| 100865 | 68.52  | G | 101849 | 375.02 | G | 102280 | 307.84 | G | 102948 | 156.55 | G |
| 100866 | 28.55  | G | 101850 | 375.02 | G | 102281 | 307.84 | G | 102951 | 446.24 | G |
| 100891 | 71.02  | G | 101851 | 375.02 | G | 102282 | 307.84 | G | 102976 | 39.29  | G |
| 100892 | 71.02  | G | 101868 | 41.92  | G | 102341 | 321.00 | G | 102978 | 39.29  | G |
| 100897 | 84.44  | G | 101898 | 146.55 | G | 102342 | 321.00 | G | 103012 | 389.30 | G |
| 100942 | 138.00 | G | 101899 | 146.55 | G | 102343 | 321.00 | G | 103070 | 514.31 | G |
| 100943 | 138.00 | G | 101900 | 146.55 | G | 102344 | 321.00 | G | 103071 | 514.31 | G |
| 100944 | 138.00 | G | 101945 | 315.29 | G | 102345 | 321.00 | G | 103081 | 548.24 | G |
| 101118 | 102.94 | G | 101946 | 315.29 | G | 102346 | 321.00 | G | 103083 | 476.24 | G |
| 101174 | 138.00 | G | 101959 | 310.17 | G | 102347 | 118.00 | G | 103085 | 510.85 | G |
| 101175 | 138.00 | G | 101960 | 310.17 | G | 102348 | 118.00 | G | 103086 | 510.85 | G |
| 101176 | 138.00 | G | 101961 | 310.17 | G | 102349 | 118.00 | G | 103087 | 510.85 | G |
| 101240 | 118.00 | G | 101962 | 331.56 | G | 102397 | 500.17 | G | 103088 | 343.29 | G |
| 101241 | 118.00 | G | 101963 | 331.56 | G | 102399 | 570.12 | G | 103121 | 347.02 | G |
| 101242 | 118.00 | G | 101970 | 297.92 | G | 102400 | 570.12 | G | 103122 | 435.02 | G |
| 101247 | 182.00 | G | 101971 | 297.92 | G | 102408 | 484.31 | G | 103123 | 435.02 | G |
| 101257 | 100.31 | G | 102040 | 484.42 | G | 102409 | 484.31 | G | 103128 | 341.00 | G |
| 101344 | 182.00 | G | 102041 | 484.42 | G | 102410 | 484.31 | G | 103129 | 341.00 | G |
| 101345 | 182.00 | G | 102042 | 484.42 | G | 102425 | 439.09 | G | 103130 | 341.00 | G |
| 101346 | 182.00 | G | 102086 | 142.00 | G | 102426 | 439.09 | G | 103131 | 341.00 | G |
| 101350 | 152.00 | G | 102087 | 142.00 | G | 102449 | 128.00 | G | 103132 | 341.00 | G |
| 101351 | 152.00 | G | 102088 | 142.00 | G | 102450 | 128.00 | G | 103133 | 369.30 | G |
| 101461 | 152.00 | G | 102107 | 193.76 | G | 102451 | 128.00 | G | 103134 | 369.30 | G |
| 101462 | 152.00 | G | 102109 | 485.24 | G | 102459 | 483.75 | G | 103135 | 369.30 | G |
| 101463 | 152.00 | G | 102110 | 488.35 | G | 102460 | 483.75 | G | 103136 | 620.35 | G |
| 101553 | 283.29 | G | 102111 | 488.35 | G | 102461 | 483.75 | G | 103137 | 620.35 | G |
| 101554 | 283.29 | G | 102112 | 488.35 | G | 102470 | 417.97 | G | 103138 | 620.35 | G |
| 101556 | 51.84  | G | 102115 | 378.94 | G | 102479 | 331.56 | G | 103146 | 330.17 | G |
| 101557 | 51.84  | G | 102116 | 378.94 | G | 102497 | 324.05 | G | 103147 | 330.17 | G |
| 101596 | 68.05  | G | 102140 | 182.00 | G | 102498 | 324.05 | G | 103176 | 379.09 | G |
| 101642 | 158.00 | G | 102141 | 182.00 | G | 102499 | 324.05 | G | 103177 | 379.09 | G |
| 101654 | 295.29 | G | 102142 | 158.00 | G | 102510 | 85.00  | G | 103178 | 379.09 | G |
| 101656 | 295.29 | G | 102143 | 70.42  | G | 102587 | 516.64 | G | 103179 | 379.09 | G |
| 101706 | 113.97 | G | 102144 | 70.42  | G | 102588 | 516.64 | G | 103206 | 128.00 | G |
| 101713 | 118.00 | G | 102145 | 70.42  | G | 102682 | 570.85 | G | 103207 | 128.00 | G |
| 101714 | 118.00 | G | 102163 | 303.29 | G | 102711 | 138.00 | G | 103208 | 128.00 | G |
| 101715 | 118.00 | G | 102177 | 305.83 | G | 102712 | 138.00 | G | 103209 | 128.00 | G |
| 101735 | 182.00 | G | 102178 | 305.83 | G | 102713 | 138.00 | G | 103210 | 128.00 | G |
| 101753 | 327.84 | G | 102179 | 305.83 | G | 102714 | 138.00 | G | 103211 | 128.00 | G |
| 101754 | 327.84 | G | 102181 | 158.00 | G | 102715 | 138.00 | G | 103212 | 128.00 | G |
| 101767 | 312.93 | G | 102198 | 454.42 | G | 102762 | 152.00 | G | 103213 | 128.00 | G |
| 101768 | 312.93 | G | 102199 | 454.42 | G | 102763 | 152.00 | G | 103214 | 128.00 | G |
| 101779 | 138.00 | G | 102200 | 454.42 | G | 102764 | 152.00 | G | 103215 | 128.00 | G |

- accessories
- towables
- body
- controls
- electrical
- driveline
- engine**
- fuel & intake
- chemicals
- tie downs
- tools
- towing & loading

# MARINE



## PERSONAL WATERCRAFT PRICING



- accessories
- towables
- body
- controls
- electrical
- driveline
- engine**
- fuel & intake
- chemicals
- tie downs
- tools
- towing & loading

MARINE

|        |        |   |        |        |    |            |        |   |            |        |   |
|--------|--------|---|--------|--------|----|------------|--------|---|------------|--------|---|
| 103253 | 582.08 | G | 104026 | 102.64 | G  | 111697     | 2.00   | G | 3150LK     | 45.67  | G |
| 103301 | 138.00 | G | 104054 | 128.00 | G  | 111880     | 39.88  | G | 3150TD     | 35.77  | G |
| 103302 | 138.00 | G | 104055 | 128.00 | G  | 111992     | 159.00 | G | 3169KD     | 30.85  | G |
| 103303 | 138.00 | G | 104056 | 118.00 | G  | 111993     | 159.00 | G | 3169TD     | 35.77  | G |
| 103304 | 128.00 | G | 104057 | 118.00 | G  | 112275     | 118.00 | G | 3189KD     | 30.85  | G |
| 103305 | 128.00 | G | 104058 | 118.00 | G  | 112276     | 118.00 | G | 3189TD     | 35.77  | G |
| 103306 | 128.00 | G | 104059 | 118.00 | G  | 112277     | 128.00 | G | 3207KD     | 30.85  | G |
| 103311 | 454.42 | G | 104060 | 118.00 | G  | 112278     | 158.00 | G | 3209TD     | 35.77  | G |
| 103312 | 454.42 | G | 104061 | 118.00 | G  | 112279     | 138.00 | G | 3228KD     | 30.85  | G |
| 103351 | 138.00 | G | 104096 | 138.00 | G  | 112280     | 189.00 | G | 3228TD     | 35.77  | G |
| 103352 | 138.00 | G | 104097 | 138.00 | G  | 112281     | 189.00 | G | 3248KD     | 30.85  | G |
| 103411 | 92.24  | G | 104098 | 138.00 | G  | 112282     | 189.00 | G | 3268KD     | 30.85  | G |
| 103423 | 128.00 | G | 104154 | 26.95  | G  | 112283     | 175.00 | G | 3268TD     | 35.77  | G |
| 103424 | 128.00 | G | 104171 | 59.95  | G  | 112284     | 175.00 | G | 3268XG     | 33.10  | G |
| 103458 | 307.84 | G | 104172 | 59.95  | G  | 10050XS    | 34.29  | G | 3307KD     | 30.85  | G |
| 103459 | 307.84 | G | 104173 | 59.95  | G  | 10100XS    | 34.29  | G | 3327KD     | 30.85  | G |
| 103460 | 307.84 | G | 104179 | 116.17 | G  | 2084M06850 | 122.00 | G | 3347KD     | 30.85  | G |
| 103461 | 128.00 | G | 104183 | 175.15 | G  | 2084M06900 | 122.00 | G | 3367KD     | 30.85  | G |
| 103462 | 128.00 | G | 104187 | 74.35  | G  | 2084M06950 | 132.00 | G | 3464KD     | 30.85  | G |
| 103539 | 277.92 | G | 104188 | 74.35  | G  | 2349M07650 | 118.00 | G | 3937XS     | 34.29  | G |
| 103540 | 277.92 | G | 104192 | 107.38 | G  | 2349M08050 | 128.00 | G | 4707M07400 | 160.00 | G |
| 103541 | 277.92 | G | 104221 | 85.30  | G  | 2394M08100 | 128.00 | G | 718M08500  | 152.00 | G |
| 103557 | 138.00 | G | 104246 | 99.75  | G  | 2559CD     | 34.55  | G | B1003      | 17.50  | G |
| 103558 | 182.00 | G | 104282 | 56.93  | G  | 2598CD     | 34.55  | G | B1014      | 18.50  | G |
| 103559 | 182.00 | G | 104337 | 35.77  | G  | 2697CD     | 34.55  | G | B1021      | 17.50  | G |
| 103560 | 182.00 | G | 104405 | 54.17  | G  | 2717CD     | 34.55  | G | B1022      | 17.50  | G |
| 103561 | 182.00 | G | 104413 | 51.67  | G  | 2736CD     | 34.55  | G | B1023      | 18.50  | G |
| 103569 | 71.24  | G | 104442 | 63.94  | G  | 2746CD     | 34.55  | G | B1024      | 18.50  | G |
| 103570 | 286.02 | G | 104443 | 63.94  | G  | 2766CD     | 34.55  | G | B1030      | 18.50  | G |
| 103571 | 286.02 | G | 104444 | 63.94  | G  | 2786CD     | 34.55  | G | B1031      | 18.50  | G |
| 103572 | 286.02 | G | 104445 | 63.94  | G  | 2795CD     | 34.55  | G | B1039      | 18.50  | G |
| 103635 | 157.35 | G | 104446 | 63.94  | G  | 2805CD     | 34.55  | G | CW16       | 2.00   | G |
| 103652 | 51.45  | G | 104447 | 63.94  | G  | 2815CD     | 34.55  | G | CW17       | 2.00   | G |
| 103663 | 128.00 | G | 104448 | 63.94  | G  | 2835CD     | 34.55  | G | CW18       | 2.00   | G |
| 103664 | 128.00 | G | 104449 | 63.94  | G  | 2854CD     | 34.55  | G | CW20       | 2.00   | G |
| 103665 | 128.00 | G | 104466 | 49.83  | G  | 2874CD     | 34.55  | G | CW21       | 2.00   | G |
| 103715 | 138.00 | G | 104467 | 39.88  | G  | 2894CD     | 34.55  | G | CW22       | 2.00   | G |
| 103716 | 138.00 | G | 104468 | 39.88  | G  | 2913CD     | 34.55  | G | CW24       | 2.00   | G |
| 103717 | 138.00 | G | 104470 | 39.88  | G  | 2913XA     | 35.47  | G | S259       | 16.90  | G |
| 103797 | 182.00 | G | 104471 | 39.88  | G  | 2933TD     | 35.77  | G | S280       | 16.90  | G |
| 103889 | 152.00 | G | 104472 | 39.88  | G  | 2953TD     | 35.77  | G | S343       | 16.90  | G |
| 103928 | 138.00 | G | 104473 | 39.88  | G  | 2973TD     | 35.77  | G | S423       | 16.90  | G |
| 103956 | 128.00 | G | 104493 | 17.90  | G  | 2992TC     | 17.90  | G | S461       | 16.90  | G |
| 103957 | 128.00 | G | 104495 | 17.90  | G  | 2992TD     | 35.77  | G | S477       | 16.90  | G |
| 103958 | 128.00 | G | 104553 | 16.90  | G  | 2992XG     | 33.10  | G | S512       | 16.90  | G |
| 104002 | 186.12 | G | 104570 | 16.90  | G  | 3012TC     | 17.90  | G | S513       | 16.90  | G |
| 104014 | 128.00 | G | 104737 | 18.50  | G  | 3012TD     | 35.77  | G | S532       | 17.67  | G |
| 104015 | 128.00 | G | 104738 | 18.50  | G  | 3012TDW    | 35.77  | G | S539       | 16.90  | G |
| 104016 | 128.00 | G | 104739 | 18.50  | G  | 3032TC     | 17.90  | G | S598       | 17.67  | G |
| 104017 | 152.00 | G | 104740 | 18.50  | G  | 3032TD     | 35.77  | G | S626       | 21.57  | G |
| 104018 | 152.00 | G | 104769 | 14.50  | G  | 3051TD     | 35.77  | G | S631       | 16.90  | G |
| 104019 | 152.00 | G | 111577 | 30.24  | AE | 3071LK     | 45.67  | G | S640       | 16.90  | G |
| 104020 | 152.00 | G | 111618 | 30.85  | G  | 3071TD     | 35.77  | G | S650       | 16.90  | G |
| 104021 | 152.00 | G | 111619 | 30.85  | G  | 3091LK     | 45.67  | G | S662       | 17.67  | G |
| 104022 | 152.00 | G | 111620 | 30.85  | G  | 3091TD     | 35.77  | G | W5294      | 39.29  | G |
| 104023 | 152.00 | G | 111622 | 30.85  | G  | 3110LK     | 45.67  | G |            |        |   |
| 104025 | 96.85  | G | 111695 | 3.40   | AE | 3110TD     | 35.77  | G |            |        |   |





## PERSONAL WATERCRAFT PISTON AND RING SETS

PROX PISTONS are precision machined on the latest, state of the art CNC equipment. The same low-expansion, low-friction piston alloy is used as is used for all major Japanese engine manufacturers. ProX Piston Kits are a first class solution to replace the original piston in your Motorcycle, Scooter, Moped, ATV, Personal Watercraft, etc.

Coated for ultimate performance • Most of the ProX pistons come with a coating. We have developed a new skirt coating that not only assists the wear in process, but also helps reducing friction after the wear in. The black coating is made from a delicate mix of materials and will increase performance.

PROX PISTON RINGS are made by OEM factories to exact specifications. ProX uses well known brands like Rikken Japan, TP and NPR to be sure you will get the quality you might expect from our brand. All ProX piston rings can be used in cast iron bores, nickel ceramic platings (Nikasil), boron composite and electrofusion bores.



|   | PISTON KIT   | SIZE   | PISTON RING  | PISTON PIN, CLIP   | CRANKSHAFT PARTS   | CONNECTING ROD PARTS   | GASKETS                                   | VALVE TRAIN PARTS |
|---|--|--|--|--|--|--|---|-------------------|
| <b>PWC HYDROSPACE</b>   |  |  |  |  |  |  |   |                   |
| Hydrospace S4<br>2005-2009<br>4-Stroke<br><br>Std. Compression 9.0:1<br>Forged Piston | PISTON KIT<br>109547<br>109548<br>109549                               | SIZE<br>84.94<br>84.95<br>84.96                            | RING SET<br>105961<br>105961<br>105961                               |  |  |  |   |                   |
| <b>PWC KAWASAKI</b>   |  |  |  |  |  |  |   |                   |
| JS 300 1986-1988<br>JS 300 SX 1987-1991<br>2-Stroke                                   | PISTON KIT<br>-<br>-<br>-<br>-   | SIZE<br>76.25<br>76.75<br>77.25<br>77.75<br>78.00          | RING SET<br>110200<br>110201<br>110202<br>110203<br>110204           | CLIPS<br>106177<br>(‘86-91)                              | BEARING<br>110758<br>(‘86-91) 2x   | CON. ROD KIT<br>106083<br>(‘86-91)<br>S/E BEARING<br>106814<br>(‘86-91)<br>B/E BEARING<br>110676<br>(‘86-91)<br>CRANKPIN<br>110333<br>(‘86-91) |   |                   |
| JS 440<br>1976-1992<br>2-Stroke   | PISTON KIT<br>109287<br>109288<br>109289<br>109290<br>109291<br>109292 | SIZE<br>68.25<br>68.75<br>69.25<br>69.50<br>69.75<br>70.00 | RING SET<br>110190<br>110191<br>110192<br>-<br>110193<br>-           | PIN<br>106149<br>(‘76-92)<br>CLIPS<br>106174<br>(‘76-92) | BEARING<br>110725<br>Mag Side<br>110760<br>Inner #1&2<br>110725<br>PTO Side  | S/E BEARING<br>106816<br>(‘76-92)  |   |                   |
| JS 550 1982-1988<br>JS 550 SX 1989-1995<br>2-Stroke                                   | PISTON KIT<br>-<br>-<br>-<br>-<br>109294<br>109295                     | SIZE<br>75.25<br>75.50<br>75.75<br>76.25<br>76.75<br>77.00 | RING SET<br>110194<br>110195<br>110196<br>110197<br>110198<br>110199 | PIN<br>106149<br>(‘82-95)<br>CLIPS<br>106174<br>(‘82-95) | BEARING<br>110725<br>Mag Side<br>110760<br>Inner #1&2<br>110725<br>PTO Side  | S/E BEARING<br>106816<br>(‘82-95)  | TOP-END<br>107781<br>(‘91-95)<br>76.00 mm |                   |
| JS 650 SX 1987-1993<br>X-2 1986-1995<br>TS 1989-1996<br>SC 1991-1995<br>2-Stroke      | PISTON KIT<br>-<br>-<br>-<br>-   | SIZE<br>76.25<br>76.75<br>77.25<br>78.00                   | RING SET<br>110200<br>110201<br>110202<br>110204                     | CLIPS<br>106177<br>(‘86-96)                              | BEARING<br>110762<br>Mag Side<br>110762<br>Inner #1<br>110763<br>Inner #2<br>110762<br>PTO Side<br>OILSEAL SET<br>107997<br>(‘86-96) | S/E BEARING<br>106814<br>(‘86-96)<br>B/E BEARING<br>106834<br>(‘86-96)   | TOP-END<br>107782<br>(‘86-96)             |                   |

- accessories
- towables
- body
- controls
- electrical
- driveline
- engine**
- fuel & intake
- chemicals
- tie downs
- tools
- towing & loading

# MARINE



## PWC PISTON AND RING SETS CONTINUED

- accessories
- towables
- body
- controls
- electrical
- driveline
- engine**
- fuel & intake
- chemicals
- tie downs
- tools
- towing & loading

|  | PISTON KIT  | SIZE  | PISTON RING   | PISTON PIN, CLIP   | CRANKSHAFT PARTS  | CONNECTING ROD PARTS   | GASKETS                               | VALVE TRAIN PARTS |
|--|---|---|---|--|---|--|---------------------------------------|-------------------|
| <b>PWC KAWASAKI CONTINUED</b>  |   |   |   |  |   |  |                                       |                   |
| JS 750 SS 1995-1996<br>Supersport 1993-1995<br>750 SX 1992-1995<br>ST 1994-1995<br>XiR 1994<br>2-Stroke  | <b>PISTON KIT</b><br>109296<br>109298                     | <b>SIZE</b><br>80.00<br>81.00<br>81.50          | <b>RING SET</b><br>110205<br>110209<br>110211           | <b>PIN</b><br>110314<br>( '92-96)<br><br><b>CLIPS</b><br>106185<br>( '92-96) | <b>BEARING</b><br>110762<br>Mag Side<br>110762<br>Inner #1<br>110763<br>Inner #2<br>110762<br>PTO Side<br><b>OILSEAL SET</b><br>107997<br>( '92-96) | <b>S/E BEARING</b><br>106817<br>( '92-96)<br><br><b>B/E BEARING</b><br>106839<br>( '92-96)<br><br><b>CRANKPIN</b><br>106214<br>( '92-96)                                       | <b>TOP-END</b><br>107783<br>( '92-00) |                   |
| JS 750 SXi 1995-1996<br>750 STS 1995-1997<br>750 SS 1996-1997<br>Supersport Xi 1996-1997<br>750 ZXi 1995-1997<br>750 STX 1998<br>Xi Sport 1998-1999<br>750 SXi Pro 1998-2002<br>2-Stroke | <b>PISTON KIT</b><br>109302<br>109301<br>109303<br>109304 | <b>SIZE</b><br>80.00<br>80.50<br>81.00<br>81.50 | <b>RING SET</b><br>110205<br>110207<br>110209<br>110211 | <b>PIN</b><br><br><br><b>CLIPS</b><br>106191<br>( '95-02)                    | <b>BEARING</b><br>110762<br>Mag Side<br>110762<br>Inner #1<br>110763<br>Inner #2<br>110762<br>PTO Side<br><b>OILSEAL SET</b><br>107997<br>( '92-02) | <b>CON. ROD KIT</b><br>106091<br>( '95-02)<br><b>S/E BEARING</b><br>106818<br>( '95-02)<br><b>B/E BEARING</b><br>106842<br>( '95-02)<br><b>CRANKPIN</b><br>106218<br>( '95-02) | <b>TOP-END</b><br>107783<br>( '92-02) |                   |
| 800 SX-R<br>2003-2011<br>2-Stroke  | <b>PISTON KIT</b><br>109310<br>109311<br>109312<br>109313 | <b>SIZE</b><br>82.00<br>82.25<br>82.50<br>83.00 | <b>RING SET</b><br>110219<br>110220<br>110221<br>110223 | <b>PIN</b><br><br><br><b>CLIPS</b><br>106191<br>( '03-11)                    | <b>BEARING</b><br>110762<br>Mag Side<br>110762<br>Inner #1<br>110763<br>Inner #2<br>110762<br>PTO Side<br><b>OILSEAL SET</b><br>107997<br>( '03-11) | <b>CON. ROD KIT</b><br>106091<br>( '03-11)<br><b>S/E BEARING</b><br>106818<br>( '03-11)<br><b>B/E BEARING</b><br>106842<br>( '03-11)<br><b>CRANKPIN</b><br>106218<br>( '03-11) | <b>TOP-END</b><br>107786<br>( '03-11) |                   |
| 900 ZXi 1995-1997<br>900 STX 1997-2006<br>900 STS 2001-2002<br>2-Stroke  | <b>PISTON KIT</b><br>109306<br>109307<br>109308<br>109309 | <b>SIZE</b><br>73.00<br>73.25<br>73.50<br>74.00 | <b>RING SET</b><br>110213<br>110214<br>110215<br>110217 | <b>PIN</b><br>110312<br>( '95-06)<br><br><b>CLIPS</b><br>106185<br>( '95-06) | <b>BEARING</b><br>110735<br>Inner #1<br>110787<br>Inner #2, 3 ,4<br>110790<br>PTO Side<br><b>OILSEAL SET</b><br>107998<br>( '95-06)                 | <b>S/E BEARING</b><br>106817<br>( '95-06)<br><b>B/E BEARING</b><br>106839<br>( '95-06)<br><b>CRANKPIN</b><br>106214<br>( '95-06)   | <b>TOP-END</b><br>107785<br>( '95-06) |                   |
| 1100 ZXi 1996-2003<br>1100 STX 1997-1999<br>2-Stroke   | <b>PISTON KIT</b><br>109302<br>109301<br>109303<br>109304 | <b>SIZE</b><br>80.00<br>80.50<br>81.00<br>81.50 | <b>RING SET</b><br>110205<br>110207<br>110209<br>110211 | <b>PIN</b><br><br><br><b>CLIPS</b><br>106191<br>( '96-04)                    | <b>BEARING</b><br>110735<br>Inner #1<br>110787<br>Inner #2, 3 ,4<br>110790<br>PTO Side<br><b>OILSEAL SET</b><br>107998<br>( '96-04)                 | <b>S/E BEARING</b><br>106818<br>( '96-04)  | <b>TOP-END</b><br>107784<br>( '96-04) |                   |



## PWC PISTON AND RING SETS CONTINUED

|   | PISTON KIT                               | SIZE                            | PISTON RING                            | PISTON PIN, CLIP | CRANKSHAFT PARTS   | CONNECTING ROD PARTS              | GASKETS                       | VALVE TRAIN PARTS               |
|---|--|---------------------------------|--|------------------|--|-----------------------------------|-------------------------------|---------------------------------|
| <b>PWC KAWASAKI CONTINUED</b>   |  |                                 |  |                  |  |                                   |                               |                                 |
| Ultra 150 1999-2005<br>STX-R 1200 2002-2005<br>2-Stroke<br>Please Note:<br>Nikasil Piston Size  | PISTON KIT<br>-                          | SIZE<br>80.00                   | RING SET<br>-                          |                  |  |                                   | TOP-END<br>107787<br>(‘99-05) |                                 |
| STX-12F<br>2003-2007<br>4-Stroke<br><br>Std. Compression 11.2:1   | PISTON KIT<br>-                          | SIZE<br>83.00                   | RING SET<br>-                          |                  |  |                                   |                               | CAM CHAIN<br>107413<br>(‘03-07) |
| STX-15F 2004-2014<br>STX 2009-2010<br>Ultra LX 2007-2014<br>4-Stroke<br>Please Note:<br>Nikasil Piston Size<br><br>Std. Compression 10.6:1<br>Forged Piston | PISTON KIT<br>114225<br>114226<br>114227 | SIZE<br>82.95<br>82.96<br>82.97 | RING SET<br>113989<br>113989<br>113989 |                  |  |                                   |                               | CAM CHAIN<br>107413<br>(‘04-05) |
| Ultra 250 X<br>2007-2008<br>4-Stroke<br><br>Std. Compression 7.8:1  | PISTON KIT<br>-                          | SIZE<br>83.00                   | RING SET<br>-                          |                  |  |                                   |                               | CAM CHAIN<br>107415<br>(‘07-08) |
| Ultra 260 X 2009-2010<br>Ultra 260 LX 2009-2010<br>4-Stroke<br>Please Note:<br>Nikasil Piston Size<br><br>Std. Compression 7.8:1<br>Forged Piston           | PISTON KIT<br>114228<br>114229<br>114230 | SIZE<br>82.95<br>82.96<br>82.97 | RING SET<br>113990<br>113990<br>113990 |                  |  |                                   |                               | CAM CHAIN<br>107415<br>(‘09-10) |
| Ultra 300 X 2011-2013<br>Ultra 300 LX 2011-2013<br>4-Stroke<br>Please Note:<br>Nikasil Piston Size<br><br>Std. Compression 8.4:1<br>Forged Piston           | PISTON KIT<br>113876<br>113877<br>113878 | SIZE<br>82.95<br>82.96<br>82.97 | RING SET<br>113990<br>113990<br>113990 |                  |  |                                   |                               |                                 |
| <b>PWC POLARIS</b>  |  |                                 |  |                  |  |                                   |                               |                                 |
| SL 650<br>1992-1995<br>2-Stroke   | PISTON KIT<br>-                          | SIZE<br>65.00                   | RING SET<br>-                          |                  | BEARING<br>110730<br>(‘92-95) 6x<br>110767<br>(‘92-95) 1x<br><br>OILSEAL SET<br>108019<br>(‘92-95) | S/E BEARING<br>106808<br>(‘92-95) |                               |                                 |
| SL/SLT 700 1996-1997<br>SLH/SLTH 700 1998-2004<br>2-Stroke  | PISTON KIT<br>-                          | SIZE<br>81.00                   | RING SET<br>-                          |                  | BEARING<br>110732<br>(‘96-04) 6x   | S/E BEARING<br>106819<br>(‘96-04) | TOP-END<br>107794<br>(‘96-00) |                                 |

- accessories
- towables
- body
- controls
- electrical
- driveline
- engine**
- fuel & intake
- chemicals
- tie downs
- tools
- towing & loading

# MARINE



## PWC PISTON AND RING SETS CONTINUED

- accessories
- towables
- body
- controls
- electrical
- driveline
- engine**
- fuel & intake
- chemicals
- tie downs
- tools
- towing & loading

|  | PISTON KIT                     | SIZE  | PISTON RING  | PISTON PIN, CLIP             | CRANKSHAFT PARTS  | CONNECTING ROD PARTS  | GASKETS                        | VALVE TRAIN PARTS |
|--|--------------------------------|---|--|------------------------------|---|---|--------------------------------|-------------------|
| <b>PWC POLARIS CONTINUED</b>                                   |                                |   |  |                              |   |   |                                |                   |
| SL/SLT 750<br>1993-1995<br>2-Stroke                            | PISTON KIT<br>-                | SIZE<br>69.75                                     | RING SET<br>-  |                              | BEARING<br>110730<br>( '93-95) 6x<br>110767<br>( '93-95) 1x<br><br>OILSEAL SET<br>108019<br>( '93-95)   | S/E BEARING<br>106808<br>( '93-95)  |                                |                   |
| SL/SLT 780<br>1995-1997<br>2-Stroke                            | PISTON KIT<br>-                | SIZE<br>71.30                                     | RING SET<br>-  |                              | BEARING<br>110730<br>( '93-97) 6x<br>110767<br>( '93-97) 1x<br><br>OILSEAL SET<br>108019<br>( '95-97)   | S/E BEARING<br>106808<br>( '95-97)  | TOP-END<br>107795<br>( '95-97) |                   |
| Polaris SL 900<br>1996-1997<br>2-Stroke                        | PISTON KIT<br>-                | SIZE<br>74.50                                     | RING SET<br>-  |                              | BEARING<br>110732<br>( '96-97) 8x   | S/E BEARING<br>106819<br>( '96-97)  | TOP-END<br>107796<br>( '96-97) |                   |
| Polaris SLTX/SLXH 1050<br>1996-1999<br>2-Stroke                | PISTON KIT<br>-                | SIZE<br>81.00                                     | RING SET<br>-  |                              | BEARING<br>110732<br>( '96-99) 8x   | S/E BEARING<br>106819<br>( '96-99)  | TOP-END<br>107797<br>( '96-99) |                   |
| <b>PWC SEA DOO</b>   |                                |   |  |                              |   |   |                                |                   |
| SEA DOO 580 (581cc)<br>1988-1996<br>2-Stroke                   | PISTON KIT<br>-<br>-<br>-<br>- | SIZE<br>76.00<br>76.25<br>76.75<br>77.00<br>77.50 | RING SET<br>110224<br>110225<br>110226<br>110227<br>110228 | CLIPS<br>106179<br>( '88-96) | BEARING<br>110727<br>Mag Side<br>#1, 2<br>110760<br>Inner #1<br>110725<br>Inner #2<br>110734<br>PTO Side<br>#1, 2<br><br>OILSEAL SET<br>108000<br>( '88-96) | CON. ROD KIT<br>106096<br>( '88-96)<br><br>S/E BEARING<br>106788<br>( '88-96)<br><br>B/E BEARING<br><br>106831<br>( '88-96) | TOP-END<br>107788<br>( '92-96) |                   |
| SEA DOO 650 (657cc)<br>XP/GTX/SPI/SPX<br>1993-1995<br>2-Stroke | PISTON KIT<br>-                | SIZE<br>78.00                                     | RING SET<br>-  |                              | BEARING<br>110726<br>Mag Side<br>#1, 2<br>110726<br>Inner #1, 2<br>110734<br>PTO Side<br>#1, 2<br><br>OILSEAL SET<br>108001<br>( '93-95)                    | CON. ROD KIT<br>106097<br>( '93-95)<br><br>S/E BEARING<br>106819<br>( '93-95)<br><br>B/E BEARING<br>106831<br>( '93-95)     | TOP-END<br>107789<br>( '93-95) |                   |



## PWC PISTON AND RING SETS CONTINUED

|   | PISTON KIT                            | SIZE                             | PISTON RING                          | PISTON PIN, CLIP                 | CRANKSHAFT PARTS  | CONNECTING ROD PARTS  | GASKETS   | VALVE TRAIN PARTS |
|---|---------------------------------------|----------------------------------|--------------------------------------|----------------------------------|---|---|---|-------------------|
| <b>PWC SEA DOO CONTINUED</b>                                  |                                       |                                  |                                      |                                  |   |   |   |                   |
| SEA DOO 720 (717cc)<br>XP/GTI/HX/SPX<br>GTS/GS/GSI            | <b>PISTON KIT</b><br>109315<br>109316 | <b>SIZE</b><br>82.00<br>82.25    | <b>RING SET</b><br>110229<br>110230  | <b>PIN</b><br>110313<br>(‘95-05) | <b>BEARING</b><br>110727<br>Mag Side<br>#1, 2<br>110727<br>Inner #1, 2<br>110736<br>PTO Side<br>#1, 2                     | <b>CON. ROD KIT</b><br>106098<br>(‘95-05)<br><br>MAG<br>106099<br>(‘95-05)<br>PTO   | <b>TOP-END</b><br>107790<br>(‘95-05)                                  |                   |
| 1995-2005<br>2-Stroke   | 109317<br>109318<br>109319<br>109320  | 82.50<br>82.75<br>83.00<br>83.50 | 110231<br>110232<br>110233<br>110234 | CLIPS<br>106186<br>(‘95-05)      | <b>OILSEAL SET</b><br>108001<br>(‘95-05)  | <b>S/E BEARING</b><br>106820<br>(‘95-05)<br><br><b>B/E BEARING</b><br>106838<br>(‘95-05)<br><br><b>CRANKPIN</b><br>106212<br>(‘95-05)<br>106213<br>(‘95-05) |   |                   |
| SEA DOO 785 (787cc)<br>XP/SPX/GSX/GTX/<br>GTX-RFI/GTI/GSX-RFI | <b>PISTON KIT</b><br>109323           | <b>SIZE</b><br>82.00<br>82.25    | <b>RING SET</b><br>110229<br>110230  | <b>PIN</b><br>110313<br>(‘95-05) | <b>BEARING</b><br>110736<br>Mag Side<br>#1, 2<br>110736<br>Inner #1 & 2<br>110764<br>PTO Side #1<br>110736<br>PTO Side #2 | <b>CON. ROD KIT</b><br>106100<br>(‘95-05)<br><br>S/E BEARING<br>106820<br>(‘95-05)<br><br><b>B/E BEARING</b><br>106841<br>(‘95-05)                          | <b>TOP-END</b><br>107791<br>(‘95-99)<br><br>107792<br>(‘00-05)<br>RFI |                   |
| 1995-2005<br>2-Stroke   | 109324<br>109325<br>109326            | 82.50<br>82.75<br>83.00<br>83.50 | 110231<br>110232<br>110233<br>110234 | CLIPS<br>106186<br>(‘95-05)      | <b>OILSEAL SET</b><br>108002<br>(‘95-05)  | <b>CRANKPIN</b><br>106216<br>(‘95-05)   |   |                   |
| SEA DOO 950 (951cc)<br>GSX-LTD/XP-LTD<br>GTX-LTD/LRV/RX       | <b>PISTON KIT</b><br>109328<br>109329 | <b>SIZE</b><br>88.00<br>88.25    | <b>RING SET</b><br>110235<br>110236  | <b>PIN</b><br>110316<br>(‘97-05) | <b>BEARING</b><br>110740<br>Mag Side<br>#1, 2<br>110764<br>Inner #1<br>110740<br>Inner #2<br>110740<br>PTO Side<br>#1, 2  | <b>CON. ROD KIT</b><br>106101<br>(‘97-05)<br><br>S/E BEARING<br>106821<br>(‘97-05)<br><br><b>B/E BEARING</b><br>106842<br>(‘97-05)                          | <b>TOP-END</b><br>107793<br>(‘98-00)                                  |                   |
| 1997-2005<br>2-Stroke   | 109330<br>109331<br>109332<br>109333  | 88.50<br>88.75<br>89.00<br>89.50 | 110237<br>110238<br>110239<br>110240 | CLIPS<br>106189<br>(‘97-05)      | <b>OILSEAL SET</b><br>108003<br>(‘97-05)  | <b>CRANKPIN</b><br>106217<br>(‘97-05)   |   |                   |

- accessories
- towables
- body
- controls
- electrical
- driveline
- engine**
- fuel & intake
- chemicals
- tie downs
- tools
- towing & loading

# MARINE



## PWC PISTON AND RING SETS CONTINUED

- accessories
- towables
- body
- controls
- electrical
- driveline
- engine
- fuel & intake
- chemicals
- tie downs
- tools
- towing & loading

|  | PISTON KIT  | SIZE   | PISTON RING   | PISTON PIN, CLIP   | CRANKSHAFT PARTS   | CONNECTING ROD PARTS  | GASKETS | VALVE TRAIN PARTS   |
|--|---|--|---|--|--|---|---------|---|
| <b>PWC SEA DOO CONTINUED</b>   |   |  |   |  |  |   |         |   |
| SEA DOO 1500 RXP<br>2004-2009<br>4-Stroke<br>Std. Compression 8.4:1<br>Forged Piston     | <b>PISTON KIT</b><br>109334<br>109335<br>109336   | <b>SIZE</b><br>100.00<br>100.50<br>101.00                                  | <b>RING SET</b><br>110241<br>110242<br>110243   | <b>PIN</b><br>113395<br>(*04-09)<br><br><b>CLIPS</b><br>113984<br>(*04-09) |  |   |         | <b>VALVE</b><br>111033<br>(*04-09) Exhaust Steel<br>111034<br>(*04-09) Intake Steel |
| SEA DOO 1500 RXT<br>2005-2009<br>4-Stroke<br>Std. Compression 8.4:1<br>Forged Piston     | <b>PISTON KIT</b><br>109334<br>109335<br>109336   | <b>SIZE</b><br>100.00<br>100.50<br>101.00                                  | <b>RING SET</b><br>110241<br>110242<br>110243   | <b>PIN</b><br>113395<br>(*05-09)<br><br><b>CLIPS</b><br>113984<br>(*05-09) |  |   |         | <b>VALVE</b><br>111033<br>(*05-09) Exhaust Steel<br>111034<br>(*05-09) Intake Steel |
| SEA DOO RXP-X 255<br>2008-2009<br>4-Stroke<br>Std. Compression 8.4:1<br>Forged Piston    | <b>PISTON KIT</b><br>109334<br>109335<br>109336   | <b>SIZE</b><br>100.00<br>100.50<br>101.00                                  | <b>RING SET</b><br>110241<br>110242<br>110243   | <b>PIN</b><br>113395<br>(*08-09)<br><br><b>CLIPS</b><br>113984<br>(*08-09) |  |   |         | <b>VALVE</b><br>111033<br>(*08-09) Exhaust Steel<br>111034<br>(*08-09) Intake Steel |
| SEA DOO RXT-X 260 RS<br>2010-2014<br>4-Stroke<br>Std. Compression 8.4:1<br>Forged Piston | <b>PISTON KIT</b><br>109334<br>109335<br>109336   | <b>SIZE</b><br>100.00<br>100.50<br>101.00                                  | <b>RING SET</b><br>110241<br>110242<br>110243   | <b>PIN</b><br>113395<br>(*10-14)<br><br><b>CLIPS</b><br>113984<br>(*10-14) |  |   |         | <b>VALVE</b><br>111033<br>(*10-14) Exhaust Steel<br>111034<br>(*10-14) Intake Steel |
| <b>PWC YAMAHA</b>  |   |  |   |  |  |   |         |   |
| Watercraft 500<br>2-Stroke   | <b>PISTON KIT</b><br>-  | <b>SIZE</b><br>-   | <b>RING SET</b><br>-  |  | <b>OILSEAL SET</b><br>107961   |   |         |   |
| Superjet 650 1990-1993<br>Wave Runner 650 '90-96<br>2-Stroke                             | <b>PISTON KIT</b><br>-<br>-<br>-<br>-   | <b>SIZE</b><br>77.50<br>77.75<br>78.00<br>78.25<br>78.50                   | <b>RING SET</b><br>110036<br>110037<br>110038<br>110039<br>110040                     | <b>PIN</b><br>110311<br>(*90-96)<br><br><b>CLIPS</b><br>106183<br>(*90-96) | <b>CRANKWEB</b><br>106233<br>(*90-96)<br><b>BEARING</b><br>110792<br>Mag Side<br>110793<br>PTO Side<br>110737<br>Inner #1, 2<br><b>OILSEAL SET</b><br>107962<br>(*90-96) | <b>S/E BEARING</b><br>106801<br>(*90-96)<br><b>B/E BEARING</b><br>106837<br>(*90-96)<br><b>CRANKPIN</b><br>110337<br>(*90-96) |         | <b>TOP-END</b><br>107709<br>(*90-96)  |
| BIG BORE 650<br>1990-1996<br>2-Stroke  | <b>PISTON KIT</b><br>108761<br>108762<br>108763<br>108764<br>108765<br>108766<br>108767 | <b>SIZE</b><br>81.00<br>81.25<br>81.50<br>81.75<br>82.00<br>82.50<br>83.00 | <b>RING SET</b><br>110041<br>110042<br>110043<br>110044<br>110045<br>110046<br>110047 | <b>PIN</b><br>110315<br>(*90-96)<br><br><b>CLIPS</b><br>106182<br>(*90-96) | <b>CRANKWEB</b><br>106233<br>(*90-96)<br><b>BEARING</b><br>110793<br>PTO Side<br>110737<br>Inner #1, 2<br><b>OILSEAL SET</b><br>107962<br>(*90-96)                       | <b>S/E BEARING</b><br>106801<br>(*90-96)<br><b>B/E BEARING</b><br>106837<br>(*90-96)<br><b>CRANKPIN</b><br>110337<br>(*90-96) |         |   |



## PWC PISTON AND RING SETS CONTINUED

|  | PISTON KIT        | SIZE         | PISTON RING     | PISTON PIN, CLIP | CRANKSHAFT PARTS   | CONNECTING ROD PARTS | GASKETS         | VALVE TRAIN PARTS |
|--|-------------------|--------------|-----------------|------------------|--------------------|----------------------|-----------------|-------------------|
| <b>PWC YAMAHA CONTINUED</b>                                    |                   |              |                 |                  |                    |                      |                 |                   |
| Superjet 700 1994-2014   | <b>PISTON KIT</b> | <b>SIZE</b>  | <b>RING SET</b> | <b>PIN</b>       | <b>CRANKWEB</b>    | <b>S/E BEARING</b>   | <b>TOP-END</b>  |                   |
| Wave Blaster 700 '93-04  | <b>108761</b>     | <b>81.00</b> | <b>110041</b>   | <b>110315</b>    | <b>106233</b>      | <b>106801</b>        | <b>107710</b>   |                   |
| Wave Raider 700 '94-97   | <b>108762</b>     | <b>81.25</b> | <b>110042</b>   | <b>('93-14)</b>  | <b>('93-14)</b>    | <b>('93-14)</b>      | <b>('93-95)</b> |                   |
| Wave Runner 700 '93-04   | <b>108763</b>     | <b>81.50</b> | <b>110043</b>   |                  |                    |                      | <b>SJ</b>       |                   |
| Wave Venture 700 '95-04  | <b>108764</b>     | <b>81.75</b> | <b>110044</b>   | <b>CLIPS</b>     | <b>BEARING</b>     | <b>B/E BEARING</b>   | <b>107711</b>   |                   |
| XL 700 1995-2005   | <b>108765</b>     | <b>82.00</b> | <b>110045</b>   | <b>106182</b>    | <b>110792</b>      | <b>106837</b>        | <b>('94-96)</b> |                   |
| 2-Stroke   | <b>108766</b>     | <b>82.50</b> | <b>110046</b>   | <b>('93-14)</b>  | <b>Mag Side</b>    | <b>('93-14)</b>      | <b>WR/WV</b>    |                   |
|  | <b>108767</b>     | <b>83.00</b> | <b>110047</b>   |                  | <b>110793</b>      |                      | <b>107713</b>   |                   |
|  |                   |              |                 |                  | <b>PTO Side</b>    | <b>CRANKPIN</b>      | <b>('96-14)</b> |                   |
|  |                   |              |                 |                  | <b>110737</b>      | <b>110337</b>        | <b>SJ</b>       |                   |
|  |                   |              |                 |                  | <b>Inner #1, 2</b> | <b>('93-14)</b>      |                 |                   |
|  |                   |              |                 |                  | <b>OILSEAL SET</b> |                      |                 |                   |
|  |                   |              |                 |                  | <b>107962</b>      |                      |                 |                   |
|  |                   |              |                 |                  | <b>('93-14)</b>    |                      |                 |                   |
| GP 760 1996-2000   | <b>PISTON KIT</b> | <b>SIZE</b>  | <b>RING SET</b> | <b>PIN</b>       | <b>CRANKWEB</b>    | <b>S/E BEARING</b>   | <b>TOP-END</b>  |                   |
| Wave Blaster 760 '96-00  | <b>108768</b>     | <b>84.00</b> | <b>110048</b>   | <b>110315</b>    | <b>106233</b>      | <b>106801</b>        | <b>107716</b>   |                   |
| Wave Raider 760 '96-00   | <b>108769</b>     | <b>84.25</b> | <b>110049</b>   | <b>('96-00)</b>  | <b>('96-00)</b>    | <b>('96-00)</b>      | <b>('96-00)</b> |                   |
| Wave Runner 760 '96-00   | <b>108770</b>     | <b>84.50</b> | <b>110050</b>   |                  |                    |                      |                 |                   |
| Wave Venture 760 '96-00  | <b>108771</b>     | <b>84.75</b> | <b>110051</b>   | <b>CLIPS</b>     | <b>BEARING</b>     | <b>B/E BEARING</b>   |                 |                   |
| XL 760 1996-2000   | <b>108772</b>     | <b>85.00</b> | <b>110052</b>   | <b>106183</b>    | <b>110792</b>      | <b>106837</b>        |                 |                   |
| 2-Stroke   | <b>108773</b>     | <b>85.50</b> | <b>110053</b>   | <b>('96-00)</b>  | <b>Mag Side</b>    | <b>('96-00)</b>      |                 |                   |
|  | -                 | <b>86.00</b> | <b>110054</b>   |                  | <b>110793</b>      |                      |                 |                   |
|  |                   |              |                 |                  | <b>PTO Side</b>    | <b>CRANKPIN</b>      |                 |                   |
|  |                   |              |                 |                  | <b>110737</b>      | <b>110337</b>        |                 |                   |
|  |                   |              |                 |                  | <b>Inner #1, 2</b> | <b>('96-00)</b>      |                 |                   |
|  |                   |              |                 |                  | <b>OILSEAL SET</b> |                      |                 |                   |
|  |                   |              |                 |                  | <b>107962</b>      |                      |                 |                   |
|  |                   |              |                 |                  | <b>('96-00)</b>    |                      |                 |                   |
| GP 800 R 1998-2005   | <b>PISTON KIT</b> | <b>SIZE</b>  | <b>RING SET</b> | <b>PIN</b>       | <b>BEARING</b>     | <b>CON. ROD KIT</b>  | <b>TOP-END</b>  |                   |
| XL 800 2000-2001   | <b>108776</b>     | <b>79.90</b> | <b>105895</b>   | <b>106165</b>    | <b>106847</b>      | <b>106037</b>        | <b>107717</b>   |                   |
| XLT 800 2002-2004  | <b>108777</b>     | <b>79.91</b> | <b>105895</b>   | <b>('98-05)</b>  | <b>Mag Side</b>    | <b>('98-05)</b>      | <b>('98-05)</b> |                   |
| 2-Stroke   | <b>108778</b>     | <b>79.92</b> | <b>105895</b>   |                  | <b>110771</b>      |                      |                 |                   |
| Please Note:   | <b>108779</b>     | <b>79.93</b> | <b>105895</b>   | <b>CLIPS</b>     | <b>PTO Side</b>    | <b>S/E BEARING</b>   |                 |                   |
| Nikasil Piston Size  | <b>&amp;</b>      |              |                 | <b>106190</b>    | <b>110740</b>      | <b>106802</b>        |                 |                   |
|  | <b>108774</b>     | <b>80.50</b> | <b>110055</b>   | <b>('98-05)</b>  | <b>Inner #1, 2</b> | <b>('98-05)</b>      |                 |                   |
| Replating<br>or<br>Cylinder Sleaving<br>Required for Oversizes |                   |              |                 |                  | <b>OILSEAL SET</b> | <b>B/E BEARING</b>   |                 |                   |
|  |                   |              |                 |                  | <b>107963</b>      | <b>106840</b>        |                 |                   |
|  |                   |              |                 |                  | <b>('98-05)</b>    | <b>('98-05)</b>      |                 |                   |
|  |                   |              |                 |                  |                    | <b>CRANKPIN</b>      |                 |                   |
|  |                   |              |                 |                  |                    | <b>110339</b>        |                 |                   |
|  |                   |              |                 |                  |                    | <b>('98-05)</b>      |                 |                   |

- accessories
- towables
- body
- controls
- electrical
- driveline
- engine**
- fuel & intake
- chemicals
- tie downs
- tools
- towing & loading

# MARINE



## PWC PISTON AND RING SETS CONTINUED

- accessories
- towables
- body
- controls
- electrical
- driveline
- engine**
- fuel & intake
- chemicals
- tie downs
- tools
- towing & loading

|  | PISTON KIT        | SIZE        | PISTON RING     | PISTON PIN, CLIP | CRANKSHAFT PARTS   | CONNECTING ROD PARTS | GASKETS        | VALVE TRAIN PARTS |
|--|-------------------|-------------|-----------------|------------------|--------------------|----------------------|----------------|-------------------|
| <b>PWC YAMAHA CONTINUED</b>                                    |                   |             |                 |                  |                    |                      |                |                   |
| Wave Runner 1100   | <b>PISTON KIT</b> | <b>SIZE</b> | <b>RING SET</b> | <b>PIN</b>       | <b>CRANKWEB</b>    | <b>S/E BEARING</b>   | <b>TOP-END</b> |                   |
| Wave Venture 1100  | 108761            | 81.00       | 110041          | 110315           | 106233             | 106801               | 107712         |                   |
| 1995-1997  | 108762            | 81.25       | 110042          | ('95-97)         | ('95-97)           | ('95-97)             | ('95-97)       |                   |
| 2-Stroke Triple  | 108763            | 81.50       | 110043          |                  |                    |                      |                |                   |
|  | 108764            | 81.75       | 110044          | <b>CLIPS</b>     | <b>BEARING</b>     | <b>B/E BEARING</b>   |                |                   |
|  | 108765            | 82.00       | 110045          | 106182           | 110792             | 106837               |                |                   |
|  | 108766            | 82.50       | 110046          | ('95-97)         | Mag Side           | ('95-97)             |                |                   |
|  | 108767            | 83.00       | 110047          |                  | 110793             |                      |                |                   |
|  |                   |             |                 |                  | PTO Side           | <b>CRANKPIN</b>      |                |                   |
|  |                   |             |                 |                  | 110737             | 110337               |                |                   |
|  |                   |             |                 |                  | Inner #1, 2, 3, 4  | ('95-97)             |                |                   |
|  |                   |             |                 |                  | <b>OILSEAL SET</b> |                      |                |                   |
|  |                   |             |                 |                  | 107962             |                      |                |                   |
|  |                   |             |                 |                  | ('95-97)           |                      |                |                   |
| GP 1200 1997-1999  | <b>PISTON KIT</b> | <b>SIZE</b> | <b>RING SET</b> | <b>PIN</b>       | <b>CRANKWEB</b>    | <b>S/E BEARING</b>   | <b>TOP-END</b> |                   |
| XL 1200 1997-1999  | 108768            | 84.00       | 110048          | 110315           | 106233             | 106801               | 107714         |                   |
| SUV 1200 1999-2004   | 108769            | 84.25       | 110049          | ('97-04)         | ('97-04)           | ('97-04)             | ('97-04)       |                   |
| 2-Stroke Triple  | 108770            | 84.50       | 110050          |                  |                    |                      |                |                   |
|  | 108771            | 84.75       | 110051          | <b>CLIPS</b>     | <b>BEARING</b>     | <b>B/E BEARING</b>   |                |                   |
|  | 108772            | 85.00       | 110052          | 106183           | 110792             | 106837               |                |                   |
|  | 108773            | 85.50       | 110053          | ('97-04)         | Mag Side           | ('97-04)             |                |                   |
|  | -                 | 86.00       | 110054          |                  | 110737             |                      |                |                   |
|  |                   |             |                 |                  | Inner #1, 2, 3, 4  | <b>CRANKPIN</b>      |                |                   |
|  |                   |             |                 |                  | 110793             | 110337               |                |                   |
|  |                   |             |                 |                  | PTO Side           | ('97-04)             |                |                   |
|  |                   |             |                 |                  | <b>OILSEAL SET</b> |                      |                |                   |
|  |                   |             |                 |                  | 107962             |                      |                |                   |
|  |                   |             |                 |                  | ('97-04)           |                      |                |                   |
| XL 1200 LTD 1998-2001  | <b>PISTON KIT</b> | <b>SIZE</b> | <b>RING SET</b> | <b>PIN</b>       | <b>BEARING</b>     | <b>CON. ROD KIT</b>  | <b>TOP-END</b> |                   |
| GP 1200 R 2000-2003  | 108776            | 79.90       | 105895          | 106165           | 110693             | 106037               | 107715         |                   |
| XLT 1200 2001-2005   | 108777            | 79.91       | 105895          | ('98-05)         | Mag Side           | ('98-05)             | ('98-05)       |                   |
| 2-Stroke Triple  | 108778            | 79.92       | 105895          |                  | 110771             |                      |                |                   |
| Please Note:   | 108779            | 79.93       | 105895          | <b>CLIPS</b>     | PTO Side           | <b>S/E BEARING</b>   |                |                   |
| Nikasil Piston Size  | &                 |             |                 | 106190           | 110740             | 106802               |                |                   |
|  | 108774            | 80.50       | 110055          | ('98-05)         | Inner #1, 2, 3, 4  | ('98-05)             |                |                   |
| Replating<br>or<br>Cylinder Sleeving<br>Required for Oversizes |                   |             |                 |                  | <b>OILSEAL SET</b> | <b>B/E BEARING</b>   |                |                   |
|  |                   |             |                 |                  | 107964             | 106840               |                |                   |
|  |                   |             |                 |                  | ('98-05)           | ('98-05)             |                |                   |
|  |                   |             |                 |                  |                    | <b>CRANKPIN</b>      |                |                   |
|  |                   |             |                 |                  |                    | 110339               |                |                   |
|  |                   |             |                 |                  |                    | ('98-05)             |                |                   |





## PWC PISTON AND RING SETS CONTINUED

|  | PISTON KIT                                      | SIZE                                   | PISTON RING                                   | PISTON PIN, CLIP   | CRANKSHAFT PARTS   | CONNECTING ROD PARTS   | GASKETS | VALVE TRAIN PARTS                      |
|--|---|--|---|--|--|--|---------|--|
| <b>PWC YAMAHA CONTINUED</b>  |   |  |   |  |  |  |         |  |
| GP 1300 R<br>2003-2008<br>2-Stroke Triple<br>Please Note:<br>Nikasil Piston Size<br><br>Forged Piston  | <b>PISTON KIT</b><br>108781<br>108782<br>108783 | <b>SIZE</b><br>83.90<br>83.91<br>83.92 | <b>RING SET</b><br>105896<br>105896<br>105896 | <b>PIN</b><br>106165<br>(*03-08)<br><br><b>CLIPS</b><br>106190<br>(*03-08) | <b>BEARING</b><br>110693<br>Mag Side<br>110771<br>PTO Side<br>110740<br>Inner #1, 2,<br>3, 4 | <b>CON. ROD KIT</b><br>106037<br>(*03-08)<br><br><b>S/E BEARING</b><br>106802<br>(*03-08)<br><br><b>B/E BEARING</b><br>106840<br>(*03-08)<br><br><b>CRANKPIN</b><br>110339<br>(*03-08) |         |  |
| FX 140 / FX 140 Cruiser<br>2003-2006<br>4-Stroke<br>Please Note:<br>Nikasil Piston Size<br><br>Replating<br>or<br>Cylinder Sleeving<br>Required for Oversizes<br><br>Forged Piston             | <b>PISTON KIT</b><br>108785                     | <b>SIZE</b><br>75.00                   | <b>RING SET</b><br>-                          |  |  |  |         | <b>CAM CHAIN</b><br>107374<br>(*03-08) |
| VX110 Deluxe 2005-2014<br>VX110 Sport 2005-2014<br>VX110 Cruiser 2007-2014<br>4-Stroke<br>Please Note:<br>Nikasil Piston Size<br><br>4 Cylinder<br>Forged Piston<br>Std. Compression 11.4:1    | <b>PISTON KIT</b><br>114222<br>114223<br>114224 | <b>SIZE</b><br>75.95<br>75.96<br>75.97 | <b>RING SET</b><br>-<br>-<br>-                |  |  |  |         |  |
| FX SHO 2008-2014<br>FX Cruiser SHO 2008-2014<br>FZR 2009-2013<br>FZS 2009-2013<br>4-Stroke<br>Please Note:<br>Nikasil Piston Size<br><br>4 Cylinder<br>Forged Piston<br>Std. Compression 8.6:1 | <b>PISTON KIT</b><br>113847<br>113848<br>113849 | <b>SIZE</b><br>85.95<br>85.96<br>95.97 | <b>RING SET</b><br>-<br>-<br>-                |  |  |  |         |  |

- accessories
- towables
- body
- controls
- electrical
- driveline
- engine**
- fuel & intake
- chemicals
- tie downs
- tools
- towing & loading

# MARINE

# ENGINE

## PERSONAL WATERCRAFT ORIGINAL & PLATINUM SERIES PISTON KITS



Cast piston. Original Series piston made to exact OEM specifications. Can be used along with original factory piston meaning you can just replace one piston if you wish. Complete kits include all pistons, rings, clips, wrist pins, gasket kit & top end bearings. Individual kits include one piston, rings, clips and wrist pin.

Available in Original Series and Platinum Series kits. Original Series pistons are made to exact OEM specifications. Platinum Series pistons are made of high strength hardened aluminum designed to prevent skirt and ring groove breakage. Piston walls are treated with a nonabrasive coating which reduces heat and friction for extended life.



| MODEL                  | YEAR  | PISTON        |              | SIZE | PISTON BORE | RING SET |               | RING END GAP |   |            |
|------------------------|-------|---------------|--------------|------|-------------|----------|---------------|--------------|---|------------|
| <b>KAWASAKI</b>        |       |               |              |      |             |          |               |              |   |            |
| 300 SX                 | 86-91 | <b>327855</b> | <b>69.60</b> | L    | Std.        | 76mm     | <b>328528</b> | <b>21.00</b> | L | .007-.0163 |
|                        |       | <b>327846</b> | <b>69.60</b> | L    | .25mm       |          | <b>328529</b> | <b>21.00</b> | L |            |
|                        |       | <b>327847</b> | <b>69.60</b> | L    | .5mm        |          | <b>328530</b> | <b>21.00</b> | L |            |
|                        |       | <b>327848</b> | <b>69.60</b> | L    | .75mm       |          | <b>328531</b> | <b>21.00</b> | L |            |
|                        |       | <b>327849</b> | <b>69.60</b> | L    | 1mm         |          | <b>328532</b> | <b>21.00</b> | L |            |
| 550                    | 82-90 | <b>327867</b> | <b>65.90</b> | L    | Std.        | 75mm     | <b>328538</b> | <b>17.05</b> | L | .008-.016  |
|                        |       | <b>327858</b> | <b>65.90</b> | L    | .25mm       |          | <b>328539</b> | <b>17.05</b> | L |            |
|                        |       | <b>327859</b> | <b>65.90</b> | L    | .5mm        |          | <b>328540</b> | <b>17.05</b> | L |            |
|                        |       | <b>327860</b> | <b>65.90</b> | L    | .75mm       |          | <b>328541</b> | <b>17.05</b> | L |            |
|                        |       | <b>327861</b> | <b>65.90</b> | L    | 1mm         |          | <b>328542</b> | <b>17.05</b> | L |            |
| 650                    | All   | <b>327855</b> | <b>69.60</b> | L    | Std.        | 76mm     | <b>328528</b> | <b>21.00</b> | L | .007-.016  |
|                        |       | <b>327846</b> | <b>69.60</b> | L    | .25mm       |          | <b>328529</b> | <b>21.00</b> | L |            |
|                        |       | <b>327847</b> | <b>69.60</b> | L    | .5mm        |          | <b>328530</b> | <b>21.00</b> | L |            |
|                        |       | <b>327848</b> | <b>69.60</b> | L    | .75mm       |          | <b>328531</b> | <b>21.00</b> | L |            |
|                        |       | <b>327849</b> | <b>69.60</b> | L    | 1mm         |          | <b>328532</b> | <b>21.00</b> | L |            |
| 750 SS                 | 92-95 | <b>328133</b> | <b>75.10</b> | L    | Std.        | 80mm     | <b>328566</b> | <b>29.75</b> | L | .010-.020  |
| 750 SSXi               | 93-95 | <b>327989</b> | <b>75.10</b> | L    | .25mm       |          | <b>328567</b> | <b>29.75</b> | L |            |
| 750 ST                 | 94-95 | <b>327991</b> | <b>75.10</b> | L    | .5mm        | 20mm Pin | <b>328568</b> | <b>29.75</b> | L |            |
| 750 SX                 | 92-95 | <b>327993</b> | <b>75.10</b> | L    | .75mm       |          | <b>328569</b> | <b>29.75</b> | L |            |
| 750 XiR                | 94    | <b>327995</b> | <b>75.10</b> | L    | 1mm         |          | <b>328570</b> | <b>29.75</b> | L |            |
| <b>Platinum Series</b> |       |               |              |      |             |          |               |              |   |            |
| 750 SS                 | 92-95 | <b>328134</b> | <b>83.45</b> | L    | Std.        | 80mm     | <b>328566</b> | <b>29.75</b> | L | .010-.020  |
| 750 SSXi               | 93-95 | <b>327990</b> | <b>83.45</b> | L    | .25mm       |          | <b>328567</b> | <b>29.75</b> | L |            |
| 750 ST                 | 94-95 | <b>327992</b> | <b>83.45</b> | L    | .5mm        | 20mm Pin | <b>328568</b> | <b>29.75</b> | L |            |
| 750 SX                 | 92-95 | <b>327994</b> | <b>83.45</b> | L    | .75mm       |          | <b>328569</b> | <b>29.75</b> | L |            |
| 750 XiR                | 94    | <b>327996</b> | <b>83.45</b> | L    | 1mm         |          | <b>328570</b> | <b>29.75</b> | L |            |
| 750 SS, SSXi           | 96-97 | <b>328163</b> | <b>80.10</b> | L    | Std.        | 80mm     | <b>328566</b> | <b>29.75</b> | L | .010-.020  |
| 750 STS, ZXi           | 95-97 | <b>328135</b> | <b>80.10</b> | L    | .25mm       |          | <b>328567</b> | <b>29.75</b> | L |            |
| 750 STX                | 98    | <b>328137</b> | <b>80.10</b> | L    | .5mm        | 22mm Pin | <b>328568</b> | <b>29.75</b> | L |            |
| 750 SXi                | 95-96 | <b>328139</b> | <b>80.10</b> | L    | .75mm       |          | <b>328569</b> | <b>29.75</b> | L |            |
| 750 SXi Pro            | 98-02 | <b>328141</b> | <b>80.10</b> | L    | 1mm         |          | <b>328570</b> | <b>29.75</b> | L |            |
| 750 Xi-Sport           | 98-99 |               |              |      |             |          |               |              |   |            |
| 750 ZXi                | 95-97 |               |              |      |             |          |               |              |   |            |
| <b>Platinum Series</b> |       |               |              |      |             |          |               |              |   |            |
| 750 SS, SSXi           | 96-97 | <b>328164</b> | <b>86.80</b> | L    | Std.        | 80mm     | <b>328566</b> | <b>29.75</b> | L | .010-.020  |
| 750 STS, ZXi           | 95-97 | <b>328136</b> | <b>86.80</b> | L    | .25mm       |          | <b>328567</b> | <b>29.75</b> | L |            |
| 750 STX                | 98    | <b>328138</b> | <b>86.80</b> | L    | .5mm        | 22mm Pin | <b>328568</b> | <b>29.75</b> | L |            |
| 750 SXi                | 95-96 | <b>328140</b> | <b>86.80</b> | L    | .75mm       |          | <b>328569</b> | <b>29.75</b> | L |            |
| 750 SXi Pro            | 98-02 | <b>328142</b> | <b>86.80</b> | L    | 1mm         |          | <b>328570</b> | <b>29.75</b> | L |            |
| 750 Xi-Sport           | 98-99 |               |              |      |             |          |               |              |   |            |

MARINE



## PWC ORIGINAL & PLATINUM PISTON KITS CONTINUED

| MODEL  | YEAR           | PISTON |       |   | SIZE  | PISTON BORE | RING SET |       |   | RING END GAP |
|--|----------------|--------|-------|---|-------|-------------|----------|-------|---|--------------|
| <b>KAWASAKI CONTINUED</b>                                  |                |        |       |   |       |             |          |       |   |              |
| 800 SX-R   | 03-11          | 328452 | 86.80 | L | Std.  | 82mm        | 328636   | 28.40 | L | .010-.020    |
|  |                | 328434 | 86.80 | L | .25mm |             | 328637   | 28.40 | L |              |
|  |                | 328436 | 86.80 | L | .5mm  |             | 328638   | 28.40 | L |              |
|  |                | 328438 | 86.80 | L | .75mm |             | 328639   | 28.40 | L |              |
|  |                | 328440 | 86.80 | L | 1mm   |             | 328640   | 28.40 | L |              |
| <i>Platinum Series</i><br>800 SX-R                         | 03-11          | 328453 | 91.80 | L | Std.  | 82mm        | 328636   | 28.40 | L | .010-.020    |
|  |                | 328435 | 91.80 | L | .25mm |             | 328637   | 28.40 | L |              |
|  |                | 328437 | 91.80 | L | .5mm  |             | 328638   | 28.40 | L |              |
|  |                | 328439 | 91.80 | L | .75mm |             | 328639   | 28.40 | L |              |
|  |                | 328441 | 91.80 | L | 1mm   |             | 328640   | 28.40 | L |              |
| 900 STX  | 97-06          | 328392 | 75.10 | L | Std.  | 73mm        | 328631   | 24.50 | L | .010-.016    |
|  |                | 328374 | 75.10 | L | .25mm |             | 328632   | 24.50 | L |              |
|  |                | 328376 | 75.10 | L | .5mm  |             | 328633   | 24.50 | L |              |
|  |                | 328378 | 75.10 | L | .75mm |             | 328634   | 24.50 | L |              |
|  |                | 328380 | 75.10 | L | 1mm   |             | 328635   | 24.50 | L |              |
| <i>Platinum Series</i><br>900 STX                          | 97-06          | 328393 | 83.45 | L | Std.  | 73mm        | 328631   | 24.50 | L | .010-.016    |
|  |                | 328375 | 83.45 | L | .25mm |             | 328632   | 24.50 | L |              |
|  |                | 328377 | 83.45 | L | .5mm  |             | 328633   | 24.50 | L |              |
|  |                | 328379 | 83.45 | L | .75mm |             | 328634   | 24.50 | L |              |
|  |                | 328381 | 83.45 | L | 1mm   |             | 328635   | 24.50 | L |              |
| 1100 STX   | 97-99          | 328163 | 80.10 | L | Std.  | 80mm        | 328566   | 29.75 | L | .010-.020    |
| 1100 ZXi   | 96-03          | 328135 | 80.10 | L | .25mm |             | 328567   | 29.75 | L |              |
|  |                | 328137 | 80.10 | L | .5mm  |             | 328568   | 29.75 | L |              |
|  |                | 328139 | 80.10 | L | .75mm |             | 328569   | 29.75 | L |              |
|  |                | 328141 | 80.10 | L | 1mm   |             | 328570   | 29.75 | L |              |
| <i>Platinum Series</i><br>1100 STX<br>1100 ZXi             | 97-99<br>96-03 | 328164 | 86.80 | L | Std.  | 80mm        | 328566   | 29.75 | L | .010-.020    |
|  |                | 328136 | 86.80 | L | .25mm |             | 328567   | 29.75 | L |              |
|  |                | 328138 | 86.80 | L | .5mm  |             | 328568   | 29.75 | L |              |
|  |                | 328140 | 86.80 | L | .75mm |             | 328569   | 29.75 | L |              |
|  |                | 328142 | 86.80 | L | 1mm   |             | 328570   | 29.75 | L |              |
| 1100 STX DI<br>1100 Ultra 130 DI<br>01-04                  | 00-03          | 328432 | 89.45 | N | Std.  | 80mm        | 328566   | 29.75 | L | .010-.020    |
|  |                | 328414 | 84.85 | L | .25mm |             | 328567   | 29.75 | L |              |
|  |                | 328416 | 84.85 | L | .5mm  |             | 328568   | 29.75 | L |              |
|  |                | 328418 | 84.85 | L | .75mm |             | 328569   | 29.75 | L |              |
|  |                | 328420 | 84.85 | L | 1mm   |             | 328570   | 29.75 | L |              |
| <i>Platinum Series</i><br>1100 STX DI<br>1100 Ultra 130 DI | 00-03<br>01-04 | 328433 | 89.45 | L | Std.  | 80mm        | 328566   | 29.75 | L | .010-.020    |
|  |                | 328415 | 89.45 | L | .25mm |             | 328567   | 29.75 | L |              |
|  |                | 328417 | 89.45 | L | .5mm  |             | 328568   | 29.75 | L |              |
|  |                | 328419 | 89.45 | L | .75mm |             | 328569   | 29.75 | L |              |
|  |                | 328421 | 89.45 | L | 1mm   |             | 328570   | 29.75 | L |              |
| 1200 Ultra 150<br>1200 STX-R                               | 99-05<br>02-05 | 328412 | 83.45 | L | Std.  | 79.87mm     | 328566   | 29.75 | L | .010-.020    |
|  |                | 328394 | 83.45 | L | .25mm |             | 328567   | 29.75 | L |              |
|  |                | 328396 | 83.45 | L | .5mm  |             | 328568   | 29.75 | L |              |
|  |                | 328398 | 83.45 | L | .75mm |             | 328569   | 29.75 | L |              |
|  |                | 328400 | 83.45 | L | 1mm   |             | 328570   | 29.75 | L |              |
| <i>Platinum Series</i><br>1200 Ultra 150<br>1200 STX-R     | 99-05<br>02-05 | 328413 | 91.80 | L | Std.  | 79.87mm     | 328566   | 29.75 | L | .010-.020    |
|  |                | 328395 | 91.80 | L | .25mm |             | 328567   | 29.75 | L |              |
|  |                | 328397 | 91.80 | L | .5mm  |             | 328568   | 29.75 | L |              |
|  |                | 328399 | 91.80 | L | .75mm |             | 328569   | 29.75 | L |              |
|  |                | 328401 | 91.80 | L | 1mm   |             | 328570   | 29.75 | L |              |

- accessories
- towables
- body
- controls
- electrical
- driveline
- engine**
- fuel & intake
- chemicals
- tie downs
- tools
- towing & loading

# MARINE



## PWC ORIGINAL & PLATINUM PISTON KITS CONTINUED

| MODEL                                | YEAR  | PISTON |        |   | SIZE  | PISTON BORE | RING SET |       |   | RING END GAP |
|--------------------------------------|-------|--------|--------|---|-------|-------------|----------|-------|---|--------------|
| <b>KAWASAKI CONTINUED</b>            |       |        |        |   |       |             |          |       |   |              |
| 1200 STX-12F<br>4 Stroke             | 03-07 | 328456 | 93.45  | L | Std.  | 83mm        | 328641   | 33.35 | L |              |
|                                      |       | 328454 | 93.45  | L | .25mm |             | 328642   | 33.35 | L |              |
|                                      |       | 328455 | 93.45  | L | .5mm  |             | 328643   | 33.35 | L |              |
| 1500 STX-15F<br>Ultra LX<br>4 Stroke | 04-15 | 328459 | 93.45  | L | Std.  | 83mm        | 328641   | 33.35 | L |              |
|                                      | 07-15 | 328457 | 93.45  | L | .25mm |             | 328642   | 33.35 | L |              |
|                                      |       | 328458 | 93.45  | L | .5mm  |             | 328643   | 33.35 | L |              |
| <b>Platinum Series</b>               |       |        |        |   |       |             |          |       |   |              |
| 1500 Ultra 250 X                     | 07-08 | 329116 | 99.95  | B | Std.  |             | 328641   | 33.35 | L |              |
| <b>Platinum Series</b>               |       |        |        |   |       |             |          |       |   |              |
| 1500 Ultra 260 X / LX                | 09-10 | 329117 | 99.95  | B | Std.  |             | 328641   | 33.35 | L |              |
| <b>Platinum Series</b>               |       |        |        |   |       |             |          |       |   |              |
| 1500 Ultra 300 X/LX                  | 11-13 | 329118 | 107.95 | B | Std.  |             | 328641   | 33.35 | L |              |
| <b>POLARIS</b>                       |       |        |        |   |       |             |          |       |   |              |
| 650                                  | All   | 328300 | 84.85  | L | Std.  | 65mm        | 328601   | 20.15 | L | .008-.018    |
|                                      |       | 328291 | 84.85  | L | .25mm |             | 328602   | 20.15 | L |              |
|                                      |       | 328292 | 84.85  | L | .5mm  |             | 328603   | 20.15 | L |              |
|                                      |       | 328293 | 84.85  | L | .75mm |             | 328604   | 20.15 | L |              |
|                                      |       | 328294 | 84.85  | L | 1mm   |             | 328605   | 20.15 | L |              |
| 700                                  | All   | 328329 | 84.85  | L | Std.  | 81mm        | 328606   | 35.00 | L | .010-.022    |
|                                      |       | 328301 | 84.85  | L | .25mm |             | 328607   | 35.00 | L |              |
|                                      |       | 328303 | 84.85  | L | .5mm  |             | 328608   | 35.00 | L |              |
|                                      |       | 328305 | 84.85  | L | .75mm |             | 328609   | 35.00 | L |              |
|                                      |       | 328307 | 84.85  | L | 1mm   |             | 328610   | 35.00 | L |              |
| <b>Platinum Series</b>               |       |        |        |   |       |             |          |       |   |              |
| 700                                  | All   | 328330 | 89.45  | L | Std.  | 81mm        | 328606   | 35.00 | L | .010-.022    |
|                                      |       | 328302 | 89.45  | L | .25mm |             | 328607   | 35.00 | L |              |
|                                      |       | 328304 | 89.45  | L | .5mm  |             | 328608   | 35.00 | L |              |
|                                      |       | 328306 | 84.85  | L | .75mm |             | 328609   | 35.00 | L |              |
|                                      |       | 328308 | 89.45  | L | 1mm   |             | 328610   | 35.00 | L |              |
| 750                                  | All   | 328290 | 84.85  | L | Std.  | 69.75mm     | 328596   | 24.50 | L | .008-.018    |
|                                      |       | 328281 | 84.85  | L | .25mm |             | 328597   | 24.50 | L |              |
|                                      |       | 328282 | 84.85  | L | .5mm  |             | 328598   | 24.50 | L |              |
|                                      |       | 328283 | 84.85  | L | .75mm |             | 328599   | 24.50 | L |              |
|                                      |       | 328284 | 84.85  | L | 1mm   |             | 328600   | 24.50 | L |              |
| 780                                  | All   | 328343 | 84.85  | L | Std.  | 71.3mm      | 328616   | 20.15 | L | .008-.018    |
|                                      |       | 328334 | 84.85  | L | .25mm |             | 328617   | 20.15 | L |              |
|                                      |       | 328335 | 84.85  | L | .5mm  |             | 328618   | 20.15 | L |              |
|                                      |       | 328336 | 84.85  | L | .75mm |             | 328619   | 20.15 | L |              |
|                                      |       | 328337 | 84.85  | L | 1mm   |             | 328620   | 20.15 | L |              |
| 800 Virage<br>Octane (777)           | 00-04 | 328372 | 84.85  | J | Std.  | 84mm        | 328621   | 31.50 | L | .010-.018    |
|                                      | 02-04 | 328344 | 84.85  | J | .25mm |             | 328622   | 31.50 | L |              |
|                                      |       | 328346 | 84.85  | J | .5mm  |             | 328623   | 31.50 | L |              |
|                                      |       | 328348 | 84.85  | J | .75mm |             | 328624   | 31.50 | L |              |
|                                      |       | 328350 | 84.85  | J | 1mm   |             | 328625   | 31.50 | L |              |
| <b>Platinum Series</b>               |       |        |        |   |       |             |          |       |   |              |
| 800 Virage<br>Octane (777)           | 00-04 | 328373 | 91.80  | L | Std.  | 84mm        | 328621   | 31.50 | L | .010-.018    |
|                                      | 02-04 | 328345 | 91.80  | L | .25mm |             | 328622   | 31.50 | L |              |
|                                      |       | 328347 | 91.80  | L | .5mm  |             | 328623   | 31.50 | L |              |
|                                      |       | 328349 | 91.80  | L | .75mm |             | 328624   | 31.50 | L |              |
|                                      |       | 328351 | 91.80  | L | 1mm   |             | 328625   | 31.50 | L |              |



## PWC ORIGINAL & PLATINUM PISTON KITS CONTINUED

| MODEL   | YEAR  | PISTON |       |   | SIZE  | PISTON BORE | RING SET |       |   | RING END GAP |
|---|-------|--------|-------|---|-------|-------------|----------|-------|---|--------------|
| <b>POLARIS CONTINUED</b>  |       |        |       |   |       |             |          |       |   |              |
| 900   | All   | N/L/A  |       |   | Std.  | 74.5mm      | 328611   | 20.15 | L | .010-.018    |
|   |       | N/L/A  |       |   | .25mm |             | 328612   | 20.15 | L |              |
|   |       | N/L/A  |       |   | .5mm  |             | 328613   | 20.15 | L |              |
|   |       | N/L/A  |       |   | .75mm |             | 328614   | 20.15 | L |              |
|   |       | N/L/A  |       |   | 1mm   |             | 328615   | 20.15 | L |              |
| 1050  | All   | 328329 | 84.85 | L | Std.  | 81mm        | 328606   | 35.00 | L | .010-.022    |
|   |       | 328301 | 84.85 | L | .25mm |             | 328607   | 35.00 | L |              |
|   |       | 328303 | 84.85 | L | .5mm  |             | 328608   | 35.00 | L |              |
|   |       | 328305 | 84.85 | L | .75mm |             | 328609   | 35.00 | L |              |
|   |       | 328307 | 84.85 | L | 1mm   |             | 328610   | 35.00 | L |              |
| <i>Platinum Series</i><br>1050  | All   | 328330 | 89.45 | L | Std.  | 81mm        | 328606   | 35.00 | L | .010-.022    |
|   |       | 328302 | 89.45 | L | .25mm |             | 328607   | 35.00 | L |              |
|   |       | 328304 | 89.45 | L | .5mm  |             | 328608   | 35.00 | L |              |
|   |       | 328306 | 84.85 | L | .75mm |             | 328609   | 35.00 | L |              |
|   |       | 328308 | 89.45 | L | 1mm   |             | 328610   | 35.00 | L |              |
| 1200 Genesis,<br>SLX, X-45,<br>Virage TX, TXi                           | 99-04 | 328372 | 84.85 | J | Std.  | 84mm        | 328621   | 31.50 | L | .010-.018    |
|   |       | 328344 | 84.85 | J | .25mm |             | 328622   | 31.50 | L |              |
|   |       | 328346 | 84.85 | J | .5mm  |             | 328623   | 31.50 | L |              |
|   |       | 328348 | 84.85 | J | .75mm |             | 328624   | 31.50 | L |              |
|   |       | 328350 | 84.85 | J | 1mm   |             | 328625   | 31.50 | L |              |
| <i>Platinum Series</i><br>1200 Genesis,<br>SLX, X-45,<br>Virage TX, TXi | 99-04 | 328373 | 91.80 | L | Std.  | 84mm        | 328621   | 31.50 | L | .010-.018    |
|   |       | 328345 | 91.80 | L | .25mm |             | 328622   | 31.50 | L |              |
|   |       | 328347 | 91.80 | L | .5mm  |             | 328623   | 31.50 | L |              |
|   |       | 328349 | 91.80 | L | .75mm |             | 328624   | 31.50 | L |              |
|   |       | 328351 | 91.80 | L | 1mm   |             | 328625   | 31.50 | L |              |
| <i>Platinum Series</i><br>1200 MSX140                                   | 03-04 | 328351 | 91.80 | L | Std.  | 85mm        | 328625   | 31.50 | L | .010-.018    |
| <b>SEA-DOO</b>  |       |        |       |   |       |             |          |       |   |              |
| 580   | All   | 327900 | 83.45 | L | Std.  | 76mm        | 328546   | 36.70 | L | .010-.039    |
|   |       | 327874 | 83.45 | L | .25mm |             | 328547   | 36.70 | L |              |
|   |       | 327876 | 83.45 | L | .5mm  |             | 328548   | 36.70 | L |              |
|   |       | 327878 | 83.45 | L | .75mm |             | 328549   | 36.70 | L |              |
|   |       | 327880 | 83.45 | L | 1mm   |             | 328550   | 36.70 | L |              |
| <i>Platinum Series</i><br>580   | All   | 327901 | 91.20 | L | Std.  | 76mm        | 328546   | 36.70 | L | .010-.039    |
|   |       | 327875 | 91.20 | L | .25mm |             | 328547   | 36.70 | L |              |
|   |       | 327877 | 91.20 | L | .5mm  |             | 328548   | 36.70 | L |              |
|   |       | 327879 | 91.20 | L | .75mm |             | 328549   | 36.70 | L |              |
|   |       | 327881 | 91.20 | L | 1mm   |             | 328550   | 36.70 | L |              |
| 650   | All   | 327927 | 83.45 | L | Std.  | 78mm        | 328551   | 35.00 | L | .010-.039    |
|   |       | 327902 | 83.45 | L | .25mm |             | 328552   | 35.00 | L |              |
|   |       | 327904 | 83.45 | L | .5mm  |             | 328553   | 35.00 | L |              |
|   |       | 327906 | 83.45 | L | .75mm |             | 328554   | 35.00 | L |              |
|   |       | 327908 | 83.45 | L | 1mm   |             | 328555   | 35.00 | L |              |
| <i>Platinum Series</i><br>650   | All   | 327928 | 91.20 | L | Std.  | 78mm        | 328551   | 35.00 | L | .010-.039    |
|   |       | 327903 | 91.20 | L | .25mm |             | 328552   | 35.00 | L |              |
|   |       | 327905 | 91.20 | L | .5mm  |             | 328553   | 35.00 | L |              |
|   |       | 327907 | 91.20 | L | .75mm |             | 328554   | 35.00 | L |              |
|   |       | 327909 | 91.20 | L | 1mm   |             | 328555   | 35.00 | L |              |

- accessories
- towables
- body
- controls
- electrical
- driveline
- engine**
- fuel & intake
- chemicals
- tie downs
- tools
- towing & loading

# MARINE



## PWC ORIGINAL & PLATINUM PISTON KITS CONTINUED

| MODEL                            | YEAR  | PISTON |        |   | SIZE  | PISTON BORE | RING SET |       |   | RING END GAP |
|----------------------------------|-------|--------|--------|---|-------|-------------|----------|-------|---|--------------|
| <b>SEA-DOO CONTINUED</b>         |       |        |        |   |       |             |          |       |   |              |
| 720                              | All   | 327947 | 83.45  | L | Std.  | 82mm        | 328556   | 35.00 | L | .010-.039    |
|                                  |       | 327929 | 83.45  | L | .25mm |             | 328557   | 35.00 | L |              |
|                                  |       | 327931 | 83.45  | L | .5mm  |             | 328558   | 35.00 | L |              |
|                                  |       | 327933 | 83.45  | L | .75mm |             | 328559   | 35.00 | L |              |
|                                  |       | 327935 | 83.45  | L | 1mm   |             | 328560   | 35.00 | L |              |
| <b>Platinum Series</b>           |       |        |        |   |       |             |          |       |   |              |
| 720                              | All   | 327948 | 91.20  | L | Std.  | 82mm        | 328556   | 35.00 | L | .010-.039    |
|                                  |       | 327930 | 91.20  | L | .25mm |             | 328557   | 35.00 | L |              |
|                                  |       | 327932 | 91.20  | L | .5mm  |             | 328558   | 35.00 | L |              |
|                                  |       | 327934 | 91.20  | L | .75mm |             | 328559   | 35.00 | L |              |
|                                  |       | 327936 | 91.20  | L | 1mm   |             | 328560   | 35.00 | L |              |
| 800 Carb. & RFI                  | All   | 327967 | 83.45  | L | Std.  | 82mm        | 328556   | 35.00 | L | .010-.039    |
|                                  |       | 327949 | 83.45  | L | .25mm |             | 328557   | 35.00 | L |              |
|                                  |       | 327951 | 83.45  | L | .5mm  |             | 328558   | 35.00 | L |              |
|                                  |       | 327953 | 83.45  | L | .75mm |             | 328559   | 35.00 | L |              |
|                                  |       | 327955 | 83.25  | L | 1mm   |             | 328560   | 35.00 | L |              |
| <b>Platinum Series</b>           |       |        |        |   |       |             |          |       |   |              |
| 800 Carb. & RFI                  | All   | 327968 | 91.20  | L | Std.  | 82mm        | 328556   | 35.00 | L | .010-.039    |
|                                  |       | 327950 | 91.20  | L | .25mm |             | 328557   | 35.00 | L |              |
|                                  |       | 327952 | 91.20  | L | .5mm  |             | 328558   | 35.00 | L |              |
|                                  |       | 327954 | 91.20  | L | .75mm |             | 328559   | 35.00 | L |              |
|                                  |       | 327956 | 91.20  | L | 1mm   |             | 328560   | 35.00 | L |              |
| <b>Platinum Series</b>           |       |        |        |   |       |             |          |       |   |              |
| 900 Spark                        |       | 329573 | 133.58 | L | Std.  | 74mm        | 329578   | 39.95 | L | TBA          |
|                                  |       | 329574 | 133.58 | L | .25mm |             | 329579   | 39.95 | L |              |
|                                  |       | 329575 | 133.58 | L | .5mm  |             | 329580   | 39.95 | L |              |
|                                  |       | 329576 | 133.58 | L | .75mm |             | 329581   | 39.95 | L |              |
|                                  |       | 329577 | 133.58 | L | 1mm   |             | 329582   | 39.95 | L |              |
| 951 Carb. Motors                 |       | 327987 | 94.70  | L | Std.  | 87.91mm     | 328561   | 35.00 | L | .010-.039    |
|                                  |       | 327969 | 94.70  | L | .25mm |             | 328562   | 35.00 | L |              |
|                                  |       | 327971 | 94.70  | L | .5mm  |             | 328563   | 35.00 | L |              |
|                                  |       | 327973 | 94.70  | L | .75mm |             | 328564   | 35.00 | L |              |
|                                  |       | 327975 | 94.70  | L | 1mm   |             | 328565   | 35.00 | L |              |
| <b>Platinum Series</b>           |       |        |        |   |       |             |          |       |   |              |
| 951 Carb. Motors                 |       | 327988 | 99.95  | L | Std.  | 87.91mm     | 328561   | 35.00 | L | .010-.039    |
|                                  |       | 327970 | 99.95  | L | .25mm |             | 328562   | 35.00 | L |              |
|                                  |       | 327972 | 99.95  | L | .5mm  |             | 328563   | 35.00 | L |              |
|                                  |       | 327974 | 99.95  | L | .75mm |             | 328564   | 35.00 | L |              |
|                                  |       | 327976 | 99.95  | L | 1mm   |             | 328565   | 35.00 | L |              |
| 951 DI                           |       | 327844 | 94.70  | L | Std.  | 87.91mm     | 328523   | 35.00 | L | .010-.039    |
|                                  |       | 327826 | 94.70  | L | .25mm |             | 328524   | 35.00 | L |              |
|                                  |       | 327828 | 94.70  | L | .5mm  |             | 328525   | 35.00 | L |              |
|                                  |       | 327830 | 94.70  | L | .75mm |             | 328526   | 35.00 | L |              |
|                                  |       | 327832 | 94.70  | L | 1mm   |             | 328527   | 35.00 | L |              |
| <b>Platinum Series</b>           |       |        |        |   |       |             |          |       |   |              |
| 951 DI                           |       | 327845 | 101.65 | L | Std.  | 87.91mm     | 328523   | 35.00 | L | .010-.039    |
|                                  |       | 327827 | 101.65 | L | .25mm |             | 328524   | 35.00 | L |              |
|                                  |       | 327829 | 101.65 | L | .5mm  |             | 328525   | 35.00 | L |              |
|                                  |       | 327831 | 101.65 | L | .75mm |             | 328526   | 35.00 | L |              |
|                                  |       | 327833 | 101.65 | L | 1mm   |             | 328527   | 35.00 | L |              |
| <b>Platinum Series</b>           |       |        |        |   |       |             |          |       |   |              |
| GTX 4 Tec & wake-board           | 03-07 | 328500 | 115.65 | L | Std.  | 99.96mm     | 328664   | 50.05 | L | 1.5          |
| GTI<br>Non Supercharged<br>155HP | 06-07 | 328499 | 115.65 | L | .5mm  |             | 328665   | 50.05 | L |              |

accessories  
towables  
body  
controls  
electrical  
driveline  
engine  
fuel & intake  
chemicals  
tie downs  
tools  
towing & loading

MARINE



## PWC ORIGINAL & PLATINUM PISTON KITS CONTINUED

| MODEL   | YEAR  | PISTON |        |   | SIZE  | PISTON BORE | RING SET |       |   | RING END GAP |
|---|-------|--------|--------|---|-------|-------------|----------|-------|---|--------------|
| <b>SEA-DOO CONTINUED</b>                              |       |        |        |   |       |             |          |       |   |              |
| <i>Platinum Series</i>                                |       |        |        |   |       |             |          |       |   |              |
| GTX 4 Tec   | 05-06 | 328502 | 115.65 | L | Std.  | 99.96mm     | 328664   | 50.05 | L | 1.5          |
| Super Charged   |       | 328501 | 115.65 | L | .5mm  |             | 328665   | 50.05 | L |              |
| Super Charged 185HP                                   |       |        |        |   |       |             |          |       |   |              |
| GTX 4 Tec Ltd.  | 05-14 | 328504 | 183.65 | L | Std.  | 99.96mm     | 328664   | 50.05 | L | 1.5          |
| RXP   | 05-13 | 328503 | 183.65 | L | .5mm  |             | 328665   | 50.05 | L |              |
| RXT   | 05-14 | 329120 | 183.95 | B | 1mm   |             | 329121   | 49.95 | B |              |
| Super Charged<br>215 / 255/260<br>Forged / Platinum   |       |        |        |   |       |             |          |       |   |              |
| <b>TIGER SHARK</b>                                    |       |        |        |   |       |             |          |       |   |              |
| 640   | 93-99 | 328469 | 86.80  | L | Std.  | 75.7mm      | 328644   | 20.15 | L | .010-.039    |
|   |       | 328460 | 86.80  | L | .25mm |             | 328645   | 20.15 | L |              |
|   |       | 328461 | 86.80  | L | .5mm  |             | 328646   | 20.15 | L |              |
|   |       | 328462 | 86.80  | L | .75mm |             | 328647   | 20.15 | L |              |
|   |       | 328463 | 86.80  | L | 1mm   |             | 328648   | 20.15 | L |              |
| 770   | 96-99 | 328479 | 86.80  | L | Std.  | 83mm        | 328649   | 20.15 | L | .010-.039    |
|   |       | 328470 | 86.80  | L | .25mm |             | 328650   | 20.15 | L |              |
|   |       | 328471 | 86.80  | L | .5mm  |             | 328651   | 20.15 | L |              |
|   |       | 328472 | 86.80  | L | .75mm |             | 328652   | 20.15 | L |              |
|   |       | 328473 | 86.80  | L | 1mm   |             | 328653   | 20.15 | L |              |
| 900   | 95-98 | N/L/A  |        |   | Std.  | 76.5mm      | 328654   | 20.15 | L | .010-.039    |
|   |       | 328480 | 86.80  | L | .25mm |             | 328655   | 20.15 | L |              |
|   |       | 328481 | 86.80  | L | .5mm  |             | 328656   | 20.15 | L |              |
|   |       | 328482 | 86.80  | L | .75mm |             | 328657   | 20.15 | L |              |
|   |       | 328483 | 86.80  | L | 1mm   |             | 328658   | 20.15 | L |              |
| 1000  | 97-00 | 328498 | 86.80  | L | Std.  | 81mm        | 328659   | 20.15 | L | .010-.039    |
|   |       | 328489 | 86.80  | L | .25mm |             | 328660   | 20.15 | L |              |
|   |       | 328490 | 86.80  | L | .5mm  |             | 328661   | 20.15 | L |              |
|   |       | 328491 | 86.80  | L | .75mm |             | 328662   | 20.15 | L |              |
|   |       | 328492 | 86.80  | L | 1mm   |             | 328663   | 20.15 | L |              |
| <b>YAMAHA</b>   |       |        |        |   |       |             |          |       |   |              |
| 500   | 87-93 | 327795 | 75.10  | L | Std.  | 72mm        | -        |       |   | .008-.014    |
|   |       | 327786 | 75.10  | L | .25mm |             | 328514   | 17.20 | L |              |
|   |       | 327787 | 75.10  | L | .5mm  |             | 328515   | 17.20 | L |              |
|   |       | 327788 | 75.10  | L | .75mm |             | 328516   | 17.20 | L |              |
|   |       | 327789 | 75.10  | L | 1mm   |             | 328517   | 17.20 | L |              |
| 650   | All   | 327805 | 70.10  | L | Std.  | 77mm        | 328518   | 20.15 | L | .008-.016    |
|   |       | 327796 | 70.10  | L | .25mm |             | 328519   | 20.15 | L |              |
|   |       | 327797 | 70.10  | L | .5mm  |             | 328520   | 20.15 | L |              |
|   |       | 327798 | 70.10  | L | .75mm |             | 328521   | 20.15 | L |              |
|   |       | 327799 | 70.10  | L | 1mm   |             | 328522   | 20.15 | L |              |
| 701 (61X)<br>no window Port                           | All   | 328192 | 75.10  | L | Std.  | 81mm        | 328576   | 20.15 | L | .008-.016    |
|   |       | 328174 | 75.10  | L | .25mm |             | 328577   | 20.15 | L |              |
|   |       | 328176 | 75.10  | L | .5mm  |             | 328578   | 20.15 | L |              |
|   |       | 328178 | 75.10  | L | .75mm |             | 328579   | 20.15 | L |              |
|   |       | 328180 | 75.10  | L | 1mm   |             | 328580   | 20.15 | L |              |
| <i>Platinum Series</i><br>701 (61X)<br>no window Port | All   | 328193 | 83.45  | L | Std.  | 81mm        | 328576   | 20.15 | L | .008-.016    |
|   |       | 328175 | 83.45  | L | .25mm |             | 328577   | 20.15 | L |              |
|   |       | 328177 | 83.45  | L | .5mm  |             | 328578   | 20.15 | L |              |
|   |       | 328179 | 83.45  | L | .75mm |             | 328579   | 20.15 | L |              |
|   |       | 328181 | 83.45  | L | 1mm   |             | 328580   | 20.15 | L |              |

- accessories
- towables
- body
- controls
- electrical
- driveline
- engine**
- fuel & intake
- chemicals
- tie downs
- tools
- towing & loading

# MARINE



- accessories
- towables
- body
- controls
- electrical
- driveline
- engine
- fuel & intake
- chemicals
- tie downs
- tools
- towing & loading

| MODEL   | YEAR              | PISTON |       |   | SIZE  | PISTON BORE | RING SET |       |   | RING END GAP   |
|---|-------------------|--------|-------|---|-------|-------------|----------|-------|---|--|
| <b>YAMAHA CONTINUED</b>   |                   |        |       |   |       |             |          |       |   |  |
| 701 (62T)<br>with window port                                       | All               | 328252 | 75.10 | L | Std.  | 81mm        | 328576   | 20.15 | L | .008-.016  |
|   |                   | 328224 | 75.10 | L | .25mm |             | 328577   | 20.15 | L |  |
|   |                   | 328226 | 75.10 | L | .5mm  |             | 328578   | 20.15 | L |  |
|   |                   | 328228 | 75.10 | L | .75mm |             | 328579   | 20.15 | L |  |
|   |                   | 328230 | 75.10 | L | 1mm   |             | 328580   | 20.15 | L |  |
| <i>Platinum Series</i><br>701 (62T)<br>with window port             |                   | 328253 | 83.45 | L | Std.  | 81mm        | 328576   | 20.15 | L | .008-.016  |
|   |                   | 328225 | 83.45 | L | .25mm |             | 328577   | 20.15 | L |  |
|   |                   | 328227 | 83.45 | L | .5mm  |             | 328578   | 20.15 | L |  |
|   |                   | 328229 | 83.45 | L | .75mm |             | 328579   | 20.15 | L |  |
|   |                   | 328231 | 83.45 | L | 1mm   |             | 328580   | 20.15 | L |  |
| 760   | All               | 328222 | 80.10 | L | Std.  | 84mm        | 328581   | 20.15 | L | .008-.016  |
|   |                   | 328194 | 80.10 | L | .25mm |             | 328582   | 20.15 | L |  |
|   |                   | 328196 | 80.10 | L | .5mm  |             | 328583   | 20.15 | L |  |
|   |                   | 328198 | 80.10 | L | .75mm |             | 328584   | 20.15 | L |  |
|   |                   | 328200 | 80.10 | L | 1mm   |             | 328585   | 20.15 | L |  |
| <i>Platinum Series</i><br>760                                       | All               | 328223 | 86.80 | L | Std.  | 84mm        | 328581   | 20.15 | L | .008-.016  |
|   |                   | 328195 | 86.80 | L | .25mm |             | 328582   | 20.15 | L |  |
|   |                   | 328197 | 86.80 | L | .5mm  |             | 328583   | 20.15 | L |  |
|   |                   | 328199 | 86.80 | L | .75mm |             | 328584   | 20.15 | L |  |
|   |                   | 328201 | 86.80 | L | 1mm   |             | 328585   | 20.15 | L |  |
| <i>Platinum Series</i><br>800<br>Power Valve motor                  | All               | 328280 | 86.80 | L | Std.  | 79.90mm     | 328591   | 29.75 | L | .008-.016<br>Replacement Ring<br>for 328280<br>O.E. no.<br>66V-11603-00-00 |
|   |                   | 328265 | 86.80 | L | .25mm |             | 328592   | 29.75 | L |  |
|   |                   | 328266 | 86.80 | L | .5mm  |             | 328593   | 29.75 | L |  |
|   |                   | 328267 | 86.80 | L | .75mm |             | 328594   | 29.75 | L |  |
|   |                   | 328268 | 86.80 | L | 1mm   |             | 328595   | 29.75 | L |  |
| 1100 2 Stroke   |                   | 328252 | 75.10 | L | Std.  | 81mm        | 328576   | 20.15 | L | .008-.016  |
|   |                   | 328224 | 75.10 | L | .25mm |             | 328577   | 20.15 | L |  |
|   |                   | 328226 | 75.10 | L | .5mm  |             | 328578   | 20.15 | L |  |
|   |                   | 328228 | 75.10 | L | .75mm |             | 328579   | 20.15 | L |  |
|   |                   | 328230 | 75.10 | L | 1mm   |             | 328580   | 20.15 | L |  |
| <i>Platinum Series</i><br>1100 2 Stroke                             |                   | 328253 | 83.45 | L | Std.  | 81mm        | 328576   | 20.15 | L | .008-.016  |
|   |                   | 328225 | 83.45 | L | .25mm |             | 328577   | 20.15 | L |  |
|   |                   | 328227 | 83.45 | L | .5mm  |             | 328578   | 20.15 | L |  |
|   |                   | 328229 | 83.45 | L | .75mm |             | 328579   | 20.15 | L |  |
|   |                   | 328231 | 83.45 | L | 1mm   |             | 328580   | 20.15 | L |  |
| 1200 (no power valves)<br>GP<br>XL<br>SUV                           | 97-99<br>98<br>99 | 328222 | 80.10 | L | Std.  | 84mm        | 328581   | 20.15 | L | .008-.016  |
|   |                   | 328194 | 80.10 | L | .25mm |             | 328582   | 20.15 | L |  |
|   |                   | 328196 | 80.10 | L | .5mm  |             | 328583   | 20.15 | L |  |
|   |                   | 328198 | 80.10 | L | .75mm |             | 328584   | 20.15 | L |  |
|   |                   | 328200 | 80.10 | L | 1mm   |             | 328585   | 20.15 | L |  |
| <i>Platinum Series</i><br>1200 (no power valves)<br>GP<br>XL<br>SUV | 97-99<br>98<br>99 | 328223 | 86.80 | L | Std.  | 84mm        | 328581   | 20.15 | L | .008-.016  |
|   |                   | 328195 | 86.80 | L | .25mm |             | 328582   | 20.15 | L |  |
|   |                   | 328197 | 86.80 | L | .5mm  |             | 328583   | 20.15 | L |  |
|   |                   | 328199 | 86.80 | L | .75mm |             | 328584   | 20.15 | L |  |
|   |                   | 328201 | 86.80 | L | 1mm   |             | 328585   | 20.15 | L |  |





## PWC ORIGINAL & PLATINUM PISTON KITS CONTINUED

| MODEL  | YEAR  | PISTON        |               |   | SIZE  | PISTON BORE | RING SET      |              |   | RING END GAP |
|--|-------|---------------|---------------|---|-------|-------------|---------------|--------------|---|--------------|
| <b>YAMAHA CONTINUED</b>  |       |               |               |   |       |             |               |              |   |              |
| <b>Platinum Series</b>   |       |               |               |   |       |             |               |              |   |              |
| 1200 (power valves)  |       | <b>328280</b> | <b>86.80</b>  | L | Std.  | 79.90mm     | <b>328591</b> | <b>29.75</b> | L | .008-.016    |
| GP   | 00-02 | <b>328265</b> | <b>86.80</b>  | L | .25mm |             | <b>328592</b> | <b>29.75</b> | L |              |
| XL   | 99-01 | <b>328266</b> | <b>86.80</b>  | L | .5mm  |             | <b>328593</b> | <b>29.75</b> | L |              |
| XLT  | 02-05 | <b>328267</b> | <b>86.80</b>  | L | .75mm |             | <b>328594</b> | <b>29.75</b> | L |              |
|  |       | <b>328268</b> | <b>86.80</b>  | L | 1mm   |             | <b>328595</b> | <b>29.75</b> | L |              |
| <b>Platinum Series</b>   |       |               |               |   |       |             |               |              |   |              |
| 1300 GP  | 03-08 | <b>328173</b> | <b>100.15</b> | L | Std.  | 84mm        | <b>328571</b> | <b>28.40</b> | L |              |
|  |       | <b>328165</b> | <b>100.15</b> | L | .25mm |             | <b>328572</b> | <b>28.40</b> | L |              |
|  |       | <b>328166</b> | <b>100.15</b> | L | .5mm  |             | <b>328573</b> | <b>28.40</b> | L |              |
|  |       | <b>328167</b> | <b>100.15</b> | L | .75mm |             | <b>328574</b> | <b>28.40</b> | L |              |
|  |       | <b>329094</b> | <b>100.12</b> | L | 1mm   |             | <b>328575</b> | <b>28.40</b> | L |              |
| FX-140 4 Stroke<br>6BE-11631-00-BO   | 02-06 | <b>328507</b> | <b>80.10</b>  | L | Std.  | 73.9mm      | <b>328666</b> | <b>21.15</b> | L |              |
|  |       | <b>328505</b> | <b>100.15</b> | L | .25mm |             | <b>328667</b> | <b>33.32</b> | L |              |
|  |       | <b>328506</b> | <b>100.15</b> | L | .5mm  |             | <b>328668</b> | <b>33.32</b> | L |              |
| FX-140 4 Stroke<br>High Output<br>60E-11631-00-BO  | 04-08 | <b>328509</b> | <b>86.80</b>  | L | Std.  | 75.9mm      | <b>328669</b> | <b>30.00</b> | L |              |
|  |       | <b>328508</b> | <b>116.85</b> | L | .25mm |             | <b>328670</b> | <b>38.35</b> | L |              |
| VX 1100  | 05-15 | <b>328512</b> | <b>100.15</b> | L | Std.  | 75.9mm      | <b>328669</b> | <b>30.00</b> | L |              |
| V1 / V1 Sport<br>Nikosil bore<br>requires resleeving<br>6D3-11631-00-BO  | 15    | <b>328510</b> | <b>121.85</b> | L | .25mm |             | <b>328670</b> | <b>38.35</b> | L |              |
|  |       | <b>328511</b> | <b>121.85</b> | L | .5mm  |             | <b>328671</b> | <b>38.35</b> | L |              |
|  |       |               |               |   |       |             |               |              |   |              |
| <b>Platinum Series</b>   |       |               |               |   |       |             |               |              |   |              |
| FX Cruiser Super<br>High Output 1800<br>Supercharged Nikosil<br>Bore Requires<br>Resleeving<br>6S5-11631-10-BO | 08-12 | <b>329095</b> | <b>116.82</b> | L | Std.  | 85.9mm      | <b>329097</b> | <b>31.95</b> | L |              |
|  |       | <b>329122</b> | <b>116.95</b> | B | .25mm |             | <b>329098</b> | <b>31.95</b> | L |              |
|  |       | <b>329123</b> | <b>116.95</b> | B | .5mm  |             | <b>329099</b> | <b>31.95</b> | L |              |
|  |       | <b>329124</b> | <b>116.95</b> | B | .75mm |             | <b>329100</b> | <b>31.95</b> | L |              |
|  |       | <b>329125</b> | <b>116.95</b> | B | 1mm   |             | <b>329101</b> | <b>31.95</b> | L |              |
| <b>Platinum Series</b>   |       |               |               |   |       |             |               |              |   |              |
| FX Cruiser High<br>Output 1800<br>Non Supercharged<br>Nikosil Bore Requires<br>Resleeving<br>6BH-11631-00-BO   | 08-15 | <b>329096</b> | <b>116.92</b> | L | Std.  | 85.9mm      | <b>329097</b> | <b>31.95</b> | L |              |
|  |       | <b>329126</b> | <b>116.95</b> | B | .25mm |             | <b>329098</b> | <b>31.95</b> | L |              |
|  |       | <b>329127</b> | <b>116.95</b> | B | .5mm  |             | <b>329099</b> | <b>31.95</b> | L |              |
|  |       | <b>329128</b> | <b>116.95</b> | B | .75mm |             | <b>329100</b> | <b>31.95</b> | L |              |
|  |       | <b>329129</b> | <b>116.95</b> | B | 1mm   |             | <b>329101</b> | <b>31.95</b> | L |              |

- accessories
- towables
- body
- controls
- electrical
- driveline
- engine**
- fuel & intake
- chemicals
- tie downs
- tools
- towing & loading

# MARINE

# ENGINE

## PERSONAL WATERCRAFT ORIGINAL & PLATINUM SERIES TOP END REBUILD KITS



WSM High-quality complete top end rebuild kits include platinum series pistons, rings, wrist pins and circlips, along with head, base, intake (where applicable) and exhaust gaskets - enough for one engine.

Platinum pistons and rings are the same design as the originals for interchangeability.



- accessories
- towables
- body
- controls
- electrical
- driveline
- engine**
- fuel & intake
- chemicals
- tie downs
- tools
- towing & loading

MARINE

| MODEL                       | YEAR  | SIZE   | PART #        |               |   |
|-----------------------------|-------|--------|---------------|---------------|---|
| <b>KAWASAKI</b>             |       |        |               |               |   |
| 550 SX                      | 82-90 | Std.   | <b>327862</b> | <b>188.65</b> | L |
|                             |       | .25mm  | <b>327863</b> | <b>188.65</b> | L |
|                             |       | .5mm   | <b>327864</b> | <b>188.65</b> | L |
|                             |       | .75mm  | <b>327865</b> | <b>188.65</b> | L |
|                             |       | 1mm    | <b>327866</b> | <b>188.65</b> | L |
| 650 All                     | 91-96 | Std.   | <b>327850</b> | <b>203.35</b> | L |
|                             |       | 0.25mm | <b>327851</b> | <b>203.35</b> | L |
|                             |       | 0.50mm | <b>327852</b> | <b>203.35</b> | L |
|                             |       | 0.75mm | <b>327853</b> | <b>203.35</b> | L |
|                             |       | 1.00mm | <b>327854</b> | <b>203.35</b> | L |
| 750 SS                      | 92-95 | Std.   | <b>327997</b> | <b>212.40</b> | L |
| 750 SSXi                    | 93-95 | .25mm  | <b>327999</b> | <b>212.40</b> | L |
| 750 ST                      | 94-95 | .5mm   | <b>328127</b> | <b>212.40</b> | L |
| 750 SX                      | 92-94 | .75mm  | <b>328129</b> | <b>212.40</b> | L |
| 750 XiR, SXi                | 94    | 1mm    | <b>328131</b> | <b>212.40</b> | L |
| <b>Note: 20mm Wrist Pin</b> |       |        |               |               |   |
| <b>Platinum Series</b>      |       |        |               |               |   |
| 750 SS                      | 92-95 | Std.   | <b>327998</b> | <b>231.50</b> | L |
| 750 SSXi                    | 93-95 | .25mm  | <b>328126</b> | <b>231.50</b> | L |
| 750 ST                      | 94-95 | .5mm   | <b>328128</b> | <b>231.50</b> | L |
| 750 SX                      | 92-94 | .75mm  | <b>328130</b> | <b>231.50</b> | L |
| 750 XiR, SXi                | 94    | 1mm    | <b>328132</b> | <b>231.50</b> | L |
| <b>Note: 20mm Wrist Pin</b> |       |        |               |               |   |
| 750 SS, SSXi                | 96-97 | Std.   | <b>328143</b> | <b>235.70</b> | L |
| 750 STS                     | 95-97 | .25mm  | <b>328145</b> | <b>235.70</b> | L |
| 750 STX                     | 98    | .5mm   | <b>328147</b> | <b>235.70</b> | L |
| 750 SXi                     | 95-96 | .75mm  | <b>328149</b> | <b>235.70</b> | L |
| 750 ZXi                     | 95-97 | 1mm    | <b>328151</b> | <b>235.70</b> | L |
| <b>Note: 20mm Wrist Pin</b> |       |        |               |               |   |
| <b>Platinum Series</b>      |       |        |               |               |   |
| 750 SS, SSXi                | 96-97 | Std.   | <b>328144</b> | <b>249.10</b> | L |
| 750 STS                     | 95-97 | .25mm  | <b>328146</b> | <b>249.10</b> | L |
| 750 STX                     | 98    | .5mm   | <b>328148</b> | <b>249.10</b> | L |
| 750 SXi                     | 95-96 | .75mm  | <b>328150</b> | <b>249.10</b> | L |
| 750 ZXi                     | 95-97 | 1mm    | <b>328152</b> | <b>249.10</b> | L |
| <b>Note: 20mm Wrist Pin</b> |       |        |               |               |   |
| 800                         | All   | Std.   | <b>328442</b> | <b>262.95</b> | L |
|                             |       | .25mm  | <b>328444</b> | <b>262.95</b> | L |
|                             |       | .5mm   | <b>328446</b> | <b>262.95</b> | L |
|                             |       | .75mm  | <b>328448</b> | <b>262.95</b> | L |
|                             |       | 1mm    | <b>328450</b> | <b>262.95</b> | L |
| <b>Platinum Series</b>      |       |        |               |               |   |
| 800                         | All   | Std.   | <b>328443</b> | <b>268.20</b> | L |
|                             |       | .25mm  | <b>328445</b> | <b>268.20</b> | L |
|                             |       | .5mm   | <b>328447</b> | <b>268.20</b> | L |
|                             |       | .75mm  | <b>328449</b> | <b>268.20</b> | L |
|                             |       | 1mm    | <b>328451</b> | <b>268.20</b> | L |

| MODEL                     | YEAR          | SIZE                  | PART #        |               |               |               |   |
|---------------------------|---------------|-----------------------|---------------|---------------|---------------|---------------|---|
| <b>KAWASAKI CONTINUED</b> |               |                       |               |               |               |               |   |
| 900<br>except STX 97-06   | All           | Std.                  | <b>328382</b> | <b>329.95</b> | L             |               |   |
|                           |               | .25mm                 | <b>328384</b> | <b>329.95</b> | L             |               |   |
|                           |               | .5mm                  | <b>328386</b> | <b>329.95</b> | L             |               |   |
|                           |               | .75mm                 | <b>328388</b> | <b>329.95</b> | L             |               |   |
|                           |               | 1mm                   | <b>328390</b> | <b>329.95</b> | L             |               |   |
| <b>Platinum Series</b>    |               |                       |               |               |               |               |   |
| 900<br>except STX 97-06   | All           | Std.                  | <b>328383</b> | <b>349.95</b> | L             |               |   |
|                           |               | .25mm                 | <b>328385</b> | <b>349.95</b> | L             |               |   |
|                           |               | .5mm                  | <b>328387</b> | <b>381.70</b> | L             |               |   |
|                           |               | .75mm                 | <b>328389</b> | <b>349.95</b> | L             |               |   |
|                           |               | 1mm                   | <b>328391</b> | <b>349.95</b> | L             |               |   |
| 900 STX                   | 97-98         | Std.                  | <b>329583</b> | <b>371.71</b> | L             |               |   |
|                           |               | .25mm                 | <b>329584</b> | <b>371.71</b> | L             |               |   |
|                           |               | .5mm                  | <b>329585</b> | <b>371.71</b> | L             |               |   |
|                           |               | .75mm                 | <b>329586</b> | <b>371.71</b> | L             |               |   |
|                           |               | 1mm                   | <b>329587</b> | <b>371.71</b> | L             |               |   |
| <b>Platinum Series</b>    |               |                       |               |               |               |               |   |
| 900 STX                   | 97-98         | Std.                  | <b>329588</b> | <b>381.68</b> | L             |               |   |
|                           |               | .25mm                 | <b>329589</b> | <b>381.68</b> | L             |               |   |
|                           |               | .5mm                  | <b>329590</b> | <b>381.68</b> | L             |               |   |
|                           |               | .75mm                 | <b>329591</b> | <b>381.68</b> | L             |               |   |
|                           |               | 1mm                   | <b>329592</b> | <b>381.68</b> | L             |               |   |
| 1100 STX                  | 97-99         | Std.                  | <b>328153</b> | <b>375.00</b> | L             |               |   |
| 1100 ZXi                  | 96-03         | .25mm                 | <b>328155</b> | <b>375.00</b> | L             |               |   |
|                           |               | .5mm                  | <b>328157</b> | <b>375.00</b> | L             |               |   |
|                           |               | .75mm                 | <b>328159</b> | <b>375.00</b> | L             |               |   |
|                           |               | 1mm                   | <b>328161</b> | <b>375.00</b> | L             |               |   |
| <b>Platinum Series</b>    |               |                       |               |               |               |               |   |
| 1100 STX                  | 97-99         | Std.                  | <b>328154</b> | <b>395.05</b> | L             |               |   |
|                           |               | .25mm                 | <b>328156</b> | <b>395.05</b> | L             |               |   |
|                           |               | .5mm                  | <b>328158</b> | <b>395.05</b> | L             |               |   |
|                           |               | .75mm                 | <b>328160</b> | <b>395.05</b> | L             |               |   |
| 1100 ZXi                  | 96-03         | 1mm                   | <b>328162</b> | <b>395.05</b> | L             |               |   |
|                           |               | 1100 STX Di           | 00-03         | Std.          | <b>328422</b> | <b>385.70</b> | L |
|                           |               | 1100 Ultra-<br>130 Di | 01-04         | .25mm         | <b>328424</b> | <b>385.70</b> | L |
|                           |               |                       |               | .5mm          | <b>328426</b> | <b>385.70</b> | L |
| .75mm                     | <b>328428</b> |                       |               | <b>385.70</b> | L             |               |   |
|                           |               | 1mm                   | <b>328430</b> | <b>385.70</b> | L             |               |   |
| <b>Platinum Series</b>    |               |                       |               |               |               |               |   |
| 1100 STX Di               | 00-03         | Std.                  | <b>328423</b> | <b>403.25</b> | L             |               |   |
|                           |               | .25mm                 | <b>328425</b> | <b>403.25</b> | L             |               |   |
|                           |               | 1100 Ultra-<br>130 Di | 01-04         | .5mm          | <b>328427</b> | <b>403.25</b> | L |
|                           |               |                       |               | .75mm         | <b>328429</b> | <b>403.25</b> | L |
|                           |               | 1mm                   | <b>328431</b> | <b>403.25</b> | L             |               |   |

## PWC ORIGINAL & PLATINUM TOP END REBUILD KITS CONTINUED

| MODEL                     | YEAR  | SIZE  | PART # |        |   |
|---------------------------|-------|-------|--------|--------|---|
| <b>KAWASAKI CONTINUED</b> |       |       |        |        |   |
| 1200 Ultra 150            | 99-05 | Std.  | 328402 | 413.30 | L |
| 1200 STX-R                | 02-05 | .25mm | 328404 | 413.30 | L |
|                           |       | .5mm  | 328406 | 413.30 | L |
|                           |       | .75mm | 328408 | 413.30 | L |
|                           |       | 1mm   | 328410 | 413.30 | L |
| <b>Platinum Series</b>    |       |       |        |        |   |
| 1200 Ultra 150            | 99-05 | Std.  | 328403 | 443.55 | L |
| 1200 STX-R                | 02-05 | .25mm | 328405 | 443.55 | L |
|                           |       | .5mm  | 328407 | 443.55 | L |
|                           |       | .75mm | 328409 | 443.55 | L |
|                           |       | 1mm   | 328411 | 443.55 | L |
| STX-12F                   | 03-07 | Std.  | 329130 | 592.77 | L |
|                           |       | .25mm | 329131 | 592.77 | L |
|                           |       | .50mm | 329132 | 592.77 | L |
| STX-15F                   | 04-15 | Std.  | 329133 | 592.77 | L |
|                           |       | .25mm | 329134 | 592.77 | L |
|                           |       | .50mm | 329135 | 592.77 | L |
| <b>Platinum Series</b>    |       |       |        |        |   |
| Ultra 250X                | 07-08 | Std.  | 329473 | 659.91 | J |
| <b>Platinum Series</b>    |       |       |        |        |   |
| Ultra 260                 | 09-10 | Std.  | 329474 | 659.91 | J |
| <b>Platinum Series</b>    |       |       |        |        |   |
| Ultra 300                 | 11-13 | Std.  | 329475 | 659.91 | J |
| <b>POLARIS</b>            |       |       |        |        |   |
| 650                       | All   | Std.  | 328295 | 249.95 | L |
|                           |       | .25mm | 328296 | 249.95 | L |
|                           |       | .5mm  | 328297 | 249.95 | L |
|                           |       | .75mm | 328298 | 249.95 | L |
|                           |       | 1mm   | 328299 | 249.95 | L |
| 700                       | All   | Std.  | 328309 | 201.60 | L |
|                           |       | .25mm | 328311 | 201.60 | L |
|                           |       | .5mm  | 328313 | 201.60 | L |
|                           |       | .75mm | 328315 | 201.60 | L |
|                           |       | 1mm   | 328317 | 201.60 | L |
| <b>Platinum Series</b>    |       |       |        |        |   |
| 700                       | All   | Std.  | 328310 | 219.10 | L |
|                           |       | .25mm | 328312 | 219.10 | L |
|                           |       | .5mm  | 328314 | 219.10 | L |
|                           |       | .75mm | 328316 | 219.10 | L |
|                           |       | 1mm   | 328318 | 219.10 | L |
| 750                       | All   | Std.  | 328285 | 333.10 | L |
|                           |       | .25mm | 328286 | 333.10 | L |
|                           |       | .5mm  | 328287 | 333.10 | L |
|                           |       | .75mm | 328288 | 333.10 | L |
|                           |       | 1mm   | 328289 | 333.10 | L |
| 780                       | All   | Std.  | 328338 | 333.10 | L |
|                           |       | .25mm | 328339 | 333.10 | L |
|                           |       | .5mm  | 328340 | 333.10 | L |
|                           |       | .75mm | 328341 | 333.10 | L |
|                           |       | 1mm   | 328342 | 333.10 | L |
| 800 Virage<br>-777        | All   | Std.  | 328352 | 227.90 | L |
|                           |       | .25mm | 328354 | 227.90 | L |
|                           |       | .5mm  | 328356 | 227.90 | L |
|                           |       | .75mm | 328358 | 227.90 | L |
|                           |       | 1mm   | 328360 | 227.90 | L |

| MODEL   | YEAR    | SIZE  | PART # |        |   |
|---|---------|-------|--------|--------|---|
| <b>POLARIS CONTINUED</b>                            |         |       |        |        |   |
| <b>Platinum Series</b>                              |         |       |        |        |   |
| 800 Virage -<br>777                                 | All     | Std.  | 328353 | 245.45 | L |
|   |         | .25mm | 328355 | 245.45 | L |
|   |         | .50mm | 328357 | 245.45 | L |
|   |         | .75mm | 328359 | 245.45 | L |
|   |         | 1mm   | 328361 | 245.45 | L |
| 1050  | All     | Std.  | 328319 | 282.25 | L |
|   |         | .25mm | 328321 | 282.25 | L |
|   |         | .5mm  | 328323 | 282.25 | L |
|   |         | .75mm | 328325 | 282.25 | L |
|   |         | 1mm   | 328327 | 282.25 | L |
| <b>Platinum Series</b>                              |         |       |        |        |   |
| 1050  | All     | Std.  | 328320 | 301.55 | L |
|   |         | .25mm | 328322 | 301.55 | L |
|   |         | .5mm  | 328324 | 301.55 | L |
|   |         | .75mm | 328326 | 301.55 | L |
|   |         | 1mm   | 328328 | 301.55 | L |
| 1200<br>Genesis,<br>SLX, X-45,<br>Virage TX,<br>TXi | 99-04   | Std.  | 328362 | 317.25 | L |
|   |         | .25mm | 328364 | 317.25 | L |
|   |         | .5mm  | 328366 | 317.25 | L |
|   |         | .75mm | 328368 | 317.25 | L |
| <b>Platinum Series</b>                              |         |       |        |        |   |
| 1200<br>Genesis,<br>SLX, X-45,<br>Virage TX,<br>TXi | 99-04   | Std.  | 328363 | 340.60 | L |
|   |         | .25mm | 328365 | 340.60 | L |
|   |         | .5mm  | 328367 | 340.60 | L |
|   |         | .75mm | 328369 | 340.60 | L |
| <b>SEA-DOO</b>                                      |         |       |        |        |   |
| 580 (yellow)  | 88-91   | Std.  | 327892 | 189.95 | L |
|   |         | .25mm | 327894 | 227.90 | L |
|   |         | .5mm  | 327896 | 227.90 | L |
|   |         | .75mm | 327897 | 227.90 | L |
|   |         | 1mm   | 327899 | 199.95 | L |
| 580 (white)   | 92 & up | Std.  | 327882 | 229.90 | L |
|   |         | .25mm | 327884 | 229.90 | L |
|   |         | .5mm  | 327886 | 229.90 | L |
|   |         | .75mm | 327888 | 229.90 | L |
|   |         | 1mm   | 327890 | 229.90 | L |
| <b>Platinum Series</b>                              |         |       |        |        |   |
| 580 (white)   | 92 & up | Std.  | 327883 | 245.45 | L |
|   |         | .25mm | 327885 | 245.45 | L |
|   |         | .5mm  | 327887 | 245.45 | L |
|   |         | .75mm | 327889 | 245.45 | L |
|   |         | 1mm   | 327891 | 245.45 | L |
| 650   | 93      | Std.  | 327920 | 229.90 | L |
|   |         | .25mm | 327922 | 227.90 | L |
|   |         | .5mm  | 327923 | 227.90 | L |
|   |         | .75mm | 327924 | 227.90 | L |
|   |         | 1mm   | 327926 | 227.90 | L |
| 650   | 94 & up | Std.  | 327910 | 229.90 | L |
|   |         | .25mm | 327912 | 229.90 | L |
|   |         | .5mm  | 327914 | 229.90 | L |
|   |         | .75mm | 327916 | 229.90 | L |
|   |         | 1mm   | 327918 | 229.90 | L |

accessories

towables

body

controls

electrical

driveline

engine

fuel &  
intake

chemicals

tie downs

tools

towing &  
loading

# MARINE

## PWC ORIGINAL & PLATINUM TOP END REBUILD KITS CONTINUED

- accessories
- towables
- body
- controls
- electrical
- driveline
- engine**
- fuel & intake
- chemicals
- tie downs
- tools
- towing & loading

MARINE

| MODEL                    | YEAR    | SIZE  | PART # |        |   |
|--------------------------|---------|-------|--------|--------|---|
| <b>SEA-DOO CONTINUED</b> |         |       |        |        |   |
| <i>Platinum Series</i>   |         |       |        |        |   |
| 650                      | 94 & up | Std.  | 327911 | 245.45 | L |
|                          |         | .25mm | 327913 | 245.45 | L |
|                          |         | .5mm  | 327915 | 245.45 | L |
|                          |         | .75mm | 327917 | 245.45 | L |
|                          |         | 1mm   | 327919 | 245.45 | L |
| 720                      | All     | Std.  | 327937 | 229.90 | L |
|                          |         | .25mm | 327939 | 229.90 | L |
|                          |         | .5mm  | 327941 | 229.90 | L |
|                          |         | .75mm | 327943 | 229.90 | L |
|                          |         | 1mm   | 327945 | 229.90 | L |
| <i>Platinum Series</i>   |         |       |        |        |   |
| 720                      | All     | Std.  | 327938 | 245.45 | L |
|                          |         | .25mm | 327940 | 245.45 | L |
|                          |         | .5mm  | 327942 | 245.45 | L |
|                          |         | .75mm | 327944 | 245.45 | L |
|                          |         | 1mm   | 327946 | 245.45 | L |
| 800                      | All     | Std.  | 327957 | 233.40 | L |
|                          |         | .25mm | 327959 | 233.40 | L |
|                          |         | .5mm  | 327961 | 233.40 | L |
|                          |         | .75mm | 327963 | 233.40 | L |
|                          |         | 1mm   | 327965 | 233.40 | L |
| <i>Platinum Series</i>   |         |       |        |        |   |
| 800                      | All     | Std.  | 327958 | 248.95 | L |
|                          |         | .25mm | 327960 | 248.95 | L |
|                          |         | .5mm  | 327962 | 248.95 | L |
|                          |         | .75mm | 327964 | 248.95 | L |
|                          |         | 1mm   | 327966 | 248.95 | L |
| 800 RFi                  | All     | Std.  | 327814 | 231.40 | L |
|                          |         | .25mm | 327816 | 231.40 | L |
|                          |         | .5mm  | 327818 | 231.40 | L |
|                          |         | .75mm | 327820 | 231.40 | L |
|                          |         | 1mm   | 327822 | 231.40 | L |
| <i>Platinum Series</i>   |         |       |        |        |   |
| 800 RFi                  | All     | Std.  | 327815 | 237.05 | L |
|                          |         | .25mm | 327817 | 237.05 | L |
|                          |         | .5mm  | 327819 | 237.05 | L |
|                          |         | .75mm | 327821 | 237.05 | L |
|                          |         | 1mm   | 327823 | 237.05 | L |
| 951 Carb. Motor          | All     | Std.  | 327977 | 315.55 | L |
|                          |         | .25mm | 327979 | 315.55 | L |
|                          |         | .5mm  | 327981 | 315.55 | L |
|                          |         | .75mm | 327983 | 315.55 | L |
|                          |         | 1mm   | 327985 | 315.55 | L |
| <i>Platinum Series</i>   |         |       |        |        |   |
| 951 Carb. Motor          | All     | Std.  | 327978 | 326.75 | L |
|                          |         | .25mm | 327980 | 326.75 | L |
|                          |         | .5mm  | 327982 | 326.75 | L |
|                          |         | .75mm | 327984 | 326.75 | L |
|                          |         | 1mm   | 327986 | 326.75 | L |
| 951 Di                   | All     | Std.  | 327834 | 317.25 | L |
|                          |         | .25mm | 327836 | 317.25 | L |
|                          |         | .5mm  | 327838 | 317.25 | L |
|                          |         | .75mm | 327840 | 317.25 | L |
|                          |         | 1mm   | 327842 | 317.25 | L |

| MODEL                    | YEAR  | SIZE   | PART # |        |   |
|--------------------------|-------|--------|--------|--------|---|
| <b>SEA-DOO CONTINUED</b> |       |        |        |        |   |
| <i>Platinum Series</i>   |       |        |        |        |   |
| 951 Di                   | All   | Std.   | 327835 | 333.95 | L |
|                          |       | .25mm  | 327837 | 333.95 | L |
|                          |       | .5mm   | 327839 | 333.95 | L |
|                          |       | .75mm  | 327841 | 333.95 | L |
|                          |       | 1mm    | 327843 | 333.95 | L |
| <i>Platinum Series</i>   |       |        |        |        |   |
| 4-Tec & Wake             | 03-07 | Std.   | 329476 | 459.16 | L |
| Gti Non S/C              | 06-07 | .5mm   | 329477 | 459.16 | L |
| <i>Platinum Series</i>   |       |        |        |        |   |
| GTX 4-Tec                | 05-06 | Std.   | -      |        |   |
| 185 HP                   |       | .5mm   | 329478 | 459.16 | L |
| Gtx 4-Tec Ltd.           | 05-13 | Std.   | 329136 | 626.16 | L |
| RXP, RXT                 |       | .5mm   | 329137 | 626.16 | L |
| Supercharged             |       | 1.00mm | -      |        |   |
| 215 / 255 / 260          |       |        |        |        |   |
| <b>TIGER SHARK</b>       |       |        |        |        |   |
| 640                      | All   | Std.   | 328464 | 227.90 | L |
|                          |       | .25mm  | 328465 | 227.90 | L |
|                          |       | .5mm   | 328466 | 227.90 | L |
|                          |       | .75mm  | 328467 | 227.90 | L |
|                          |       | 1mm    | 328468 | 227.90 | L |
| 770                      | All   | Std.   | 328474 | 245.45 | L |
|                          |       | .25mm  | 328475 | 245.45 | L |
|                          |       | .5mm   | 328476 | 245.45 | L |
|                          |       | .75mm  | 328477 | 245.45 | L |
|                          |       | 1mm    | 328478 | 245.45 | L |
| 900                      | All   | Std.   | -      |        |   |
|                          |       | .25mm  | 328484 | 315.55 | L |
|                          |       | .5mm   | 328485 | 315.55 | L |
|                          |       | .75mm  | 328486 | 315.55 | L |
|                          |       | 1mm    | 328487 | 315.55 | L |
| 1000                     | All   | Std.   | 328493 | 315.55 | L |
|                          |       | .25mm  | 328494 | 315.55 | L |
|                          |       | .5mm   | 328495 | 315.55 | L |
|                          |       | .75mm  | 328496 | 315.55 | L |
|                          |       | 1mm    | 328497 | 315.55 | L |
| <b>YAMAHA</b>            |       |        |        |        |   |
| 500                      | All   | Std.   | 327790 | 189.30 | L |
|                          |       | .25mm  | 327791 | 189.30 | L |
|                          |       | .5mm   | 327792 | 189.30 | L |
|                          |       | .75mm  | 327793 | 189.30 | L |
|                          |       | 1mm    | 327794 | 189.30 | L |
| 650 (6M6)                | All   | Std.   | 327800 | 199.85 | L |
|                          |       | .25mm  | 327801 | 199.85 | L |
|                          |       | .5mm   | 327802 | 199.85 | L |
|                          |       | .75mm  | 327803 | 199.85 | L |
|                          |       | 1mm    | 327804 | 199.85 | L |
| 701 (61X)                |       | Std.   | 328182 | 211.15 | L |
|                          |       | .25mm  | 328184 | 211.15 | L |
|                          |       | .5mm   | 328186 | 211.15 | L |
|                          |       | .75mm  | 328188 | 211.15 | L |
|                          |       | 1mm    | 328190 | 211.15 | L |

## PWC ORIGINAL & PLATINUM TOP END REBUILD KITS CONTINUED

| MODEL                   | YEAR  | SIZE  | PART # |        |   |
|-------------------------|-------|-------|--------|--------|---|
| <b>YAMAHA CONTINUED</b> |       |       |        |        |   |
| <i>Platinum Series</i>  |       |       |        |        |   |
| 701 (61X)               |       | Std.  | 328183 | 229.90 | L |
|                         |       | .25mm | 328185 | 229.90 | L |
|                         |       | .5mm  | 328187 | 229.90 | L |
|                         |       | .75mm | 328189 | 229.90 | L |
|                         |       | 1mm   | 328191 | 229.90 | L |
| 701 (62T)               |       | Std.  | 328232 | 208.80 | L |
|                         |       | .25mm | 328234 | 208.80 | L |
|                         |       | .5mm  | 328236 | 208.80 | L |
|                         |       | .75mm | 328238 | 208.80 | L |
|                         |       | 1mm   | 328240 | 208.80 | L |
| <i>Platinum Series</i>  |       |       |        |        |   |
| 701 (62T)               |       | Std.  | 328233 | 229.90 | L |
|                         |       | .25mm | 328235 | 229.90 | L |
|                         |       | .5mm  | 328237 | 229.90 | L |
|                         |       | .75mm | 328239 | 229.90 | L |
|                         |       | 1mm   | 328241 | 229.90 | L |
| 760 (64X)               | All   | Std.  | 328202 | 249.40 | L |
|                         |       | .25mm | 328204 | 249.40 | L |
|                         |       | .50mm | 328206 | 249.40 | L |
|                         |       | .75mm | 328208 | 249.40 | L |
|                         |       | 1mm   | 328210 | 249.40 | L |
| <i>Platinum Series</i>  |       |       |        |        |   |
| 760 (64X)               | All   | Std.  | 328203 | 264.15 | L |
|                         |       | .25mm | 328205 | 264.15 | L |
|                         |       | .5mm  | 328207 | 264.15 | L |
|                         |       | .75mm | 328209 | 264.15 | L |
|                         |       | 1mm   | 328211 | 264.15 | L |
| <i>Platinum Series</i>  |       |       |        |        |   |
| 800                     | All   | Std.  | 328258 | 278.65 | L |
|                         |       | .25mm | 328259 | 278.65 | L |
|                         |       | .5mm  | 328260 | 278.65 | L |
|                         |       | .75mm | 328261 | 278.65 | L |
|                         |       | 1mm   | 328262 | 278.65 | L |
| 1100<br>2 stroke        | All   | Std.  | 328242 | 325.40 | L |
|                         |       | .25mm | 328244 | 325.40 | L |
|                         |       | .5mm  | 328246 | 325.40 | L |
|                         |       | .75mm | 328248 | 325.40 | L |
|                         |       | 1mm   | 328250 | 325.40 | L |
| <i>Platinum Series</i>  |       |       |        |        |   |
| 1100<br>2 stroke        | All   | Std.  | 328243 | 346.65 | L |
|                         |       | .25mm | 328245 | 346.65 | L |
|                         |       | .5mm  | 328247 | 346.65 | L |
|                         |       | .75mm | 328249 | 346.65 | L |
|                         |       | 1mm   | 328251 | 346.65 | L |
| 1200<br>no power valves | 97-99 | Std.  | 328212 | 394.55 | L |
|                         |       | .25mm | 328214 | 394.55 | L |
|                         |       | .5mm  | 328216 | 394.55 | L |
|                         |       | .75mm | 328218 | 394.55 | L |
|                         |       | 1mm   | 328220 | 394.55 | L |
| <i>Platinum Series</i>  |       |       |        |        |   |
| 1200<br>no power valves | 97-99 | Std.  | 328213 | 412.55 | L |
|                         |       | .25mm | 328215 | 412.55 | L |
|                         |       | .5mm  | 328217 | 412.55 | L |
|                         |       | .75mm | 328219 | 412.55 | L |
|                         |       | 1mm   | 328221 | 412.55 | L |

| MODEL   | YEAR  | SIZE   | PART # |        |   |
|---|-------|--------|--------|--------|---|
| <b>YAMAHA CONTINUED</b>                       |       |        |        |        |   |
| <i>Platinum Series</i>                        |       |        |        |        |   |
| 1200 R<br>with power valves                   | 99-00 | Std.   | 328269 | 458.35 | L |
|   |       | .25mm  | 328270 | 458.35 | L |
|   |       | .5mm   | 328271 | 458.35 | L |
|   |       | .75mm  | 328272 | 458.35 | L |
|   |       | 1mm    | 328273 | 458.35 | L |
| <i>Platinum Series</i>                        |       |        |        |        |   |
| 1200R<br>with power valves                    | 01-Up | Std.   | 328275 | 484.30 | L |
|   |       | .25mm  | 328276 | 484.30 | L |
|   |       | .5mm   | 328277 | 484.30 | L |
|   |       | .75mm  | 328278 | 484.30 | L |
|   |       | 1mm    | 328279 | 484.30 | L |
| <i>Platinum Series</i>                        |       |        |        |        |   |
| 1300 GPR                                      | 03-04 | Std.   | 328168 | 445.85 | L |
|   |       | .25mm  | 328169 | 445.85 | L |
|   |       | .5mm   | 328170 | 445.85 | L |
|   |       | .75mm  | 328171 | 445.85 | L |
|   |       | 1mm    | 328172 | 445.85 | L |
| FX 140  | 02-06 | Std.   | 329139 | 484.28 | L |
|   |       | .25mm  | 329140 | 484.28 | L |
|   |       | .5mm   | 329141 | 484.28 | L |
| FX 140 HO                                     | 02-06 | Std.   | 329142 | 484.28 | L |
|   |       | .25mm  | 329143 | 484.28 | L |
|   |       | .5mm   | 329144 | 484.28 | L |
| VX 1100                                       | 05-12 | Std.   | 329144 | 484.28 | L |
|   |       | .25mm  | 329145 | 484.28 | L |
|   |       | .5mm   | 329146 | 484.28 | L |
| <i>Platinum Series</i><br>FX 1800<br>Platinum | 08-15 | Std.   | 329479 | 607.98 | H |
|   |       | .25mm  | 329480 | 607.98 | H |
|   |       | .5mm   | 329481 | 607.98 | H |
|   |       | .75mm  | 329482 | 607.98 | H |
|   |       | 1.00mm | 329483 | 607.98 | H |
| <i>Platinum Series</i>                        |       |        |        |        |   |
| FX 1800 HO                                    | 08-15 | Std.   | 329484 | 651.28 | L |
|   |       | .25mm  | 329485 | 651.28 | L |
|   |       | .5mm   | 329486 | 651.28 | L |
|   |       | .75mm  | 329487 | 651.28 | L |
|   |       | 1.00mm | 329488 | 651.28 | L |

- accessories
- towables
- body
- controls
- electrical
- driveline
- engine**
- fuel & intake
- chemicals
- tie downs
- tools
- towing & loading



MARINE

## RACE QUALITY PWC CONNECTING ROD KITS

Kit includes: Connecting Rod, Bottom Pin, Thrust Washers, Top and Bottom Bearings.



| APPLICATION                         | YEAR    | MFG #      | PART #        |               |   |
|-------------------------------------|---------|------------|---------------|---------------|---|
| <b>KAWASAKI</b>                     |         |            |               |               |   |
| 440/550                             | All     | 010-512    | <b>327696</b> | <b>109.95</b> | G |
| 650                                 | All     | 010-510    | <b>327695</b> | <b>80.00</b>  | L |
| 750 (EARLY STYLE)                   | 93-95   | 010-520    | <b>327704</b> | <b>80.00</b>  | L |
| 750 SXI,ZXI ((LATE STYLE)/800 SXR   | 96-02   | 010-521    | <b>327705</b> | <b>80.00</b>  | L |
| 900                                 | All     | 010-520    | <b>327704</b> | <b>80.00</b>  | L |
| 1100                                | All     | 010-522    | <b>327706</b> | <b>80.00</b>  | L |
| 1200 ULTRA 150                      | All     | 010-542    | <b>327715</b> | <b>96.45</b>  | L |
| <b>POLARIS</b>                      |         |            |               |               |   |
| 650/750/780 (FRONT/MAG, AND MIDDLE) | All     | 010-530-51 | <b>327710</b> | <b>80.00</b>  | L |
| 650/750/780 (REAR/PTO)              | All     | 010-530-54 | <b>327711</b> | <b>80.00</b>  | L |
| 700/1050/900                        | All     | 010-535    | <b>327712</b> | <b>80.00</b>  | L |
| 800 VIRAGE                          | All     | 010-539    | <b>327714</b> | <b>96.45</b>  | L |
| 1200                                | All     | 010-538    | <b>327713</b> | <b>96.45</b>  | L |
| <b>SEA-DOO</b>                      |         |            |               |               |   |
| 580                                 | All     | 010-515    | <b>327698</b> | <b>80.00</b>  | L |
| 650                                 | 94 & UP | 010-516    | <b>327699</b> | <b>80.00</b>  | L |
| 720 (FRONT/MAG)                     | All     | 010-517-53 | <b>327700</b> | <b>80.00</b>  | L |
| 720 (REAR/PTO)                      | All     | 010-517-55 | <b>327701</b> | <b>80.00</b>  | L |
| 800                                 | All     | 010-518    | <b>327702</b> | <b>80.00</b>  | L |
| 951                                 | All     | 010-519    | <b>327703</b> | <b>80.00</b>  | L |
| 4 TEC                               | All     | 010-514    | <b>327697</b> | <b>96.50</b>  | G |
| <b>TIGER SHARK</b>                  |         |            |               |               |   |
| 639/640                             | 93-99   | 010-550    | <b>327716</b> | <b>96.45</b>  | L |
| 770                                 | 96-99   | 010-551    | <b>327717</b> | <b>96.45</b>  | L |
| 1000                                | 95-99   | 010-552    | <b>327718</b> | <b>96.45</b>  | L |
| <b>YAMAHA</b>                       |         |            |               |               |   |
| 500                                 | All     | 010-501    | <b>327694</b> | <b>96.45</b>  | L |
| 800/1200R/1300R                     | All     | 010-528    | <b>327708</b> | <b>96.45</b>  | L |
| 650/701/760/1100/1200               | All     | 010-525    | <b>327707</b> | <b>80.00</b>  | L |
| FX 140, H.O. VX 1100                | All     | 010-529    | <b>327709</b> | <b>95.00</b>  | J |
| 1800                                | 04-15   | 010-573    | <b>327719</b> | <b>150.25</b> | L |

- accessories
- towables
- body
- controls
- electrical
- driveline
- engine**
- fuel & intake
- chemicals
- tie downs
- tools
- towing & loading

## HOT RODS CRANKSHAFTS

Building on the success of high-quality, OEM replacement rods, Hot Rods introduced the perfect place to showcase them — in a Hot Rods OEM replacement crankshaft. Since that time, Hot Rods crankshafts have been regarded as the premier alternative to costly manufacturer cranks. But, in addition to being a cost effective alternative, Hot Rods crankshafts also bring a level of uncompromising quality, design and innovation not seen in its competitors. One such innovation would be the Hot Rods line of drop-in stroker crankshafts. Not only do these stroker cranks bring about a heightened level of performance, but do so without costly case machining, custom cam chains and spacer plates. Better yet, many Hot Rods stroker cranks even utilize the engine's stock piston.



| APPLICATION     | YEAR      | PART #        |                 |
|-----------------|-----------|---------------|-----------------|
| <b>KAWASAKI</b> |           |               |                 |
| 1100 ZXI        | 1996-2003 | <b>870712</b> | <b>949.95</b> G |
| 900 STS         | 2001-2002 | <b>870713</b> | <b>799.95</b> G |
| 900 STX         | 1997-2006 | <b>870713</b> | <b>799.95</b> G |
| 900 ZXI         | 1995-1997 | <b>870713</b> | <b>799.95</b> G |
| JS 750          | 1995-2002 | <b>870709</b> | <b>499.95</b> G |
| JS 800 SX-R     | 2003-2011 | <b>870709</b> | <b>499.95</b> G |
| <b>SEA-DOO</b>  |           |               |                 |
| 720             | 1995-2005 | <b>870705</b> | <b>649.95</b> G |
| 720 HX          | 1995-2005 | <b>870705</b> | <b>649.95</b> G |
| 720 XP          | 1995-2005 | <b>870705</b> | <b>649.95</b> G |
| 785             | 1996-1999 | <b>870706</b> | <b>698.95</b> G |
| 951 CARBURETED  | 1998-2002 | <b>870707</b> | <b>799.95</b> G |
| 951 DI          | 2000-2007 | <b>870708</b> | <b>749.95</b> G |

## CONNECTING RODS

One single connecting rod is where it all began for Hot Rods and, now, with over a decade of experience, continuously improved designs and an ever expanding line of applications; Hot Rods has continued to be, not only "The Original" aftermarket replacement rod, but the best aftermarket replacement rod. All of our rods are created from 8620 case hardened steel. But, in addition to that, our rods also undergo a process of double forging which helps to improve grain flow as well as dimensional consistency — and that means a rod of uncompromising strength. To improve fatigue durability, all of our rods are also shot peened. This process, utilizing a stainless steel shot, helps to remove stress risers and creates more smoothly blended radiuses. And, in the end, a Hot Rods connecting rod is one of the most durable rods that enthusiasts and engine builders can buy. However, a rod is only as good as its supporting parts and that's why a Hot Rods kit features only the most advanced and durable bearings, crank pins and thrust washers. Case hardened, silver coated, flat profile KU bearings are used throughout our entire line and high-quality, long shouldered KZ bearings are used in our two-stroke wrist pin bearing applications. In short, our bearings are just as tough and reliable as our rods. Even our crank pins are subjected to the same rigorous standards as our rods and bearings. Each Hot Rods crank pin is created from hot-rolled ASTM 4115 steel and case-hardened to a level of 58–62 Rc.



| APPLICATION     | YEAR      | PART #        |                 |
|-----------------|-----------|---------------|-----------------|
| <b>KAWASAKI</b> |           |               |                 |
| 1100 ZXI        | 1996-2003 | <b>870484</b> | <b>109.95</b> G |
| 900 STS         | 2001-2002 | <b>870476</b> | <b>109.95</b> G |
| 900 STX         | 1997-2006 | <b>870476</b> | <b>109.95</b> G |
| 900 ZXI         | 1995-1997 | <b>870476</b> | <b>109.95</b> G |
| JS 440          | 1980-1992 | <b>870477</b> | <b>109.95</b> G |
| JS 550          | 1982-1985 | <b>870477</b> | <b>109.95</b> G |
| JS 750          | 1992-1995 | <b>870476</b> | <b>109.95</b> G |
| JS 750          | 1995-2002 | <b>870483</b> | <b>109.95</b> G |
| JS 800 SX-R     | 2003-2011 | <b>870483</b> | <b>109.95</b> G |
| STXR            | 2002-2005 | <b>870502</b> | <b>109.95</b> G |
| SXI             | 1995-2002 | <b>870484</b> | <b>109.95</b> G |
| ULTRA 150       | 1995-2005 | <b>870502</b> | <b>109.95</b> G |

| APPLICATION          | YEAR      | PART #        |                 |
|----------------------|-----------|---------------|-----------------|
| <b>YAMAHA</b>        |           |               |                 |
| EXCITER 1100 JETBOAT | 1996-1998 | <b>870714</b> | <b>949.95</b> G |
| EXCITER JETBOAT      | 1998-1999 | <b>870703</b> | <b>899.95</b> G |
| GP 1200 WAVERUNNER   | 1997-1999 | <b>870703</b> | <b>899.95</b> G |
| GP 1200 WAVERUNNER   | 2000-2002 | <b>870710</b> | <b>999.95</b> G |
| GP 1300 WAVERUNNER   | 2003-2006 | <b>870710</b> | <b>999.95</b> G |
| GP 800               | 1998-2005 | <b>870711</b> | <b>699.95</b> G |
| GP 800R              | 1998-2005 | <b>870711</b> | <b>699.95</b> G |
| LST 1200 JETBOAT     | 1999-2005 | <b>870703</b> | <b>899.95</b> G |
| RA 1100 WAVERAIDER   | 1995-1996 | <b>870714</b> | <b>949.95</b> G |
| SV 1200 WAVERUNNER   | 1999-2004 | <b>870703</b> | <b>899.95</b> G |
| WVT 1100 WAVEVENTURE | 1996-1997 | <b>870714</b> | <b>949.95</b> G |
| XA 1200 WAVERUNNER   | 1999-2005 | <b>870710</b> | <b>999.95</b> G |
| XL 1200 WAVERUNNER   | 1998      | <b>870703</b> | <b>899.95</b> G |
| XR 1800 JETBOAT      | 2000-2001 | <b>870710</b> | <b>999.95</b> G |
| SJ 700               | 1998-2015 | <b>870702</b> | <b>599.95</b> G |
| SUPER JET 650        | 1990-1993 | <b>870702</b> | <b>599.95</b> G |
| WAVE RUNNER XL 700   | 1999-2004 | <b>870702</b> | <b>599.95</b> G |
| WAVE VENTURE 700     | 1998      | <b>870702</b> | <b>599.95</b> G |

| APPLICATION    | YEAR      | PART #        |                 |
|----------------|-----------|---------------|-----------------|
| <b>POLARIS</b> |           |               |                 |
| 1050 SL        | 1996-1999 | <b>870481</b> | <b>89.95</b> G  |
| 1200 SLX       | 2000-2001 | <b>870503</b> | <b>119.95</b> G |
| 650 SL         | 1992-1995 | <b>870489</b> | <b>109.95</b> G |
| 650 SL         | 1992-1995 | <b>870480</b> | <b>89.95</b> G  |
| 700 SL         | 1996-1997 | <b>870481</b> | <b>89.95</b> G  |
| 750 SL         | 1993-1995 | <b>870489</b> | <b>109.95</b> G |
| 750 SL         | 1993-1995 | <b>870480</b> | <b>89.95</b> G  |
| 780 SL         | 1995-1997 | <b>870489</b> | <b>109.95</b> G |
| 780 SL         | 1995-1997 | <b>870480</b> | <b>89.95</b> G  |
| 900 SL         | 1996-1997 | <b>870481</b> | <b>89.95</b> G  |

| APPLICATION    | YEAR      | PART #        |                 |
|----------------|-----------|---------------|-----------------|
| <b>SEA-DOO</b> |           |               |                 |
| 650            | 1997      | <b>870479</b> | <b>109.95</b> G |
| 720 HX PTO     | 1995-2002 | <b>870491</b> | <b>109.95</b> G |
| 720 HX MAG     | 1995-2002 | <b>870478</b> | <b>109.95</b> G |
| 720 XP PTO     | 1995-2002 | <b>870491</b> | <b>109.95</b> G |
| 720 XP MAG     | 1995-2002 | <b>870478</b> | <b>109.95</b> G |
| 785            | 1996-1999 | <b>870482</b> | <b>109.95</b> G |
| 951 CARBURETED | 1998-2002 | <b>870500</b> | <b>109.95</b> G |
| 951 DI         | 2000-2007 | <b>870504</b> | <b>109.95</b> G |

| APPLICATION          | YEAR      | PART #        |                 |
|----------------------|-----------|---------------|-----------------|
| <b>YAMAHA</b>        |           |               |                 |
| EXCITER 1100 JETBOAT | 1996-1998 | <b>870492</b> | <b>109.95</b> G |
| EXCITER JETBOAT      | 1998-1999 | <b>870492</b> | <b>109.95</b> G |
| GP 1200 WAVERUNNER   | 1997-1999 | <b>870492</b> | <b>109.95</b> G |
| GP 1200 WAVERUNNER   | 2000-2002 | <b>870501</b> | <b>109.95</b> G |
| GP 1300 WAVERUNNER   | 2003-2006 | <b>870501</b> | <b>109.95</b> G |
| GP 800               | 1998-2005 | <b>870501</b> | <b>109.95</b> G |
| GP 800R              | 1998-2005 | <b>870501</b> | <b>109.95</b> G |
| LST 1200 JETBOAT     | 1999-2005 | <b>870492</b> | <b>109.95</b> G |
| RA 1100 WAVERAIDER   | 1995-1996 | <b>870492</b> | <b>109.95</b> G |
| SV 1200 WAVERUNNER   | 1999-2004 | <b>870492</b> | <b>109.95</b> G |
| WVT 1100 WAVEVENTURE | 1996-1997 | <b>870492</b> | <b>109.95</b> G |
| XA 1200 WAVERUNNER   | 1999-2005 | <b>870501</b> | <b>109.95</b> G |
| XL 1200 WAVERUNNER   | 1998      | <b>870492</b> | <b>109.95</b> G |
| XR 1800 JETBOAT      | 2000-2001 | <b>870501</b> | <b>109.95</b> G |
| SJ 700               | 1998-2015 | <b>870492</b> | <b>109.95</b> G |
| SUPER JET 650        | 1990-1993 | <b>870492</b> | <b>109.95</b> G |
| WAVE RUNNER XL 700   | 1999-2004 | <b>870492</b> | <b>109.95</b> G |
| WAVE VENTURE 700     | 1998      | <b>870492</b> | <b>109.95</b> G |

- accessories
- towables
- body
- controls
- electrical
- driveline
- engine**
- fuel & intake
- chemicals
- tie downs
- tools
- towing & loading

# MARINE

- accessories
- towables
- body
- controls
- electrical
- driveline
- engine**
- fuel & intake
- chemicals
- tie downs
- tools
- towing & loading



**NEW PRODUCT**

## COUNTER BALANCER

- Counter-balancer for popular Sea Doo 951 carbureted models
- Ready to help you get back on the water fast
- Complete counter-balance shaft is the result of Hot Rods continued commitment to keep providing the most reliable products for engines
- Manufactured from completely new materials

| APPLICATION    | YEAR      | PART #        |            |
|----------------|-----------|---------------|------------|
| <b>SEA-DOO</b> |           |               |            |
| 951 CARBURETED | 1998-2002 | <b>850507</b> | <b>TBA</b> |



## PERSONAL WATERCRAFT BOTTOM END KITS



Kit contains crankshaft, main bearing/seals and complete gasket set to complete installation.

| APPLICATION     | YEAR      | PART #        |                |   |
|-----------------|-----------|---------------|----------------|---|
| <b>KAWASAKI</b> |           |               |                |   |
| 1100 ZXI        | 1996-2003 | <b>871294</b> | <b>1044.95</b> | G |
| JS 750          | 1995-2002 | <b>871292</b> | <b>557.95</b>  | G |
| JS 800 SX-R     | 2003-2006 | <b>871293</b> | <b>599.95</b>  | G |
| <b>SEA-DOO</b>  |           |               |                |   |
| 720             | 1995-2004 | <b>871295</b> | <b>716.95</b>  | G |
| 720 HX          | 1995-2004 | <b>871295</b> | <b>716.95</b>  | G |
| 720 XP          | 1995-2004 | <b>871295</b> | <b>716.95</b>  | G |
| 785             | 1996-1999 | <b>871296</b> | <b>780.95</b>  | G |
| 951 CARBURETED  | 1998-2000 | <b>871297</b> | <b>908.95</b>  | G |
| 951 CARBURETED  | 2001-2002 | <b>871298</b> | <b>908.95</b>  | G |
| 951 DI          | 2000-2007 | <b>871299</b> | <b>879.95</b>  | G |

| APPLICATION        | YEAR      | PART #        |                |   |
|--------------------|-----------|---------------|----------------|---|
| <b>YAMAHA</b>      |           |               |                |   |
| GP 1200 WAVERUNNER | 2000-2002 | <b>871303</b> | <b>1249.95</b> | G |
| GP 1300 WAVERUNNER | 2003-2005 | <b>871304</b> | <b>1249.95</b> | G |
| GP 800             | 1998-2005 | <b>871305</b> | <b>819.95</b>  | G |
| GP 800R            | 1998-2005 | <b>871305</b> | <b>819.95</b>  | G |
| XA 1200 WAVERUNNER | 1999-2005 | <b>871303</b> | <b>1249.95</b> | G |
| XR 1800 JETBOAT    | 2000-2001 | <b>871303</b> | <b>1249.95</b> | G |
| SJ 700             | 1998-2004 | <b>871302</b> | <b>699.95</b>  | G |
| SUPER JET 650      | 1990-1993 | <b>871300</b> | <b>699.95</b>  | G |
| WAVE RUNNER XL 700 | 1999-2002 | <b>871301</b> | <b>699.95</b>  | G |
| WAVE VENTURE 700   | 1998      | <b>871301</b> | <b>699.95</b>  | G |



## MAIN BEARING & SEAL KIT

To compliment Hot Rods full line of heavy duty OEM replacement and stroker crankshafts are Hot Rods complete main bearing and seal kits for both two and four-stroke applications. Like other Hot Rods products, these main bearing and seal kits are built to the highest quality standards that meet or exceed those of OEM.

Additionally, not only will Hot Rods main bearing and seal kits work in rebuilding a Hot Rods crankshaft; but, they also work in rebuilding OEM cranks as well.

| APPLICATION     | YEAR      | PART #        |              |   |
|-----------------|-----------|---------------|--------------|---|
| <b>KAWASAKI</b> |           |               |              |   |
| 1100 ZXI        | 1996-2003 | <b>870715</b> | <b>44.95</b> | G |
| 900 STS         | 2001-2002 | <b>870715</b> | <b>44.95</b> | G |
| 900 STX         | 1997-2006 | <b>870715</b> | <b>44.95</b> | G |
| 900 ZXI         | 1995-1997 | <b>870715</b> | <b>44.95</b> | G |







## PWC TOP END ENGINE GASKETS

- Everything you need to swap out those old gaskets for new replacements -- head, base, reed, intake, manifold and exhaust gaskets (where applicable) Does not include oil seals.
- State-of-the-art graphite head gaskets are made of non-asbestos flexible graphite, laminated to a stainless steel core
- Graphite material extracts heat away from the combustion area, eliminating hot spots
- Cometic graphite material is impervious to fuels, coolant and oil
- Maximum seal and flexibility are obtained with excellent torque retention
- Cometic gaskets provide years of service with proper installation

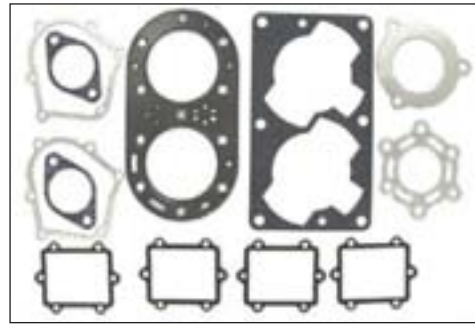

| APPLICATION        | YEAR  | SIZE   | MFG # | PART #         |
|--------------------|-------|--------|-------|----------------|
| <b>ARTCO</b>       |       |        |       |                |
| Barracuda          | 94-95 | 77mm   | C6052 | 912410 44.97 L |
| Daytona            | 94-95 | 77mm   | C6052 | 912410 44.97 L |
| Daytona            | 96-97 | 84mm   | C6144 | 912425 60.81 L |
| Daytona 1000       | 97    | O-Ring | C6116 | 912419 72.97 L |
| Monte Carlo        | 96-97 | 84mm   | C6144 | 912425 60.81 L |
| Monte Carlo 900    | 96    | O-Ring | C6116 | 912419 72.97 L |
| Montego            | 94-97 | 77mm   | C6052 | 912410 44.97 L |
| Montego deluxe     | 94-97 | 77mm   | C6052 | 912410 44.97 L |
| Tigershark         | 93    | 77mm   | C6052 | 912410 44.97 L |
| Tigershark 900     | 95    | O-Ring | C6116 | 912419 72.97 L |
| Tigershark Daytona | 93    | 77mm   | C6052 | 912410 44.97 L |
| TS640L             | 98    | 77mm   | C6052 | 912410 44.97 L |
| Ts770              | 98-99 | 84mm   | C6144 | 912425 60.81 L |
| TS-I1000           | 98    | O-Ring | C6162 | 912437 72.97 L |
| Ts-I770            | 98-99 | 84mm   | C6144 | 912425 60.81 L |
| TS-R               | 98-99 | 84mm   | C6144 | 912425 60.81 L |
| TS-R1000           | 98    | O-Ring | C6162 | 912437 72.97 L |
| TT640R             | 98-99 | 77mm   | C6052 | 912410 44.97 L |
| <b>KAWASAKI</b>    |       |        |       |                |
| 1100STX            | 97-99 | 81mm   | C6145 | 912426 72.97 L |
| 1100STX            | 97-99 | 84.5mm | C6159 | 912435 85.12 L |
| 1100ZXi            | 96-03 | 81mm   | C6145 | 912426 72.97 L |
| 1100Zxi            | 96-03 | 84.5mm | C6159 | 912435 85.12 L |
| 1200STX            | 02-05 | 81mm   | C6202 | 912441 85.12 L |
| 750SXI             | 98-02 | 83mm   | C6043 | 912408 42.54 L |
| 750XI              | 95-97 | 81mm   | C6215 | 912445 42.54 L |
| 750ZXI             | 95-97 | 83mm   | C6043 | 912408 42.54 L |
| 750ZXi             | 95-97 | 83mm   | C6126 | 912423 42.54 L |
| 750ZXi             | 95-97 | 84.5mm | C6158 | 912434 42.54 L |
| 800 SXR            | 03-06 | 82mm   | C6214 | 912444 58.99 L |
| 900ZXi             | 95-97 | 75mm   | C6118 | 912420 60.81 L |
| JF650TS            | 89-96 | 78mm   | C6005 | 912404 42.54 L |
| JF650TS            | 89-96 | 80mm   | C6078 | 912414 42.54 L |
| JF650X2            | 86-95 | 78mm   | C6005 | 912404 42.54 L |
| JF650X2            | 86-95 | 80mm   | C6078 | 912414 42.54 L |
| JH750SS            | 92-97 | 83mm   | C6043 | 912408 42.54 L |
| JH750SXI           | 93-97 | 83mm   | C6043 | 912408 42.54 L |
| JH750XIR           | 94    | 83mm   | C6043 | 912408 42.54 L |
| JS300              | 86-94 | 78mm   | C6001 | 912400 21.86 L |
| JS300SX            | 86-94 | 78mm   | C6001 | 912400 21.86 L |
| JS440              | 82-92 | 70mm   | C6002 | 912401 39.99 L |
| JS440              | 82-92 | 73mm   | C6003 | 912402 39.99 L |
| JS550              | 89-95 | 77mm   | C6015 | 912407 59.57 L |

| APPLICATION               | YEAR  | SIZE    | MFG # | PART #         |
|---------------------------|-------|---------|-------|----------------|
| <b>KAWASAKI CONTINUED</b> |       |         |       |                |
| JS550                     | 82-88 | 77mm    | C6004 | 912403 59.57 L |
| JS650SC                   | 91-95 | 78mm    | C6005 | 912404 42.54 L |
| JS650SC                   | 91-95 | 80mm    | C6078 | 912414 42.54 L |
| JS650SX                   | 87-93 | 80mm    | C6078 | 912414 42.54 L |
| JS650SX                   | 87-93 | 78mm    | C6005 | 912404 42.54 L |
| JS750SX                   | 92-95 | 83MM    | C6043 | 912408 42.54 L |
| JS750SXI                  | 95-97 | 83MM    | C6043 | 912408 42.54 L |
| JSX440                    | 82-92 | 70mm    | C6002 | 912401 39.99 L |
| JSX440                    | 82-92 | 73mm    | C6003 | 912402 39.99 L |
| JSX440SX                  | 82-92 | 70mm    | C6002 | 912401 39.99 L |
| JSX440SX                  | 82-92 | 73mm    | C6003 | 912402 39.99 L |
| JSX550                    | 89-95 | 77mm    | C6015 | 912407 59.57 L |
| JT750ST                   | 94-95 | 83MM    | C6043 | 912408 42.54 L |
| JT750STS                  | 95-97 | 83MM    | C6043 | 912408 42.54 L |
| STX                       | 98    | 81mm    | C6215 | 912445 42.54 L |
| STX                       | 98    | 83mm    | C6126 | 912423 42.54 L |
| STX                       | 98    | 84.5mm  | C6158 | 912434 42.54 L |
| STX                       | 97-06 | 75mm    | C6118 | 912420 60.81 L |
| STX D.I.                  | 00-03 | 81mm    | C6145 | 912426 72.97 L |
| STX D.I.                  | 00-03 | 84.5mm  | C6159 | 912435 85.12 L |
| SX800R                    | 03-06 | 83mm    | C6126 | 912423 42.54 L |
| SX800R                    | 03-06 | 84.5mm  | C6158 | 912434 42.54 L |
| SXI PRO                   | 98-02 | 81mm    | C6215 | 912445 42.54 L |
| SXI PRO                   | 98-02 | 83mm    | C6126 | 912423 42.54 L |
| SXI PRO                   | 98-02 | 84.5mm  | C6158 | 912434 42.54 L |
| Ultra 150                 | 99-05 | 81mm    | C6202 | 912441 85.12 L |
| <b>POLARIS</b>            |       |         |       |                |
| Genesis Ffi               | 00-04 | 86mm    | C6212 | 912443 97.27 L |
| PRO 1200                  | 00-04 | 86mm    | C6212 | 912443 97.27 L |
| SL1050                    | 96-04 | O-Ring  | C6148 | 912429 60.81 L |
| SL650                     | 92-95 | 67mm    | C6044 | 912409 60.81 L |
| SL650STD                  | 92-95 | 67mm    | C6044 | 912409 60.81 L |
| SL700                     | 96-03 | O-Ring  | C6146 | 912427 72.97 L |
| SL700DLX                  | 96-03 | O-Ring  | C6146 | 912427 72.97 L |
| SL750                     | 92-96 | 71.25mm | C6055 | 912411 72.97 L |
| SL750                     | 92-96 | 72mm    | C6089 | 912417 72.97 L |
| SL780                     | 95-96 | 71.5mm  | C6143 | 912424 60.81 L |
| SL900                     | 96-97 | O-Ring  | C6147 | 912428 60.81 L |
| SLH                       | 96-03 | O-Ring  | C6146 | 912427 72.97 L |
| SLT                       | 92-96 | 72mm    | C6089 | 912417 72.97 L |
| SLT                       | 92-96 | 71.25mm | C6055 | 912411 72.97 L |
| SLT 700                   | 96-03 | O-Ring  | C6146 | 912427 72.97 L |
| SLT780                    | 95-96 | 71.5mm  | C6143 | 912424 60.81 L |

- accessories
- towables
- body
- controls
- electrical
- driveline
- engine
- fuel & intake
- chemicals
- tie downs
- tools
- towing & loading

# MARINE

## COMETIC PWC TOP END ENGINE GASKETS CONTINUED

accessories  
towables  
body  
controls  
electrical  
driveline  
**engine**  
fuel & intake  
chemicals  
tie downs  
tools  
towing & loading

MARINE

| APPLICATION              | YEAR  | SIZE   | MFG # | PART #         |
|--------------------------|-------|--------|-------|----------------|
| <b>POLARIS CONTINUED</b> |       |        |       |                |
| SLTH                     | 96-03 | O-Ring | C6146 | 912427 72.97 L |
| SLTX1050                 | 97-04 | O-Ring | C6148 | 912429 60.81 L |
| SLX                      | 00-04 | 86mm   | C6212 | 912443 97.27 L |
| SLX 785 Pro              | 97-01 | 72mm   | C6181 | 912439 60.81 L |
| SLX780                   | 95-97 | 71.5mm | C6143 | 912424 60.81 L |
| SLXH                     | 98-04 | O-Ring | C6148 | 912429 60.81 L |
| VIRAGE TX                | 00-04 | 86mm   | C6212 | 912443 97.27 L |
| <b>SEA-DOO</b>           |       |        |       |                |
| 580 White Motor          | 92-96 | O-Ring | C6095 | 912418 60.81 L |
| 580 Yellow Motor         | 91    | O-Ring | C6010 | 912405 60.81 L |
| 580GT                    | 90-91 | O-Ring | C6010 | 912405 60.81 L |
| 580SP                    | 92-96 | O-Ring | C6095 | 912418 60.81 L |
| 580XP                    | 91    | O-Ring | C6010 | 912405 60.81 L |
| 650SPX                   | 94-95 | O-Ring | C6056 | 912412 60.81 L |
| 650XP                    | 93-94 | O-Ring | C6056 | 912412 60.81 L |
| 650XPI                   | 94-95 | O-Ring | C6056 | 912412 60.81 L |
| GS750                    | 97-01 | O-Ring | C6119 | 912421 60.81 L |
| GSX800                   | 97-01 | O-Ring | C6154 | 912431 60.81 L |
| GSX950 Limited           | 97-99 | 90mm   | C6157 | 912433 97.27 L |
| GSX950 Limited           | 97-99 | 90mm   | C6203 | 912442 97.27 L |
| GTI750                   | 97-01 | O-Ring | C6119 | 912421 60.81 L |
| GTS                      | 92-96 | O-Ring | C6095 | 912418 60.81 L |
| GTS750                   | 97-01 | O-Ring | C6119 | 912421 60.81 L |
| GTX                      | 92-96 | O-Ring | C6095 | 912418 60.81 L |
| GTX 650                  | 94-95 | O-Ring | C6056 | 912412 60.81 L |
| GTX800                   | 97-01 | O-Ring | C6154 | 912431 60.81 L |
| GTX950                   | 00    | 90mm   | C6157 | 912433 97.27 L |
| GTX950                   | 00    | 90mm   | C6203 | 912442 97.27 L |
| GTX950 Limited           | 98-00 | 90mm   | C6157 | 912433 97.27 L |
| GTX950 Limited           | 98-00 | 90mm   | C6203 | 912442 97.27 L |
| HX750                    | 97-01 | O-Ring | C6119 | 912421 60.81 L |
| LRV950                   | 00    | 90mm   | C6157 | 912433 97.27 L |
| LRV950                   | 00    | 90mm   | C6203 | 912442 97.27 L |
| RFI800*                  | 97-01 | O-Ring | C6154 | 912431 60.81 L |
| RX950                    | 00    | 90mm   | C6157 | 912433 97.27 L |
| RX950                    | 00    | 90mm   | C6203 | 912442 97.27 L |
| SPI                      | 92-96 | O-Ring | C6095 | 912418 60.81 L |
| SPX                      | 92-96 | O-Ring | C6095 | 912418 60.81 L |
| SPX750                   | 97-01 | O-Ring | C6119 | 912421 60.81 L |
| SPX800                   | 97-01 | O-Ring | C6154 | 912431 60.81 L |
| XP                       | 92-96 | O-Ring | C6095 | 912418 60.81 L |
| XP 800                   | 97-01 | O-Ring | C6154 | 912431 60.81 L |
| XP750                    | 97-01 | O-Ring | C6119 | 912421 60.81 L |
| XP800                    | 97-01 | O-Ring | C6154 | 912431 60.81 L |
| XP950 Limited            | 98-00 | 90mm   | C6157 | 912433 97.27 L |
| XP950 Limited            | 98-00 | 90mm   | C6203 | 912442 97.27 L |

\*Lay down motor

| APPLICATION        | YEAR  | SIZE | MFG # | PART #         |
|--------------------|-------|------|-------|----------------|
| <b>YAMAHA</b>      |       |      |       |                |
| 1200 GP            | 97-99 | 86mm | C6160 | 912436 97.27 L |
| 800 GP             | 98-00 | 86mm | C6199 | 912440 47.41 L |
| FX700*             | 94-95 | 83mm | C6057 | 912413 43.77 L |
| LX633              | 90-96 | 79mm | C6012 | 912406 43.77 L |
| PRO -VXR*          | 93-91 | 83mm | C6057 | 912413 43.77 L |
| Super Jet          | ALL   | 79mm | C6012 | 912406 43.77 L |
| Super Jet *        | 94-96 | 83mm | C6057 | 912413 43.77 L |
| Super Jet **       | 97-00 | 83mm | C6084 | 912415 47.41 L |
| Super Jet **       | 97-00 | 85mm | C6086 | 912416 47.41 L |
| SUV1200            | 00    | 86mm | C6160 | 912436 97.27 L |
| VXR                | 91-95 | 79mm | C6012 | 912406 43.77 L |
| Wave Venture 1100  | 96-97 | 83mm | C6121 | 912422 97.27 L |
| Wave Venture 700** | 95-97 | 83mm | C6084 | 912415 47.41 L |
| Wave Venture 700** | 95-97 | 85mm | C6086 | 912416 47.41 L |
| Wave Venture 760   | 97    | 85mm | C6149 | 912430 47.41 L |
| Wave Venture 760   | 97    | 86mm | C6155 | 912432 47.41 L |
| Waveblaster II     | 96-99 | 85mm | C6149 | 912430 47.41 L |
| Waveblaster II     | 96-99 | 86mm | C6155 | 912432 47.41 L |
| Waveblaster*       | 93-95 | 83mm | C6057 | 912413 43.77 L |
| Waveblaster**      | 96-97 | 83mm | C6084 | 912415 47.41 L |
| Waveblaster**      | 96-97 | 85mm | C6086 | 912416 47.41 L |
| Waveraider 1100    | 95-97 | 83mm | C6121 | 912422 97.27 L |
| Waveraider 700*    | 96-99 | 83mm | C6057 | 912413 43.77 L |
| Waveraider 700**   | 93-95 | 83mm | C6084 | 912415 47.41 L |
| Waveraider 700**   | 93-95 | 85mm | C6086 | 912416 47.41 L |
| Waveraider 760     | 96-99 | 85mm | C6149 | 912430 47.41 L |
| Waveraider 760     | 96-99 | 86mm | C6155 | 912432 47.41 L |
| Waveraider Dlx **  | 93-95 | 83mm | C6084 | 912415 47.41 L |
| Waveraider Dlx **  | 93-95 | 85mm | C6086 | 912416 47.41 L |
| Waverunner         | 96-97 | 85mm | C6149 | 912430 47.41 L |
| Waverunner         | 96-97 | 86mm | C6155 | 912432 47.41 L |
| Waverunner         | 90-93 | 79mm | C6012 | 912406 43.77 L |
| Waverunner GP760   | 00    | 85mm | C6149 | 912430 47.41 L |
| Waverunner III     | 90-93 | 79mm | C6012 | 912406 43.77 L |
| Waverunner III *   | 94-97 | 83mm | C6057 | 912413 43.77 L |
| XI1200             | 00    | 86mm | C6160 | 912436 97.27 L |
| XL700**            | 99-00 | 83mm | C6084 | 912415 47.41 L |
| XL700**            | 99-00 | 85mm | C6086 | 912416 47.41 L |

\*Kit works with all single carb models \*\*Kit works with all dual carb models



## PERSONAL WATERCRAFT GASKET SETS



### TOP END GASKET SETS

These sets include the head, base and upper end gaskets - designed for piston replacement.

### COMPLETE GASKET SETS WITH OIL SEALS

These sets include all gaskets and oil seals necessary to rebuild the engine.

| APPLICATION        | YEAR      | CC   | CYL. | TOP END GASKET SET |        |   | COMPLETE SET WITH OIL SEALS |        |   | OIL SEAL SET |       |   |
|--------------------|-----------|------|------|--------------------|--------|---|-----------------------------|--------|---|--------------|-------|---|
| <b>ARCTCO™</b>     |           |      |      |                    |        |   |                             |        |   |              |       |   |
| TIGERSHARK 640     | 93-99     | 639  | 2    | 837732             | 41.95  | L | 837784                      | 65.95  | L | 837824       | 17.95 | L |
| TIGERSHARK 900     | 95-96, 99 | 896  | 3    | 837733             | 74.95  | L | 837785                      | 85.95  | L | 837825       | 13.95 | L |
| TIGERSHARK 1000    | 97-98     | 999  | 3    | 837734             | 74.95  | L | 837786                      | 85.95  | L | 837825       | 13.95 | L |
| TIGERSHARK 1100 R  | 99        | 1000 | 3    | 837734             | 74.95  | L | 837786                      | 85.95  | L | 837825       | 13.95 | L |
| <b>KAWASAKI™</b>   |           |      |      |                    |        |   |                             |        |   |              |       |   |
| JS300              | 86-91     | 295  | 1    | 837705             | 22.95  | L | 837756                      | 37.95  | L | 837808       | 9.95  | L |
| JS440              | 82-88     | 436  | 2    | 837706             | 31.95  | L | 837757                      | 57.95  | L | 837809       | 14.95 | L |
| JS440              | 89-92     | 436  | 2    | 837707             | 31.95  | L | 837758                      | 57.95  | L | 837809       | 14.95 | L |
| JS550              | 82-90     | 531  | 2    | 837708             | 33.95  | L | 837759                      | 62.95  | L | 837809       | 14.95 | L |
| JS550SX            | 91-95     | 531  | 2    | 837723             | 39.95  | L | 837775                      | 64.95  | L | 837809       | 14.95 | L |
| JS650              | 86-96     | 635  | 2    | 837709             | 37.95  | L | 837760                      | 64.95  | L | 837810       | 14.95 | L |
| JS750 SX, SXI, PRO | 92-02     | 743  | 2    | 837724             | 37.95  | L | 837776                      | 64.95  | L | 837810       | 14.95 | L |
| JH750 SS,XI        | 93-99     | 743  | 2    | 837724             | 37.95  | L | 837779                      | 65.95  | L | 837810       | 14.95 | L |
| JT750 ST,STS,STX   | 92-98     | 743  | 2    | 837724             | 37.95  | L | 837779                      | 65.95  | L | 837810       | 14.95 | L |
| JH750 ZXI          | 95-97     | 743  | 2    | 837724             | 37.95  | L | 837780                      | 65.95  | L | 837810       | 14.95 | L |
| JS800 SX           | 03-06     | 800  | 2    | 837727             | 73.95  | L | 837781                      | 122.95 | L | 837810       | 14.95 | L |
| JH900, JT 900      | 95-06     | 900  | 3    | 837725             | 86.95  | L | 837777                      | 116.95 | L | 837821       | 19.95 | L |
| JH1100,JT1100      | 96-04     | 1071 | 3    | 837726             | 93.95  | L | 837778                      | 116.95 | L | 837821       | 19.95 | L |
| ULTRA 130          | 04        | 1071 | 3    | 837726             | 93.95  | L | 837778                      | 116.95 | L | 837821       | 19.95 | L |
| ULTRA 150          | 99        | 1176 | 3    | 837728             | 172.95 | L | 837783                      | 214.95 | L | 837822       | 26.95 | L |
| ULTRA 150          | 00-05     | 1176 | 3    | 837728             | 172.95 | L | 837782                      | 214.95 | L | 837823       | 26.95 | L |
| 1200 STX-R         | 02-05     | 1176 | 3    | 837728             | 172.95 | L | 837782                      | 214.95 | L | 837823       | 26.95 | L |

- accessories
- towables
- body
- controls
- electrical
- driveline
- engine**
- fuel & intake
- chemicals
- tie downs
- tools
- towing & loading

# MARINE

# ENGINE

## WINDEROSA PERSONAL WATERCRAFT GASKET SETS CONTINUED

| APPLICATION                             | YEAR  | CC   | CYL. | TOP END GASKET SET |        |   | COMPLETE SET WITH OIL SEALS |        |   | OIL SEAL SET |       |   |
|---|-------|------|------|--------------------|--------|---|-----------------------------|--------|---|--------------|-------|---|
| <b>POLARIS™</b>                         |       |      |      |                    |        |   |                             |        |   |              |       |   |
| SL650                                   | 92-95 | 650  | 3    | 837744             | 56.95  | L | 837796                      | 83.95  | L | 837827       | 17.95 | L |
| 700 HURRICANE, SL SLT, SLH, SLTH        | 96-00 | 700  | 2    | 837747             | 43.95  | L | 837799                      | 62.95  | L | 837828       | 12.95 | L |
| 700 FREEDOM, SLH                        | 01-04 | 700  | 2    | 837754             | 72.95  | L | 837806                      | 109.95 | L | 837829       | 28.95 | L |
| SL, SLT750                              | 93-95 | 750  | 3    | 837745             | 56.95  | L | 837797                      | 83.95  | L | 837827       | 17.95 | L |
| OCTANE 777- STAND UP                    | 02-04 | 777  | 2    | 837750             | 43.95  | L | 837802                      | 90.95  | L | 837829       | 28.95 | L |
| VIRAGE I                                | 02-04 | 777  | 2    | 837751             | 43.95  | L | 837803                      | 90.95  | L | 837829       | 28.95 | L |
| SL,SLT,SLX 780                          | 95-97 | 783  | 3    | 837746             | 82.95  | L | 837798                      | 102.95 | L | 837827       | 17.95 | L |
| SLX PRO 785                             | 97-00 | 779  | 3    | 837753             | 129.95 | L | 837805                      | 156.95 | L | 837827       | 17.95 | L |
| SL 900                                  | 96-97 | 889  | 3    | 837748             | 59.95  | L | 837800                      | 75.95  | L | 837828       | 12.95 | L |
| SL, SLTX, SLXH, SLX 1050                | 96-99 | 1051 | 3    | 837749             | 59.95  | L | 837801                      | 75.95  | L | 837828       | 12.95 | L |
| 1200 POLARIS (EARLY VERSION)            | 99-00 | 1165 | 3    | 837752             | 62.95  | L | 837804                      | 82.95  | L | 837828       | 12.95 | L |
| 1200 POLARIS (LATE VERSION)             | 01-04 | 1165 | 3    | 837755             | 110.95 | L | -----                       |        |   | 837829       | 28.95 | L |
| <b>SEA DOO™</b>                         |       |      |      |                    |        |   |                             |        |   |              |       |   |
| 580 (YELLOW ENGINE)                     | 88-91 | 580  | 2    | 837710             | 56.95  | L | 837761                      | 100.95 | L | 837817       | 16.95 | L |
| 580 (WHITE ENGINE)                      | 92-96 | 580  | 2    | 837714             | 56.95  | L | 837765                      | 81.95  | L | 837817       | 16.95 | L |
| 650                                     | 93-95 | 633  | 2    | 837715             | 56.95  | L | 837766                      | 79.95  | L | 837817       | 16.95 | L |
| 720                                     | 95-04 | 718  | 2    | 837716             | 56.95  | L | 837767                      | 81.95  | L | 837817       | 16.95 | L |
| 800 CARB                                | 95-99 | 782  | 2    | 837717             | 60.95  | L | 837768                      | 92.95  | L | 837818       | 16.95 | L |
| 800 RFI                                 | 00-05 | 782  | 2    | 837720             | 78.95  | L | 837770                      | 136.95 | L | 837818       | 16.95 | L |
| 951 (NOT 1997) CARB WHITE               | 98-00 | 951  | 2    | 837718             | 86.95  | L | 837769                      | 134.95 | L | 837819       | 11.95 | L |
| 951 CARB SILVER                         | 01-02 | 951  | 2    | 837722             | 144.95 | L | 837772                      | 158.95 | L | 837819       | 11.95 | L |
| 951 DI                                  | 00-07 | 951  | 2    | 837721             | 144.95 | L | 837771                      | 158.95 | L | 837819       | 11.95 | L |
| 4-TEC 1503 (EXCEPT 04 RXP SUPERCHARGED) | 02-04 | 1503 | 3    | -----              |        |   | 837773                      | 277.95 | L | -----        |       |   |
| 4-TEC 1503                              | 06-11 | 1503 | 3    | -----              |        |   | 837774                      | 277.95 | L | -----        |       |   |
| <b>WET JET™</b>                         |       |      |      |                    |        |   |                             |        |   |              |       |   |
| 440                                     |       | 436  | 2    | -----              |        |   | -----                       |        |   | 837816       | 9.95  | L |
| <b>YAMAHA™</b>                          |       |      |      |                    |        |   |                             |        |   |              |       |   |
| 500                                     | 87-93 | 524  | 2    | 837711             | 54.95  | L | 837762                      | 72.95  | L | 837812       | 14.95 | L |
| 650                                     | 90-96 | 633  | 2    | 837712             | 41.95  | L | 837763                      | 71.95  | L | 837813       | 14.95 | L |
| 700 WAVE BLASTER                        | 93-95 | 701  | 2    | 837736             | 41.95  | L | 837788                      | 71.95  | L | 837813       | 14.95 | L |
| WAVE RUNNER                             | 93-97 | 701  | 2    | 837736             | 41.95  | L | 837788                      | 71.95  | L | 837813       | 14.95 | L |
| SUPER JET                               | 94-95 | 701  | 2    | 837736             | 41.95  | L | 837788                      | 71.95  | L | 837813       | 14.95 | L |
| WAVE RAIDER                             | 96-98 | 701  | 2    | 837736             | 41.95  | L | 837788                      | 71.95  | L | 837813       | 14.95 | L |
| FX1                                     | 94-95 | 701  | 2    | 837736             | 41.95  | L | 837788                      | 71.95  | L | 837813       | 14.95 | L |
| 700 61X SUPER JET                       | 96-04 | 701  | 2    | 837740             | 44.95  | L | 837792                      | 71.95  | L | 837813       | 14.95 | L |
| WAVE BLASTER                            | 96    | 701  | 2    | 837740             | 44.95  | L | 837792                      | 71.95  | L | 837813       | 14.95 | L |
| 7001 62T WAVE RAIDER                    | 94-95 | 701  | 2    | 837737             | 44.95  | L | 837789                      | 71.95  | L | 837813       | 14.95 | L |
| WAVE VENTURE                            | 95-98 | 701  | 2    | 837737             | 44.95  | L | 837789                      | 71.95  | L | 837813       | 14.95 | L |
| WAVE RUNNER                             | 99-02 | 701  | 2    | 837737             | 44.95  | L | 837789                      | 71.95  | L | 837813       | 14.95 | L |
| 760 ALL 760                             | 96-00 | 760  | 2    | 837738             | 54.95  | L | 837790                      | 88.95  | L | 837813       | 14.95 | L |
| 800 GP800,XL800                         | 98-05 | 784  | 2    | 837742             | 82.95  | L | 837794                      | 116.95 | L | 837814       | 17.95 | L |
| 1100 WAVE RAIDER 1100                   | 95-97 | 1150 | 3    | 837739             | 77.95  | L | 837791                      | 131.95 | L | 837813       | 14.95 | L |
| 1100 WAVE VENTURE 1100                  | 96-97 | 1150 | 3    | 837739             | 77.95  | L | 837791                      | 131.95 | L | 837813       | 14.95 | L |
| 1200YAMAHA 1200                         | 97-04 | 1131 | 3    | 837741             | 80.95  | L | 837793                      | 131.95 | L | 837813       | 14.95 | L |
| 1200 POWER VALVE ENG.                   | 99-05 | 1176 | 3    | 837743             | 156.95 | L | 837795                      | 211.95 | L | 837815       | 17.95 | L |

MARINE



## PWC OIL SEAL SETS

Made from the highest quality materials available. Comes with all seals necessary to rebuild the engine.

| APPLICATION  | YEAR                             | QTY | OEM # (QTY)                            | OIL SEAL SET          |
|--|----------------------------------|-----|--|-----------------------|
| <b>ARCTCO™</b>   |                                  |     |  |                       |
| Tigershark 640   | 93-99                            | 3   | 3008-031<br>3008-032<br>3008-033       | <b>837824 17.95 L</b> |
| Tigershark 900<br>Tigershark 1000<br>Tigershark 1100R      | 95-96,<br>99<br>97-98<br>99      | 2   | 3004-522<br>3004-523                   | <b>837825 13.95 L</b> |
| <b>KAWASAKI™</b>   |                                  |     |  |                       |
| JS300 Jet Ski  | 86-91                            | 2   | 92049-1047 (2)                         | <b>837808 9.95 L</b>  |
| JS440 Jet Ski<br>JS550 Jet Ski                             | 82-92<br>82-95                   | 3   | 92049-3005<br>92050-507<br>92049-3006  | <b>837809 14.95 L</b> |
| JS650 Jet Ski<br>JS750 Jet Ski<br>JS800 Jet Ski            | 86-96<br>92-02<br>03-05          | 3   | 92049-3705 (2)<br>92049-3706           | <b>837810 14.95 L</b> |
| JH900 JT 900<br>JH1100, JT1100<br>Ultra 130                | 95-05<br>96-04<br>04             | 3   | 92049-3715<br>92049-3716<br>92049-3713 | <b>837821 19.95 L</b> |
| Ultra 150  | 99                               | 3   | 92049-3728<br>92049-3725<br>92049-3729 | <b>837822 26.95 L</b> |
| Ultra 150  | 00-04                            | 3   | 92049-3728<br>92049-3725<br>92049-3730 | <b>837823 26.95 L</b> |
| <b>POLARIS™</b>  |                                  |     |  |                       |
| Polaris 650<br>Polaris 750<br>Polaris 780<br>Polaris 785   | 92-95<br>93-95<br>95-97<br>97-00 | 3   | 3240042<br>3240043<br>3240041          | <b>837827 17.95 L</b> |
| Polaris 700<br>Polaris 900<br>Polaris 1050<br>Polaris 1200 | 96-00<br>96-97<br>96-99<br>99-00 | 2   | 3610-044<br>5410-913                   | <b>837828 12.95 L</b> |



| APPLICATION  | YEAR                                      | QTY | OEM # (QTY)                               | OIL SEAL SET          |
|--|---|-----|---|-----------------------|
| <b>POLARIS™ CONTINUED</b>  |   |     |   |                       |
| Polaris 700<br>Polaris 777<br>Polaris 1200                           | 01-04<br>02-04<br>01-04                   | 3   | 3610-44<br>5411                           | <b>837829 28.95 L</b> |
| <b>SEA-DOO™</b>  |   |     |   |                       |
| Sea Doo 580<br>Sea Doo 650<br>Sea Doo 720                            | 89-96<br>93-95<br>95-00                   | 3   | 290-830-749<br>290-831-952<br>290-930-580 | <b>837817 16.95 L</b> |
| Sea Doo 800  | 95-99                                     | 3   | 290-830-749<br>290-830-638<br>290-930-580 | <b>837818 16.95 L</b> |
| Sea Doo 951  | 98-00<br>(not<br>97)                      | 2   | Crankshaft O.S.                           | <b>837819 11.95 L</b> |
| Sea Doo 800, 951   | 98-00                                     | 2   | Counter<br>Balance O.S.                   | <b>837820 5.95 L</b>  |
| <b>YAMAHA™</b>   |   |     |   |                       |
| Yamaha 500   | 87-93                                     | 3   | 93102-25M11<br>93101-25M35<br>93101-25M38 | <b>837812 14.95 L</b> |
| Yamaha 650<br>Yamaha 701<br>Yamaha 760<br>Yamaha 1100<br>Yamaha 1200 | 90-96<br>93-04<br>96-00<br>95-97<br>97-04 | 3   | 93102-36M33<br>93101-36M46<br>93103-32M01 | <b>837813 14.95 L</b> |
| Yamaha 800   | 98-05                                     | 3   | 93103-36M62<br>93101-36M61<br>93103-35M03 | <b>837814 17.95 L</b> |
| Yamaha 1200R<br>Power Valve Eng.                                     | 98-05                                     | 3   | 93103-36M62<br>93101-36M61<br>93102-35M57 | <b>837815 17.95 L</b> |

All use of OEM names and numbers are for identification purposes only.

## MOTION PRO OIL FILTER MAGNETS



- Easy to install, just attach to base of standard oil filter
- Standard oil filters only trap particles down to 20 microns, leaving the most harmful 5 to 20 micron particles to circulate through your engine
- This powerful six point magnet traps harmful, abrasive hard metal particles down to 1 micron that regular oil filters don't
- Must have item during engine break in
- No gimmick, these things really work to reduce wear, and significantly increase engine life
- Available in two sizes to fit most spin on or cartridge oil filters
- Makes any oil filter better than a high performance oil filter
- Reusable for up to 5 oil filter changes

| APPLICATION      | CC   | TYPE | YEAR  | PART #               |
|------------------|------|------|-------|----------------------|
| <b>KAWASAKI</b>  |      |      |       |                      |
| JT 1200D STX-12F | 1200 | PWC  | 06-07 | <b>142543 5.99 E</b> |
| JT 1500A STX-15F | 1500 | PWC  | 06-11 | <b>142543 5.99 E</b> |



- accessories
- towables
- body
- controls
- electrical
- driveline
- engine**
- fuel & intake
- chemicals
- tie downs
- tools
- towing & loading

# MARINE



## MOTOR MOUNTS

Replacement for broken or worn-out OEM motor mounts.

accessories

towables

body

controls

electrical

driveline

**engine**

fuel & intake

chemicals

tie downs

tools



| MODEL           | CC        | YEAR   | PART #        |                |
|-----------------|-----------|--------|---------------|----------------|
| <b>HONDA</b>    |           |        |               |                |
| ARX             | 1200/1500 | 08-'09 | <b>329102</b> | <b>66.72 L</b> |
| <b>KAWASAKI</b> |           |        |               |                |
| JS              | 400       | 76     | <b>328677</b> | <b>30.70 L</b> |
| JS              | 440       | 77-86  | <b>328677</b> | <b>30.70 L</b> |
| JS              | 550       | 82-86  | <b>328677</b> | <b>30.70 L</b> |
| XIR             | 750       | 94     | <b>328677</b> | <b>30.70 L</b> |
| SC              | 650       | 91-95  | <b>328678</b> | <b>41.25 L</b> |
| SX              | 650       | 87-93  | <b>328678</b> | <b>41.25 L</b> |
| TS              | 650       | 89-96  | <b>328678</b> | <b>41.25 L</b> |
| X2              | 650       | 86-95  | <b>328678</b> | <b>41.25 L</b> |
| SS              | 750       | 92-97  | <b>328678</b> | <b>41.25 L</b> |
| SUPER SPORT XI  | 750       | 93-97  | <b>328678</b> | <b>41.25 L</b> |
| SX              | 750       | 92-95  | <b>328678</b> | <b>41.25 L</b> |
| SXI             | 750       | 95-97  | <b>328678</b> | <b>41.25 L</b> |
| XI SPORT        | 750       | 98-99  | <b>328678</b> | <b>41.25 L</b> |
| Jet Mate        | 800       | 91-92  | <b>328678</b> | <b>41.25 L</b> |
| SXI Pro         | 800       | 98-'02 | <b>328678</b> | <b>41.25 L</b> |
| SX-R            | 800       | 03-'11 | <b>328678</b> | <b>41.25 L</b> |
| STX-R           | 1200      | 02-'05 | <b>328675</b> | <b>42.00 L</b> |
| ULTRA 150       | 1200      | 99-'05 | <b>328675</b> | <b>42.00 L</b> |
| STS             | 900       | 01-'03 | <b>328676</b> | <b>36.75 L</b> |
| STX             | 900       | 97-'06 | <b>328676</b> | <b>36.75 L</b> |
| ZXI             | 900       | 95-97  | <b>328676</b> | <b>36.75 L</b> |
| STX             | 1100      | 97-99  | <b>328676</b> | <b>36.75 L</b> |
| STX DI          | 1100      | 00-'03 | <b>328676</b> | <b>36.75 L</b> |
| ZXI             | 1100      | 96-'03 | <b>328676</b> | <b>36.75 L</b> |

| MODEL                     | CC   | YEAR   | PART #        |                |
|---------------------------|------|--------|---------------|----------------|
| <b>KAWASAKI CONTINUED</b> |      |        |               |                |
| STX-12F                   | 1200 | 03-'07 | <b>328676</b> | <b>36.75 L</b> |
| STX-R                     | 1200 | 02-'05 | <b>328676</b> | <b>36.75 L</b> |
| ULTRA 150                 | 1200 | 99-'05 | <b>328676</b> | <b>36.75 L</b> |
| STX                       | 1500 | 09-'10 | <b>328676</b> | <b>36.75 L</b> |
| STX-12F                   | 1500 | 04-'09 | <b>328676</b> | <b>36.75 L</b> |
| ULTRA 250X                | 1500 | 07-'08 | <b>328676</b> | <b>36.75 L</b> |
| ULTRA 260 LX              | 1500 | 09-'10 | <b>328676</b> | <b>36.75 L</b> |
| ULTRA 260X                | 1500 | 09-'10 | <b>328676</b> | <b>36.75 L</b> |
| ULTRA LX                  | 1500 | 07-'12 | <b>328676</b> | <b>36.75 L</b> |
| ULTRA 300 All             | 1500 | 11-'13 | <b>328676</b> | <b>36.75 L</b> |
| ULTRA 310 All             | 1500 | 14-'15 | <b>328676</b> | <b>36.75 L</b> |
| <b>POLARIS</b>            |      |        |               |                |
| SL                        | 650  | 92-95  | <b>328682</b> | <b>48.45 L</b> |
| SL                        | 750  | 93-95  | <b>328682</b> | <b>48.45 L</b> |
| SL                        | 780  | 96-97  | <b>328682</b> | <b>48.45 L</b> |
| SLT                       | 780  | 96-97  | <b>328682</b> | <b>48.45 L</b> |
| SLX                       | 780  | 95-96  | <b>328682</b> | <b>48.45 L</b> |
| VIRAGE                    | 700  | 00-'02 | <b>328682</b> | <b>48.45 L</b> |
| SLH                       | 700  | 98-'01 | <b>328688</b> | <b>42.00 L</b> |
| SL                        | 900  | 96-97  | <b>328688</b> | <b>42.00 L</b> |
| SLTX                      | 1050 | 96-99  | <b>328688</b> | <b>42.00 L</b> |
| SLX                       | 1050 | 99     | <b>328688</b> | <b>42.00 L</b> |
| GENISIS                   | 1200 | 99-'04 | <b>328688</b> | <b>42.00 L</b> |
| SLX                       | 1200 | 00-'01 | <b>328688</b> | <b>42.00 L</b> |
| VIRAGE TX                 | 1200 | 00-'02 | <b>328688</b> | <b>42.00 L</b> |
| OCTANE                    | 777  | 02-'04 | <b>328689</b> | <b>70.10 L</b> |

MARINE

## WSM MOTOR MOUNTS CONTINUED

| MODEL                  | CC   | YEAR   | PART #        |                |
|------------------------|------|--------|---------------|----------------|
| <b>SEA-DOO</b>         |      |        |               |                |
| GT                     | 580  | 90-91  | <b>328679</b> | <b>27.05</b> L |
| GTS                    | 580  | 92-96  | <b>328679</b> | <b>27.05</b> L |
| GTX                    | 580  | 92-93  | <b>328679</b> | <b>27.05</b> L |
| SP                     | 580  | 89-96  | <b>328679</b> | <b>27.05</b> L |
| SPI                    | 580  | 93-96  | <b>328679</b> | <b>27.05</b> L |
| SPX                    | 580  | 93     | <b>328679</b> | <b>27.05</b> L |
| XP                     | 580  | 91-92  | <b>328679</b> | <b>27.05</b> L |
| GTX                    | 650  | 94-95  | <b>328679</b> | <b>27.05</b> L |
| SPX                    | 650  | 94-95  | <b>328679</b> | <b>27.05</b> L |
| XP                     | 650  | 93-95  | <b>328679</b> | <b>27.05</b> L |
| XPI                    | 650  | 94     | <b>328679</b> | <b>27.05</b> L |
| GS                     | 720  | 97-'01 | <b>328679</b> | <b>27.05</b> L |
| GSI                    | 720  | 97     | <b>328679</b> | <b>27.05</b> L |
| GTI                    | 720  | 96-'05 | <b>328679</b> | <b>27.05</b> L |
| GTI LE                 | 720  | 02-'04 | <b>328679</b> | <b>27.05</b> L |
| GTS                    | 720  | 97-'01 | <b>328679</b> | <b>27.05</b> L |
| HX                     | 720  | 95-97  | <b>328679</b> | <b>27.05</b> L |
| SP                     | 720  | 97     | <b>328681</b> | <b>36.85</b> L |
| GSX                    | 800  | 96-98  | <b>328681</b> | <b>36.85</b> L |
| GSX RFI                | 800  | 99-'00 | <b>328681</b> | <b>36.85</b> L |
| GTI LE RFI             | 800  | 03     | <b>328681</b> | <b>36.85</b> L |
| GTX                    | 800  | 96-97  | <b>328681</b> | <b>36.85</b> L |
| GTX RFI                | 800  | 98-'02 | <b>328681</b> | <b>36.85</b> L |
| SPX                    | 800  | 97-99  | <b>328681</b> | <b>36.85</b> L |
| XP                     | 800  | 95-97  | <b>328681</b> | <b>36.85</b> L |
| GSX<br>(98 Production) | 951  | 98     | <b>328681</b> | <b>36.85</b> L |
| GSX Ltd                | 951  | 98-99  | <b>328681</b> | <b>36.85</b> L |
| GTX                    | 951  | 00-'02 | <b>328681</b> | <b>36.85</b> L |
| GTX DI                 | 951  | 00-'03 | <b>328681</b> | <b>36.85</b> L |
| GTX Ltd                | 951  | 98-99  | <b>328681</b> | <b>36.85</b> L |
| LRV                    | 951  | 00-'02 | <b>328681</b> | <b>36.85</b> L |
| RX                     | 951  | 00-'02 | <b>328681</b> | <b>36.85</b> L |
| RX DI                  | 951  | 00-'03 | <b>328681</b> | <b>36.85</b> L |
| RX X                   | 951  | 01     | <b>328681</b> | <b>36.85</b> L |
| XP                     | 951  | 00-'02 | <b>328681</b> | <b>36.85</b> L |
| XP DI                  | 951  | 03-'04 | <b>328681</b> | <b>36.85</b> L |
| XP Ltd                 | 951  | 98-99  | <b>328681</b> | <b>36.85</b> L |
| GTI LE RFI             | 800  | 03-'05 | <b>328697</b> | <b>46.70</b> L |
| GTX RFI                | 800  | 98-'02 | <b>328697</b> | <b>46.70</b> L |
| XP                     | 951  | 00-'02 | <b>328697</b> | <b>46.70</b> L |
| XP DI                  | 951  | 03-'04 | <b>328697</b> | <b>46.70</b> L |
| XP LTD.                | 951  | 98-99  | <b>328697</b> | <b>46.70</b> L |
| 3D RFI                 | 800  | 04-'05 | <b>328696</b> | <b>43.75</b> L |
| GTI RFI                | 800  | 03-'05 | <b>328696</b> | <b>43.75</b> L |
| SPX                    | 800  | 97-99  | <b>328680</b> | <b>42.60</b> L |
| GSX                    | 951  | 97-99  | <b>328680</b> | <b>42.60</b> L |
| GTX                    | 951  | 99-'03 | <b>328680</b> | <b>42.60</b> L |
| LRV                    | 951  | 00-'02 | <b>328680</b> | <b>42.60</b> L |
| RX                     | 951  | 00-'03 | <b>328680</b> | <b>42.60</b> L |
| GTI RFI, LE            | 800  | 03-'05 | <b>328694</b> | <b>46.70</b> L |
| GTX 4-TEC              | 1503 | 04     | <b>328694</b> | <b>46.70</b> L |
| GTI 135, 155           | 1503 | 08-'14 | <b>328694</b> | <b>46.70</b> L |
| GTX 155, 215           | 1503 | 08-'14 | <b>328694</b> | <b>46.70</b> L |
| RXP 155; 215, 255      | 1503 | 08-'12 | <b>328694</b> | <b>46.70</b> L |
| RXT 215, 255           | 1503 | 08-'12 | <b>328694</b> | <b>46.70</b> L |

| MODEL                    | CC   | YEAR   | PART #        |                |
|--------------------------|------|--------|---------------|----------------|
| <b>SEA-DOO CONTINUED</b> |      |        |               |                |
| WAKE 155, 215            | 1503 | 08-'14 | <b>328694</b> | <b>46.70</b> L |
| GTI 4-TEC All Models     | 1503 | 06-'14 | <b>328695</b> | <b>43.75</b> L |
| GTX 4-TEC All Models     | 1503 | 02-'12 | <b>328695</b> | <b>43.75</b> L |
| RXP All Models           | 1503 | 04-'14 | <b>328695</b> | <b>43.75</b> L |
| RXT All Models           | 1503 | 05-'12 | <b>328695</b> | <b>43.75</b> L |
| Wake All Models          | 1503 | 08-'12 | <b>328695</b> | <b>43.75</b> L |
| <b>TIGER SHARK</b>       |      |        |               |                |
| ALL MODELS               | 640  | 93-99  | <b>328690</b> | <b>41.25</b> L |
| <b>YAMAHA</b>            |      |        |               |                |
| Super Jet                | 650  | 90-93  | <b>328685</b> | <b>36.85</b> L |
| Super Jet                | 700  | 95-'15 | <b>328685</b> | <b>36.85</b> L |
| FX1                      | 700  | 94-95  | <b>328686</b> | <b>40.10</b> L |
| Wave Blaster             | 700  | 93-96  | <b>328686</b> | <b>40.10</b> L |
| Wave Blaster             | 760  | 96-97  | <b>328686</b> | <b>40.10</b> L |
| GP                       | 800  | 01-'05 | <b>328692</b> | <b>50.80</b> L |
| VXR                      | 650  | 91-95  | <b>328687</b> | <b>40.10</b> L |
| Wave Runner III          | 650  | 90-96  | <b>328687</b> | <b>40.10</b> L |
| Wave Runner LX           | 650  | 91-92  | <b>328687</b> | <b>40.10</b> L |
| VXR Pro                  | 700  | 93-94  | <b>328687</b> | <b>40.10</b> L |
| Wave Raider              | 700  | 94-97  | <b>328687</b> | <b>40.10</b> L |
| Wave Runner III          | 700  | 94-97  | <b>328687</b> | <b>40.10</b> L |
| Wave Venture             | 700  | 95     | <b>328687</b> | <b>40.10</b> L |
| Wave Venture             | 700  | 98     | <b>328687</b> | <b>40.10</b> L |
| XL                       | 700  | 99-'04 | <b>328687</b> | <b>40.10</b> L |
| GP                       | 760  | 99-'00 | <b>328687</b> | <b>40.10</b> L |
| Wave Raider              | 760  | 96     | <b>328687</b> | <b>40.10</b> L |
| Wave Runner              | 760  | 97-98  | <b>328687</b> | <b>40.10</b> L |
| Wave Venture             | 760  | 97     | <b>328687</b> | <b>40.10</b> L |
| XL                       | 760  | 98-99  | <b>328687</b> | <b>40.10</b> L |
| GP                       | 800  | 98-99  | <b>328687</b> | <b>40.10</b> L |
| XL                       | 800  | 00-'03 | <b>328687</b> | <b>40.10</b> L |
| XLT                      | 800  | 02-'04 | <b>328687</b> | <b>40.10</b> L |
| Wave Raider              | 1100 | 95-96  | <b>328687</b> | <b>40.10</b> L |
| Wave Venture             | 1100 | 96-97  | <b>328687</b> | <b>40.10</b> L |
| GP                       | 1200 | 97-99  | <b>328687</b> | <b>40.10</b> L |
| SUV                      | 1200 | 99-'01 | <b>328687</b> | <b>40.10</b> L |
| SUV                      | 1200 | 03-'04 | <b>328687</b> | <b>40.10</b> L |
| SV                       | 1200 | 02     | <b>328687</b> | <b>40.10</b> L |
| XL                       | 1200 | 98     | <b>328687</b> | <b>40.10</b> L |
| XL                       | 1200 | 99-'01 | <b>328691</b> | <b>47.85</b> L |
| XLT                      | 1200 | 02-'05 | <b>328691</b> | <b>47.85</b> L |
| FX 140                   | 1000 | 02-'06 | <b>328692</b> | <b>50.80</b> L |
| FX Cruiser               | 1000 | 03-'15 | <b>328692</b> | <b>50.80</b> L |
| FX High Output           | 1100 | 04-'06 | <b>328692</b> | <b>50.80</b> L |
| VX                       | 1100 | 05-'15 | <b>328692</b> | <b>50.80</b> L |
| V1 / V1 Sport            | 1100 | 15     | <b>328692</b> | <b>50.80</b> L |
| GP R                     | 1200 | 00-'01 | <b>328692</b> | <b>50.80</b> L |
| GP                       | 1300 | 04-'08 | <b>328692</b> | <b>50.80</b> L |
| FZR                      | 1800 | 09-'15 | <b>328692</b> | <b>50.80</b> L |
| FZS                      | 1800 | 09-'15 | <b>328692</b> | <b>50.80</b> L |
| VXR                      | 1800 | 11-'14 | <b>328692</b> | <b>50.80</b> L |
| VXS                      | 1800 | 11-'14 | <b>328692</b> | <b>50.80</b> L |

accessories

towables

body

controls

electrical

driveline

engine

fuel &amp; intake

chemicals

tie downs

tools

towing &amp; loading

MARINE

# ENGINE

## K&N WRENCH OFF MARINE OIL FILTERS

### What makes K&N oil filters better?

The **K&N Premium Wrench-Off Oil Filter** has been constructed from the ground up to satisfy the high performance needs of marine applications, as well as the average boat who wants the very best oil filter available. Our oil filter has a high efficiency rating for outstanding filtration. A 1" nut on the end of the filter provides for easy removal. This nut is drilled through to allow the use of a safety wire; great for off shore or rough water.

We use metal top end caps instead of paper to ensure that no unfiltered oil can get back into the system. They are covered by a limited warranty to be free from defects in materials and workmanship when installed and replaced using engine and equipment manufacturers recommended service interval.

- Premium canister oil filters for marine applications
- Exposed nut designed for easy removal (where applicable)
- Heavy duty construction, high flow rates, & outstanding oil filtration
- Traps 99% of harmful contaminants
- Can be used with the latest synthetic motor oils



| CC           | MODEL                          | YEAR  | STANDARD             | CHROME                |
|--------------|--------------------------------|-------|----------------------|-----------------------|
| <b>HONDA</b> |                                |       |                      |                       |
| 1235         | ARX1200N2 AQUATRAX R-12        | 04-06 | <b>KN204</b> 15.49 G | <b>KN204C</b> 18.79 G |
| 1235         | ARX1200N3 AQUATRAX F-12        | 02-07 | <b>KN204</b> 15.49 G | <b>KN204C</b> 18.79 G |
| 1235         | ARX1200T2 AQUATRAX R-12X       | 03-07 | <b>KN204</b> 15.49 G | <b>KN204C</b> 18.79 G |
| 1235         | ARX1200T3 AQUATRAX F-12X       | 02-07 | <b>KN204</b> 15.49 G | <b>KN204C</b> 18.79 G |
| 1235         | ARX1200T3D AQUATRAX F-12X GPSC | 05-07 | <b>KN204</b> 15.49 G | <b>KN204C</b> 18.79 G |
| 1470         | ARX1500N3 AQUATRAX F-15        | 09    | <b>KN204</b> 15.49 G | <b>KN204C</b> 18.79 G |
| 1470         | ARX1500T3 AQUATRAX F-15X       | 08-09 | <b>KN204</b> 15.49 G | <b>KN204C</b> 18.79 G |
| 1470         | ARX1500T3D AQUATRAX F-15X GPSC | 08    | <b>KN204</b> 15.49 G | <b>KN204C</b> 18.79 G |

| CC              | MODEL                | YEAR  | STANDARD             | CHROME                |
|-----------------|----------------------|-------|----------------------|-----------------------|
| <b>KAWASAKI</b> |                      |       |                      |                       |
| 1176            | JT1200 STX-12F       | 03-06 | <b>KN204</b> 15.49 G | <b>KN204C</b> 18.79 G |
| 1176            | JT1200 STX-12F       | 07    | <b>KN303</b> 15.49 G | <b>KN303C</b> 19.89 G |
| 1493            | JT1500 STX-15F       | 04-09 | <b>KN204</b> 15.49 G | <b>KN204C</b> 18.79 G |
| 1493            | JT1500 STX-15F       | 07-09 | <b>KN303</b> 15.49 G | <b>KN303C</b> 19.89 G |
| 1500            | JT1500 STX           | 09    | <b>KN204</b> 15.49 G | <b>KN204C</b> 18.79 G |
| 1500            | JT1500 STX           | 10    | <b>KN204</b> 15.49 G | <b>KN204C</b> 18.79 G |
| 1500            | JT1500 STX-15F       | 10-11 | <b>KN204</b> 15.49 G | <b>KN204C</b> 18.79 G |
| 1500            | JT1500 ULTRA 300 LX  | 13    | <b>KN204</b> 15.49 G | <b>KN204C</b> 18.79 G |
| 1500            | JT1500 ULTRA 300 X   | 13    | <b>KN204</b> 15.49 G | <b>KN204C</b> 18.79 G |
| 1500            | JT1500 ULTRA 310LX   | 14    | <b>KN204</b> 15.49 G | <b>KN204C</b> 18.79 G |
| 1500            | JT1500 ULTRA 310R    | 14    | <b>KN204</b> 15.49 G | <b>KN204C</b> 18.79 G |
| 1500            | JT1500 ULTRA 310X    | 14    | <b>KN204</b> 15.49 G | <b>KN204C</b> 18.79 G |
| 1500            | JT1500 ULTRA 310X SE | 14    | <b>KN204</b> 15.49 G | <b>KN204C</b> 18.79 G |
| 1500            | JT1500 ULTRA LX      | 10-11 | <b>KN204</b> 15.49 G | <b>KN204C</b> 18.79 G |
| 1500            | JT1500 ULTRA LX      | 13-14 | <b>KN204</b> 15.49 G | <b>KN204C</b> 18.79 G |
| 1500            | ULTRA 300 LX         | 11-12 | <b>KN204</b> 15.49 G | <b>KN204C</b> 18.79 G |
| 1500            | ULTRA 300 X          | 11-12 | <b>KN204</b> 15.49 G | <b>KN204C</b> 18.79 G |
| 1500            | JT1500 STX-15F       | 13-14 | <b>KN204</b> 15.49 G | <b>KN204C</b> 18.79 G |
| 1500            | JT1500 ULTRA 250X    | 07-08 | <b>KN204</b> 15.49 G | <b>KN204C</b> 18.79 G |
| 1500            | JT1500 ULTRA 260 LX  | 09-10 | <b>KN204</b> 15.49 G | <b>KN204C</b> 18.79 G |
| 1500            | JT1500 ULTRA 260 X   | 09-10 | <b>KN204</b> 15.49 G | <b>KN204C</b> 18.79 G |
| 1500            | JT1500 ULTRA LX      | 07-09 | <b>KN204</b> 15.49 G | <b>KN204C</b> 18.79 G |

- accessories
- towables
- body
- controls
- electrical
- driveline
- engine
- fuel & intake
- chemicals
- tie downs
- tools
- towing & loading

MARINE



## K&amp;N OIL FILTERS CONTINUED

| CC             | MODEL                 | YEAR  | STANDARD        | CHROME |
|----------------|-----------------------|-------|-----------------|--------|
| <b>SEA-DOO</b> |                       |       |                 |        |
| 1484           | GTX 4-TEC             | 02-03 | KN556 14.89 G   | ----   |
| 1484           | GTX 4-TEC             | 03-04 | KN556 14.89 G   | ----   |
| 1484           | GTX 4-TEC             | 03    | KN556 14.89 G   | ----   |
| 1484           | GTX 4-TEC             | 04    | KN556 14.89 G   | ----   |
| 1494           | 150 SPEEDSTER 155HP   | 09    | KN556 14.89 G   | ----   |
| 1494           | 150 SPEEDSTER 215HP   | 09    | KN556 14.89 G   | ----   |
| 1494           | 150 SPEEDSTER 255HP   | 09    | KN556 14.89 G   | ----   |
| 1494           | 180 C                 | 09    | KN556 14.89 G   | ----   |
| 1494           | 180 C                 | 09    | KN556 14.89 G   | ----   |
| 1494           | 180 C                 | 09    | KN556 14.89 G   | ----   |
| 1494           | 200 SPEEDSTER 430HP   | 09    | * KN556 14.89 G | ----   |
| 1494           | 205 UTOPIA SE 310HP   | 09    | * KN556 14.89 G | ----   |
| 1494           | 205 UTOPIA SE 430HP   | 09    | * KN556 14.89 G | ----   |
| 1494           | 230 C                 | 07-08 | KN556 14.89 G   | ----   |
| 1494           | 230 C                 | 07-08 | KN556 14.89 G   | ----   |
| 1494           | 230 WAKE              | 07-08 | KN556 14.89 G   | ----   |
| 1494           | 230 WAKE ENG 2        | 07-08 | KN556 14.89 G   | ----   |
| 1494           | GTI 130               | 08-13 | KN556 14.89 G   | ----   |
| 1494           | GTI SE                | 06-07 | KN556 14.89 G   | ----   |
| 1494           | GTI SE 130            | 08-13 | KN556 14.89 G   | ----   |
| 1494           | GTI SE 155            | 08-13 | KN556 14.89 G   | ----   |
| 1494           | GTI STD               | 06-07 | KN556 14.89 G   | ----   |
| 1494           | GTX                   | 05-06 | KN556 14.89 G   | ----   |
| 1494           | GTX 155               | 08-13 | KN556 14.89 G   | ----   |
| 1494           | GTX 215               | 08-09 | KN556 14.89 G   | ----   |
| 1494           | GTX 215               | 11-13 | KN556 14.89 G   | ----   |
| 1494           | GTX 4-TEC             | 04    | KN556 14.89 G   | ----   |
| 1494           | GTX 4-TEC             | 03-04 | KN556 14.89 G   | ----   |
| 1494           | GTX 4-TEC             | 05-06 | KN556 14.89 G   | ----   |
| 1494           | GTX 4-TEC             | 05-06 | KN556 14.89 G   | ----   |
| 1494           | GTX LIMITED           | 05-06 | KN556 14.89 G   | ----   |
| 1494           | GTX LIMITED           | 08    | KN556 14.89 G   | ----   |
| 1494           | GTX LIMITED IS 255    | 09    | KN556 14.89 G   | ----   |
| 1494           | GTX LTD BVIC          | 07    | KN556 14.89 G   | ----   |
| 1494           | GTX S 155             | 12-13 | KN556 14.89 G   | ----   |
| 1494           | GTX SC                | 05-06 | KN556 14.89 G   | ----   |
| 1494           | GTX STD               | 07    | KN556 14.89 G   | ----   |
| 1494           | GTX WAKE              | 07    | KN556 14.89 G   | ----   |
| 1494           | GTX WAKE BVIC         | 07    | KN556 14.89 G   | ----   |
| 1494           | ISLANDIA SE           | 07-08 | KN556 14.89 G   | ----   |
| 1494           | ISLANDIA SE ENG. 2    | 07-08 | KN556 14.89 G   | ----   |
| 1494           | RXP                   | 05-06 | KN556 14.89 G   | ----   |
| 1494           | RXP 155               | 08    | KN556 14.89 G   | ----   |
| 1494           | RXP 215               | 08-10 | KN556 14.89 G   | ----   |
| 1494           | RXP NA                | 07    | KN556 14.89 G   | ----   |
| 1494           | RXP SUPERC            | 04    | KN556 14.89 G   | ----   |
| 1494           | RXP-X 255             | 08-11 | KN556 14.89 G   | ----   |
| 1494           | RXP-X 260             | 12-13 | KN556 14.89 G   | ----   |
| 1494           | RXT                   | 05-06 | KN556 14.89 G   | ----   |
| 1494           | RXT 215               | 08-10 | KN556 14.89 G   | ----   |
| 1494           | RXT 260               | 11-13 | KN556 14.89 G   | ----   |
| 1494           | RXT BVIC              | 07    | KN556 14.89 G   | ----   |
| 1494           | RXT IS 255            | 09-12 | KN556 14.89 G   | ----   |
| 1494           | RXT X 260             | 10-13 | KN556 14.89 G   | ----   |
| 1494           | RXT X AS 260          | 11-13 | KN556 14.89 G   | ----   |
| 1494           | RXT-X 255             | 08-09 | KN556 14.89 G   | ----   |
| 1494           | SPEEDSTER WAKE        | 06-08 | KN556 14.89 G   | ----   |
| 1494           | SPEEDSTER WAKE 430HP  | 09    | * KN556 14.89 G | ----   |
| 1494           | SPEEDSTER WAKE ENG. 2 | 06-08 | KN556 14.89 G   | ----   |
| 1494           | SPORTSTER SC          | 05    | KN556 14.89 G   | ----   |
| 1494           | SPORTSTER SC          | 05    | KN556 14.89 G   | ----   |
| 1494           | WAKE                  | 05-06 | KN556 14.89 G   | ----   |
| 1494           | WAKE 155              | 07-13 | KN556 14.89 G   | ----   |
| 1494           | WAKE 215              | 08    | KN556 14.89 G   | ----   |
| 1494           | WAKE PRO 215          | 09-13 | KN556 14.89 G   | ----   |

accessories

towables

body

controls

electrical

driveline

engine

fuel &  
intake

chemicals

tie downs

tools

towing &  
loading

MARINE

## K&N OIL FILTERS CONTINUED

- accessories
- towables
- body
- controls
- electrical
- driveline
- engine**
- fuel & intake
- chemicals
- tie downs
- tools
- towing & loading

| CC            | MODEL                     | YEAR  | STANDARD      | CHROME         |
|---------------|---------------------------|-------|---------------|----------------|
| <b>YAMAHA</b> |                           |       |               |                |
| 998           | FAT1100 212SS             | 08-09 | KN204 15.49 G | KN204C 18.79 G |
| 998           | FAT1100 212SS ENG 2       | 08-09 | KN204 15.49 G | KN204C 18.79 G |
| 998           | FAT1100 212X ENG 1        | 08-09 | KN204 15.49 G | KN204C 18.79 G |
| 998           | FAT1100 212X ENG 2        | 08-09 | KN204 15.49 G | KN204C 18.79 G |
| 998           | FRT1100 AR210 ENG 1       | 06-07 | KN303 15.49 G | KN303C 19.89 G |
| 998           | FRT1100 AR210 ENG 1       | 08-09 | KN204 15.49 G | KN204C 18.79 G |
| 998           | FRT1100 AR210 ENG 2       | 06-07 | KN303 15.49 G | KN303C 19.89 G |
| 998           | FRT1100 AR210 ENG 2       | 08-09 | KN204 15.49 G | KN204C 18.79 G |
| 998           | FRT1100 SR210             | 06-07 | KN303 15.49 G | KN303C 19.89 G |
| 998           | FRT1100 SR210 ENG 2       | 06-07 | KN303 15.49 G | KN303C 19.89 G |
| 998           | FRT1100 SX210             | 06-07 | KN303 15.49 G | KN303C 19.89 G |
| 998           | FRT1100 SX210             | 08    | KN204 15.49 G | KN204C 18.79 G |
| 998           | FRT1100 SX210 ENG 2       | 06-07 | KN303 15.49 G | KN303C 19.89 G |
| 998           | FRT1100 SX210 ENG 2       | 08    | KN204 15.49 G | KN204C 18.79 G |
| 998           | FX1000 WAVERUNNER         | 05-06 | KN303 15.49 G | KN303C 19.89 G |
| 998           | FX1000 WAVERUNNER C       | 05-07 | KN303 15.49 G | KN303C 19.89 G |
| 998           | FX1000 WAVERUNNER C       | 08    | KN204 15.49 G | KN204C 18.79 G |
| 998           | FX1000 WAVERUNNER FX      | 07    | KN303 15.49 G | KN303C 19.89 G |
| 998           | FX1000 WAVERUNNER FX      | 08    | KN204 15.49 G | KN204C 18.79 G |
| 998           | FX1100 WAVERUNNER C       | 04-06 | KN303 15.49 G | KN303C 19.89 G |
| 998           | FX1100 WAVERUNNER FX C    | 07    | KN303 15.49 G | KN303C 19.89 G |
| 998           | FX1100 WAVERUNNER H.O.    | 04-06 | KN303 15.49 G | KN303C 19.89 G |
| 998           | FX1100 WAVERUNNER H.O.    | 08    | KN204 15.49 G | KN204C 18.79 G |
| 998           | SRT1000 AR230 ENG 1       | 04-05 | KN303 15.49 G | KN303C 19.89 G |
| 998           | SRT1000 AR230 ENG 2       | 04-05 | KN303 15.49 G | KN303C 19.89 G |
| 998           | SRT1000 SR230             | 03-05 | KN303 15.49 G | KN303C 19.89 G |
| 998           | SRT1000 SR230 ENG 2       | 03-05 | KN303 15.49 G | KN303C 19.89 G |
| 998           | SRT1000 SX230             | 04-05 | KN303 15.49 G | KN303C 19.89 G |
| 998           | SRT1000 SX230 ENG 2       | 04-05 | KN303 15.49 G | KN303C 19.89 G |
| 998           | SRT1100 AR230 H.O. ENG 1  | 05-06 | KN303 15.49 G | KN303C 19.89 G |
| 998           | SRT1100 AR230 H.O. ENG 2  | 05-06 | KN303 15.49 G | KN303C 19.89 G |
| 998           | SRT1100 SX230 H.O.        | 05-06 | KN303 15.49 G | KN303C 19.89 G |
| 998           | SRT1100 SX230 H.O. ENG 2  | 05-06 | KN303 15.49 G | KN303C 19.89 G |
| 998           | SXT1100 232 LIMITED ENG 1 | 08-09 | KN204 15.49 G | KN204C 18.79 G |
| 998           | SXT1100 232 LIMITED ENG 2 | 08-09 | KN204 15.49 G | KN204C 18.79 G |
| 998           | SXT1100 AR230 H.O. ENG 1  | 07    | KN303 15.49 G | KN303C 19.89 G |
| 998           | SXT1100 AR230 H.O. ENG 1  | 08-09 | KN204 15.49 G | KN204C 18.79 G |
| 998           | SXT1100 AR230 H.O. ENG 2  | 07    | KN303 15.49 G | KN303C 19.89 G |
| 998           | SXT1100 AR230 H.O. ENG 2  | 08-09 | KN204 15.49 G | KN204C 18.79 G |
| 998           | SXT1100 SR230 H.O.        | 07    | KN303 15.49 G | KN303C 19.89 G |
| 998           | SXT1100 SR230 H.O. ENG 2  | 07    | KN303 15.49 G | KN303C 19.89 G |
| 998           | SXT1100 SX230 H.O.        | 07    | KN303 15.49 G | KN303C 19.89 G |
| 998           | SXT1100 SX230 H.O.        | 08-09 | KN204 15.49 G | KN204C 18.79 G |
| 998           | SXT1100 SX230 H.O. ENG 2  | 07    | KN303 15.49 G | KN303C 19.89 G |
| 998           | SXT1100 SX230 H.O. ENG 2  | 08-09 | KN204 15.49 G | KN204C 18.79 G |
| 998           | VX1100 WAVERUNNER C       | 07    | KN303 15.49 G | KN303C 19.89 G |
| 998           | VX1100 WAVERUNNER C       | 08    | KN204 15.49 G | KN204C 18.79 G |
| 998           | VX1100 WAVERUNNER DELUXE  | 05-07 | KN303 15.49 G | KN303C 19.89 G |
| 998           | VX1100 WAVERUNNER DELUXE  | 08    | KN204 15.49 G | KN204C 18.79 G |
| 998           | VX1100 WAVERUNNER SPORT   | 05-07 | KN303 15.49 G | KN303C 19.89 G |
| 998           | VX1100 WAVERUNNER SPORT   | 08    | KN204 15.49 G | KN204C 18.79 G |
| 998           | VX1100 WAVERUNNER VX      | 07    | KN303 15.49 G | KN303C 19.89 G |
| 998           | VX1100 WAVERUNNER VX      | 08    | KN204 15.49 G | KN204C 18.79 G |
| 1000          | SRT1000 AR230             | 06    | KN303 15.49 G | KN303C 19.89 G |
| 1100          | SXT1100 232 LIMITED S     | 09    | KN204 15.49 G | KN204C 18.79 G |
| 1100          | VX1100 WAVERUNNER C       | 09-14 | KN204 15.49 G | KN204C 18.79 G |
| 1100          | VX1100 WAVERUNNER DELUXE  | 09-14 | KN204 15.49 G | KN204C 18.79 G |
| 1100          | VX1100 WAVERUNNER SPORT   | 09-14 | KN204 15.49 G | KN204C 18.79 G |

\* Takes 2 Filters



## WHY HIFLO?

Providing unbeatable performance and exceptional value, Hiflofiltro is the best-selling brand of aftermarket filters for motorcycles, scooters, and ATVs worldwide. The filters are also supplied to original equipment manufacturers as well as private label brands.

## PREMIUM OIL FILTERS

Hiflofiltro is the world's first TÜV approved oil filter. Constructed using the best materials available, all Hiflofiltro oil filters meet or exceed original equipment performance levels.



| MODEL                               | YEAR  | PART # |        |
|-------------------------------------|-------|--------|--------|
| <b>HONDA OUTBOARD</b>               |       |        |        |
| 9.9 hp                              | 01-   | 982061 | 8.15 Q |
| 15 hp                               | 03-   | 982061 | 8.15 Q |
| 20 hp                               | 03-   | 982061 | 8.15 Q |
| 25 hp                               | 01-05 | 982064 | 8.15 Q |
| 25 hp                               | 05-   | 982061 | 8.15 Q |
| 30 hp                               | 01-05 | 982064 | 8.15 Q |
| 30 hp                               | 05-   | 982061 | 8.15 Q |
| 40 hp                               | 01-05 | 982064 | 8.15 Q |
| 40 hp                               | 05-   | 982061 | 8.15 Q |
| 50 hp                               | 00-05 | 982064 | 8.15 Q |
| 50 hp                               | 05-   | 982061 | 8.15 Q |
| 75 hp                               | 00-   | 982027 | 8.65 Q |
| 90 hp                               | 00-   | 982027 | 8.65 Q |
| 115 hp                              | 00-06 | 982027 | 8.65 Q |
| 115 hp                              | 07-   | 982027 | 8.65 Q |
| 130 hp                              | 00-04 | 982027 | 8.65 Q |
| 135 hp                              | 05-   | 982027 | 8.65 Q |
| 150 hp                              | 04-   | 982027 | 8.65 Q |
| 200 hp                              | 02-07 | 982027 | 8.65 Q |
| 200 hp                              | 07-   | 982027 | 8.65 Q |
| 225 hp                              | 02-06 | 982027 | 8.65 Q |
| 225 hp                              | 07-   | 982027 | 8.65 Q |
| <b>HONDA PERSONAL WATERCRAFT</b>    |       |        |        |
| AquaTrax F-15                       | 09    | 982061 | 8.15 Q |
| AquaTrax F-15X                      | 08-09 | 982061 | 8.15 Q |
| AquaTrax F-12                       | 02-07 | 982061 | 8.15 Q |
| AquaTrax F-12X                      | 02-07 | 982061 | 8.15 Q |
| AquaTrax R-12X                      | 03-07 | 982061 | 8.15 Q |
| AquaTrax R-12                       | 04-06 | 982061 | 8.15 Q |
| AquaTrax F-12X GPScape              | 05-07 | 982061 | 8.15 Q |
| AquaTrax F-15X GPScape              | 08-09 | 982061 | 8.15 Q |
| <b>KAWASAKI PERSONAL WATERCRAFT</b> |       |        |        |
| Jet Ski STX-12F                     | 03-07 | 982064 | 8.15 Q |
| Jet Ski STX                         | 09-10 | 982064 | 8.15 Q |
| Jet Ski STX 15F                     | 04-10 | 982064 | 8.15 Q |
| Jet Ski STX 15F                     | 11-16 | 982061 | 8.15 Q |
| Jet Ski Ultra 250X                  | 07-08 | 982061 | 8.15 Q |
| Jet Ski Ultra 260LX                 | 09-12 | 982061 | 8.15 Q |
| Jet Ski Ultra 260X                  | 09-12 | 982061 | 8.15 Q |
| Jet Ski Ultra 300LX                 | 11-12 | 982061 | 8.15 Q |
| Jet Ski Ultra 300X                  | 11-12 | 982061 | 8.15 Q |

|                                    |       |        |        |
|------------------------------------|-------|--------|--------|
| Jet Ski Ultra 310R                 | 14-16 | 982061 | 8.15 Q |
| Jet Ski Ultra 310LX                | 14    | 982061 | 8.15 Q |
| Jet Ski Ultra 310X                 | 14-16 | 982061 | 8.15 Q |
| Jet Ski Ultra 310X SE              | 14-16 | 982061 | 8.15 Q |
| Jet Ski Ultra LX                   | 07-11 | 982064 | 8.15 Q |
| Jet Ski Ultra LX                   | 12-16 | 982061 | 8.15 Q |
| <b>MERCURY / MARINER OUTBOARD</b>  |       |        |        |
| Fourstroke 25 Carb                 |       | 982061 | 8.15 Q |
| Fourstroke 25 Carb                 |       | 982027 | 8.65 Q |
| FourStroke 25 EFI                  |       | 982061 | 8.15 Q |
| FourStroke Jet 25                  |       | 982061 | 8.15 Q |
| Fourstroke 30 Carb                 |       | 982027 | 8.65 Q |
| FourStroke 30 EFI                  |       | 982027 | 8.65 Q |
| FourStroke 30 EFI                  |       | 982061 | 8.15 Q |
| FourStroke 30 EFI                  |       | 982027 | 8.65 Q |
| FourStroke 40 Carb (3 cyl)         |       | 982027 | 8.65 Q |
| FourStroke 40 EFI (3 cyl)          |       | 982027 | 8.65 Q |
| FourStroke 40 EFI Jet (4 cyl)      |       | 982027 | 8.65 Q |
| FourStroke 40 EFI (4 cyl)          |       | 982027 | 8.65 Q |
| FourStroke 50 EFI (4 cyl)          |       | 982027 | 8.65 Q |
| FourStroke 60 EFI (4 cyl)          |       | 982027 | 8.65 Q |
| FourStroke 75 EFI                  |       | 982027 | 8.65 Q |
| FourStroke 80 EFI                  |       | 982027 | 8.65 Q |
| FourStroke 90 EFI                  |       | 982027 | 8.65 Q |
| FourStroke 100 EFI                 |       | 982027 | 8.65 Q |
| FourStroke 115 EFI                 |       | 982027 | 8.65 Q |
| <b>NISSAN OUTBOARD</b>             |       |        |        |
| NSF 15                             |       | 982059 | 8.65 Q |
| NSF 20                             |       | 982059 | 8.65 Q |
| NSF 25                             |       | 982059 | 8.65 Q |
| NSF 30                             |       | 982059 | 8.65 Q |
| <b>SUZUKI OUTBOARD</b>             |       |        |        |
| DF9.9 / 9.9A                       | 96-10 | 982010 | 3.80 Q |
| DF9.9 / 9.9A                       | 11-   | 982010 | 3.80 Q |
| DF15                               | 96-10 | 982010 | 3.80 Q |
| DF15                               | 11-   | 982010 | 3.80 Q |
| DF140                              | 02-10 | 982009 | 8.85 Q |
| DF140                              | 11-   | 982009 | 8.85 Q |
| <b>SEA-DOO PERSONAL WATERCRAFT</b> |       |        |        |
| GTI                                | 06    | 982072 | 7.95 Q |
| GTI 130                            | 08-12 | 982072 | 7.95 Q |

- accessories
- towables
- body
- controls
- electrical
- driveline
- engine**
- fuel & intake
- chemicals
- tie downs
- tools
- towing & loading

# MARINE

## HIFLO PREMIUM OIL FILTERS CONTINUED

- accessories
- towables
- body
- controls
- electrical
- driveline
- engine**
- fuel & intake
- chemicals
- tie downs
- tools
- towing & loading

| MODEL  | YEAR  | PART # |        |
|--|-------|--------|--------|
| <b>SEA-DOO PERSONAL WATERCRAFT CONTINUED</b> |       |        |        |
| GTI 4-TEC                                    | 07    | 982072 | 7.95 Q |
| GTI 4-TEC Rental                             | 07    | 982072 | 7.95 Q |
| GTI 4-TEC SE                                 | 07    | 982072 | 7.95 Q |
| GTI Limited 155                              | 11-16 | 982072 | 7.95 Q |
| GTI Rental                                   | 06    | 982072 | 7.95 Q |
| GTI Rental 130                               | 08    | 982072 | 7.95 Q |
| GTI SE                                       | 06    | 982072 | 7.95 Q |
| GTI SE 155/130                               | 08-16 | 982072 | 7.95 Q |
| GTR 215                                      | 12-16 | 982072 | 7.95 Q |
| GTS 130                                      | 11-16 | 982072 | 7.95 Q |
| GTX  | 07    | 982072 | 7.95 Q |
| GTX 215/155                                  | 08-12 | 982072 | 7.95 Q |
| GTX 4-TEC                                    | 02-06 | 982072 | 7.95 Q |
| GTX 4-TEC LTD                                | 03-06 | 982072 | 7.95 Q |
| GTX 4-TEC SC (Supercharged)                  | 03-06 | 982072 | 7.95 Q |
| GTX 4-TEC WAKE                               | 03-06 | 982072 | 7.95 Q |
| GTX iS 215                                   | 10-11 | 982072 | 7.95 Q |
| GTX Limited iS 260                           | 10-16 | 982072 | 7.95 Q |
| GTX LTD                                      | 07    | 982072 | 7.95 Q |
| GTX S 155                                    | 12    | 982072 | 7.95 Q |
| GTX WAKE                                     | 07    | 982072 | 7.95 Q |
| RXP  | 04-07 | 982072 | 7.95 Q |
| RXP-X 255                                    | 08-11 | 982072 | 7.95 Q |
| RXP-X 260                                    | 12-16 | 982072 | 7.95 Q |
| RXT  | 05-07 | 982072 | 7.95 Q |
| RXT 260                                      | 11-16 | 982072 | 7.95 Q |
| RXT iS 260                                   | 10-12 | 982072 | 7.95 Q |
| RXT-X 260                                    | 10-16 | 982072 | 7.95 Q |
| RXT-X aS 260                                 | 10-16 | 982072 | 7.95 Q |
| Wake 155                                     | 08-16 | 982072 | 7.95 Q |
| Wake Pro 215                                 | 08-16 | 982072 | 7.95 Q |

| <b>TOHATSU OUTBOARD</b> |     |        |        |
|-------------------------|-----|--------|--------|
| MFS 15                  | All | 982059 | 8.65 Q |
| MFS 20                  | All | 982059 | 8.65 Q |
| MFS 25                  | All | 982059 | 8.65 Q |
| MFS 30                  | All | 982059 | 8.65 Q |

| <b>YAMAHA OUTBOARD</b> |       |        |        |
|------------------------|-------|--------|--------|
| F15                    | 00-05 | 982064 | 8.15 Q |
| F15 Portable           | 06-   | 982061 | 8.15 Q |
| F20 Portable           | 06-   | 982061 | 8.15 Q |
| F25                    | 00-05 | 982064 | 8.15 Q |
| T25 High Thrust        | 06-   | 982061 | 8.15 Q |
| F25 Midrange           | 06-   | 982061 | 8.15 Q |
| F30                    | 01-05 | 982064 | 8.15 Q |
| F40                    | 00-05 | 982064 | 8.15 Q |
| F40 Jet Drive          | 06-   | 982061 | 8.15 Q |
| F40 Midrange           | 06-   | 982064 | 8.15 Q |
| F50                    | 00-05 | 982064 | 8.15 Q |
| F50 Midrange           | 06-   | 982061 | 8.15 Q |
| T50 High Thrust        | 06-   | 982061 | 8.15 Q |
| F60                    | 02-05 | 982064 | 8.15 Q |
| F60 Midrange           | 06-   | 982061 | 8.15 Q |
| F60 Jet Drive          | 06-   | 982061 | 8.15 Q |

|                   |       |        |        |
|-------------------|-------|--------|--------|
| T60 High Thrust   | 06-   | 982061 | 8.15 Q |
| F70 Midrange      | 06-   | 982061 | 8.15 Q |
| F75               | 03-05 | 982064 | 8.15 Q |
| F75 Midrange      | 06-   | 982064 | 8.15 Q |
| F80               | 00-03 | 982064 | 8.15 Q |
| F90               | 03-05 | 982064 | 8.15 Q |
| F90 Jet Drive     | 06-   | 982064 | 8.15 Q |
| F90 Midrange      | 06-   | 982064 | 8.15 Q |
| F100              | 00-03 | 982064 | 8.15 Q |
| F115              | 00-05 | 982064 | 8.15 Q |
| F115 In Line Four | 06-   | 982064 | 8.15 Q |
| F115 Jet Drive    | 06-   | 982064 | 8.15 Q |
| F150              | 04-05 | 982571 | 9.09 L |
| F150 In Line Four | 06-   | 982571 | 9.09 L |
| F150 Jet Drive    | 06-   | 982571 | 9.09 L |
| F200              | 02-05 | 982571 | 9.09 L |
| F200 High Power   | 06-   | 982571 | 9.09 L |
| F225              | 02-05 | 982571 | 9.09 L |
| F225 High Power   | 06-   | 982571 | 9.09 L |
| Sport Model 225   | 06-   | 982571 | 9.09 L |
| F250              | 05    | 982571 | 9.09 L |
| F250 High Power   | 06-   | 982571 | 9.09 L |
| VF200             | 11-   | 982572 | 9.09 L |
| VF225             | 11-   | 982572 | 9.09 L |
| VF250             | 11-   | 982572 | 9.09 L |
| F225 V6 Offshore  | 11-   | 982572 | 9.09 L |
| F250 V6 Offshore  | 11-   | 982572 | 9.09 L |
| F300 V6 Offshore  | 11-   | 982572 | 9.09 L |
| F350 V8 5.3l      | 06-   | 982572 | 9.09 L |

| <b>YAMAHA PERSONAL WATERCRAFT</b> |       |        |        |
|-----------------------------------|-------|--------|--------|
| FX                                | 05-07 | 982064 | 8.15 Q |
| FX                                | 08    | 982061 | 8.15 Q |
| FX Cruiser                        | 05-07 | 982064 | 8.15 Q |
| FX Cruiser                        | 08    | 982061 | 8.15 Q |
| FX Cruiser HO                     | 04-07 | 982064 | 8.15 Q |
| FX Cruiser HO                     | 08    | 982061 | 8.15 Q |
| FX Cruiser HO                     | 09-16 | 982571 | 9.09 L |
| FX HO                             | 09-16 | 982571 | 9.09 L |
| FX SHO                            | 09-16 | 982571 | 9.09 L |
| FX Cruiser SHO                    | 09-16 | 982571 | 9.09 L |
| FX HO                             | 04-07 | 982064 | 8.15 Q |
| FX HO                             | 08    | 982061 | 8.15 Q |
| FX140                             | 02-04 | 982064 | 8.15 Q |
| FX140 Cruiser                     | 03-04 | 982064 | 8.15 Q |
| FZR                               | 09-16 | 982571 | 9.09 L |
| FZS                               | 10-16 | 982571 | 9.09 L |
| VX                                | 07    | 982064 | 8.15 Q |
| VX Cruiser                        | 07    | 982064 | 8.15 Q |
| VX Cruiser                        | 08-12 | 982061 | 8.15 Q |
| VX Deluxe                         | 07    | 982064 | 8.15 Q |
| VX Deluxe                         | 08-12 | 982061 | 8.15 Q |
| VX Sport                          | 07    | 982064 | 8.15 Q |
| VX Sport                          | 08-12 | 982061 | 8.15 Q |
| VX110 Deluxe                      | 05-06 | 982064 | 8.15 Q |
| VX110 Sport                       | 05-06 | 982064 | 8.15 Q |
| VXR                               | 11-16 | 982571 | 9.09 L |
| VXS                               | 11-16 | 982571 | 9.09 L |



## FLUSH KITS

- Allows easy flushing of cooling system to keep it at peak efficiency
- Cleans system of debris and contaminants including saltwater, sand and sediment
- Kits designed for specific applications
- Replacement adapter hoses with quick-snap ends available separately



accessories

towables

body

controls

electrical

driveline

engine

fuel & intake

chemicals

tie downs

tools

towing & loading

MARINE



## FLUSH KITS

- Allows easy flushing of cooling system to keep it at peak efficiency
- Cleans system of debris and contaminants including saltwater, sand and sediment
- Kits designed for specific applications
- Replacement adapter hoses with quick-snap ends available separately

accessories

towables

body

controls

electrical

driveline

engine

fuel & intake

chemicals

tie downs

tools

towing & loading



## ATLANTIS FLUSH KITS CONTINUED

| APPLICATION          | YEAR  | PART # |         |
|----------------------|-------|--------|---------|
| <b>ARCTIC CAT</b>    |       |        |         |
| TIGERSHARK           | ALL   | 983010 | 11.95 B |
| <b>HONDA</b>         |       |        |         |
| F-12X                | 02-07 | 983011 | 44.95 B |
| F-15X                | 08-09 | 983012 | 14.50 B |
| F-15X GPSCAPE        | 08-09 | 983012 | 14.50 B |
| R-12X                | 02-07 | 983011 | 44.95 B |
| <b>POLARIS</b>       |       |        |         |
| FREEDOM              | 02-04 | 983013 | 15.95 B |
| FREEDOM              | 02-04 | 983014 | 39.95 B |
| FREEDOM              | 02-04 | 983015 | 59.95 B |
| GENESIS (CARBURATED) | 99-02 | 983013 | 15.95 B |
| GENESIS (CARBURATED) | 99-02 | 983014 | 39.95 B |
| GENESIS (CARBURATED) | 99-02 | 983015 | 59.95 B |
| GENESIS FFI          | 00    | 983016 | 14.95 B |
| GENESIS FFI          | 00    | 983017 | 45.50 B |
| GENESIS FICHT        | 99    | 983016 | 14.95 B |
| GENESIS FICHT        | 99    | 983017 | 45.50 B |
| GENESIS I            | 01    | 983016 | 14.95 B |
| GENESIS I            | 01    | 983017 | 45.50 B |
| HURRICANE            | 96-97 | 983013 | 15.95 B |
| HURRICANE            | 96-97 | 983014 | 39.95 B |
| HURRICANE            | 96-97 | 983015 | 59.95 B |
| MSX110               | 04    | 983000 | 58.50 B |
| MSX110               | 04    | 983018 | 14.95 B |
| MSX140               | 03-04 | 983000 | 58.50 B |
| MSX140               | 03-04 | 983018 | 14.95 B |
| MSX150               | 04    | 983000 | 58.50 B |
| MSX150               | 04    | 983018 | 14.95 B |
| OCTANE               | 02-04 | 983013 | 15.95 B |
| OCTANE               | 02-04 | 983014 | 39.95 B |
| OCTANE               | 02-04 | 983015 | 59.95 B |
| PRO                  | 99-00 | 983013 | 15.95 B |
| PRO                  | 99-00 | 983014 | 39.95 B |
| PRO                  | 99-00 | 983015 | 59.95 B |
| SL650                | 94-95 | 983013 | 15.95 B |
| SL650                | 94-95 | 983014 | 39.95 B |
| SL650                | 94-95 | 983015 | 59.95 B |
| SL700                | 96-97 | 983013 | 15.95 B |
| SL700                | 96-97 | 983014 | 39.95 B |
| SL700                | 96-97 | 983015 | 59.95 B |
| SL750                | 94-95 | 983013 | 15.95 B |
| SL750                | 94-95 | 983014 | 39.95 B |
| SL750                | 94-95 | 983015 | 59.95 B |
| SL780                | 96-97 | 983013 | 15.95 B |
| SL780                | 96-97 | 983014 | 39.95 B |

| APPLICATION                                      | YEAR      | PART # |         |
|--|-----------|--------|---------|
| <b>POLARIS CONTINUED</b>                         |           |        |         |
| SL780  | 96-97     | 983015 | 59.95 B |
| SL900  | 96-97     | 983013 | 15.95 B |
| SL900  | 96-97     | 983014 | 39.95 B |
| SL900  | 96-97     | 983015 | 59.95 B |
| SLH  | 97-98     | 983013 | 15.95 B |
| SLH  | 97-98     | 983015 | 59.95 B |
| SLH  | 98-01     | 983014 | 39.95 B |
| SLT700   | 96-97     | 983013 | 15.95 B |
| SLT700   | 96-97     | 983014 | 39.95 B |
| SLT700   | 96-97     | 983015 | 59.95 B |
| SLT750   | 94-95     | 983013 | 15.95 B |
| SLT750   | 94-95     | 983014 | 39.95 B |
| SLT750   | 94-95     | 983015 | 59.95 B |
| SLT780   | 96-97     | 983013 | 15.95 B |
| SLT780   | 96-97     | 983014 | 39.95 B |
| SLT780   | 96-97     | 983015 | 59.95 B |
| SLTH   | 98-99     | 983014 | 39.95 B |
| SLTX   | 96-97     | 983013 | 15.95 B |
| SLTX   | 96-97     | 983014 | 39.95 B |
| SLTX   | 96-97     | 983015 | 59.95 B |
| SLTX   | 98-99     | 983014 | 39.95 B |
| SLX  | 98-99     | 983013 | 15.95 B |
| SLX  | 98-99     | 983015 | 59.95 B |
| SLX  | 99-01     | 983014 | 39.95 B |
| SLX780   | 95-96     | 983013 | 15.95 B |
| SLX780   | 95-96     | 983014 | 39.95 B |
| SLX780   | 95-96     | 983015 | 59.95 B |
| SLX785   | 97-98     | 983014 | 39.95 B |
| SLXH   | 98        | 983014 | 39.95 B |
| SLXH   | 98-99     | 983013 | 15.95 B |
| SLXH   | 98-99     | 983015 | 59.95 B |
| VIRAGE (CARBURATED)                              | 00-04     | 983013 | 15.95 B |
| VIRAGE (CARBURATED)                              | 00-04     | 983014 | 39.95 B |
| VIRAGE (CARBURATED)                              | 00-04     | 983015 | 59.95 B |
| VIRAGE TX (CARBURATED)                           | 00-02     | 983013 | 15.95 B |
| VIRAGE TX (CARBURATED)                           | 00-02     | 983014 | 39.95 B |
| VIRAGE TX (CARBURATED)                           | 00-02     | 983015 | 59.95 B |
| VIRAGE TXI                                       | 01-04     | 983016 | 14.95 B |
| <b>KAWASAKI</b>                                  |           |        |         |
| 440 & 550  | 78-88     | 983019 | 14.95 B |
| 4-STROKE   | 03-04     | 983020 | 59.95 B |
| JETSKIS & ULTRA 150                              | 89-91     | 983021 | 14.95 B |
| JETSKIS & WET JETS                               | PRE<br>89 | 983022 | 14.95 B |
| JETSKIS EXCEPT ZXI, STX                          | 92-06     | 983023 | 14.95 B |
| JETSKIS EXCEPT ZXI, STX, ULTRA<br>150 QUICK SNAP | 92-02     | 983001 | 36.95 B |

accessories

towables

body

controls

electrical

driveline

engine

fuel &  
intake

chemicals

tie downs

tools

towing &  
loading

MARINE

## ATLANTIS FLUSH KITS CONTINUED

- accessories
- towables
- body
- controls
- electrical
- driveline
- engine**
- fuel & intake
- chemicals
- tie downs
- tools
- towing & loading

MARINE

| APPLICATION                                       | YEAR  | PART #        |                |
|---|-------|---------------|----------------|
| <b>KAWASAKI CONTINUED</b>                         |       |               |                |
| JETSKIS QUICK SNAP STYLE & ULTRA 150 QUICK SNAP S | 99-04 | <b>983002</b> | <b>36.95</b> B |
| ULTRA 300X, LX/ 300 SERIES                        | 11-12 | <b>983003</b> | <b>45.95</b> B |
| ZXI, STX  | ALL   | <b>983024</b> | <b>23.95</b> B |
| ZXI, STX QUICK SNAP                               | ALL   | <b>983025</b> | <b>44.95</b> B |
| <b>SEA-DOO</b>                                    |       |               |                |
| ALL NON-REAR DRAIN PIPE MODELS                    | 93-02 | <b>983026</b> | <b>19.95</b> B |
| ALL SEA-DOOS                                      | 89-92 | <b>983027</b> | <b>14.95</b> B |
| DELUXE SEA-DOO JET BOAT FLUSH KIT                 | 98-99 | <b>983004</b> | <b>55.95</b> B |
| DUAL ENGINE SEA-DOO BOATS                         | 95-97 | <b>983003</b> | <b>45.95</b> B |
| GT  | 90-91 | <b>983005</b> | <b>13.50</b> B |
| GTI   | 96    | <b>983005</b> | <b>13.50</b> B |
| GTS   | 92-00 | <b>983005</b> | <b>13.50</b> B |
| GTX   | 94-95 | <b>983006</b> | <b>12.50</b> B |
| GTX (580 ENGINE)                                  | 92-94 | <b>983005</b> | <b>13.50</b> B |
| LONG VERSION ALL REAR DRAIN PIPE MODELS           | ALL   | <b>983028</b> | <b>38.95</b> B |
| SEA-DOO DELUXE FLUSH KIT                          |       | <b>983029</b> | <b>21.95</b> B |
| SEA-DOO MERC JET BOAT FLUSH KIT                   | 00-02 | <b>983030</b> | <b>45.95</b> B |
| SEA-DOO PWC WITH REAR DRAIN                       | 96-08 | <b>983031</b> | <b>13.95</b> B |
| SHORT VERSION WITH REAR DRAIN                     |       | <b>983032</b> | <b>39.95</b> B |
| SINGLE ENGINE SEA-DOO BOATS                       |       | <b>983032</b> | <b>39.95</b> B |
| SP  | 89-97 | <b>983005</b> | <b>13.50</b> B |
| SPI   | 95    | <b>983006</b> | <b>12.50</b> B |
| SPI   | 96    | <b>983005</b> | <b>13.50</b> B |
| SPI   | 93-94 | <b>983005</b> | <b>13.50</b> B |
| SPX   | 95    | <b>983006</b> | <b>12.50</b> B |
| SPX   | 93-94 | <b>983005</b> | <b>13.50</b> B |
| SPX   | 96-99 | <b>983005</b> | <b>13.50</b> B |
| XP  | 91-96 | <b>983005</b> | <b>13.50</b> B |
| <b>YAMAHA</b>                                     |       |               |                |
| BLASTER   | 96    | <b>983033</b> | <b>16.95</b> B |
| BLASTER   | 96    | <b>983034</b> | <b>16.95</b> B |
| BLASTER 701                                       | 93-96 | <b>983035</b> | <b>16.95</b> B |
| BLASTER 701                                       | 93-96 | <b>983036</b> | <b>35.95</b> B |
| FX SERIES   | 03-12 | <b>983033</b> | <b>16.95</b> B |
| FX SERIES   | 03-12 | <b>983034</b> | <b>16.95</b> B |
| FX1   | 94-95 | <b>983035</b> | <b>16.95</b> B |
| FX1   | 94-95 | <b>983036</b> | <b>35.95</b> B |
| FZ SERIES   | 09-12 | <b>983033</b> | <b>16.95</b> B |
| FZ SERIES   | 09-12 | <b>983034</b> | <b>16.95</b> B |
| GP1200  | 97-99 | <b>983033</b> | <b>16.95</b> B |
| GP1200  | 97-99 | <b>983034</b> | <b>16.95</b> B |
| GP1200R   | 00-02 | <b>983033</b> | <b>16.95</b> B |
| GP1200R   | 00-02 | <b>983034</b> | <b>16.95</b> B |
| GP1300  | 03-08 | <b>983033</b> | <b>16.95</b> B |
| GP1300  | 03-08 | <b>983034</b> | <b>16.95</b> B |

| APPLICATION                       | YEAR  | PART #        |                |
|-----------------------------------|-------|---------------|----------------|
| <b>YAMAHA CONTINUED</b>           |       |               |                |
| GP800                             | 98-05 | <b>983033</b> | <b>16.95</b> B |
| GP800                             | 98-05 | <b>983034</b> | <b>16.95</b> B |
| JET BOATS                         | 96-12 | <b>983033</b> | <b>16.95</b> B |
| JET BOATS                         | 96-12 | <b>983034</b> | <b>16.95</b> B |
| RAIDER 1100                       | 95    | <b>983033</b> | <b>16.95</b> B |
| RAIDER 1100                       | 95    | <b>983034</b> | <b>16.95</b> B |
| RAIDER 701                        | 94-95 | <b>983035</b> | <b>16.95</b> B |
| RAIDER 701                        | 94-95 | <b>983036</b> | <b>35.95</b> B |
| RAIDER 760                        | 96    | <b>983033</b> | <b>16.95</b> B |
| RAIDER 760                        | 96    | <b>983034</b> | <b>16.95</b> B |
| SUPER JET                         | 90-10 | <b>983035</b> | <b>16.95</b> B |
| SUPER JET                         | 90-10 | <b>983036</b> | <b>35.95</b> B |
| SUV                               | 99-04 | <b>983033</b> | <b>16.95</b> B |
| SUV                               | 99-04 | <b>983034</b> | <b>16.95</b> B |
| VENTURE 701                       | 95-96 | <b>983035</b> | <b>16.95</b> B |
| VENTURE 701                       | 95-96 | <b>983036</b> | <b>35.95</b> B |
| VX SERIES                         | 05-12 | <b>983033</b> | <b>16.95</b> B |
| VX SERIES                         | 05-12 | <b>983034</b> | <b>16.95</b> B |
| VXR & VXR PRO                     | 92-95 | <b>983035</b> | <b>16.95</b> B |
| VXR & VXR PRO                     | 92-95 | <b>983036</b> | <b>35.95</b> B |
| WAVE RAIDER 700                   | 94-97 | <b>983037</b> | <b>35.95</b> B |
| WAVE RAIDER 700                   | 94-97 | <b>983038</b> | <b>14.95</b> B |
| WAVE RUNNER 760                   | 97-98 | <b>983033</b> | <b>16.95</b> B |
| WAVE RUNNER 760                   | 97-98 | <b>983034</b> | <b>16.95</b> B |
| WAVE RUNNER III                   | 92-97 | <b>983035</b> | <b>16.95</b> B |
| WAVE RUNNER III                   | 92-97 | <b>983036</b> | <b>35.95</b> B |
| WAVE RUNNER LX                    | 91-93 | <b>983035</b> | <b>16.95</b> B |
| WAVE RUNNER LX                    | 91-93 | <b>983036</b> | <b>35.95</b> B |
| WAVE VENTURE 1100                 | 96-97 | <b>983033</b> | <b>16.95</b> B |
| WAVE VENTURE 1100                 | 96-97 | <b>983034</b> | <b>16.95</b> B |
| XL1200                            | 98-01 | <b>983033</b> | <b>16.95</b> B |
| XL1200                            | 98-01 | <b>983034</b> | <b>16.95</b> B |
| XL760                             | 98-99 | <b>983033</b> | <b>16.95</b> B |
| XL760                             | 98-99 | <b>983034</b> | <b>16.95</b> B |
| XL800                             | 99-01 | <b>983033</b> | <b>16.95</b> B |
| XL800                             | 99-01 | <b>983034</b> | <b>16.95</b> B |
| XLT1200                           | 02-05 | <b>983033</b> | <b>16.95</b> B |
| XLT1200                           | 02-05 | <b>983034</b> | <b>16.95</b> B |
| XLT800                            | 02-04 | <b>983033</b> | <b>16.95</b> B |
| XLT800                            | 02-04 | <b>983034</b> | <b>16.95</b> B |
| YAMAHA OUTBOARD                   | ALL   | <b>983039</b> | <b>9.95</b> B  |
| <b>REPLACEMENT ATTACHMENTS</b>    |       |               |                |
| FLUSH FITTING, MALE, QUICK SNAP   |       | <b>983040</b> | <b>19.95</b> B |
| BACK FLUSH KIT, SINGLE            |       | <b>983007</b> | <b>22.00</b> B |
| BACK FLUSH KIT, DUAL              |       | <b>983008</b> | <b>30.00</b> B |
| FLUSH ADAPTER, FEMALE, QUICK SNAP |       | <b>983041</b> | <b>36.25</b> B |





# FUEL & INTAKE

## WSM INTAKE GASKETS

| MAKE/MODEL             | YEAR | CARBURETOR | DESCRIPTION        | OEM #    | QTY | PART #        | FIG  | REF |
|------------------------|------|------------|--------------------|----------|-----|---------------|------|-----|
| <b>ARCTIC CAT</b>      |      |            |                    |          |     |               |      |     |
| TIGER SHARK<br>640/770 |      |            | CARB GASKET        | 0673-090 | 1   | <b>326907</b> | 2.65 | L   |
|                        |      |            | REED VALVE GASKET  | 3008-076 | 4   | <b>326923</b> | 1.55 | L   |
|                        |      |            | AIR CLEANER GASKET | 3008-058 | 2   | <b>326924</b> | 1.40 | L   |
| 900/1000/1100          |      |            | CARB GASKET        | 3008-057 | 3   | <b>326907</b> | 2.65 | L   |
|                        |      |            | REED VALVE GASKET  | 3008-076 | 3   | <b>326923</b> | 1.55 | L   |
|                        |      |            | AIR CLEANER GASKET | 1673-091 | 3   | <b>326926</b> | 1.40 | L   |

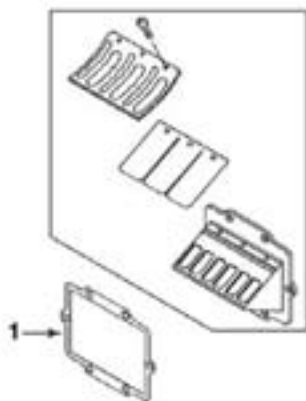

**KAWASAKI  
FIG. 1**

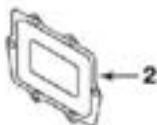

| <b>KAWASAKI</b> |       |  |                         |            |   |               |      |       |
|-----------------|-------|--|-------------------------|------------|---|---------------|------|-------|
| 300 SX          | 86-91 | MIKUNI BN34/28mm<br>SINGLE CARB          | CARB GASKET             | 11009-3786 | 2 | <b>326857</b> | 1.05 | L     |
|                 |       |  | FLAME ARRESTOR          | 11060-3702 | 2 | <b>326920</b> | 1.20 | L     |
| 440 SX          | 77-92 | MIKUNI BN38/34mm<br>SINGLE CARB          | REED VALVE              | 11060-3703 | 2 | <b>326861</b> | 1.50 | L     |
|                 |       |  | CARB GASKET             | 11009-3786 | 3 | <b>326857</b> | 1.05 | L     |
|                 |       |  | FLAME ARRESTOR          | 11060-3702 | 2 | <b>326920</b> | 1.20 | L     |
| 550 SX          | 87-90 | MIKUNI BN44/40mm<br>SINGLE CARB          | INTAKE MANIFOLD         | 11009-3785 | 2 | <b>326864</b> | 1.35 | L     |
|                 |       |  | CARB GASKET             | 11009-3056 | 2 | <b>326856</b> | 1.65 | L     |
|                 |       |  | FLAME ARRESTOR          | 11009-3057 | 1 | <b>326859</b> | 0.80 | L     |
| 550 SX          | 91-95 | KEIHIN CDK38mm<br>SINGLE CARB            | INTAKE MANIFOLD         | 11009-3785 | 2 | <b>326864</b> | 1.35 | L     |
|                 |       |  | CARB GASKET             | 11060-3716 | 1 | <b>326848</b> | 1.95 | L     |
|                 |       |  | REED VALVE GASKET       | 11009-3787 | 2 | <b>326897</b> | 1.95 | L     |
| 650 SC/SX/X2    | 90-95 | KEIHIN CDK38/32mm<br>SINGLE CARB         | CARB GASKET             | 11060-3716 | 1 | <b>326848</b> | 1.95 | L     |
|                 |       |  | REED VALVE GASKET       | 11060-3703 | 4 | <b>326861</b> | 1.50 | L     |
| 650 SX          | 87-90 | KEIHIN 28mm<br>SINGLE CARB               | CARB GASKET             |            | 1 | <b>326860</b> | 2.15 | L     |
|                 |       |  | FLAME ARRESTOR          | 11009-3727 | 3 | <b>326858</b> | 0.95 | L     |
|                 |       |  | REED VALVE GASKET       | 11009-3703 | 4 | <b>326861</b> | 1.50 | L     |
| 650 TS          | 89-90 | KEIHIN 28mm<br>SINGLE CARB               | CARB GASKET             |            | 1 | <b>326860</b> | 2.15 | L     |
|                 |       |  | REED VALVE GASKET       | 11009-3703 | 4 | <b>326861</b> | 1.50 | L     |
| 650 TS          | 91-95 | KEIHIN CDK38/32mm<br>SINGLE CARB         | CARB GASKET             | 11060-3716 | 1 | <b>326848</b> | 1.95 | L     |
|                 |       |  | REED VALVE GASKET       | 11060-3703 | 4 | <b>326861</b> | 1.50 | L     |
| 650 X2          | 89-90 | KEIHIN 28mm<br>SINGLE CARB               | CARB GASKET             |            | 1 | <b>326860</b> | 2.15 | L     |
|                 |       |  | REED VALVE GASKET       | 11060-3703 | 4 | <b>326861</b> | 1.50 | L     |
| 750 SS          | 92-97 | KEIHIN CDK40/34mm<br>38mm<br>SINGLE CARB | CARB GASKET             | 11060-3716 | 1 | <b>326848</b> | 1.95 | L     |
| 750 SSXi        | 93-97 |  | REED VALVE GASKET       | 11060-3717 | 4 | <b>326944</b> | 2.25 | L     |
| 750 ST          | 94-95 |  |                         |            |   |               |      |       |
| 750 SX          | 92-95 |  |                         |            |   |               |      |       |
| 750 XiR         | 94    |  |                         |            |   |               |      |       |
| 750 SSXi        | 93-97 | KEIHIN CDK II 40                         | CARB GASKET             | 11060-3758 | 2 | <b>326848</b> | 1.95 | L     |
| 750 STS/ZXi     | 95-97 |  | REED GASKET to CASE     | 11060-3717 | 2 | <b>326944</b> | 2.25 | L 1 1 |
| 750 SXi         | 95-96 |  | REED GASKET to MANIFOLD | 11060-3757 | 2 | <b>326704</b> | 4.40 | L 1 2 |
| 750 STX         | 98    |  |                         |            |   |               |      |       |
| 750 Xi-Sport    | 98-99 |  |                         |            |   |               |      |       |
| 750 SXi Pro     | 98-02 | MIKUNI 40mm                              | CARB GASKET             | 1106-3761  | 2 | <b>326731</b> | 3.00 | L     |
| 800 SX-R        | 03-11 |  | REED GASKET to CASE     | 11060-3717 | 2 | <b>326944</b> | 2.25 | L 1 1 |
|                 |       |  | REED GASKET to MANIFOLD | 11060-3757 | 2 | <b>326704</b> | 4.40 | L 1 2 |
| 900 STS         | 01-03 | KEIHIN CDK II 38mm<br>TRIPLE CARB        | CARB GASKET             | 11060-3753 | 3 | <b>326707</b> | 6.65 | L     |
| 900 STX         | 97-06 |  | REED GASKET to CASE     | 11060-3717 | 3 | <b>326944</b> | 2.25 | L 1 1 |
| 900 ZXi         | 95-97 |  | REED GASKET to MANIFOLD | 11060-3757 | 3 | <b>326704</b> | 4.40 | L 1 2 |
| 1100 STX        | 97-99 | KEIHIN 38mm<br>TRIPLE CARB               | CARB GASKET             | 11060-3776 | 3 | <b>326731</b> | 3.00 | L     |
| 1100 ZXi        | 96-03 |  | REED VALVE GASKET       | 11060-3717 | 3 | <b>326944</b> | 2.25 | L 1 1 |
|                 |       |  | REED VALVE GASKET       | 11060-3757 | 3 | <b>326704</b> | 4.40 | L 1 2 |

- accessories
- towables
- body
- controls
- electrical
- driveline
- engine
- fuel & intake**
- chemicals
- tie downs
- tools
- towing & loading

**MARINE**

## WSM INTAKE GASKETS CONTINUED

| MAKE/MODEL                | YEAR  | CARBURETOR                 | DESCRIPTION       | OEM #      | QTY | PART #        | FIG    | REF |
|---------------------------|-------|----------------------------|-------------------|------------|-----|---------------|--------|-----|
| <b>KAWASAKI CONTINUED</b> |       |                            |                   |            |     |               |        |     |
| 1100 STX DI               | 00-03 |                            | REED VALVE GASKET | 11060-3717 | 3   | <b>326944</b> | 2.25 L | 1 1 |
| 1100 ULTRA 130 DI         | 01-04 |                            | REED VALVE GASKET | 11060-3757 | 3   | <b>326704</b> | 4.40 L | 1 2 |
| 1200 STX-R                | 02-05 | KEIHIN 38mm<br>TRIPLE CARB | CARB GASKET       | 11060-3776 | 3   | <b>326731</b> | 3.00 L |     |
| 1200 ULTRA 150            | 99-05 |                            | REED VALVE GASKET | 11060-3717 | 3   | <b>326944</b> | 2.25 L | 1 1 |
|                           |       |                            | REED VALVE GASKET | 11060-3757 | 3   | <b>326704</b> | 4.40 L | 1 2 |
| <b>POLARIS</b>            |       |                            |                   |            |     |               |        |     |
| 650/750                   |       |                            | CARB GASKET       | 3240128    | 3   | <b>326857</b> | 1.05 L |     |
|                           |       |                            | REED VALVE GASKET | 3084148    | 6   | <b>326919</b> | 1.25 L |     |
|                           |       |                            | FLAME ARRESTOR    | 5830013    | 3   | <b>326920</b> | 1.20 L |     |
| 700                       |       |                            | CARB GASKET       | 5830043    | 2   | <b>326850</b> | 2.80 L |     |
|                           |       |                            | FLAME ARRESTOR    | 5830062    | 2   | <b>326849</b> | 1.50 L |     |
| 780                       |       |                            | CARB GASKET       | 3240128    | 3   | <b>326857</b> | 1.05 L |     |
|                           |       |                            | REED VALVE GASKET | 3084148    | 9   | <b>326919</b> | 1.25 L |     |
|                           |       |                            | FLAME ARRESTOR    | 5830013    | 3   | <b>326920</b> | 1.20 L |     |
| 800                       |       |                            | CARB GASKET       | 5830043    | 2   | <b>326850</b> | 2.80 L |     |
|                           |       |                            | UPPER CARB GASKET | 5830062    | 2   | <b>326849</b> | 1.50 L |     |
| 900-1050                  |       |                            | CARB GASKET       | 5830043    | 3   | <b>326850</b> | 2.80 L |     |
|                           |       |                            | FLAME ARRESTOR    | 5830062    | 3   | <b>326849</b> | 1.50 L |     |
| 1200                      |       |                            | CARB GASKET       | 5830043    | 3   | <b>326850</b> | 2.80 L |     |

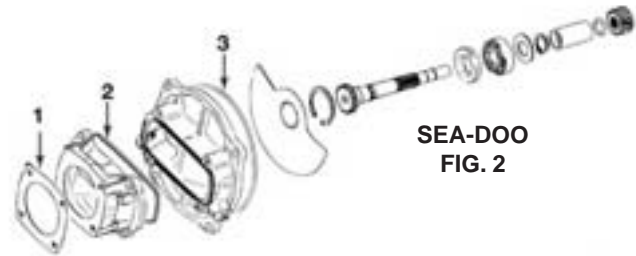
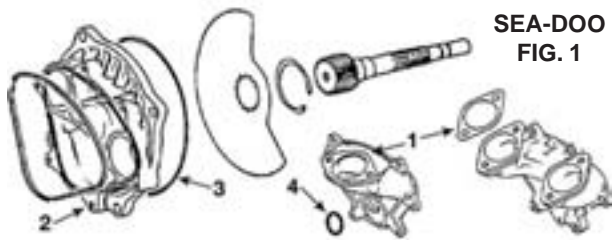

| <b>SEA-DOO</b>     |       |                            |                           |             |   |               |        |     |
|--------------------|-------|----------------------------|---------------------------|-------------|---|---------------|--------|-----|
| 580                | 90-91 | MIKUNI 38mm<br>SINGLE CARB | CARB GASKET               | 290-850-372 | 1 | <b>326857</b> | 1.05 L | 1 1 |
| 580 GTS            | 92-96 |                            | ROTARY COVER FRONT O-RING | 290-850-160 | 1 | <b>327197</b> | 2.35 L | 1 2 |
| 580 SP             | 95    |                            | ROTARY COVER REAR O-RING  | 293-300-023 | 1 | <b>327202</b> | 3.35 L | 1 3 |
| 580 SPi            | 95-96 |                            | OIL INJECTION O-RING      | 293-300-018 | 1 | <b>327162</b> | 0.70 P | 1 4 |
| 580 XP             | 91-92 |                            |                           |             |   |               |        |     |
| 580 GTX            | 92-93 | MIKUNI 38mm<br>SINGLE CARB | CARB GASKET               | 290-850-373 | 1 | <b>326857</b> | 1.05 L | 1 1 |
| 580 SP             | 91-94 |                            | ROTARY COVER FRONT O-RING | 290-831-705 | 1 | <b>327200</b> | 3.30 L | 1 2 |
| 580 SPi            | 93-94 |                            | ROTARY COVER REAR O-RING  | 293-300-023 | 1 | <b>327202</b> | 3.35 L | 1 3 |
| 580/650 SPX        | 93    |                            | OIL INJECTION O-RING      | 293-300-018 | 1 | <b>327162</b> | 0.70 P | 1 4 |
| 650 XP             | 93-94 |                            |                           |             |   |               |        |     |
| 650 GTX            | 95    | MIKUNI 38mm<br>DUAL CARB   | CARB GASKET               | 290-850-373 | 2 | <b>326857</b> | 1.05 L | 1 1 |
|                    |       |                            | ROTARY COVER FRONT O-RING | 290-931-440 | 1 | <b>327198</b> | 4.25 L | 1 2 |
|                    |       |                            | ROTARY COVER REAR O-RING  | 290-300-023 | 1 | <b>327202</b> | 3.35 L | 1 3 |
|                    |       |                            | OIL INJECTION O-RING      | 293-300-018 | 1 | <b>327162</b> | 0.70 P | 1 4 |
| 650 SPX            | 95    |                            | CARB GASKET               | 270-000-114 | 2 | <b>326958</b> | 1.45 L | 1 1 |
| 720 Gti/HX/SPX/XP  | 95-96 | MIKUNI 39mm<br>DUAL CARB   | ROTARY COVER FRONT O-RING | 290-931-440 | 1 | <b>327198</b> | 4.25 L | 1 2 |
|                    |       |                            | ROTARY COVER REAR O-RING  | 290-300-023 | 1 | <b>327202</b> | 3.35 L | 1 3 |
|                    |       |                            | OIL INJECTION O-RING      | 293-300-018 | 1 | <b>327162</b> | 0.70 P | 1 4 |
| 650 XPi            | 94    | MIKUNI 39mm<br>DUAL CARB   | CARB GASKET               | 270-000-114 | 2 | <b>326958</b> | 1.45 L | 1 1 |
|                    |       |                            | ROTARY COVER FRONT O-RING | 290-831-705 | 1 | <b>327200</b> | 3.30 L | 1 2 |
|                    |       |                            | ROTARY COVER REAR O-RING  | 293-300-023 | 1 | <b>327202</b> | 3.35 L | 1 3 |
|                    |       |                            | OIL INJECTION O-RING      | 293-300-018 | 1 | <b>327162</b> | 0.70 P | 1 4 |
| 720 GS/GSi/GTS/GTi | 97-98 | MIKUNI 39mm<br>SINGLE CARB | CARB GASKET               | 293-250-070 | 2 | <b>326958</b> | 1.45 L | 1 1 |
|                    |       |                            | ROTARY COVER FRONT O-RING | 290-850-160 | 1 | <b>327197</b> | 2.35 L | 1 2 |
|                    |       |                            | ROTARY COVER REAR O-RING  | 293-300-023 | 1 | <b>327202</b> | 3.35 L | 1 3 |
|                    |       |                            | OIL INJECTION O-RING      | 293-300-018 | 1 | <b>327162</b> | 0.70 P | 1 4 |
| 720 SP             | 97    | MIKUNI<br>SINGLE CARB      | CARB GASKET               | 290-850-373 | 2 | <b>326857</b> | 1.05 L | 1 1 |
|                    |       |                            | ROTARY COVER FRONT O-RING | 290-850-160 | 1 | <b>327197</b> | 2.35 L | 1 2 |
|                    |       |                            | ROTARY COVER REAR O-RING  | 293-300-023 | 1 | <b>327202</b> | 3.35 L | 1 3 |
|                    |       |                            | OIL INJECTION O-RING      | 293-300-018 | 1 | <b>327162</b> | 0.70 P | 1 4 |

accessories

towables

body

controls

electrical

driveline

engine

fuel &  
intake

chemicals

tie downs

tools

towing &  
loading

MARINE

## WSM INTAKE GASKETS CONTINUED

| MAKE/MODEL               | YEAR  | CARBURETOR     | DESCRIPTION               | OEM #       | QTY | PART #               | FIG | REF |
|--------------------------|-------|----------------|---------------------------|-------------|-----|----------------------|-----|-----|
| <b>SEA-DOO CONTINUED</b> |       |                |                           |             |     |                      |     |     |
| 800 XP                   | 95-99 | MIKUNI 40mm    | CARB GASKET               | 293-250-042 | 2   | <b>326958</b> 1.45 L | 1   | 1   |
| GSX/GTX                  | 96    | DUAL CARB      | ROTARY COVER O-RING       | 290-831-765 | 1   | <b>327214</b> 3.10 L | 1   | 3   |
| 800 GSX RFi              | 99-05 |                | THROTTLE BODY GASKET      | 293-250-071 | 1   | <b>326959</b> 6.60 L | 2   | 1   |
| GTX RFi                  | 98-02 |                | ROTARY COVER FRONT O-RING | 420-850-520 | 1   | <b>327209</b> 5.20 L | 2   | 2   |
|                          |       |                | ROTARY COVER O-RING       | 420-831-767 | 1   | <b>327214</b> 3.10 L | 2   | 3   |
| 951                      |       | 50mm DUAL CARB | CARB MOUNTING GASKET      | 270-500-384 | 2   | <b>326908</b> 3.70 L | 1   | 2   |

**YAMAHA  
FIG. 1**

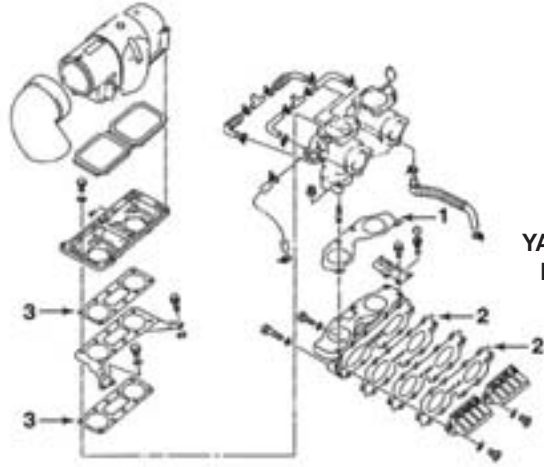
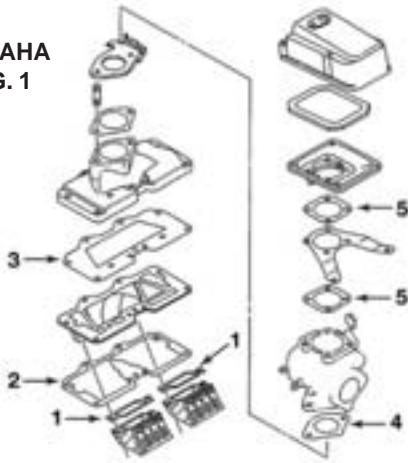

**YAMAHA  
FIG. 2**

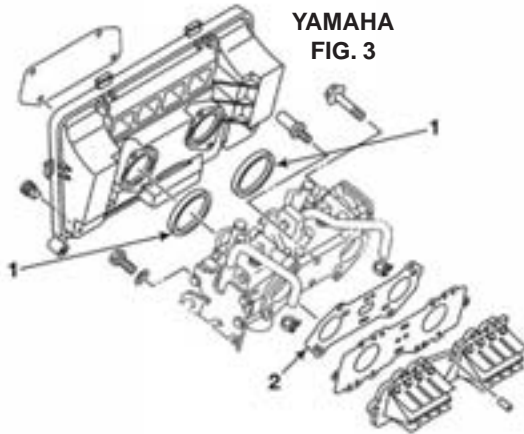

**YAMAHA  
FIG. 3**

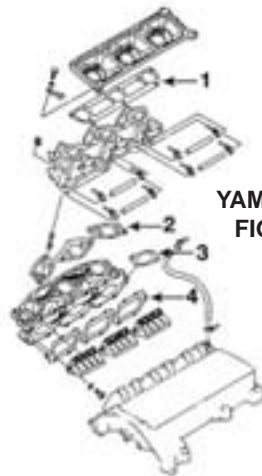

**YAMAHA  
FIG. 4**

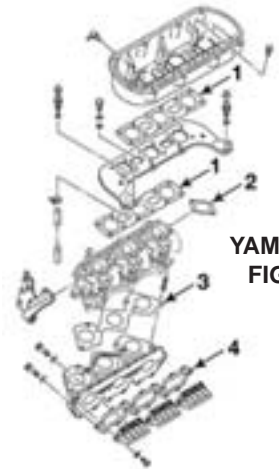

**YAMAHA  
FIG. 5**

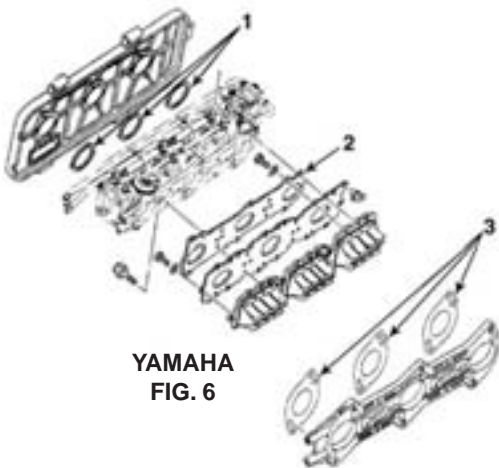

**YAMAHA  
FIG. 6**

**YAMAHA  
FIG. 7**

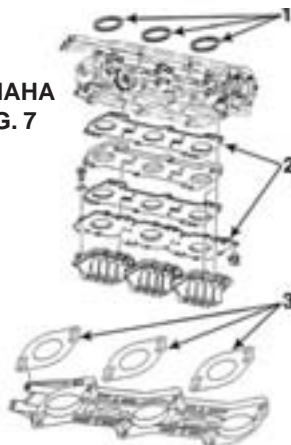

**YAMAHA  
FIG. 8**

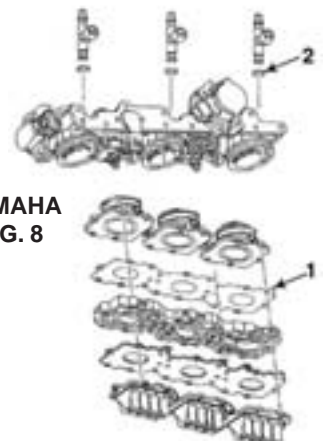

- accessories
- towables
- body
- controls
- electrical
- driveline
- engine
- fuel & intake**
- chemicals
- tie downs
- tools
- towing & loading

## WSM INTAKE GASKETS CONTINUED

| MAKE/MODEL                       | YEAR  | CARBURETOR                 | DESCRIPTION        | OEM #           | QTY | PART #              | FIG | REF |
|----------------------------------|-------|----------------------------|--------------------|-----------------|-----|---------------------|-----|-----|
| <b>YAMAHA</b>                    |       |                            |                    |                 |     |                     |     |     |
| 500 All                          |       |                            | CARB GASKET        | 6K8-13556-A2    | 2   | <b>326857 1.05</b>  | L   |     |
|                                  |       |                            | INTAKE MANIFOLD    | 6K8-13621-A1    | 1   | <b>326842 4.95</b>  | L   |     |
|                                  |       |                            | FLAME ARRESTOR     | 6K8-13674-A1    | 1   | <b>326843 0.85</b>  | L   |     |
| 650 All (6M6)                    |       | MIKUNI 44mm<br>SINGLE CARB | CARB GASKET        | 6M6-13556-A1    | 1   | <b>326910 1.65</b>  | L   | 1 4 |
|                                  |       |                            | INTAKE MANIFOLD    | 6M6-13566-A2    | 1   | <b>326844 3.70</b>  | L   | 1 2 |
|                                  |       |                            | INTAKE MANIFOLD    | 6M6-13563-A1    | 1   | <b>326845 3.85</b>  | L   | 1 3 |
|                                  |       |                            | REED VALVE GASKET  | 6M6-13621-00    | 2   | <b>326912 1.15</b>  | L   | 1 1 |
|                                  |       |                            | FLAME ARRESTOR     | 6M6-13674-00    | 2   | <b>326913 0.95</b>  | L   | 1 5 |
| 701 (61X)                        |       |                            | CARB GASKET        | 6M6-13556-00    | 2   | <b>326910 1.65</b>  | L   | 1 4 |
|                                  |       |                            | INTAKE MANIFOLD    | 61X-13563-A1    | 1   | <b>326942 3.15</b>  | L   | 1 3 |
|                                  |       |                            | INTAKE MANIFOLD    | 61X-13566-A1    | 1   | <b>326943 3.15</b>  | L   | 1 2 |
|                                  |       |                            | REED VALVE GASKET  | 61X-13621-A0    | 2   | <b>326941 1.00</b>  | L   | 1 1 |
|                                  |       |                            | FLAME ARRESTOR     | 6M6-13674-00    | 2   | <b>326913 0.95</b>  | L   | 1 5 |
| 701 (62T)                        |       |                            | CARB GASKET        | 62T-13556-00    | 1   | <b>326939 6.15</b>  | L   | 2 1 |
|                                  |       |                            | REED VALVE GASKET  | 62T-13566-00    | 2   | <b>326963 4.40</b>  | L   | 2 2 |
|                                  |       |                            | FLAME ARRESTOR     | 62T-13674-00    | 2   | <b>326914 2.15</b>  | L   | 2 3 |
| 760 All                          |       |                            | CARB GASKET        | 64X-13556-00    | 1   | <b>326745 6.20</b>  | L   | 2 1 |
|                                  |       |                            | REED VALVE GASKET  | 62T-13566-00    | 2   | <b>326963 4.40</b>  | L   | 2 2 |
|                                  |       |                            | FLAME ARRESTOR     | 64X-13674-00    | 2   | <b>326746 1.90</b>  | L   | 2 3 |
| 800 All                          |       |                            | CARB GASKETS       | 66E-14398-00    | 2   | <b>326684 4.50</b>  | L   | - - |
|                                  |       |                            | CARB COVER O-RINGS | 64X-14398-00    | 2   | <b>327258 1.05</b>  | L   | 3 1 |
|                                  |       |                            | MANIFOLD GASKET    | 66E-13556-00    | 1   | <b>326679 7.30</b>  | L   | 3 2 |
| 1100 (63M)                       | All   |                            | CARB GASKET        | 64X-14398-00    | 3   | <b>326910 1.65</b>  | L   | 4 3 |
|                                  |       |                            | MANIFOLD INTAKE    | 63M-13556-00    | 1   | <b>326698 10.85</b> | L   | 4 2 |
|                                  |       |                            | REED VALVE GASKET  | 63M-13566-00    | 2   | <b>326699 13.80</b> | L   | 4 4 |
|                                  |       |                            | FLAME ARRESTOR     | 63M-13674-00    | 1   | <b>326692 3.35</b>  | L   | 4 1 |
| 1200 (65U)<br>NON POWER<br>VALVE | All   |                            | CARB GASKET        | 64X-14398-00    | 3   | <b>326910 1.65</b>  | L   | 5 2 |
|                                  |       |                            | CARB PLATE GASKET  | 65U-13556-00    | 1   | <b>326697 11.05</b> | L   | 5 3 |
|                                  |       |                            | REED VALVE GASKET  | 63M-13566-00    | 1   | <b>326699 13.80</b> | L   | 5 4 |
|                                  |       |                            | FLAME ARRESTOR     | 65U-13674-00    | 2   | <b>326693 3.25</b>  | L   | 5 1 |
| 1200R<br>POWER VALVE<br>MOTOR    | 99-00 |                            | CARB COVER O-RINGS | 66E-13473-00    | 3   | <b>327258 1.05</b>  | L   | 6 1 |
|                                  |       |                            | MANIFOLD           | 66V-13556-00    | 1   | <b>326988 15.15</b> | L   | 6 2 |
|                                  |       |                            | CARB GASKET        | 66E-14398-00    | 3   | <b>326684 4.50</b>  | L   | 6 3 |
| 1200R<br>POWER VALVE<br>MOTOR    | 01-UP |                            | CARB COVER O-RINGS | 66E-13473-00    | 3   | <b>327258 1.05</b>  | L   | 7 1 |
|                                  |       |                            | MANIFOLD           | 68N-13556-00    | 2   | <b>326989 16.50</b> | L   | 7 2 |
|                                  |       |                            | CARB GASKET        | 66E-14398-00    | 3   | <b>326684 4.50</b>  | L   | 7 3 |
| 1300R                            | All   |                            | MANIFOLD           | 60T-13556-00-00 | 1   | <b>326990 12.35</b> | L   | 8 1 |
|                                  |       |                            | INJECTOR O-RING    | 60T-13766-00-00 | 3   | <b>327259 6.60</b>  | L   | 8 2 |

- accessories
- towables
- body
- controls
- electrical
- driveline
- engine
- fuel & intake**
- chemicals
- tie downs
- tools
- towing & loading

MARINE



### CDKII EXPLODED VIEW

#### KEIHIN CDKII

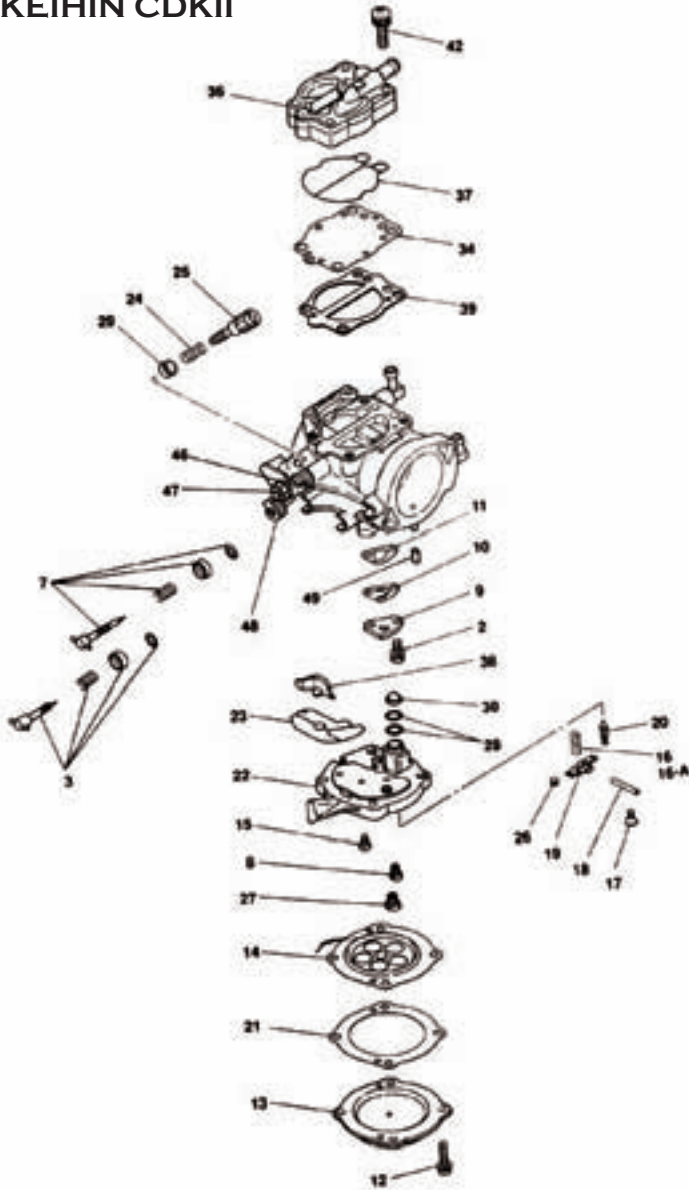

#### KEIHIN CDKII W/ACCELERATOR PUMP

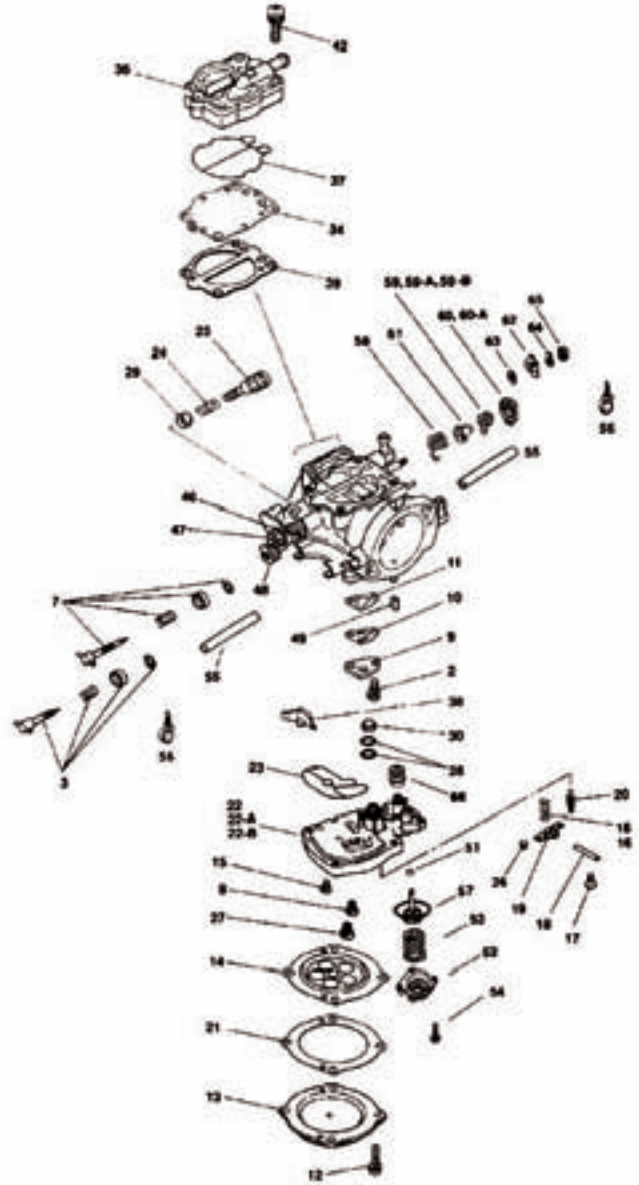

**Note: This exploded view is CDKII 42. NEVER try to remove parts which are not shown in this view.**

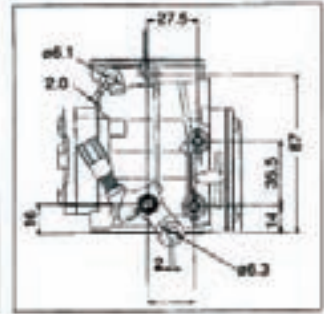
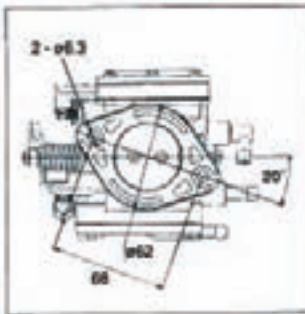
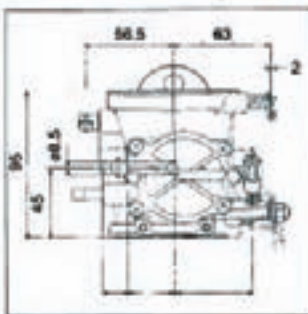
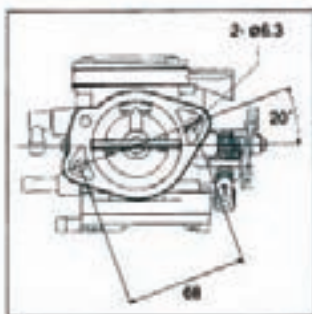



## CDKII PARTS & ACCESSORIES

| NO.  | DESCRIPTION        | KEIHIN CDKII      |               |              | KEIHIN CDKII W/ ACCELERATOR PUMP |                   |               |              |   |
|------|--------------------|-------------------|---------------|--------------|----------------------------------|-------------------|---------------|--------------|---|
|      |                    | KEIHIN #          | PART #        |              | KEIHIN #                         | PART #            |               |              |   |
| 2    | SCREW              | N114-03060        | <b>222173</b> | <b>0.84</b>  | L                                | N114-03060        | <b>222173</b> | <b>0.84</b>  | L |
| 3    | ADJUST SCREW(MAIN) | Z014-0660         | ----          |              |                                  | Z014-0660         | ----          |              |   |
| 7    | ADJUST SCREW(SLOW) | Z014-0670         | <b>222172</b> | <b>21.42</b> | L                                | Z014-0670         | <b>222172</b> | <b>21.42</b> | L |
| 8    | SLOW JET           | N424-35-QQQ       | ----          |              |                                  | N424-35-QQQ       | ----          |              |   |
| 9    | PLATE              | 1090-823-2000     | ----          |              |                                  | 1090-823-2000     | ----          |              |   |
| 10   | CHECK VALVE*       | 1242-809-2000*    | ----          |              |                                  | 1242-809-2000*    | ----          |              |   |
| 11   | GASKET*            | 1202-823-2000*    | <b>222174</b> | <b>5.09</b>  | L                                | 1202-823-2000*    | <b>222174</b> | <b>5.09</b>  | L |
| 12   | SCREW              | 0135-828-1900     | <b>222175</b> | <b>2.08</b>  | L                                | 0135-828-1900     | <b>222175</b> | <b>2.08</b>  | L |
| 13   | COVER              | 1230-827-2000     | ----          |              |                                  | 1230-827-2000     | ----          |              |   |
| 14   | DIAPHRAGM*         | 1201-813-2100*    | <b>222176</b> | <b>34.57</b> | L                                | 1201-813-2100*    | <b>222176</b> | <b>34.57</b> | L |
| 15   | SCREW              | 93500-04008-1H    | <b>222163</b> | <b>0.56</b>  | L                                | 93500-04008-1H    | <b>222163</b> | <b>0.56</b>  | L |
| 16   | COIL SPRING(70G)*  | 1290-947-2000*    | <b>222166</b> | <b>4.97</b>  | L                                | 1290-961-2000*    | ----          |              |   |
| 16A. | COIL SPRING(40G)   | 1290-966-2000     | <b>222167</b> | <b>2.48</b>  | L                                | 1290-992-2000     | <b>222178</b> | <b>2.31</b>  | L |
| 17   | SCREW              | 4114-001-1200     | ----          |              |                                  | 4114-001-1200     | ----          |              |   |
| 18   | ARM PIN            | 16152-KG8-9010-M1 | ----          |              |                                  | 16152-KG8-9010-M1 | ----          |              |   |
| 19   | FLOAT ARM          | 1054-823-2000     | ----          |              |                                  | 1054-823-2000     | ----          |              |   |
| 20   | NEEDLE VALVE*      | 1062-818-2000     | <b>222097</b> | <b>10.09</b> | L                                | 1062-818-2000     | <b>222097</b> | <b>10.09</b> | L |
| 21   | GASKET*            | 1202-822-2000*    | <b>222180</b> | <b>6.35</b>  | L                                | 1202-822-2000*    | <b>222180</b> | <b>6.35</b>  | L |
| 22   | JET BLOCK 1.6 VS   | 1605-829-2101-1.6 | ----          |              |                                  | 1605-853-2101-1.6 | ----          |              |   |
| 22A. | JET BLOCK 1.8 VS   | 1605-829-2101-1.8 | ----          |              |                                  | 1605-853-2102-1.8 | ----          |              |   |
| 22B. | JET BLOCK 2 VS     | 1605-829-2101-2.0 | ----          |              |                                  | 1605-853-2102-2.0 | <b>222164</b> | <b>44.93</b> | L |
| 23   | U-RING*            | 0903-809-6000*    | ----          |              |                                  | 0903-809-6000*    | ----          |              |   |
| 24   | COIL SPRING        | 1290-050-2000     | ----          |              |                                  |                   |               |              |   |
| 25   | STOP SCREW         | 1034-824-7000     | ----          |              |                                  |                   |               |              |   |
| 26   | LEVER PIN          | 1480-049-2004     | <b>222182</b> | <b>5.19</b>  | L                                |                   |               |              |   |
| 27   | MAIN JET           | N424-36-QQQ       | ----          |              |                                  |                   |               |              |   |
| 28   | O-RING             | 0901-055-6000*    | ----          |              |                                  |                   |               |              |   |
| 29   | COLLAR             | 1118-935-7000     | ----          |              |                                  |                   |               |              |   |
| 30   | SCREEN*            | 2009-811-2100     | ----          |              |                                  |                   |               |              |   |
| 34   | DIAPHRAGM*         | 1201-825-2000*    | <b>222177</b> | <b>9.09</b>  | L                                |                   |               |              |   |
| 36   | FUEL PUMP COMP.    | 1000-983-0400     | ----          |              |                                  |                   |               |              |   |
| 37   | O-RING*            | 0901-841-6000*    | <b>222183</b> | <b>10.64</b> | L                                |                   |               |              |   |
| 38   | COLLAR             | 1118-964-7000     | ----          |              |                                  |                   |               |              |   |
| 39   | GASKET*            | 1202-851-2000*    | <b>222181</b> | <b>18.20</b> | L                                |                   |               |              |   |
| 42   | SCREW              | 4129-826-1900     | ----          |              |                                  |                   |               |              |   |
| 46   | SPRING WASHER      | 0303-801-1000     | ----          |              |                                  |                   |               |              |   |
| 47   | LOCKNUT            | 0208-807-1000     | ----          |              |                                  |                   |               |              |   |
| 48A. | THR. LEVER A       | 1026-952-2000     | ----          |              |                                  |                   |               |              |   |
| 48B. | THR. LEVER B       | 1026-949-2001     | <b>222168</b> | <b>24.15</b> | L                                |                   |               |              |   |

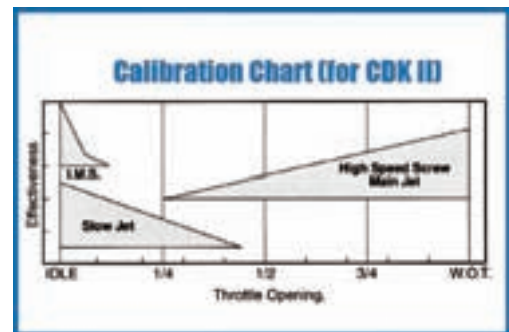

Throttle Linkages

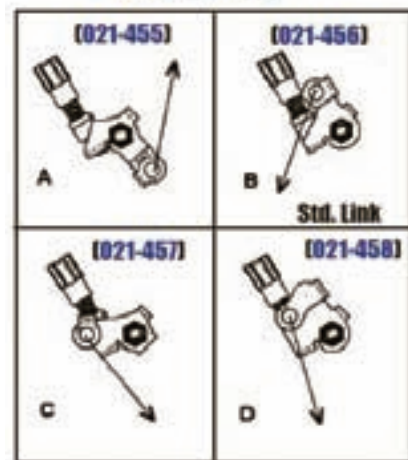

NOTE: The arrows show you throttle cable direction.

- accessories
- towables
- body
- controls
- electrical
- driveline
- engine
- fuel & intake**
- chemicals
- tie downs
- tools
- towing & loading

MARINE



| NO.  | DESCRIPTION           | KEIHIN NO.    | KEIHIN CDKII |       |   | KEIHIN CDKII W/ ACCELERATOR PUMP |        |         |
|------|-----------------------|---------------|--------------|-------|---|----------------------------------|--------|---------|
|      |                       |               | PART #       |       |   | KEIHIN NO.                       | PART # |         |
| 48C. | THR. LEVER C          | 1026-951-2000 | 222169       | 27.25 | L | 1026-951-2000                    | 222169 | 27.25 L |
| 48D. | THR. LEVER D          | 1026-950-2000 | ----         |       |   | 1026-950-2000                    | ----   |         |
| 49   | CAP                   | 1096-047-2001 | ----         |       |   | 1096-047-2001                    | ----   |         |
| 50   | SCREW                 | 4110-812-1000 | ----         |       |   | 4110-812-1000                    | ----   |         |
| 51   | U-RING                | N/A           | ----         |       |   | W9353-40000                      | ----   |         |
| 52   | COVER, ACCP.          | N/A           | ----         |       |   | 1230-845-2000                    | ----   |         |
| 53   | COIL SPRING, ACCP     | N/A           | ----         |       |   | 1290-987-2000                    | ----   |         |
| 54   | SCREW, ACCP           | N/A           | ----         |       |   | 0135-823-1000                    | ----   |         |
| 55   | RUBBER HOSE           | N/A           | ----         |       |   | 0804-A81-0000                    | ----   |         |
| 56   | ZIP TIE               | N/A           | ----         |       |   | W3756-001-9900                   | ----   |         |
| 57   | DIAPHRAGM COMP, ACCP  | N/A           | ----         |       |   | 1201-829-2102                    | ----   |         |
| 58   | COIL SPRING, ACCP     | N/A           | ----         |       |   | 1305-A06-2000                    | ----   |         |
| 59   | COIL SPRING, ACCP CAM | N/A           | ----         |       |   | 1305-990-2000                    | ----   |         |
| 59A. | COIL SPRING, ACCP CAM | N/A           | ----         |       |   | 1305-991-2000<br>(+80%)          | ----   |         |
| 60   | ACCP. CAM             | N/A           | ----         |       |   | 1100-886-7000                    | ----   |         |
| 60A. | ACCP. CAM             | N/A           | ----         |       |   | 1100-889-7000<br>(-20% VOLUME)   | ----   |         |
| 61   | COLLAR                | N/A           | ----         |       |   | 1118-A11-7000                    | ----   |         |
| 62   | PLATE                 | N/A           | ----         |       |   | 1026-986-2000                    | ----   |         |
| 63   | PLAIN WASHER          | N/A           | ----         |       |   | 0301-862-1000                    | ----   |         |
| 64   | SPRING                | N/A           | ----         |       |   | 0303-801-1000                    | ----   |         |
| 65   | NUT                   | N/A           | ----         |       |   | 0208-801-1000                    | ----   |         |
| 66   | BOOTS                 | N/A           | ----         |       |   | 1028-054-7000                    | ----   |         |

### CDK CARBURETOR REBUILD KITS

Includes all parts necessary to completely rebuild the Keihin CDK carburetors to factory specifications. Made in Japan.

| DESCRIPTION   | PART # |       |   |
|---------------|--------|-------|---|
| CDK28MM       | 222190 | 51.00 | L |
| CDK38,40,42MM | 222191 | 77.95 | J |



### FUEL PUMP REBUILD KIT

Includes all parts necessary to completely rebuild the Keihin Fuel Pump to factory specifications. Replaces internal parts (gaskets, diaphragms and check valves) on Kawasaki 49040-3706 Fuel Pump. Made in Japan. See model application listing below for Kawasaki Jet Ski Watercraft.

| KAWASAKI PWC MODEL           | YEAR  | PART # |         |
|------------------------------|-------|--------|---------|
| JB650A1/A2 JET MATE          | 89-90 | 222162 | 26.46 L |
| JF650A1/A2/A3/A4/A5 X2       | 86-90 |        |         |
| JF650B1/B2 TANDEM SPORT (TS) | 89-90 |        |         |
| JS650A1/A2/A3/A4 SX          | 87-90 |        |         |



### CHOKE SHAFT BLOCK-OFF

CDKII choke plate block off.

| PART # |        |
|--------|--------|
| 222165 | 7.33 L |



- accessories
- towables
- body
- controls
- electrical
- driveline
- engine
- fuel & intake**
- chemicals
- tie downs
- tools
- towing & loading

MARINE





## CDKII PARTS & ACCESSORIES

### N424-35-XXX SLOW JETS

Nickel plated slow jets to prevent corrosion. Applications: CDK, CDKII 38 & 42 Watercraft Carburetors, Kawasaki OEM Jet-Ski with CDK Carburetors.



| SIZE | PART # |      |   |
|------|--------|------|---|
| #50  | 222133 | 4.67 | L |
| #52  | 222134 | 4.67 | L |
| #55  | 222135 | 4.67 | L |
| #58  | 222136 | 4.67 | L |
| #60  | 222137 | 4.67 | L |
| #62  | 222138 | 4.67 | L |
| #65  | 222139 | 4.67 | L |
| #68  | 222140 | 4.67 | L |
| #70  | 222141 | 4.67 | L |
| #72  | 222142 | 4.67 | L |

| SIZE | PART # |      |   |
|------|--------|------|---|
| #75  | 222143 | 4.67 | L |
| #78  | 222144 | 4.67 | L |
| #80  | 222145 | 4.67 | L |
| #82  | 222146 | 4.67 | L |
| #85  | 222147 | 4.67 | L |
| #88  | 222148 | 4.67 | L |
| #90  | 222149 | 4.67 | L |
| #95  | 222151 | 4.67 | L |
| #98  | 222152 | 4.67 | L |

| SIZE | PART # |      |   |
|------|--------|------|---|
| #100 | 222153 | 4.67 | L |
| #102 | 222154 | 4.67 | L |
| #105 | 222155 | 4.67 | L |
| #108 | 222156 | 4.67 | L |
| #110 | 222157 | 4.67 | L |
| #112 | 222158 | 4.67 | L |
| #115 | 222159 | 4.67 | L |
| #118 | 222160 | 4.67 | L |
| #120 | 222161 | 4.67 | L |

### N424-36-XXX MAIN JETS

Nickel plated slow jets to prevent corrosion. Applications: CDK, CDKII 38 & 42 Watercraft Carburetors, Kawasaki OEM Jet-Ski with CDK Carburetors.



| SIZE | PART # |      |   |
|------|--------|------|---|
| #100 | 222098 | 7.14 | L |
| #102 | 222099 | 7.14 | L |
| #105 | 222100 | 7.14 | L |
| #108 | 222101 | 7.14 | L |
| #110 | 222102 | 7.14 | L |
| #112 | 222103 | 7.14 | L |
| #118 | 222105 | 7.14 | L |
| #120 | 222106 | 7.14 | L |
| #122 | 222107 | 7.14 | L |

| SIZE | PART # |      |   |
|------|--------|------|---|
| #132 | 222111 | 7.14 | L |
| #135 | 222112 | 7.14 | L |
| #138 | 222113 | 7.14 | L |
| #140 | 222114 | 7.14 | L |
| #142 | 222115 | 7.14 | L |
| #145 | 222116 | 7.14 | L |
| #150 | 222118 | 7.14 | L |
| #152 | 222119 | 7.14 | L |
| #155 | 222120 | 7.14 | L |

| SIZE | PART # |      |   |
|------|--------|------|---|
| #165 | 222124 | 7.14 | L |
| #168 | 222125 | 7.14 | L |
| #170 | 222126 | 7.14 | L |
| #172 | 222127 | 7.14 | L |
| #175 | 222128 | 7.14 | L |
| #180 | 222129 | 7.14 | L |
| #190 | 222131 | 7.14 | L |
| #195 | 222132 | 7.14 | L |
| #200 | 222132 | 7.14 | L |

| Pop-Off Pressure Chart |               |                        |       |       |
|------------------------|---------------|------------------------|-------|-------|
| Spring Force           | Spring Length | Needle Valve Size (mm) |       |       |
|                        |               | 1.6(Std)               | 1.8   | 2.0   |
| 70gr.(std)             | 11mm          | 24psi                  | 21psi | 18psi |
| 40gr.                  | 9.7mm         | 15psi                  | 13psi | 11psi |

- accessories
- towables
- body
- controls
- electrical
- driveline
- engine
- fuel & intake**
- chemicals
- tie downs
- tools
- towing & loading

MARINE



- accessories
- towables
- body
- controls
- electrical
- driveline
- engine
- fuel & intake**
- chemicals
- tie downs
- tools
- towing & loading

## BN CARBURETOR PARTS & ACCESSORIES

| SIZE  | PART # |        | SIZE   | PART #  |        |
|-------|--------|--------|--------|---------|--------|
| #30   | SMJ30  | 4.15 L | #92.5  | SMJ925  | 4.15 L |
| #32.5 | SMJ325 | 4.15 L | #95    | SMJ95   | 4.15 L |
| #35   | SMJ35  | 4.15 L | #97.5  | SMJ975  | 4.15 L |
| #37.5 | SMJ375 | 4.15 L | #100   | SMJ100  | 4.15 L |
| #40   | SMJ40  | 4.15 L | #102.5 | SMJ1025 | 4.15 L |
| #42.5 | SMJ425 | 4.15 L | #105   | SMJ105  | 4.15 L |
| #45   | SMJ45  | 4.15 L | #107.5 | SMJ1075 | 4.15 L |
| #47.5 | SMJ475 | 4.15 L | #110   | SMJ110  | 4.15 L |
| #50   | SMJ50  | 4.15 L | #112.5 | SMJ1125 | 4.15 L |
| #52.5 | SMJ525 | 4.15 L | #115   | SMJ115  | 4.15 L |
| #55   | SMJ55  | 4.15 L | #117.5 | SMJ1175 | 4.15 L |
| #57.5 | SMJ575 | 4.15 L | #120   | SMJ120  | 4.15 L |
| #60   | SMJ60  | 4.15 L | #122.5 | SMJ1225 | 4.15 L |
| #62.5 | SMJ625 | 4.15 L | #125   | SMJ125  | 4.15 L |
| #65   | SMJ65  | 4.15 L | #127.5 | SMJ1275 | 4.15 L |
| #67.5 | SMJ675 | 4.15 L | #130   | SMJ130  | 4.15 L |
| #70   | SMJ70  | 4.15 L | #132.5 | SMJ1325 | 4.15 L |
| #72.5 | SMJ725 | 4.15 L | #135   | SMJ135  | 4.15 L |
| #75   | SMJ75  | 4.15 L | #137.5 | SMJ1375 | 4.15 L |
| #77.5 | SMJ775 | 4.15 L | #140   | SMJ140  | 4.15 L |
| #80   | SMJ80  | 4.15 L | #142.5 | SMJ1425 | 4.15 L |
| #82.5 | SMJ825 | 4.15 L | #145   | SMJ145  | 4.15 L |
| #85   | SMJ85  | 4.15 L | #147.5 | SMJ1475 | 4.15 L |
| #87.5 | SMJ875 | 4.15 L | #150   | SMJ150  | 4.15 L |
| #90   | SMJ90  | 4.15 L | #152.5 | SMJ1525 | 4.15 L |

| SIZE   | PART #  |        |
|--------|---------|--------|
| #155   | SMJ155  | 4.15 L |
| #157.5 | SMJ1575 | 4.15 L |
| #160   | SMJ160  | 4.15 L |
| #162.5 | SMJ1625 | 3.70 L |
| #165   | SMJ165  | 3.70 L |
| #167.5 | SMJ1675 | 4.15 L |
| #170   | SMJ170  | 4.15 L |
| #172.5 | SMJ1725 | 4.15 L |
| #175   | SMJ175  | 4.15 L |
| #177.5 | SMJ1775 | 4.15 L |
| #180   | SMJ180  | 4.15 L |
| #182.5 | SMJ1825 | 4.15 L |
| #185   | SMJ185  | 4.15 L |
| #187.5 | SMJ875  | 4.15 L |
| #190   | SMJ190  | 4.15 L |
| #195   | SMJ195  | 4.15 L |
| #200   | SMJ200  | 4.15 L |
| #205   | SMJ205  | 4.15 L |
| #210   | SMJ210  | 4.15 L |
| #215   | SMJ215  | 4.15 L |
| #220   | SMJ220  | 4.15 L |
| #230   | SMJ230  | 4.15 L |
| #240   | SMJ240  | 4.15 L |

### HIGH SPEED JETS N102.221

Applications:  
Personal Watercraft (High Speed Jets) Super BN 38, BN44, BN46, BN38I, BN40I, BN44I, BN46I



| SIZE  | PART # |        |
|-------|--------|--------|
| #30   | 222016 | 4.15 L |
| #32.5 | 222017 | 4.15 L |
| #35   | 222018 | 4.15 L |
| #37.5 | 222019 | 4.15 L |
| #40   | 222020 | 4.15 L |
| #42.5 | 222021 | 4.15 L |
| #45   | 222022 | 4.15 L |
| #47.5 | 222023 | 4.15 L |
| #50   | 222024 | 4.15 L |
| #52.5 | 222025 | 4.15 L |
| #55   | 222026 | 4.15 L |
| #57.5 | 222027 | 4.15 L |
| #60   | 222028 | 4.15 L |
| #62.5 | 222029 | 4.15 L |
| #65   | 222030 | 4.15 L |
| #67.5 | 222031 | 4.15 L |
| #70   | 222032 | 4.15 L |
| #72.5 | 222033 | 4.15 L |

| SIZE   | PART # |        |
|--------|--------|--------|
| #75    | 222034 | 4.15 L |
| #77.5  | 222035 | 4.15 L |
| #80    | 222036 | 4.15 L |
| #82.5  | 222037 | 4.15 L |
| #85    | 222038 | 4.15 L |
| #87.5  | 222039 | 4.15 L |
| #90    | 222040 | 4.15 L |
| #92.5  | 222041 | 4.15 L |
| #95    | 222042 | 4.15 L |
| #97.5  | 222043 | 4.15 L |
| #100   | 222044 | 4.15 L |
| #102.5 | 222045 | 4.15 L |
| #105   | 222046 | 4.15 L |
| #107.5 | 222047 | 4.15 L |
| #110   | 222048 | 4.15 L |
| #112.5 | 222049 | 4.15 L |
| #115   | 222050 | 4.15 L |
| #117.5 | 222051 | 4.15 L |

| SIZE   | PART # |        |
|--------|--------|--------|
| #120   | 222052 | 4.15 L |
| #122.5 | 222053 | 4.15 L |
| #125   | 222054 | 4.15 L |
| #127.5 | 222055 | 4.15 L |
| #130   | 222056 | 4.15 L |
| #132.5 | 222057 | 4.15 L |
| #135   | 222058 | 4.15 L |
| #137.5 | 222059 | 4.15 L |
| #140   | 222060 | 4.15 L |
| #142.5 | 222061 | 4.15 L |
| #145   | 222062 | 4.15 L |
| #147.5 | 222063 | 4.15 L |
| #150   | 222064 | 4.15 L |
| #155   | 222065 | 3.95 L |
| #160   | 222066 | 4.15 L |

### SLOW SPEED JETS N100.606

Applications:  
Slow Speed Jet on BN Personal Watercraft Carburetors. Super BN 38, BN44, BN46, BN38I, BN40I, BN44I, BN46I





## BN CARBURETOR PARTS & ACCESSORIES

### BN (ROUND PUMP CARB TYPE)

#### THROTTLE SHAFT REBUILD KITS

Kits include butterfly valve, shaft seals, screws and instructions.



| CARB | SIZE | MIKUNI #   | PART # |         |
|------|------|------------|--------|---------|
| BN38 | 38   | MK-BN038TV | 222089 | 53.81 L |
| BN44 | 44   | MK-BN044TV | 222090 | 53.81 L |
| BN46 | 46   | MK-BN046TV | 222091 | 53.81 L |

#### NEEDLE VALVE SETS FOR BN34/38/44

Genuine Mikuni replacements. Set includes metal tip needle valve and screw-in type needle valve seat. Washer not included.



| SIZE | MIKUNI #                 | PART # |         |
|------|--------------------------|--------|---------|
| 1.5  | VM26/185-1.5 (VITON TIP) | 222001 | 33.26 L |

#### NEEDLE VALVE SETS WITH VITON TIP FOR BN38/44

Genuine Mikuni replacements. Set includes viton tip needle valve with clip and screw-in type needle valve seat. Washer not included.



| SIZE | MIKUNI #      | PART # |         |
|------|---------------|--------|---------|
| 1.5  | 786-15005-1.5 | 222008 | 25.35 L |
| 2    | 786-15005-2.0 | 222009 | 25.35 L |
| 2.5  | 786-15005-2.5 | 222010 | 25.35 L |

### BN (SQUARE CARB TYPE)

#### POP-OFF PUMP

Mikuni's Pop-Off pump features a precision dial gauge. This allows accurate testing and adjustment of pop-off spring pressure. Sold each. Order by gauge reading needed.

| DESCRIPTION   | MIKUNI #     | PART # |         |
|---------------|--------------|--------|---------|
| 30 LB. GAUGE  | MK-BN-PMP30  | MKBN   | 68.95 B |
| 100 LB. GAUGE | MK-BN-PMP100 | 222015 | 57.00 B |



#### NEEDLE VALVE SETS FOR SUPER BN38/44/46

Genuine Mikuni replacements. Set includes solid needle valve with viton tip and clip, needle valve seat and o-ring.

| SIZE | MIKUNI #      | PART # |         |
|------|---------------|--------|---------|
| 1.5  | 786-35015-1.5 | 222003 | 25.35 L |
| 1.8  | 786-35015-1.8 | 222007 | 25.35 L |
| 2    | 786-35015-2.0 | 222004 | 25.35 L |
| 2.3  | 786-35015-2.3 | 222005 | 25.35 L |
| 2.5  | 786-35015-2.5 | 222006 | 25.35 L |



#### NEEDLE VALVE ARM SPRINGS

Available in different spring rates to vary pop-off pressure.

| DESCRIPTION | COLOR        | MIKUNI #    | PART # |        |
|-------------|--------------|-------------|--------|--------|
| 65 GRAMS    | SHINY SILVER | 730-03030   | 222084 | 3.41 L |
| 80 GRAMS    | BLACK        | 730-03033   | 222085 | 3.41 L |
| 95 GRAMS    | DULL SILVER  | 730-03027-T | 222086 | 3.41 L |



222084



222085



222086

#### NEEDLE VALVE SETS FOR BN46I

Genuine Mikuni replacements. Set includes solid needle valve with viton tip and clip, needle valve seat and o-ring.

| SIZE | MIKUNI #      | PART # |         |
|------|---------------|--------|---------|
| 1.5  | 786-35018-1.5 | 222014 | 25.35 L |
| 1.8  | 786-35018-1.8 | 222011 | 25.35 L |
| 2    | 786-35018-2.0 | 222012 | 25.35 L |
| 2.5  | 786-35018-2.5 | 222013 | 25.35 L |



- accessories
- towables
- body
- controls
- electrical
- driveline
- engine
- fuel & intake**
- chemicals
- tie downs
- tools
- towing & loading

# MARINE



## SUPER BN (SQUARE PUMP BODY)

### SUPER BN EXPLODED VIEW

- accessories
- towables
- body
- controls
- electrical
- driveline
- engine
- fuel & intake**
- chemicals
- tie downs
- tools
- towing & loading

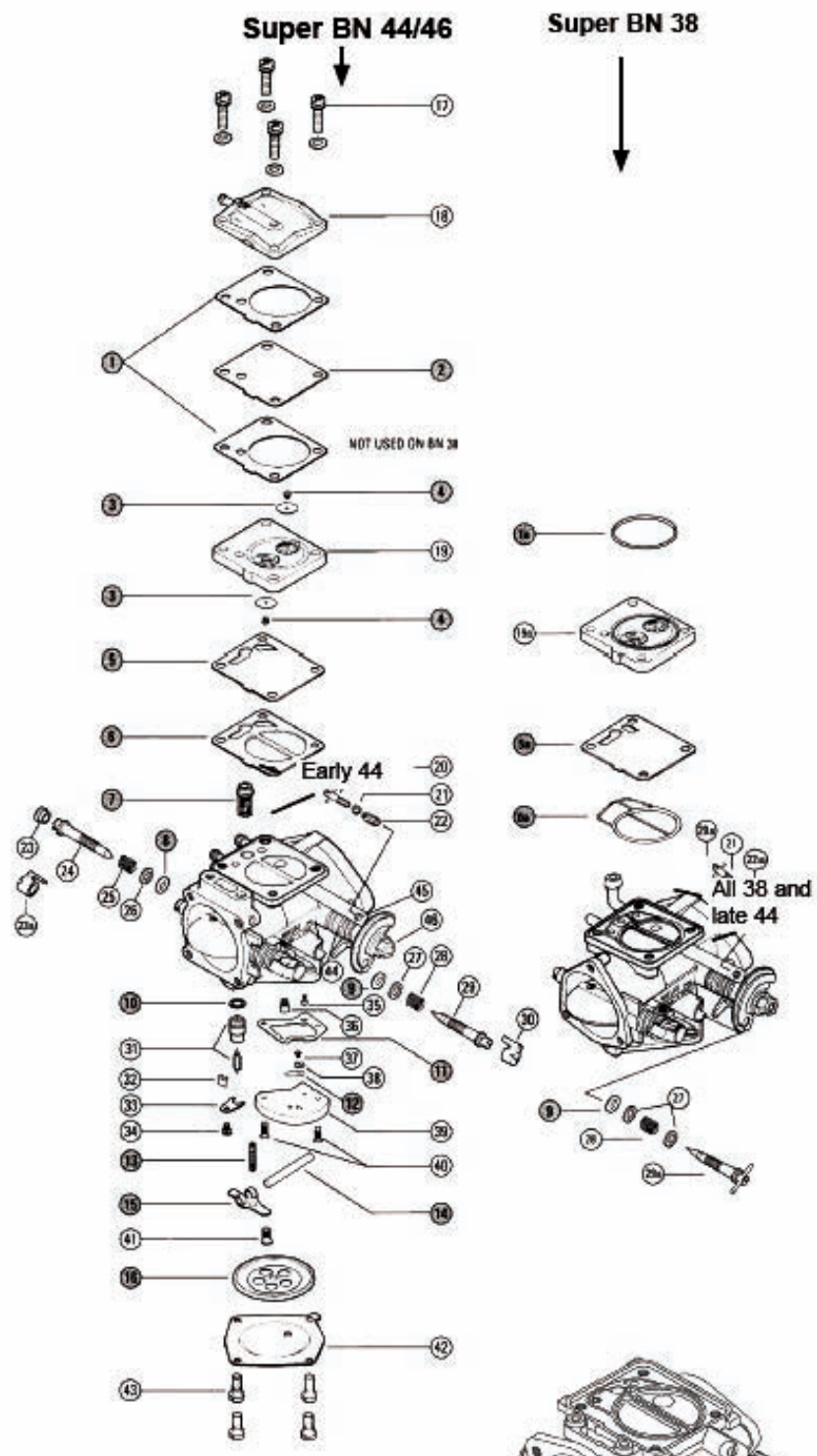

Block Off Plate - BN34/126  
 Primer Fitting - VM34/181  
 90° Elbow - DF44 - 2/70

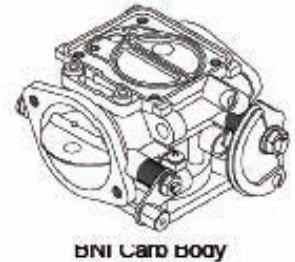



## SUPER BN (SQUARE PUMP BODY)

### SUPER BN CARBURETOR REBUILD KIT

MK-BN38/44SPR - For Super BN38, BN44, and BN38I, BN40I Square Pump Styles. Rebuild Kit includes parts 1 through 16 to rebuild one carburetor.

| NO. | DESCRIPTION  | MIKUNI #  | PART #                |
|-----|--|-----------|-----------------------|
| 1   | GASKET, PUMP (BLACK FIBER)                             | BN38/547  | ----                  |
| 1A. | O-RING, PUMP BODY                                      | 616-72001 | ----                  |
| 2   | DIAPHRAGM, PUMP (CLEAR)                                | BN34/97   | ----                  |
| 3   | CHECK VALVE (CLEAR)-2                                  | BN34/124  | ----                  |
| 4   | GROMMET, CHECK VALVE- 2                                | BN34/125  | ----                  |
| 5   | DIAPHRAGM, DAMPER (BLACK RUBBER) (BN44 ONLY)           | BN34/100  | ----                  |
| 5A. | DIAPHRAGM, DAMPER (BLACK RUBBER) (BN38 AND LATER BN44) | BN34/129  | ----                  |
| 6   | GASKET, DAMPER (BLACK) (BN44)                          | BN34/100  | ----                  |
| 6A. | O-RING (BN38 AND LATER BN44)                           | 616-92007 | ----                  |
| 7   | FILTER   | BN44/146  | ----                  |
| 8   | O-RING, HI SPEED                                       | B30/305   | ----                  |
| 9   | O-RING, LOW SPEED                                      | MD12/16   | ----                  |
| 10  | O-RING, NEEDLE VALVE                                   | KV/10     | ----                  |
| 11  | GASKET, VALVE BODY                                     | BN34/123  | ----                  |
| 12  | CHECK VALVE (CLEAR)                                    | BN34/107  | <b>222093 1.47</b> L  |
| 13  | SPRING, ARM (115 GRAMS)                                | 730-03027 | <b>222087 3.41</b> L  |
| 14  | PIN, ARM   | VM30/97   | ----                  |
| 15  | ARM (STAINLESS)  | BN38/534  | ----                  |
| 16  | DIAPHRAGM ASSEMBLY, MAIN                               | BN44/145  | <b>222074 19.64</b> L |

### SUPER BN REPLACEMENT PARTS

(Items 17-43 shown for reference only. Not included in Rebuild Kit)

|     |   |                |                       |
|-----|---|----------------|-----------------------|
| 17  | SCREW WITH WASHER, STAINLESS-4            | BN34/120-30    | <b>222071 3.06</b> L  |
| 18  | COVER, PUMP (UNPAINTED)                   | BN34/95B       | <b>222076 20.22</b> L |
|     | COVER, PUMP (BLACK)                       | 999-642-002-1A | <b>222077 20.22</b> L |
|     | COVER, PUMP (SILVER)                      | 999-642-002-1B | <b>222078 20.15</b> L |
|     | COVER, PUMP (RED)                         | 999-642-002-1C | ----                  |
| 18A | FUEL PUMP BLOCK OFF PLATE                 | BN34/126       | <b>222075 20.22</b> L |
| 19  | BODY ASSEMBLY, PUMP (BN44 ONLY)           | BN34/98        | ----                  |
| 19A | BODY ASSEMBLY, PUMP (BN38 AND LATER BN44) | BN34/128       | ----                  |
| 20  | STOP SCREW, IDLE (BN44 ONLY)              | BN34/109       | ----                  |

| NO.  | DESCRIPTION                               | MIKUNI #       | PART #                |
|------|---|----------------|-----------------------|
| 20A  | STOP SCREW, IDLE (BN38 AND LATER BN44)    | BN34/82        | ----                  |
| 21   | WASHER, (ALUMINUM)                        | BN38/39        | <b>222072 1.44</b> L  |
| 22   | SPRING, IDLE (BN44 ONLY)                  | BN38/341       | <b>222092 2.00</b> L  |
| 22A  | SPRING, IDLE (BN38 AND LATER BN44)        | BN38/344       | <b>222081 1.10</b> L  |
| 23   | CAP (BN44 ONLY)                           | BN26/03        | ----                  |
| 23A. | CAP WITH TAB (BN38 AND LATER BN44)        | BN44/118       | ----                  |
| 24   | ADJUSTER, HISPEED                         | 604-25017      | <b>222080 7.62</b> L  |
| 24A  | ADJUSTER, HISPEED                         | BN44/167       | ----                  |
| 25   | SPRING, HISPEED                           | BN38/344       | <b>222081 1.10</b> L  |
| 26   | WASHER, HISPEED (ALUMINUM)                | BN38/39        | <b>222072 1.44</b> L  |
| 27   | WASHER, LOWSPEED (ALUMINUM)               | BN38/172       | <b>222073 1.44</b> L  |
| 28   | SPRING, LOW SPEED                         | BN38/343       | <b>222083 1.10</b> L  |
| 29   | ADJUSTER, LOW SPEED (BN44)                | 604-26008      | <b>222082 7.62</b> L  |
| 29A. | ADJUSTER, LOW SPEED (BN38 AND LATER BN44) | BN38/477       | ----                  |
| 29B  | ADJUSTER, LOW SPEED                       | BN38/166       | ----                  |
| 30   | CAP                                       | BN44/118       | ----                  |
| 31   | NEEDLE VALVE ASSEMBLY                     | 786-35015-1.5  | <b>222003 25.35</b> L |
| 32   | SPRING CLIP, N. V.                        | VM15/285       | ----                  |
| 33   | PLATE, N. V. RETAINER                     | BN34/117-GG    | ----                  |
| 34   | SCREW WITH WASHER                         | CW2=0307-G     | <b>222095 1.47</b> L  |
| 35   | JET, SLOW SPEED                           | N100.606       | ----                  |
| 36   | JET, HIGH SPEED                           | N102.221       | ----                  |
| 37   | SCREW                                     | BV15/121-05-GG | ----                  |
| 38   | PLATE, VALVE                              | BN34/108-GG    | ----                  |
| 39   | VALVE BODY ASSEMBLY                       | BN44/165       | ----                  |
| 40   | SCREW, 4X14MM                             | C5-0414-G      | <b>222094 0.80</b> L  |
| 41   | SCREW, 3X8MM                              | C6-0308-G      | <b>222070 0.79</b> L  |
| 42   | COVER, STAINLESS                          | BN44/147       | ----                  |
| 43   | SCREW WITH WASHER, STAINLESS-4            | MCWS-0512      | <b>222069 2.20</b> L  |
| 44   | SPRING (NOT SHOWN IN DRAWING)             | BN34/110       | ----                  |
| 45   | BUSHING                                   | BN34/111       | ----                  |
| 46   | NUT                                       | B40I/35        | ----                  |

accessories

towables

body

controls

electrical

driveline

engine

**fuel & intake**

chemicals

tie downs

tools

towing & loading

MARINE



## BN461 (SQUARE CARB TYPE)

### BN461 EXPLODED VIEW

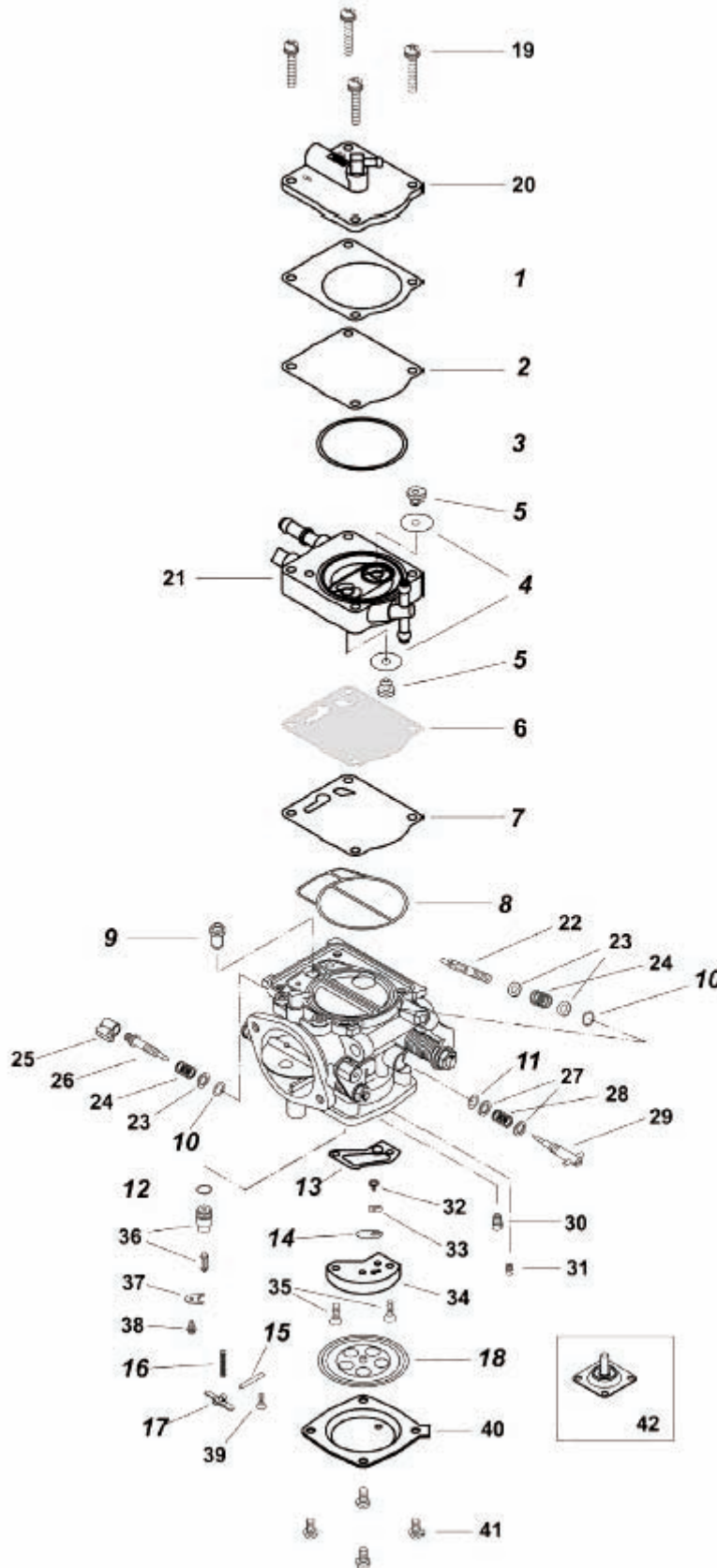

- accessories
- towables
- body
- controls
- electrical
- driveline
- engine
- fuel & intake**
- chemicals
- tie downs
- tools
- towing & loading

MARINE



## BN461 (SQUARE CARB TYPE)

**SUPER BN CARBURETOR REBUILD KIT** MK-BN461 and MK-BN441 Yamaha. Rebuild Kit includes parts 1-18.

| NO.  | DESCRIPTION   | MIKUNI #       | PART #        |              |   |
|--|---|----------------|---------------|--------------|---|
| 1  | GASKET, PUMP  | BN461/13       | ----          |              |   |
| 2  | DIAPHRAGM, PUMP (CLEAR)                               | BN461/14       | ----          |              |   |
| 3  | O-RING  | 616-73002      | ----          |              |   |
| 4  | CHECK VALVE (2)                                       | BN461/11       | ----          |              |   |
| 5  | GROMMET (2)   | BN34/125       | ----          |              |   |
| 6  | DIAPHRAGM, DAMPER                                     | BN461/34       | ----          |              |   |
| 7  | DIAPHRAGM, DAMPER (CLEAR)                             | BN461/15       | ----          |              |   |
| 8  | O-RING  | 616-73003      | ----          |              |   |
| 9  | FILTER, FUEL  | BN44/146       | ----          |              |   |
| 10   | O-RING, HI SPEED (2)                                  | B30/305        | ----          |              |   |
| 11   | O-RING, LOW SPEED                                     | MD12/16        | ----          |              |   |
| 12   | O-RING, NEEDLE VALVE                                  | KV/10          | ----          |              |   |
| 13   | GASKET, VALVE BODY                                    | BN34/123       | ----          |              |   |
| 14   | CHECK VALVE (CLEAR)                                   | BN34/107       | <b>222093</b> | <b>1.47</b>  |   |
| 15   | PIN, ARM  | VM30/97        | ----          |              |   |
| 16   | SPRING, ARM (95 GRAMS)                                | 730-03034      | ----          |              |   |
| 17   | ARM (STAINLESS)                                       | BN38/534       | ----          |              |   |
| 18   | DIAPHRAGM ASSEMBLY, MAIN                              | BN44/145       | <b>222074</b> | <b>19.64</b> | L |
| <b>BN461 REPLACEMENT PARTS</b> (Items 19-42 shown for reference only. Not included in Rebuild Kit) |   |                |               |              |   |
| 19   | SCREW WITH WASHER (4)** (SEE **TIGHTENING TORQUE)     | BN34/120-35    | ----          |              |   |
| 20   | COVER, PUMP   | BN461/XX       | ----          |              |   |
| 21   | BODY ASSEMBLY, PUMP                                   | BN46/49        | ----          |              |   |
| 22   | STOP SCREW, IDLE                                      | BN38/40        | ----          |              |   |
| 23   | WASHER, ALUMINUM, (3) HI SPEED (1) AND STOP SCREW (2) | BN38/39        | <b>222072</b> | <b>1.44</b>  | L |
| 24   | SPRING (2)  | BN38/344       | ----          |              |   |
| 25   | CAP, HI SPEED ADJUSTER                                | 999-904-006    | <b>222081</b> | <b>1.10</b>  | L |
| 26   | ADJUSTER, HI SPEED                                    | 604-25017      | <b>222080</b> | <b>7.62</b>  | L |
| 27   | WASHER, LOW SPEED (ALUMINUM) (2)                      | BN38/172       | <b>222073</b> | <b>1.44</b>  | L |
| 28   | SPRING, LOW SPEED                                     | BN38/343       | <b>222083</b> | <b>1.10</b>  | L |
| 29   | ADJUSTER, LOW SPEED                                   | BN38/477       | ----          |              |   |
| 30   | JET, HIGH SPEED                                       | N102.221       | ----          |              |   |
| 31   | JET, SLOW SPEED                                       | N100.606       | ----          |              |   |
| 32   | SCREW   | BV15/121-05-GG | ----          |              |   |
| 33   | PLATE, VALVE  | BN34/108-GG    | ----          |              |   |
| 34   | VALVE BODY ASSEMBLY                                   | BN44/165       | ----          |              |   |
| 35   | SCREW 4 X 14MM (2)                                    | C5=0414-G      | <b>222095</b> | <b>1.47</b>  | L |
| 36   | NEEDLE VALVE ASSEMBLY                                 | 786-35018-1.8  | <b>222007</b> | <b>25.35</b> | L |
| 37   | PLATE, NEEDLE VALVE RETAINER                          | ----           | ----          |              |   |
| 38   | SCREW WITH WASHER 3 X 7MM                             | CW2=0307-G     | <b>222094</b> | <b>0.80</b>  | L |
| 39   | SCREW 3 X 8MM   | C6=0308-G      | <b>222070</b> | <b>0.79</b>  | L |
| 40   | COVER (STAINLESS)                                     | BN44/147       | ----          |              |   |
| 41   | SCREW, 5 X 14MM (4) ** SEE **TIGHTENING TORQUE)       | C2S=0514       | <b>222096</b> | <b>1.42</b>  | L |
| 42   | DIAPHRAGM, ACCELERATOR PUMP                           | BN40/22        | ----          |              |   |

\*\*TIGHTENING TORQUE:

PART NO. 19: 4.5 N/M (45 KG/CM), PART NO. 41: 3.5 N/M (35 KG/CM)

accessories

towables

body

controls

electrical

driveline

engine

**fuel & intake**

chemicals

tie downs

tools

towing & loading

**MARINE**



## PWC CARBURETOR REBUILD KITS



### CARBURETOR KIT

Fits wide range of 38-44mm Keihin™ carbs found on PWC. Includes Viton™ tipped inlet needle.

| PART # |         |
|--------|---------|
| 837702 | 43.95 L |



### CARBURETOR KIT

Fits Keihin™ 28mm carbs. Includes Viton™ tipped inlet needle.

| PART # |         |
|--------|---------|
| 837701 | 31.95 L |



### CARBURETOR KIT

Fits Mikuni™ Super BN 34mm / 38mm / 44mm / 46mm

| PART # |         |
|--------|---------|
| 837700 | 33.95 L |



### CARBURETOR KIT

Fits Mikuni™ BN series carbs found on early Yamaha™, Kawasaki™ PWC with round style pump chamber.

| PART # |         |
|--------|---------|
| 837704 | 15.95 L |



### CARBURETOR KIT

Fits Mikuni™ Super BNI With larger pump chamber Found on: Sea Doo™ 2000-02 XP, RX, GTX Yamaha™ 1999-05 GP 800, GP1200R

| PART # |         |
|--------|---------|
| 837703 | 36.95 L |



### MIKUNI FUEL PUMP KIT

Replacement fuel pump kit for the Square type dual outlet Mikuni™ fuel Pump found on newer Bombardier™ Sea Doo™ and others.

| PART # |        |
|--------|--------|
| CG1454 | 5.95 L |



### MIKUNI FUEL PUMP KIT

Replacement fuel pump kit for the Round type dual outlet Mikuni™ fuel Pump found on many of the PWC including Sea Doo™, Polaris™, Kawasaki™ and others.

| PART # |        |
|--------|--------|
| CG1453 | 4.95 L |

- accessories
- towables
- body
- controls
- electrical
- driveline
- engine
- fuel & intake**
- chemicals
- tie downs
- tools
- towing & loading

# MARINE



## K&N STOCK FLAME ARRESTORS

The **K&N Flame Arrestor** makes the best air-filtration technology available for marine engine use. Marine application owners can experience the increased horsepower and engine protection provided by K&N's oiled cotton gauze and epoxied screen filter element. For high performance on the water, K&N Flame Arrestors will help you fly.



604401



## K&N RACE FLAME ARRESTORS

**K&N "Racing Only" Flame Arrestors** use an epoxied screen as a filter. They do not have cotton media and are intended for race use only. For non-racing use of your personal watercraft use regular K&N flame arrestors which come with K&N's oiled cotton media sandwiched between screen material. For high performance on the water, K&N Flame Arrestors will help you fly.



604402



604403



604407



604408

## K&N MARINE CARBURETOR ADAPTERS

**K&N Marine Carburetor Adapters** make connecting K&N flame arrestors to personal watercraft carburetors quick and easy. Add performance by replacing your restrictive factory airbox with a K&N flame arrestor and adapter.

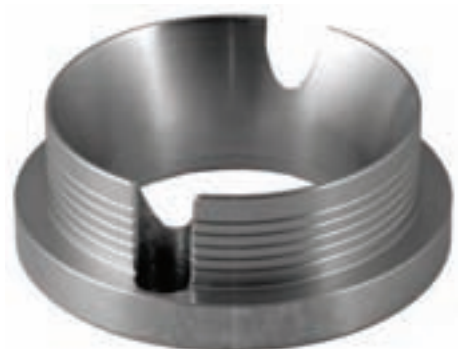

605187

- accessories
- towables
- body
- controls
- electrical
- driveline
- engine
- fuel & intake**
- chemicals
- tie downs
- tools
- towing & loading

MARINE

## K&N FLAME ARRESTORS

- accessories
- towables
- body
- controls
- electrical
- driveline
- engine
- fuel & intake**
- chemicals
- tie downs
- tools
- towing & loading

MARINE

| MAKE/MODEL           | YEAR  | STOCK PART # |       |   | RACE PART # |       |   | ADAPTER PART # |       |   |
|----------------------|-------|--------------|-------|---|-------------|-------|---|----------------|-------|---|
| <b>KAWASAKI</b>      |       |              |       |   |             |       |   |                |       |   |
| JS300                | 86-91 | 604396       | 88.39 | G | 604408      | 72.79 | G | 605189         | 85.29 | G |
| JS400                | 74-76 | 604396       | 88.39 | G | 604408      | 72.79 | G | 605189         | 85.29 | G |
| JS440                | 77-90 | 604396       | 88.39 | G | 604408      | 72.79 | G | 605189         | 85.29 | G |
| JS440                | 91-92 | 604396       | 88.39 | G | 604408      | 72.79 | G | 605187         | 93.19 | G |
| JS550 SX             | 91-95 | 604396       | 88.39 | G | 604408      | 72.79 | G | 605187         | 93.19 | G |
| JS550                | 82-85 | 604396       | 88.39 | G | 604408      | 72.79 | G | 605189         | 85.29 | G |
| JS550                | 86-90 | 604396       | 88.39 | G | 604408      | 72.79 | G | 605193         | 88.49 | G |
| JF650 TS             | 88-96 | 604401       | 71.39 | G | 604408      | 72.79 | G | 605187         | 93.19 | G |
| JF650 X2             | 89-90 | 604398       | 77.89 | G | 604408      | 72.79 | G | 605186         | 80.59 | G |
| JL650 SC             | 90-95 | 604396       | 88.39 | G | 604408      | 72.79 | G | 605187         | 93.19 | G |
| JS650 SX             | 86-93 | 604396       | 88.39 | G | 604408      | 72.79 | G | 605185         | 65.29 | G |
| JF650 X2             | 87-88 | 604398       | 77.89 | G | 604408      | 72.79 | G | 605186         | 80.59 | G |
| JH750 SS             | 92-97 | 604415       | 85.59 | G | 604408      | 72.79 | G | 605187         | 93.19 | G |
| JH750 Super Sport Xi | 93-94 | 604419       | 98.79 | G | 604402      | 70.89 | G | 605187         | 93.19 | G |
| JH750 Super Sport Xi | 95-97 | 604419       | 98.79 | G | 604408      | 72.79 | G | 605184         | 93.19 | G |
| JH750 Xi Sport       | 98-99 | 604419       | 98.79 | G | 604408      | 72.79 | G | 605184         | 93.19 | G |
| JH750 ZXi            | 95-97 | 604419       | 98.79 | G | 604408      | 72.79 | G | 605184         | 93.19 | G |
| JS750 SX             | 92-95 | 604415       | 85.59 | G | 604408      | 72.79 | G | 605187         | 93.19 | G |
| JS750 SXi            | 95    | 604419       | 98.79 | G | 604408      | 72.79 | G | 605184         | 93.19 | G |
| JS750 SXi            | 96-97 | 604419       | 98.79 | G | 604408      | 72.79 | G | 605188         | 80.39 | G |
| JS750 SXi Pro        | 98-99 | 604419       | 98.79 | G | 604408      | 72.79 | G | 605188         | 80.39 | G |
| JT750 STS            | 95-96 | 604419       | 98.79 | G | 604408      | 72.79 | G | 605184         | 93.19 | G |
| JT750 ST             | 94-95 | 604415       | 85.59 | G | 604408      | 72.79 | G | 605187         | 93.19 | G |
| JT750 STS            | 97-98 | 604419       | 98.79 | G | 604408      | 72.79 | G | 605184         | 93.19 | G |
| JH900 ZXi            | 95-97 | -----        |       |   | 604402      | 70.89 | G | 605184         | 93.19 | G |
| JT900 STS            | 01    | -----        |       |   | 604402      | 70.89 | G | 605184         | 93.19 | G |
| JT900 STX            | 97-01 | -----        |       |   | 604402      | 70.89 | G | 605184         | 93.19 | G |
| JT900 STS            | 99-00 | -----        |       |   | 604402      | 70.89 | G | 605184         | 93.19 | G |
| JH1100 ZXi           | 96-01 | -----        |       |   | 604402      | 70.89 | G | 605184         | 93.19 | G |
| JT1100 STX           | 97-99 | -----        |       |   | 604403      | 70.09 | G | 605184         | 93.19 | G |
| JT1100 STX           | 99    | -----        |       |   | 604402      | 70.89 | G | 605184         | 93.19 | G |
| JT1100 STX           | 99    | -----        |       |   | 604403      | 70.09 | G | 605184         | 93.19 | G |
| JT1100 STX           | 99    | -----        |       |   | 604406      | 65.49 | G | 605184         | 93.19 | G |
| <b>POLARIS</b>       |       |              |       |   |             |       |   |                |       |   |
| SL 650               | 92-95 | 604400       | 88.29 | G | 604403      | 70.09 | G | 605189         | 85.29 | G |
| SLH 700              | 01    | -----        |       |   | 604407      | 72.79 | G | -----          |       |   |
| SL 700/SLH           | 01    | -----        |       |   | 604407      | 72.79 | G | -----          |       |   |
| Virage 701           | 00-01 | -----        |       |   | 604407      | 72.79 | G | -----          |       |   |
| SL 750               | 93-95 | 604400       | 88.29 | G | 604403      | 70.09 | G | 605189         | 85.29 | G |
| SLT 750              | 94-95 | 604400       | 88.29 | G | 604403      | 70.09 | G | 605189         | 85.29 | G |
| SLT 780              | 96    | -----        |       |   | 604403      | 70.09 | G | 605189         | 85.29 | G |
| SLX 780              | 96    | -----        |       |   | 604403      | 70.09 | G | 605189         | 85.29 | G |
| SL 1050              | 97    | -----        |       |   | 604408      | 72.79 | G | 605187         | 93.19 | G |
| SLXH 1050            | 98    | -----        |       |   | 604408      | 72.79 | G | -----          |       |   |

## K&N FLAME ARRESTORS CONTINUED

| MAKE/MODEL                | YEAR  | STOCK PART # |       |   | RACE PART # |       |   | ADAPTER PART # |        |   |
|---------------------------|-------|--------------|-------|---|-------------|-------|---|----------------|--------|---|
| <b>SEA DOO</b>            |       |              |       |   |             |       |   |                |        |   |
| SP 580                    | 95-97 | 604397       | 86.79 | G | 604407      | 72.79 | G | 605190         | 97.49  | G |
| GT 581                    | 90-91 | 604397       | 86.79 | G | 604407      | 72.79 | G | 605190         | 97.49  | G |
| GTX 581                   | 92-94 | 604420       | 92.49 | G | 604402      | 70.89 | G | 605189         | 85.29  | G |
| GTX 581                   | 92-94 | 604420       | 92.49 | G | 604402      | 70.89 | G | 605190         | 97.49  | G |
| SP 581                    | 88-94 | 604397       | 86.79 | G | 604407      | 72.79 | G | 605190         | 97.49  | G |
| SPI 581                   | 88-97 | 604397       | 86.79 | G | 604407      | 72.79 | G | 605190         | 97.49  | G |
| SPX 581                   | 92    | 604420       | 92.49 | G | 604407      | 72.79 | G | 605189         | 85.29  | G |
| GTX 650                   | 92-94 | 604420       | 92.49 | G | 604402      | 70.89 | G | 605189         | 85.29  | G |
| GTX 650                   | 92-94 | 604420       | 92.49 | G | 604402      | 70.89 | G | 605190         | 97.49  | G |
| GTX 650                   | 95    | 604417       | 97.49 | G | 604402      | 70.89 | G | 605188         | 80.39  | G |
| GS 718                    | 97-98 | 604417       | 97.49 | G | 604402      | 70.89 | G | 605188         | 80.39  | G |
| GTI 718                   | 96    | 604417       | 97.49 | G | 604402      | 70.89 | G | 605188         | 80.39  | G |
| GTI 718                   | 97-98 | 604401       | 71.39 | G | 604402      | 70.89 | G | 605188         | 80.39  | G |
| GTI 718                   | 00-01 | 604401       | 71.39 | G | 604402      | 70.89 | G | 605188         | 80.39  | G |
| GTS 718                   | 92-96 | 604397       | 86.79 | G | 604407      | 72.79 | G | 605190         | 97.49  | G |
| GTS 718                   | 97    | 604397       | 86.79 | G | 604402      | 70.89 | G | 605188         | 80.39  | G |
| HX 718                    | 95-97 | ----         |       |   | 604402      | 70.89 | G | ----           |        |   |
| GSX 782                   | 96-97 | 604417       | 97.49 | G | 604402      | 70.89 | G | 605188         | 80.39  | G |
| GTX 782                   | 96-97 | 604417       | 97.49 | G | 604402      | 70.89 | G | 605188         | 80.39  | G |
| SPX 782                   | 93-94 | 604420       | 92.49 | G | 604407      | 72.79 | G | 605189         | 85.29  | G |
| SPX 782                   | 95    | 604417       | 97.49 | G | 604407      | 72.79 | G | 605188         | 80.39  | G |
| SPX 782                   | 96    | 604417       | 97.49 | G | 604407      | 72.79 | G | 605188         | 80.39  | G |
| SPX 782                   | 97-98 | 604417       | 97.49 | G | 604407      | 72.79 | G | 605188         | 80.39  | G |
| XP 782                    | 91-93 | 604420       | 92.49 | G | 604407      | 72.79 | G | 605189         | 85.29  | G |
| XP 782                    | 94    | 604417       | 97.49 | G | 604407      | 72.79 | G | 605189         | 85.29  | G |
| XP 782                    | 95    | 604417       | 97.49 | G | 604407      | 72.79 | G | 605188         | 80.39  | G |
| XP 782                    | 96-97 | 604417       | 97.49 | G | 604407      | 72.79 | G | 605188         | 80.39  | G |
| GSX Limited 949           | 98    | ----         |       |   | 604407      | 72.79 | G | ----           |        |   |
| GTX 951                   | 98    | ----         |       |   | 604407      | 72.79 | G | ----           |        |   |
| XP Limited 951            | 98    | ----         |       |   | 604407      | 72.79 | G | ----           |        |   |
| <b>YAMAHA</b>             |       |              |       |   |             |       |   |                |        |   |
| WJ500 Wave Jammer         | 88-90 | 604396       | 88.39 | G | 604408      | 72.79 | G | 605189         | 85.29  | G |
| WR500 WaveRunner          | 88-93 | 604396       | 88.39 | G | 604408      | 72.79 | G | 605189         | 85.29  | G |
| WRA650 WaveRunner III     | 90-96 | 604399       | 86.49 | G | ----        |       |   | 605197         | 131.89 | G |
| WRB650 WaveRunner VXR     | 91-95 | 604399       | 86.49 | G | ----        |       |   | 605197         | 131.89 | G |
| SJ650 Super Jet           | 90-93 | 604396       | 88.39 | G | 604408      | 72.79 | G | 605193         | 88.49  | G |
| WR650 WaveRunner          | 90-92 | 604396       | 88.39 | G | 604408      | 72.79 | G | 605193         | 88.49  | G |
| RA700 Wave Raider         | 94-95 | ----         |       |   | ----        |       |   | 605191         | 82.19  | G |
| RA700 Wave Raider         | 96-97 | 604401       | 71.39 | G | 604403      | 70.09 | G | 605199         | 91.29  | G |
| FX700 FX-1                | 94-95 | 604396       | 88.39 | G | ----        |       |   | 605193         | 88.49  | G |
| SJ700 Super Jet           | 94-95 | 604396       | 88.39 | G | 604407      | 72.79 | G | 605193         | 88.49  | G |
| SJ700 Super Jet           | 96-98 | ----         |       |   | 604402      | 70.89 | G | 605189         | 85.29  | G |
| WB700 Wave Blaster        | 93-95 | 604399       | 86.49 | G | ----        |       |   | 605197         | 131.89 | G |
| WRA700 WaveRunner         | 95-97 | 604399       | 86.49 | G | ----        |       |   | 605197         | 131.89 | G |
| WRB700 WaveRunner Pro VXR | 93-94 | 604399       | 86.49 | G | ----        |       |   | 605197         | 131.89 | G |
| WVT700 Wave Venture       | 95    | ----         |       |   | 604402      | 70.89 | G | 605191         | 82.19  | G |
| GP760 WaveRunner          | 98-99 | ----         |       |   | 604402      | 70.89 | G | 605194         | 87.39  | G |
| RA760 Wave Raider         | 96    | ----         |       |   | 604402      | 70.89 | G | 605193         | 88.49  | G |
| WB760 Wave Blaster        | 96-97 | ----         |       |   | 604402      | 70.89 | G | 605193         | 88.49  | G |
| XL760 WaveRunner          | 98-99 | 604419       | 98.79 | G | 604402      | 70.89 | G | 605199         | 91.29  | G |
| GP760 WaveRunner          | 97    | ----         |       |   | 604402      | 70.89 | G | 605194         | 87.39  | G |
| RA1100 Wave Raider        | 95-96 | ----         |       |   | 604402      | 70.89 | G | 605191         | 82.19  | G |
| WVT1100 Wave Venture      | 96-97 | ----         |       |   | 604402      | 70.89 | G | 605191         | 82.19  | G |
| GP1200 WaveRunner         | 97-98 | ----         |       |   | 604402      | 70.89 | G | 605193         | 88.49  | G |
| XL1200 WaveRunner         | 98    | ----         |       |   | 604402      | 70.89 | G | 605193         | 88.49  | G |

accessories

towables

body

controls

electrical

driveline

engine

fuel &amp; intake

chemicals

tie downs

tools

towing &amp; loading

MARINE



## K&N AIR AND OIL FILTERS

| MODEL                             | YEAR  | AIR FILTER |         | CUSTOM |         | OIL FILTER |         | CHROME OIL FILTER |         | COMMENTS       |
|-----------------------------------|-------|------------|---------|--------|---------|------------|---------|-------------------|---------|----------------|
| <b>HONDA</b>                      |       |            |         |        |         |            |         |                   |         |                |
| ARX1200N2 Aquatrax R-12           | 04-06 | -          | -       | -      | -       | KN204      | 15.49 G | KN204C            | 18.79 G |                |
| ARX1200N3 Aquatrax F-12           | 02-07 | -          | -       | -      | -       | KN204      | 15.49 G | KN204C            | 18.79 G |                |
| ARX1200T2 Aquatrax R-12X          | 03-07 | -          | -       | -      | -       | KN204      | 15.49 G | KN204C            | 18.79 G |                |
| ARX1200T3 Aquatrax F-12X          | 02-07 | -          | -       | -      | -       | KN204      | 15.49 G | KN204C            | 18.79 G |                |
| ARX1200T3D Aquatrax F-12X GPScape | 05-07 | -          | -       | -      | -       | KN204      | 15.49 G | KN204C            | 18.79 G |                |
| ARX1500N3 Aquatrax F-15           | 09    | -          | -       | -      | -       | KN204      | 15.49 G | KN204C            | 18.79 G |                |
| ARX1500T3 Aquatrax F-15X          | 08-09 | -          | -       | -      | -       | KN204      | 15.49 G | KN204C            | 18.79 G |                |
| ARX1500T3D Aquatrax F-15X GPScape | 08    | -          | -       | -      | -       | KN204      | 15.49 G | KN204C            | 18.79 G |                |
| <b>KAWASAKI</b>                   |       |            |         |        |         |            |         |                   |         |                |
| JS300                             | 86-91 | 604396     | 88.39 G | 605189 | 85.29 G | -          | -       | -                 | -       |                |
| JS300                             | 86-91 | 604408*    | 72.79 G | 605189 | 85.29 G | -          | -       | -                 | -       | *Race Specific |
| JS400                             | 74-76 | 604396     | 88.39 G | 605189 | 85.29 G | -          | -       | -                 | -       |                |
| JS400                             | 74-76 | 604408*    | 72.79 G | 605189 | 85.29 G | -          | -       | -                 | -       | *Race Specific |
| JS440                             | 77-90 | 604396     | 88.39 G | 605189 | 85.29 G | -          | -       | -                 | -       |                |
| JS440                             | 77-90 | 604408*    | 72.79 G | 605189 | 85.29 G | -          | -       | -                 | -       | *Race Specific |
| JS440                             | 91-92 | 604396     | 88.39 G | 605187 | 93.19 G | -          | -       | -                 | -       |                |
| JS440                             | 91-92 | 604408*    | 72.79 G | 605187 | 93.19 G | -          | -       | -                 | -       | *Race Specific |
| JS550 SX                          | 91-95 | 604396     | 88.39 G | 605187 | 93.19 G | -          | -       | -                 | -       |                |
| JS550 SX                          | 91-95 | 604408*    | 72.79 G | 605187 | 93.19 G | -          | -       | -                 | -       | *Race Specific |
| JS550                             | 82-85 | 604396     | 88.39 G | 605189 | 85.29 G | -          | -       | -                 | -       |                |
| JS550                             | 82-85 | 604408*    | 72.79 G | 605189 | 85.29 G | -          | -       | -                 | -       | *Race Specific |
| JS550                             | 86-90 | 604396     | 88.39 G | 605193 | 88.49 G | -          | -       | -                 | -       |                |
| JS550                             | 86-90 | 604408*    | 72.79 G | 605193 | 88.49 G | -          | -       | -                 | -       | *Race Specific |
| JF650 TS                          | 88-96 | 604401     | 71.39 G | 605187 | 93.19 G | -          | -       | -                 | -       |                |
| JF650 TS                          | 88-96 | 604408*    | 72.79 G | 605187 | 93.19 G | -          | -       | -                 | -       | *Race Specific |
| JF650 X2                          | 89-90 | 604398     | 77.89 G | 605186 | 80.59 G | -          | -       | -                 | -       |                |
| JF650 X2                          | 89-90 | 604408*    | 72.79 G | 605186 | 80.59 G | -          | -       | -                 | -       | *Race Specific |
| JL650 SC                          | 90-95 | 604396     | 88.39 G | 605187 | 93.19 G | -          | -       | -                 | -       |                |
| JL650 SC                          | 90-95 | 604408*    | 72.79 G | 605187 | 93.19 G | -          | -       | -                 | -       | *Race Specific |
| JS650 SX                          | 86-93 | 604396     | 88.39 G | 605185 | 65.29 G | -          | -       | -                 | -       |                |
| JS650 SX                          | 86-93 | 604408*    | 72.79 G | 605185 | 65.29 G | -          | -       | -                 | -       | *Race Specific |
| JF650 X2                          | 87-88 | 604398     | 77.89 G | 605186 | 80.59 G | -          | -       | -                 | -       |                |
| JF650 X2                          | 87-88 | 604408*    | 72.79 G | 605186 | 80.59 G | -          | -       | -                 | -       | *Race Specific |
| JH750 SS                          | 92-97 | 604408*    | 72.79 G | 605187 | 93.19 G | -          | -       | -                 | -       | *Race Specific |
| JH750 SS                          | 92-97 | 604415     | 85.59 G | 605187 | 93.19 G | -          | -       | -                 | -       | *Race Specific |
| JH750 Super Sport Xi              | 93-94 | 604402*    | 70.89 G | 605187 | 93.19 G | -          | -       | -                 | -       | *Race Specific |
| JH750 Super Sport Xi              | 93-94 | 604419     | 98.79 G | 605187 | 93.19 G | -          | -       | -                 | -       |                |
| JH750 Super Sport Xi              | 95-97 | 604408*    | 72.79 G | 605184 | 93.19 G | -          | -       | -                 | -       | *Race Specific |
| JH750 Super Sport Xi              | 95-97 | 604419     | 98.79 G | 605184 | 93.19 G | -          | -       | -                 | -       |                |
| JH750 Xi Sport                    | 98-99 | 604408*    | 72.79 G | 605184 | 93.19 G | -          | -       | -                 | -       | *Race Specific |
| JH750 Xi Sport                    | 98-99 | 604419     | 98.79 G | 605184 | 93.19 G | -          | -       | -                 | -       |                |
| JH750 ZXi                         | 95-97 | 604408*    | 72.79 G | 605184 | 93.19 G | -          | -       | -                 | -       | *Race Specific |
| JH750 ZXi                         | 95-97 | 604419     | 98.79 G | 605184 | 93.19 G | -          | -       | -                 | -       |                |
| JS750 SX                          | 92-95 | 604408*    | 72.79 G | 605187 | 93.19 G | -          | -       | -                 | -       | *Race Specific |
| JS750 SX                          | 92-95 | 604415     | 85.59 G | 605187 | 93.19 G | -          | -       | -                 | -       |                |
| JS750 SXi                         | 95    | 604408*    | 72.79 G | 605184 | 93.19 G | -          | -       | -                 | -       | *Race Specific |
| JS750 SXi                         | 95    | 604419     | 98.79 G | 605184 | 93.19 G | -          | -       | -                 | -       |                |
| JS750 SXi                         | 96-97 | 604408*    | 72.79 G | 605188 | 80.39 G | -          | -       | -                 | -       | *Race Specific |
| JS750 SXi                         | 96-97 | 604419     | 98.79 G | 605188 | 80.39 G | -          | -       | -                 | -       |                |
| JS750 SXi Pro                     | 98-99 | 604408*    | 72.79 G | 605188 | 80.39 G | -          | -       | -                 | -       | *Race Specific |
| JS750 SXi Pro                     | 98-99 | 604419     | 98.79 G | 605188 | 80.39 G | -          | -       | -                 | -       |                |
| JT750 STS                         | 95-96 | 604408*    | 72.79 G | 605184 | 93.19 G | -          | -       | -                 | -       | *Race Specific |
| JT750 STS                         | 95-96 | 604419     | 98.79 G | 605184 | 93.19 G | -          | -       | -                 | -       |                |
| JT750 ST                          | 94-95 | 604408*    | 72.79 G | 605187 | 93.19 G | -          | -       | -                 | -       | *Race Specific |
| JT750 ST                          | 94-95 | 604415     | 85.59 G | 605187 | 93.19 G | -          | -       | -                 | -       |                |
| JT750 STS                         | 97-98 | 604408*    | 72.79 G | 605184 | 93.19 G | -          | -       | -                 | -       | *Race Specific |
| JT750 STS                         | 97-98 | 604419     | 98.79 G | 605184 | 93.19 G | -          | -       | -                 | -       |                |
| JH900 ZXi                         | 95-97 | 604401     | 71.39 G | 605184 | 93.19 G | -          | -       | -                 | -       |                |
| JH900 ZXi                         | 95-97 | 604402*    | 70.89 G | 605184 | 93.19 G | -          | -       | -                 | -       | *Race Specific |
| JT900 STS                         | 01    | 604401     | 71.39 G | 605184 | 93.19 G | -          | -       | -                 | -       |                |
| JT900 STS                         | 01    | 604402*    | 70.89 G | 605184 | 93.19 G | -          | -       | -                 | -       | *Race Specific |
| JT900 STX                         | 97-01 | 604401     | 71.39 G | 605184 | 93.19 G | -          | -       | -                 | -       |                |
| JT900 STX                         | 97-01 | 604402*    | 70.89 G | 605184 | 93.19 G | -          | -       | -                 | -       | *Race Specific |
| JT900 STS                         | 99-00 | 604401     | 71.39 G | 605184 | 93.19 G | -          | -       | -                 | -       |                |
| JT900 STS                         | 99-00 | 604402*    | 70.89 G | 605184 | 93.19 G | -          | -       | -                 | -       | *Race Specific |
| JH1100 ZXi                        | 96-01 | 604401     | 71.39 G | 605184 | 93.19 G | -          | -       | -                 | -       |                |
| JH1100 ZXi                        | 96-01 | 604402*    | 70.89 G | 605184 | 93.19 G | -          | -       | -                 | -       | *Race Specific |
| JT1100 STX                        | 97-98 | 604403*    | 70.09 G | 605184 | 93.19 G | -          | -       | -                 | -       | *Race Specific |

accessories  
towables  
body  
controls  
electrical  
driveline  
engine  
fuel & intake  
chemicals  
tie downs  
tools  
towing & loading

**MARINE**

## K&N AIR AND OIL FILTERS

| MODEL                     | YEAR  | AIR FILTER |         | CUSTOM   |         | OIL FILTER |         | CHROME OIL FILTER |         | COMMENTS  |
|---------------------------|-------|------------|---------|----------|---------|------------|---------|-------------------|---------|---|
| <b>KAWASAKI CONTINUED</b> |       |            |         |          |         |            |         |                   |         |   |
| JT1100 STX                | 97-99 | 604401     | 71.39 G | 605184   | 93.19 G | -          |         | -                 |         |   |
| JT1100 STX                | 99    | 604402*    | 70.89 G | 605184   | 93.19 G | -          |         | -                 |         | *SS, Race Specific  |
| JT1100 STX                | 99    | 604403*    | 70.09 G | 605184   | 93.19 G | -          |         | -                 |         | *Black, Race Specific                                     |
| JT1100 STX                | 99    | 604406*    | 65.49 G | 605184   | 93.19 G | -          |         | -                 |         | *Red, Race Specific                                       |
| JT1200 STX-12F            | 03-06 | -          |         | -        |         | KN204      | 15.49 G | KN204C            | 18.79 G |   |
| JT1200 STX-12F            | 07    | -          |         | -        |         | KN303      | 15.49 G | KN303C            | 19.89 G |   |
| JT1500 STX-15F            | 04-09 | -          |         | -        |         | KN204      | 15.49 G | KN204C            | 18.79 G |   |
| JT1500 STX-15F            | 07-09 | -          |         | -        |         | KN303      | 15.49 G | KN303C            | 19.89 G |   |
| JT1500 STX                | 10    | -          |         | -        |         | KN204      | 15.49 G | KN204C            | 18.79 G |   |
| JT1500 STX-15F            | 10-11 | -          |         | -        |         | KN204      | 15.49 G | KN204C            | 18.79 G |   |
| JT1500 STX-15F            | 12    | -          |         | -        |         | KN116      | 8.29 G  | -                 |         |   |
| JT1500 STX-15F            | 13-14 | -          |         | -        |         | KN204      | 15.49 G | KN204C            | 18.79 G |   |
| JT1500 STX-15F            | 15    | -          |         | -        |         | KN303      | 15.49 G | KN303C            | 19.89 G |   |
| JT1500 STX-15F            | 16    | -          |         | -        |         | KN204      | 15.49 G | KN204C            | 18.79 G |   |
| JT1500 Ultra 260 LX       | 10    | -          |         | -        |         | KN204      | 15.49 G | KN204C            | 18.79 G |   |
| JT1500 Ultra 260 X        | 10    | -          |         | -        |         | KN204      | 15.49 G | KN204C            | 18.79 G |   |
| JT1500 Ultra 300 LX       | 13    | -          |         | -        |         | KN204      | 15.49 G | KN204C            | 18.79 G |   |
| JT1500 Ultra 300 X        | 13    | -          |         | -        |         | KN204      | 15.49 G | KN204C            | 18.79 G |   |
| JT1500 Ultra 310LX        | 14-16 | -          |         | -        |         | KN204      | 15.49 G | KN204C            | 18.79 G |   |
| JT1500 Ultra 310R         | 14-16 | -          |         | -        |         | KN204      | 15.49 G | KN204C            | 18.79 G |   |
| JT1500 Ultra 310X         | 14-16 | -          |         | -        |         | KN204      | 15.49 G | KN204C            | 18.79 G |   |
| JT1500 Ultra 310X SE      | 14-16 | -          |         | -        |         | KN204      | 15.49 G | KN204C            | 18.79 G |   |
| JT1500 Ultra LX           | 10-11 | -          |         | -        |         | KN204      | 15.49 G | KN204C            | 18.79 G |   |
| JT1500 Ultra LX           | 12    | -          |         | -        |         | KN116      | 8.29 G  | -                 |         |   |
| JT1500 Ultra LX           | 13-15 | -          |         | -        |         | KN204      | 15.49 G | KN204C            | 18.79 G |   |
| Ultra 300 LX              | 11-12 | -          |         | -        |         | KN204      | 15.49 G | KN204C            | 18.79 G |   |
| Ultra 300 X               | 11-12 | -          |         | -        |         | KN204      | 15.49 G | KN204C            | 18.79 G |   |
| JT1500 STX                | 09    | -          |         | -        |         | KN204      | 15.49 G | KN204C            | 18.79 G |   |
| JT1500 STX                | 09    | -          |         | -        |         | KN303      | 15.49 G | KN303C            | 19.89 G |   |
| JT1500 Ultra 250X         | 07-08 | -          |         | -        |         | KN204      | 15.49 G | KN204C            | 18.79 G |   |
| JT1500 Ultra 260 LX       | 09    | -          |         | -        |         | KN204      | 15.49 G | KN204C            | 18.79 G |   |
| JT1500 Ultra 260 X        | 09    | -          |         | -        |         | KN204      | 15.49 G | KN204C            | 18.79 G |   |
| JT1500 Ultra LX           | 07-09 | -          |         | -        |         | KN204      | 15.49 G | KN204C            | 18.79 G |   |
| JT1500 Ultra LX           | 07-09 | -          |         | -        |         | KN303      | 15.49 G | KN303C            | 19.89 G |   |
| <b>POLARIS</b>            |       |            |         |          |         |            |         |                   |         |   |
| SL 650                    | 92-95 | 604400     | 88.29 G | 605189*  | 85.29 G | -          |         | -                 |         | *Use w/604403   |
| SL 650                    | 92-95 | 604403*    | 70.09 G | 605189** | 85.29 G | -          |         | -                 |         | *Race Specific, Req three 605189 adapters/ **Use w/604403 |
| SLH                       | 01    | 604407*    | 72.79 G | -        |         | -          |         | -                 |         | *Race Specific  |
| Virage 701                | 00-01 | 604407*    | 72.79 G | -        |         | -          |         | -                 |         | *Race Specific  |
| SL 750                    | 93-95 | 604400     | 88.29 G | 605189*  | 85.29 G | -          |         | -                 |         | *Use w/604403   |
| SL 750                    | 93-95 | 604403*    | 70.09 G | 605189** | 85.29 G | -          |         | -                 |         | *Race Specific, Req three 605189 adapters/ **Use w/604403 |
| SLT 750                   | 94-95 | 604400     | 88.29 G | 605189*  | 85.29 G | -          |         | -                 |         | *Use w/604403   |
| SLT 750                   | 94-95 | 604403*    | 70.09 G | 605189** | 85.29 G | -          |         | -                 |         | *Race Specific, Req three 605189 adapters/ **Use w/604403 |
| SLT 780                   | 96    | 604401     | 71.39 G | 605189   | 85.29 G | -          |         | -                 |         |   |
| SLT 780                   | 96    | 604403*    | 70.09 G | 605189   | 85.29 G | -          |         | -                 |         | *Race Specific  |
| SLX 780                   | 96    | 604401     | 71.39 G | 605189   | 85.29 G | -          |         | -                 |         |   |
| SLX 780                   | 96    | 604403*    | 70.09 G | 605189   | 85.29 G | -          |         | -                 |         | *Race Specific  |
| SL 1050                   | 97    | 604408*    | 72.79 G | 605187   | 93.19 G | -          |         | -                 |         | *Race Specific  |
| SLXH                      | 98    | 604408*    | 72.79 G | -        |         | -          |         | -                 |         | *Race Specific  |
| <b>SEA DOO</b>            |       |            |         |          |         |            |         |                   |         |   |
| SP                        | 95-97 | 604397     | 86.79 G | 605190   | 97.49 G | -          |         | -                 |         |   |
| SP                        | 95-97 | 604407*    | 72.79 G | 605190   | 97.49 G | -          |         | -                 |         | *Race Specific  |
| GT                        | 90-91 | 604397     | 86.79 G | 605190   | 97.49 G | -          |         | -                 |         |   |
| GT                        | 90-91 | 604407*    | 72.79 G | 605190   | 97.49 G | -          |         | -                 |         | *Race Specific  |
| GTX                       | 92-94 | 604402*    | 70.89 G | 605189** | 85.29 G | -          |         | -                 |         | *Race Specific/ **Req both adapters                       |
| GTX                       | 92-94 | 604402*    | 70.89 G | 605190** | 97.49 G | -          |         | -                 |         | *Race Specific/ **Req both adapters                       |
| GTX                       | 92-94 | 604420     | 92.49 G | 605189*  | 85.29 G | -          |         | -                 |         | *Req both adapters  |

accessories

towables

body

controls

electrical

driveline

engine

**fuel & intake**

chemicals

tie downs

tools

towing & loading

**MARINE**

# FUEL & INTAKE

## K&N AIR AND OIL FILTERS

| MODEL                    | YEAR  | AIR FILTER |       | CUSTOM |          | OIL FILTER | CHROME OIL FILTER | COMMENTS |   |   |
|--------------------------|-------|------------|-------|--------|----------|------------|-------------------|----------|---|---|
| <b>SEA DOO CONTINUED</b> |       |            |       |        |          |            |                   |          |   |   |
| GTX                      | 92-94 | 604420     | 92.49 | G      | 605190*  | 97.49      | G                 | -        | - | *Req both adapt-ers                     |
| SP                       | 88-94 | 604397     | 86.79 | G      | 605190   | 97.49      | G                 | -        | - |   |
| SP                       | 88-94 | 604407*    | 72.79 | G      | 605190   | 97.49      | G                 | -        | - | *Race Specific                          |
| SPI                      | 88-97 | 604397     | 86.79 | G      | 605190   | 97.49      | G                 | -        | - |   |
| SPI                      | 88-97 | 604407*    | 72.79 | G      | 605190   | 97.49      | G                 | -        | - | *Race Specific                          |
| SPX                      | 92    | 604407*    | 72.79 | G      | 605189   | 85.29      | G                 | -        | - | *Race Specific                          |
| SPX                      | 92    | 604420     | 92.49 | G      | 605189   | 85.29      | G                 | -        | - |   |
| GTX                      | 92-94 | 604402*    | 70.89 | G      | 605189** | 85.29      | G                 | -        | - | *Race Specific/<br>**Req both adapt-ers |
| GTX                      | 92-94 | 604402*    | 70.89 | G      | 605190** | 97.49      | G                 | -        | - | *Race Specific/<br>**Req both adapt-ers |
| GTX                      | 92-94 | 604420     | 92.49 | G      | 605189*  | 85.29      | G                 | -        | - | *Req both adapt-ers                     |
| GTX                      | 92-94 | 604420     | 92.49 | G      | 605190*  | 97.49      | G                 | -        | - | *Req both adapt-ers                     |
| GTX                      | 95    | 604402*    | 70.89 | G      | 605188** | 80.39      | G                 | -        | - | *Race Specific/<br>**Req bracket 605182 |
| GTX                      | 95    | 604417     | 97.49 | G      | 605188*  | 80.39      | G                 | -        | - | *Req bracket 605182                     |
| GS                       | 97-98 | 604402*    | 70.89 | G      | 605188** | 80.39      | G                 | -        | - | *Race Specific/<br>**Req bracket 605183 |
| GS                       | 97-98 | 604417     | 97.49 | G      | 605188*  | 80.39      | G                 | -        | - | *Req bracket 605183                     |
| GTI                      | 96    | 604402*    | 70.89 | G      | 605188** | 80.39      | G                 | -        | - | *Race Specific/<br>**Req bracket 605182 |
| GTI                      | 96    | 604417     | 97.49 | G      | 605188*  | 80.39      | G                 | -        | - | *Req bracket 605182                     |
| GTI                      | 97-98 | 604401     | 71.39 | G      | 605188   | 80.39      | G                 | -        | - |   |
| GTI                      | 97-98 | 604402*    | 70.89 | G      | 605188   | 80.39      | G                 | -        | - | *Race Specific                          |
| GTI                      | 00-01 | 604401     | 71.39 | G      | 605188   | 80.39      | G                 | -        | - |   |
| GTI                      | 00-01 | 604402*    | 70.89 | G      | 605188   | 80.39      | G                 | -        | - | *Race Specific                          |
| GTS                      | 92-96 | 604397     | 86.79 | G      | 605190   | 97.49      | G                 | -        | - |   |
| GTS                      | 92-96 | 604407*    | 72.79 | G      | 605190   | 97.49      | G                 | -        | - | *Race Specific                          |
| GTS                      | 97    | 604397     | 86.79 | G      | 605188   | 80.39      | G                 | -        | - |   |
| GTS                      | 97    | 604402*    | 70.89 | G      | 605188   | 80.39      | G                 | -        | - | *Race Specific                          |
| HX                       | 95-97 | 604401     | 71.39 | G      | -        | -          | -                 | -        | - |   |
| HX                       | 95-97 | 604402*    | 70.89 | G      | -        | -          | -                 | -        | - | *Race Specific                          |
| GSX                      | 96-97 | 604402*    | 70.89 | G      | 605188** | 80.39      | G                 | -        | - | *Race Specific/<br>**Req bracket 605183 |
| GSX                      | 96-97 | 604417     | 97.49 | G      | 605188*  | 80.39      | G                 | -        | - | *Req bracket 605183                     |
| GTX                      | 96-97 | 604402*    | 70.89 | G      | 605188** | 80.39      | G                 | -        | - | *Race Specific/<br>**Req bracket 605183 |
| GTX                      | 96-97 | 604417     | 97.49 | G      | 605188*  | 80.39      | G                 | -        | - | *Req bracket 605183                     |
| SPX                      | 93-94 | 604407*    | 72.79 | G      | 605189   | 85.29      | G                 | -        | - | *Race Specific                          |
| SPX                      | 93-94 | 604420     | 92.49 | G      | 605189   | 85.29      | G                 | -        | - |   |
| SPX                      | 95    | 604407*    | 72.79 | G      | 605188   | 80.39      | G                 | -        | - | *Race Specific                          |
| SPX                      | 95    | 604417     | 97.49 | G      | 605188   | 80.39      | G                 | -        | - |   |
| SPX                      | 96    | 604407*    | 72.79 | G      | 605188** | 80.39      | G                 | -        | - | *Race Specific/<br>**Req bracket 605182 |
| SPX                      | 96    | 604417     | 97.49 | G      | 605188*  | 80.39      | G                 | -        | - | *Req bracket 605182                     |
| SPX                      | 97-98 | 604407*    | 72.79 | G      | 605188** | 80.39      | G                 | -        | - | *Race Specific/<br>**Req bracket 605183 |
| SPX                      | 97-98 | 604417     | 97.49 | G      | 605188*  | 80.39      | G                 | -        | - | *Req bracket 605183                     |
| XP                       | 91-93 | 604407*    | 72.79 | G      | 605189   | 85.29      | G                 | -        | - | *Race Specific                          |
| XP                       | 91-93 | 604420     | 92.49 | G      | 605189   | 85.29      | G                 | -        | - |   |
| XP                       | 94    | 604407*    | 72.79 | G      | 605189** | 85.29      | G                 | -        | - | *Race Specific/<br>**Req bracket 605182 |
| XP                       | 94    | 604417     | 97.49 | G      | 605189*  | 85.29      | G                 | -        | - | *Req bracket 605182                     |
| XP                       | 95    | 604407*    | 72.79 | G      | 605188** | 80.39      | G                 | -        | - | *Race Specific/<br>**Req bracket 605182 |

- accessories
- towables
- body
- controls
- electrical
- driveline
- engine
- fuel & intake**
- chemicals
- tie downs
- tools
- towing & loading

MARINE

## K&N AIR AND OIL FILTERS

| MODEL                       | YEAR  | AIR FILTER |       | CUSTOM |          | OIL FITER |       | CHROME OIL FILTER | COMMENTS |   |
|-----------------------------|-------|------------|-------|--------|----------|-----------|-------|-------------------|----------|---|
| <b>SEA DOO CONTINUED</b>    |       |            |       |        |          |           |       |                   |          |   |
| XP                          | 95    | 604417     | 97.49 | G      | 605188*  | 80.39     | G     | -                 | -        | *Req bracket 605182                     |
| XP                          | 96-97 | 604407*    | 72.79 | G      | 605188** | 80.39     | G     | -                 | -        | *Race Specific/<br>**Req bracket 605183 |
| XP                          | 96-97 | 604417     | 97.49 | G      | 605188*  | 80.39     | G     | -                 | -        | *Req bracket 605183                     |
| GSX Limited                 | 98    | 604407*    | 72.79 | G      | -        | -         | -     | -                 | -        | *Race Specific                          |
| GTX                         | 98    | 604407*    | 72.79 | G      | -        | -         | -     | -                 | -        | *Race Specific                          |
| XP Limited                  | 98    | 604407*    | 72.79 | G      | -        | -         | -     | -                 | -        | *Race Specific                          |
| GTX 4-Tec                   | 02-03 | -          | -     | -      | -        | KN556     | 14.89 | G                 | -        |   |
| GTX 4-Tec Supercharged      | 03-04 | -          | -     | -      | -        | KN556     | 14.89 | G                 | -        |   |
| GTX 4-Tec Wake              | 03    | -          | -     | -      | -        | KN556     | 14.89 | G                 | -        |   |
| GTX 4-Tec Wakeboard Edition | 04    | -          | -     | -      | -        | KN556     | 14.89 | G                 | -        |   |
| 150 Speedster 155HP         | 09    | -          | -     | -      | -        | KN556     | 14.89 | G                 | -        |   |
| 150 Speedster 215HP         | 09    | -          | -     | -      | -        | KN556     | 14.89 | G                 | -        |   |
| 150 Speedster 255HP         | 09    | -          | -     | -      | -        | KN556     | 14.89 | G                 | -        |   |
| 180 Challenger 215HP        | 09    | -          | -     | -      | -        | KN556     | 14.89 | G                 | -        |   |
| 180 Challenger SE 215HP     | 09    | -          | -     | -      | -        | KN556     | 14.89 | G                 | -        |   |
| 180 Challenger SE 255HP     | 09    | -          | -     | -      | -        | KN556     | 14.89 | G                 | -        |   |
| 200 Speedster               | 07-08 | -          | -     | -      | -        | KN556     | 14.89 | G                 | -        |   |
| 200 Speedster 430HP         | 09    | -          | -     | -      | -        | KN556     | 14.89 | G                 | -        |   |
| 205 Utopia SE 310HP         | 09    | -          | -     | -      | -        | KN556     | 14.89 | G                 | -        |   |
| 205 Utopia SE 430HP         | 09    | -          | -     | -      | -        | KN556     | 14.89 | G                 | -        |   |
| 230 Challenger              | 07-08 | -          | -     | -      | -        | KN556     | 14.89 | G                 | -        |   |
| 230 Challenger SE           | 07-08 | -          | -     | -      | -        | KN556     | 14.89 | G                 | -        |   |
| 230 Wake                    | 07-08 | -          | -     | -      | -        | KN556     | 14.89 | G                 | -        |   |
| 230 Wake Eng 2              | 07-08 | -          | -     | -      | -        | KN556     | 14.89 | G                 | -        |   |
| GTI 130                     | 08-14 | -          | -     | -      | -        | KN556     | 14.89 | G                 | -        |   |
| GTI Limited 155             | 11-14 | -          | -     | -      | -        | KN556     | 14.89 | G                 | -        |   |
| GTI SE                      | 06-07 | -          | -     | -      | -        | KN556     | 14.89 | G                 | -        |   |
| GTI SE 130                  | 08-14 | -          | -     | -      | -        | KN556     | 14.89 | G                 | -        |   |
| GTI SE 155                  | 08-14 | -          | -     | -      | -        | KN556     | 14.89 | G                 | -        |   |
| GTI STD                     | 06-07 | -          | -     | -      | -        | KN556     | 14.89 | G                 | -        |   |
| GTX                         | 05-06 | -          | -     | -      | -        | KN556     | 14.89 | G                 | -        |   |
| GTX 155                     | 08-13 | -          | -     | -      | -        | KN556     | 14.89 | G                 | -        |   |
| GTX 215                     | 08-09 | -          | -     | -      | -        | KN556     | 14.89 | G                 | -        |   |
| GTX 215                     | 11-13 | -          | -     | -      | -        | KN556     | 14.89 | G                 | -        |   |
| GTX 4-Tec                   | 04    | -          | -     | -      | -        | KN556     | 14.89 | G                 | -        |   |
| GTX 4-Tec Ltd. Supercharged | 03-04 | -          | -     | -      | -        | KN556     | 14.89 | G                 | -        |   |
| GTX 4-TEC STD               | 05-06 | -          | -     | -      | -        | KN556     | 14.89 | G                 | -        |   |
| GTX 4-Tec Wake              | 05-06 | -          | -     | -      | -        | KN556     | 14.89 | G                 | -        |   |
| GTX Limited                 | 05-06 | -          | -     | -      | -        | KN556     | 14.89 | G                 | -        |   |
| GTX Limited                 | 08    | -          | -     | -      | -        | KN556     | 14.89 | G                 | -        |   |
| GTX Limited iS 255          | 09    | -          | -     | -      | -        | KN556     | 14.89 | G                 | -        |   |
| GTX LTD BVIC                | 07    | -          | -     | -      | -        | KN556     | 14.89 | G                 | -        |   |
| GTX S 155                   | 12-13 | -          | -     | -      | -        | KN556     | 14.89 | G                 | -        |   |
| GTX SC                      | 05-06 | -          | -     | -      | -        | KN556     | 14.89 | G                 | -        |   |
| GTX STD                     | 07    | -          | -     | -      | -        | KN556     | 14.89 | G                 | -        |   |
| GTX Wake                    | 07    | -          | -     | -      | -        | KN556     | 14.89 | G                 | -        |   |
| GTX Wake BVIC               | 07    | -          | -     | -      | -        | KN556     | 14.89 | G                 | -        |   |
| Islandia SE                 | 07-08 | -          | -     | -      | -        | KN556     | 14.89 | G                 | -        |   |
| Islandia Se Eng. 2          | 07-07 | -          | -     | -      | -        | KN556     | 14.89 | G                 | -        |   |
| RXP                         | 05-06 | -          | -     | -      | -        | KN556     | 14.89 | G                 | -        |   |
| RXP 155                     | 08    | -          | -     | -      | -        | KN556     | 14.89 | G                 | -        |   |
| RXP 215                     | 08-10 | -          | -     | -      | -        | KN556     | 14.89 | G                 | -        |   |
| RXP NA                      | 07    | -          | -     | -      | -        | KN556     | 14.89 | G                 | -        |   |
| RXP Supercharged            | 04    | -          | -     | -      | -        | KN556     | 14.89 | G                 | -        |   |
| RXP X 255                   | 08-11 | -          | -     | -      | -        | KN556     | 14.89 | G                 | -        |   |
| RXP X 260                   | 12-13 | -          | -     | -      | -        | KN556     | 14.89 | G                 | -        |   |
| RXT                         | 05-06 | -          | -     | -      | -        | KN556     | 14.89 | G                 | -        |   |
| RXT 215                     | 08-10 | -          | -     | -      | -        | KN556     | 14.89 | G                 | -        |   |
| RXT 260                     | 11-13 | -          | -     | -      | -        | KN556     | 14.89 | G                 | -        |   |
| RXT BVIC                    | 07    | -          | -     | -      | -        | KN556     | 14.89 | G                 | -        |   |
| RXT iS 255                  | 09-12 | -          | -     | -      | -        | KN556     | 14.89 | G                 | -        |   |
| RXT iS 260                  | 10-12 | -          | -     | -      | -        | KN556     | 14.89 | G                 | -        |   |
| RXT X 255                   | 08-09 | -          | -     | -      | -        | KN556     | 14.89 | G                 | -        |   |
| RXT X 260                   | 10-13 | -          | -     | -      | -        | KN556     | 14.89 | G                 | -        |   |
| RXT X aS 260                | 11-13 | -          | -     | -      | -        | KN556     | 14.89 | G                 | -        |   |
| Speedster Wake              | 06-08 | -          | -     | -      | -        | KN556     | 14.89 | G                 | -        |   |
| Speedster Wake 430HP        | 09    | -          | -     | -      | -        | KN556     | 14.89 | G                 | -        |   |
| Speedster Wake Eng. 2       | 06-08 | -          | -     | -      | -        | KN556     | 14.89 | G                 | -        |   |

- accessories
- towables
- body
- controls
- electrical
- driveline
- engine
- fuel & intake**
- chemicals
- tie downs
- tools
- towing & loading

# MARINE

# FUEL & INTAKE

## K&N AIR AND OIL FILTERS

| MODEL                     | YEAR  | AIR FILTER     |              | CUSTOM |               | OIL FILTER    |       | CHROME OIL FILTER |        | COMMENTS       |
|---------------------------|-------|----------------|--------------|--------|---------------|---------------|-------|-------------------|--------|----------------|
| <b>SEA DOO CONTINUED</b>  |       |                |              |        |               |               |       |                   |        |                |
| Sportster SCIC 155HP      | 05    | -              | -            | -      | -             | KN556         | 14.89 | G                 | -      |                |
| Sportster SCIC 215HP      | 05    | -              | -            | -      | -             | KN556         | 14.89 | G                 | -      |                |
| Wake                      | 05-06 | -              | -            | -      | -             | KN556         | 14.89 | G                 | -      |                |
| Wake 155                  | 07-13 | -              | -            | -      | -             | KN556         | 14.89 | G                 | -      |                |
| Wake 215                  | 08    | -              | -            | -      | -             | KN556         | 14.89 | G                 | -      |                |
| Wake Pro 215              | 09-13 | -              | -            | -      | -             | KN556         | 14.89 | G                 | -      |                |
| 200 Speedster             | 05    | -              | -            | -      | -             | KN556         | 14.89 | G                 | -      |                |
| GTI 130                   | 15    | -              | -            | -      | -             | KN556         | 14.89 | G                 | -      |                |
| GTI Limited 155           | 15-16 | -              | -            | -      | -             | KN556         | 14.89 | G                 | -      |                |
| GTI SE 130                | 15-16 | -              | -            | -      | -             | KN556         | 14.89 | G                 | -      |                |
| GTI SE 155                | 15-16 | -              | -            | -      | -             | KN556         | 14.89 | G                 | -      |                |
| GTR 215                   | 14-16 | -              | -            | -      | -             | KN556         | 14.89 | G                 | -      |                |
| GTS 130                   | 14-16 | -              | -            | -      | -             | KN556         | 14.89 | G                 | -      |                |
| GTX 155                   | 14-16 | -              | -            | -      | -             | KN556         | 14.89 | G                 | -      |                |
| GTX Limited 215           | 14-16 | -              | -            | -      | -             | KN556         | 14.89 | G                 | -      |                |
| GTX Limited iS 260        | 14-16 | -              | -            | -      | -             | KN556         | 14.89 | G                 | -      |                |
| GTX S 155                 | 14-16 | -              | -            | -      | -             | KN556         | 14.89 | G                 | -      |                |
| RXP X 260                 | 14-15 | -              | -            | -      | -             | KN556         | 14.89 | G                 | -      |                |
| RXT 260                   | 14-16 | -              | -            | -      | -             | KN556         | 14.89 | G                 | -      |                |
| RXT X 260                 | 14-15 | -              | -            | -      | -             | KN556         | 14.89 | G                 | -      |                |
| RXT X aS 260              | 14-16 | -              | -            | -      | -             | KN556         | 14.89 | G                 | -      |                |
| Wake 155                  | 14-16 | -              | -            | -      | -             | KN556         | 14.89 | G                 | -      |                |
| Wake Pro 215              | 14-16 | -              | -            | -      | -             | KN556         | 14.89 | G                 | -      |                |
| <b>YAMAHA</b>             |       |                |              |        |               |               |       |                   |        |                |
| WJ500 Wave Jammer         | 88-90 | <b>604396</b>  | <b>88.39</b> | G      | <b>605189</b> | <b>85.29</b>  | G     | -                 | -      |                |
| WJ500 Wave Jammer         | 88-90 | <b>604408*</b> | <b>72.79</b> | G      | <b>605189</b> | <b>85.29</b>  | G     | -                 | -      | *Race Specific |
| WR500                     | 92    | <b>604396</b>  | <b>88.39</b> | G      | <b>605189</b> | <b>85.29</b>  | G     | -                 | -      |                |
| WR500                     | 92    | <b>604408*</b> | <b>72.79</b> | G      | <b>605189</b> | <b>85.29</b>  | G     | -                 | -      | *Race Specific |
| WR500 WaveRunner          | 88-92 | <b>604396</b>  | <b>88.39</b> | G      | <b>605189</b> | <b>85.29</b>  | G     | -                 | -      |                |
| WR500 WaveRunner          | 88-93 | <b>604408*</b> | <b>72.79</b> | G      | <b>605189</b> | <b>85.29</b>  | G     | -                 | -      | *Race Specific |
| WRA650 WaveRunner III     | 90-96 | <b>604399</b>  | <b>86.49</b> | G      | <b>605197</b> | <b>131.89</b> | G     | -                 | -      |                |
| WRB650 WaveRunner VXR     | 91-95 | <b>604399</b>  | <b>86.49</b> | G      | <b>605197</b> | <b>131.89</b> | G     | -                 | -      |                |
| SJ650 Super Jet           | 90-93 | <b>604396</b>  | <b>88.39</b> | G      | <b>605193</b> | <b>88.49</b>  | G     | -                 | -      |                |
| SJ650 Super Jet           | 90-93 | <b>604408*</b> | <b>72.79</b> | G      | <b>605193</b> | <b>88.49</b>  | G     | -                 | -      | *Race Specific |
| WR650 WaveRunner          | 90-92 | <b>604396</b>  | <b>88.39</b> | G      | <b>605193</b> | <b>88.49</b>  | G     | -                 | -      |                |
| WR650 WaveRunner          | 90-92 | <b>604408*</b> | <b>72.79</b> | G      | <b>605193</b> | <b>88.49</b>  | G     | -                 | -      | *Race Specific |
| RA700 Wave Raider         | 94-95 | <b>604401</b>  | <b>71.39</b> | G      | <b>605191</b> | <b>82.19</b>  | G     | -                 | -      |                |
| RA700 Wave Raider         | 96-97 | <b>604401</b>  | <b>71.39</b> | G      | <b>605199</b> | <b>91.29</b>  | G     | -                 | -      |                |
| RA700 Wave Raider         | 96-97 | <b>604403*</b> | <b>70.09</b> | G      | <b>605199</b> | <b>91.29</b>  | G     | -                 | -      | *Race Specific |
| FX700 FX-1                | 94-95 | <b>604396</b>  | <b>88.39</b> | G      | <b>605193</b> | <b>88.49</b>  | G     | -                 | -      |                |
| SJ700 Super Jet           | 94-95 | <b>604396</b>  | <b>88.39</b> | G      | <b>605193</b> | <b>88.49</b>  | G     | -                 | -      |                |
| SJ700 Super Jet           | 94-95 | <b>604407*</b> | <b>72.79</b> | G      | <b>605193</b> | <b>88.49</b>  | G     | -                 | -      | *Race Specific |
| SJ700 Super Jet           | 96-98 | <b>604401</b>  | <b>71.39</b> | G      | <b>605189</b> | <b>85.29</b>  | G     | -                 | -      |                |
| SJ700 Super Jet           | 96-98 | <b>604402*</b> | <b>70.89</b> | G      | <b>605189</b> | <b>85.29</b>  | G     | -                 | -      | *Race Specific |
| WB700 Wave Blaster        | 93-95 | <b>604399</b>  | <b>86.49</b> | G      | <b>605197</b> | <b>131.89</b> | G     | -                 | -      |                |
| WRA700 WaveRunner         | 95-97 | <b>604399</b>  | <b>86.49</b> | G      | <b>605197</b> | <b>131.89</b> | G     | -                 | -      |                |
| WRB700 WaveRunner Pro VXR | 93-94 | <b>604399</b>  | <b>86.49</b> | G      | <b>605197</b> | <b>131.89</b> | G     | -                 | -      |                |
| WVT700 Wave Venture       | 95    | <b>604401</b>  | <b>71.39</b> | G      | <b>605191</b> | <b>82.19</b>  | G     | -                 | -      |                |
| WVT700 Wave Venture       | 95    | <b>604402*</b> | <b>70.89</b> | G      | <b>605191</b> | <b>82.19</b>  | G     | -                 | -      | *Race Specific |
| GP760 WaveRunner          | 98-99 | <b>604401</b>  | <b>71.39</b> | G      | <b>605194</b> | <b>87.39</b>  | G     | -                 | -      |                |
| GP760 WaveRunner          | 98-99 | <b>604402*</b> | <b>70.89</b> | G      | <b>605194</b> | <b>87.39</b>  | G     | -                 | -      | *Race Specific |
| RA760 Wave Raider         | 96    | <b>604401</b>  | <b>71.39</b> | G      | <b>605193</b> | <b>88.49</b>  | G     | -                 | -      |                |
| RA760 Wave Raider         | 96    | <b>604402*</b> | <b>70.89</b> | G      | <b>605193</b> | <b>88.49</b>  | G     | -                 | -      | *Race Specific |
| WB760 Wave Blaster        | 96-97 | <b>604401</b>  | <b>71.39</b> | G      | <b>605193</b> | <b>88.49</b>  | G     | -                 | -      |                |
| WB760 Wave Blaster        | 96-97 | <b>604402*</b> | <b>70.89</b> | G      | <b>605193</b> | <b>88.49</b>  | G     | -                 | -      | *Race Specific |
| XL760 WaveRunner          | 98-99 | <b>604402*</b> | <b>70.89</b> | G      | <b>605199</b> | <b>91.29</b>  | G     | -                 | -      | *Race Specific |
| XL760 WaveRunner          | 98-99 | <b>604419</b>  | <b>98.79</b> | G      | <b>605199</b> | <b>91.29</b>  | G     | -                 | -      |                |
| GP760 WaveRunner          | 97    | <b>604401</b>  | <b>71.39</b> | G      | <b>605194</b> | <b>87.39</b>  | G     | -                 | -      |                |
| GP760 WaveRunner          | 97    | <b>604402*</b> | <b>70.89</b> | G      | <b>605194</b> | <b>87.39</b>  | G     | -                 | -      | *Race Specific |
| FAT1100 212SS             | 08-09 | -              | -            | -      | -             | KN204         | 15.49 | G                 | KN204C | 18.79 G        |
| FAT1100 212SS Eng 2       | 08-09 | -              | -            | -      | -             | KN204         | 15.49 | G                 | KN204C | 18.79 G        |
| FAT1100 212X Eng 1        | 08-09 | -              | -            | -      | -             | KN204         | 15.49 | G                 | KN204C | 18.79 G        |
| FAT1100 212X Eng 2        | 08-09 | -              | -            | -      | -             | KN204         | 15.49 | G                 | KN204C | 18.79 G        |
| FRT1100 AR210 Eng 1       | 06-07 | -              | -            | -      | -             | KN303         | 15.49 | G                 | KN303C | 19.89 G        |
| FRT1100 AR210 Eng 1       | 08-09 | -              | -            | -      | -             | KN204         | 15.49 | G                 | KN204C | 18.79 G        |
| FRT1100 AR210 Eng 2       | 06-07 | -              | -            | -      | -             | KN303         | 15.49 | G                 | KN303C | 19.89 G        |
| FRT1100 AR210 Eng 2       | 08-09 | -              | -            | -      | -             | KN204         | 15.49 | G                 | KN204C | 18.79 G        |
| FRT1100 SR210             | 06-07 | -              | -            | -      | -             | KN303         | 15.49 | G                 | KN303C | 19.89 G        |
| FRT1100 SR210 Eng 2       | 06-07 | -              | -            | -      | -             | KN303         | 15.49 | G                 | KN303C | 19.89 G        |
| FRT1100 SX210             | 06-07 | -              | -            | -      | -             | KN303         | 15.49 | G                 | KN303C | 19.89 G        |
| FRT1100 SX210             | 08    | -              | -            | -      | -             | KN204         | 15.49 | G                 | KN204C | 18.79 G        |
| FRT1100 SX210 Eng 2       | 06-07 | -              | -            | -      | -             | KN303         | 15.49 | G                 | KN303C | 19.89 G        |
| FRT1100 SX210 Eng 2       | 08    | -              | -            | -      | -             | KN204         | 15.49 | G                 | KN204C | 18.79 G        |

accessories  
towables  
body  
controls  
electrical  
driveline  
engine  
fuel & intake

chemicals  
tie downs  
tools  
towing & loading

MARINE



## K&N AIR AND OIL FILTERS

| MODEL                             | YEAR  | AIR FILTER |       | CUSTOM |        | OIL FILTER |       |   | CHROME OIL FILTER |       | COMMENTS |                |
|-----------------------------------|-------|------------|-------|--------|--------|------------|-------|---|-------------------|-------|----------|----------------|
| <b>YAMAHA CONTINUED</b>           |       |            |       |        |        |            |       |   |                   |       |          |                |
| FX1000 WaveRunner                 | 05-06 | -          | -     | -      | -      | KN303      | 15.49 | G | KN303C            | 19.89 | G        |                |
| FX1000 WaveRunner Cruiser         | 05-07 | -          | -     | -      | -      | KN303      | 15.49 | G | KN303C            | 19.89 | G        |                |
| FX1000 WaveRunner Cruiser         | 08    | -          | -     | -      | -      | KN204      | 15.49 | G | KN204C            | 18.79 | G        |                |
| FX1000 WaveRunner FX              | 07    | -          | -     | -      | -      | KN303      | 15.49 | G | KN303C            | 19.89 | G        |                |
| FX1000 WaveRunner FX              | 08    | -          | -     | -      | -      | KN204      | 15.49 | G | KN204C            | 18.79 | G        |                |
| FX1100 WaveRunner Cruiser H.O.    | 04-06 | -          | -     | -      | -      | KN303      | 15.49 | G | KN303C            | 19.89 | G        |                |
| FX1100 WaveRunner FX Cruiser H.O. | 07    | -          | -     | -      | -      | KN303      | 15.49 | G | KN303C            | 19.89 | G        |                |
| FX1100 WaveRunner H.O.            | 04-06 | -          | -     | -      | -      | KN303      | 15.49 | G | KN303C            | 19.89 | G        |                |
| FX1100 WaveRunner H.O.            | 08    | -          | -     | -      | -      | KN204      | 15.49 | G | KN204C            | 18.79 | G        |                |
| SRT1000 AR230 Eng 1               | 04-05 | -          | -     | -      | -      | KN303      | 15.49 | G | KN303C            | 19.89 | G        |                |
| SRT1000 AR230 Eng 2               | 04-05 | -          | -     | -      | -      | KN303      | 15.49 | G | KN303C            | 19.89 | G        |                |
| SRT1000 SR230                     | 03-05 | -          | -     | -      | -      | KN303      | 15.49 | G | KN303C            | 19.89 | G        |                |
| SRT1000 SR230 Eng 2               | 03-05 | -          | -     | -      | -      | KN303      | 15.49 | G | KN303C            | 19.89 | G        |                |
| SRT1000 SX230                     | 04-05 | -          | -     | -      | -      | KN303      | 15.49 | G | KN303C            | 19.89 | G        |                |
| SRT1000 SX230 Eng 2               | 04-05 | -          | -     | -      | -      | KN303      | 15.49 | G | KN303C            | 19.89 | G        |                |
| SRT1100 AR230 H.O. Eng 1          | 05-06 | -          | -     | -      | -      | KN303      | 15.49 | G | KN303C            | 19.89 | G        |                |
| SRT1100 AR230 H.O. Eng 2          | 05-06 | -          | -     | -      | -      | KN303      | 15.49 | G | KN303C            | 19.89 | G        |                |
| SRT1100 SX230 H.O.                | 05-06 | -          | -     | -      | -      | KN303      | 15.49 | G | KN303C            | 19.89 | G        |                |
| SRT1100 SX230 H.O. Eng 2          | 05-06 | -          | -     | -      | -      | KN303      | 15.49 | G | KN303C            | 19.89 | G        |                |
| SXT1100 232 Limited Eng 1         | 08-09 | -          | -     | -      | -      | KN204      | 15.49 | G | KN204C            | 18.79 | G        |                |
| SXT1100 232 Limited Eng 2         | 08-09 | -          | -     | -      | -      | KN204      | 15.49 | G | KN204C            | 18.79 | G        |                |
| SXT1100 AR230 H.O. Eng 1          | 07    | -          | -     | -      | -      | KN303      | 15.49 | G | KN303C            | 19.89 | G        |                |
| SXT1100 AR230 H.O. Eng 1          | 08-09 | -          | -     | -      | -      | KN204      | 15.49 | G | KN204C            | 18.79 | G        |                |
| SXT1100 AR230 H.O. Eng 2          | 07    | -          | -     | -      | -      | KN303      | 15.49 | G | KN303C            | 19.89 | G        |                |
| SXT1100 AR230 H.O. Eng 2          | 08-09 | -          | -     | -      | -      | KN204      | 15.49 | G | KN204C            | 18.79 | G        |                |
| SXT1100 SR230 H.O.                | 07    | -          | -     | -      | -      | KN303      | 15.49 | G | KN303C            | 19.89 | G        |                |
| SXT1100 SR230 H.O. Eng 2          | 07    | -          | -     | -      | -      | KN303      | 15.49 | G | KN303C            | 19.89 | G        |                |
| SXT1100 SX230 H.O.                | 07    | -          | -     | -      | -      | KN303      | 15.49 | G | KN303C            | 19.89 | G        |                |
| SXT1100 SX230 H.O.                | 08-09 | -          | -     | -      | -      | KN204      | 15.49 | G | KN204C            | 18.79 | G        |                |
| SXT1100 SX230 H.O. Eng 2          | 07    | -          | -     | -      | -      | KN303      | 15.49 | G | KN303C            | 19.89 | G        |                |
| SXT1100 SX230 H.O. Eng 2          | 08-09 | -          | -     | -      | -      | KN204      | 15.49 | G | KN204C            | 18.79 | G        |                |
| VX1100 WaveRunner Cruiser         | 07    | -          | -     | -      | -      | KN303      | 15.49 | G | KN303C            | 19.89 | G        |                |
| VX1100 WaveRunner Cruiser         | 08    | -          | -     | -      | -      | KN204      | 15.49 | G | KN204C            | 18.79 | G        |                |
| VX1100 WaveRunner Deluxe          | 05-07 | -          | -     | -      | -      | KN303      | 15.49 | G | KN303C            | 19.89 | G        |                |
| VX1100 WaveRunner Deluxe          | 08    | -          | -     | -      | -      | KN204      | 15.49 | G | KN204C            | 18.79 | G        |                |
| VX1100 WaveRunner Sport           | 05-07 | -          | -     | -      | -      | KN303      | 15.49 | G | KN303C            | 19.89 | G        |                |
| VX1100 WaveRunner Sport           | 08    | -          | -     | -      | -      | KN204      | 15.49 | G | KN204C            | 18.79 | G        |                |
| VX1100 WaveRunner VX              | 07    | -          | -     | -      | -      | KN303      | 15.49 | G | KN303C            | 19.89 | G        |                |
| VX1100 WaveRunner VX              | 08    | -          | -     | -      | -      | KN204      | 15.49 | G | KN204C            | 18.79 | G        |                |
| SRT1000 AR230                     | 06    | -          | -     | -      | -      | KN303      | 15.49 | G | KN303C            | 19.89 | G        |                |
| RA1100 Wave Raider                | 95-96 | 604401     | 71.39 | G      | 605191 | 82.19      | G     | - | -                 | -     | -        |                |
| RA1100 Wave Raider                | 95-96 | 604402*    | 70.89 | G      | 605191 | 82.19      | G     | - | -                 | -     | -        | *Race Specific |
| WVT1100 Wave Venture              | 96-97 | 604401     | 71.39 | G      | 605191 | 82.19      | G     | - | -                 | -     | -        |                |
| WVT1100 Wave Venture              | 96-97 | 604402*    | 70.89 | G      | 605191 | 82.19      | G     | - | -                 | -     | -        | *Race Specific |
| VX1100 WaveRunner VX              | 15    | -          | -     | -      | -      | KN204      | 15.49 | G | KN204C            | 18.79 | G        |                |
| SXT1100 232 Limited S             | 09    | -          | -     | -      | -      | KN204      | 15.49 | G | KN204C            | 18.79 | G        |                |
| VX1100 WaveRunner Cruiser         | 09-15 | -          | -     | -      | -      | KN204      | 15.49 | G | KN204C            | 18.79 | G        |                |
| VX1100 WaveRunner Deluxe          | 09-15 | -          | -     | -      | -      | KN204      | 15.49 | G | KN204C            | 18.79 | G        |                |
| VX1100 WaveRunner Sport           | 09-15 | -          | -     | -      | -      | KN204      | 15.49 | G | KN204C            | 18.79 | G        |                |
| VX1100 WaveRunner VX              | 10    | -          | -     | -      | -      | KN204      | 15.49 | G | KN204C            | 18.79 | G        |                |
| GP1200 WaveRunner                 | 97-98 | 604401     | 71.39 | G      | 605193 | 88.49      | G     | - | -                 | -     | -        |                |
| GP1200 WaveRunner                 | 97-98 | 604402*    | 70.89 | G      | 605193 | 88.49      | G     | - | -                 | -     | -        | *Race Specific |
| XL1200 WaveRunner                 | 98    | 604401     | 71.39 | G      | 605193 | 88.49      | G     | - | -                 | -     | -        |                |
| XL1200 WaveRunner                 | 98    | 604402*    | 70.89 | G      | 605193 | 88.49      | G     | - | -                 | -     | -        | *Race Specific |
| GX1800 WaveRunner FZR             | 11    | -          | -     | -      | -      | KN204      | 15.49 | G | KN204C            | 18.79 | G        |                |
| GX1800A WaveRunner FZS            | 11    | -          | -     | -      | -      | KN204      | 15.49 | G | KN204C            | 18.79 | G        |                |

- accessories
- towables
- body
- controls
- electrical
- driveline
- engine
- fuel & intake**
- chemicals
- tie downs
- tools
- towing & loading

# MARINE

# FUEL & INTAKE

## A BETTER FUEL FILTER FOR ALL GAS-POWERED ENGINES

### What is Visu-filter®?

A highly reliable fuel filter system so unique that Visu-filter® signals the need for replacement in motorcycles, lawn tractors, snowmobiles, jet skis, rototillers, air compressors, and more! The strong, high-impact nylon housing is extremely transparent for immediate viewing. Many styles and sizes available. Wide selections of filter media such as polymer-treated paper with automotive specifications, stainless steel screens and polyester screens.



- Protects engine from harmful contaminants
- No leak, high impact nylon construction
- Functions as a reservoir for trapping water
- Cleaner burning engine, less emission and less smoke
- Better throttle response; improvement in engine performance
- Some increase in power and fuel efficiency

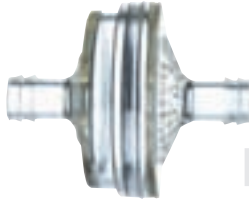

- Stainless Steel Screen
- 75 micron rating
- 1.5" overall diameter
- 1" length between hoses
- Fits 5/16" fuel line

**FF601C** Each **6.95** L



- Stainless Steel Screen
- 75 micron rating
- 1.3" overall diameter
- 1" length between hoses
- Fits 1/4" fuel line

**FF401C** Each **3.95** L



- Paper Element
- 80 micron rating
- 1.63" overall diameter
- 1-3/8" length between hoses
- Fits 1/4" fuel line

**FF861C** Each **3.95** L



- Polyester Screen
- 90 micron rating
- 1.19" overall diameter
- 1-3/8" length between hoses
- Fits 1/4" fuel line

**FF704CB** Each **7.79** L

## SCREW-IN FILTER

- Universal Moto-Ski/Ski Doo
- Screw in base type filter fits all Tillotson and Walbro carburetors HR or HD type



**LP07703** Each **1.95** L

## EXTRA LARGE IN-LINE FILTER

- Jumbo in-line nylon fuel filter
- The nylon screen has a self-cleaning action
- 4" long
- 2 sizes 3/16" or 1/4"
- Sold each (bulk)

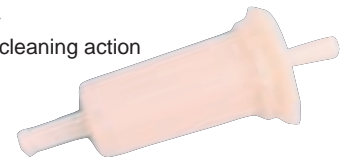

**LP077063** Each (3/16") **2.95** L

**LP077064** Each (1/4") **2.95** L

**EM34441** Master Display (10 each) **20.95** L  
1/4" Only

## SMALL IN-LINE FILTER

- Sturdy nylon "see thru" fuel filter
- 11-12 gallons per hour capacity fuel flow
- Nylon screen traps all dirt particles
- 2" length
- 1/4"



**LP07700** Each **1.95** L

**EM34421** Master Display (15 each) **17.95** L

## IN-LINE FUEL FILTERS

This Fuel Filter is designed to be an outstanding combination of quality filtration and aesthetic appeal • The filter housing is matched from high strength aluminum alloy • This fuel filter features a cleanable bronze filter element



| COLOR  | 1/4"            | 5/16"           |
|--------|-----------------|-----------------|
| CHROME | EM34461 10.95 L | EM34460 10.95 L |
| RED    | EM34470 9.95 L  | EM34430 9.95 L  |
| BLUE   | EM34471 9.95 L  | EM34431 9.95 L  |
| PURPLE | EM34473 9.95 L  | EM34433 9.95 L  |
| GOLD   | EM34474 9.95 L  | EM34434 9.95 L  |

MARINE

## WALBRO TYPE IN-LINE FILTER

- Walbro type in-line design OEM filter used by ARCTIC CAT (0109-579), ROTAX (414-1194-00) and others
- A greatly improved see through filter with a larger fuel flow capacity
- Replaces Walbro 125-512 and others



|                  |      |       |             |   |
|------------------|------|-------|-------------|---|
| <b>62-07019</b>  | Each | 1/4"  | <b>2.95</b> | L |
| <b>62-07020*</b> | Each | 5/16" | <b>2.95</b> | L |

\* Fits newer Arctic Cats

## JUMBO IN-LINE FILTER

- In-line fuel filter designed for use with 1/4" and 7/32" fuel line
- Easily installed by cutting the fuel line and inserting filter

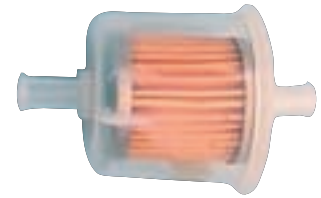

|                 |      |       |             |   |
|-----------------|------|-------|-------------|---|
| <b>LP07707</b>  | Each | 1/4"  | <b>2.95</b> | L |
| <b>62-07014</b> | Each | 7/32" | <b>3.95</b> | L |

## DUAL IN-LINE FILTER

- Super in-line filter
- Inlet/outlet adaptable for both 7/32" and 1/4" ID fuel line



|                 |      |             |   |
|-----------------|------|-------------|---|
| <b>KX072431</b> | Each | <b>3.95</b> | L |
|-----------------|------|-------------|---|

## LARGE IN-LINE FILTER

### Two Step

- Large in-line two-step fuel filter
- 7/32" & 1/4"
- Used on small mowers, tractors & snowmobiles
- Sold each (Bulk)



|             |      |             |   |
|-------------|------|-------------|---|
| <b>1358</b> | Each | <b>3.20</b> | L |
|-------------|------|-------------|---|



## PRIMER BULB ASSEMBLY

**2 SIZES - 1/4" - 3/16"** • Rubber bulb in-line primer complete with bulb in check valves can be installed anywhere along fuel line.

|                 |             |   |                            |
|-----------------|-------------|---|----------------------------|
| <b>LP077002</b> | <b>8.95</b> | L | Use with 1/4" ID fuel line |
| <b>LP077003</b> | <b>8.95</b> | L | Use with 3/16" ID fuel     |

## UNIVERSAL PLUNGER TYPE PRIMER

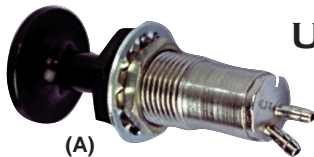

(A)



(B) Sold Separately



(C) Brass Body - Chrome Plated

|                 |                            |              |   |
|-----------------|----------------------------|--------------|---|
| <b>PK2256</b>   | Complete Kit               | <b>23.95</b> | L |
| <b>PK2266</b>   | Complete Kit w/brass inlet | <b>24.95</b> | L |
| <b>DP11305</b>  | (A) Primer Only            | <b>15.70</b> | L |
| <b>LP077161</b> | (B) "T" Only - Plastic     | <b>1.24</b>  | L |
| <b>LP077587</b> | (C) Inlet Connector        | <b>1.85</b>  | L |



## BUTTON TYPE PRIMER

Rubber button type primer kit complete with filtered "T" fitting and primer hose. Dash mounted installation.



(A)

|                 |     |              |   |              |
|-----------------|-----|--------------|---|--------------|
| <b>PK2250</b>   | (A) | <b>14.99</b> | L | Complete Kit |
| <b>DP11589</b>  |     | <b>15.95</b> | L | Primer Only  |
| <b>LP077161</b> |     | <b>1.24</b>  | L | (T only)     |

## PLUNGER TYPE PRIMER

(Exactly like OEM)



PRIMER ONLY - Used to pump fuel into the carburetor

|                |                 |   |
|----------------|-----------------|---|
| <b>DP11305</b> | <b>15.70 ea</b> | L |
|----------------|-----------------|---|

- accessories
- towables
- body
- controls
- electrical
- driveline
- engine
- fuel & intake**
- chemicals
- tie downs
- tools
- towing & loading

# MARINE

# FUEL & INTAKE

## FUEL FLOW SHUT OFF VALVES - SOLD EACH

1/4" In-line cut-off valve. Uses (2) clamps our 20-5905. Composite Material.



5841 4.15 L

New design brass in-line. Uses double neoprene seals and two standard O-rings. All uses with 1/4" line.



678038 10.99 E

1/4" Nipple - 90°

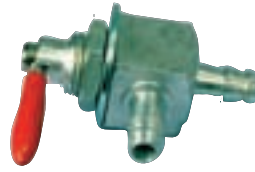

LP077118 11.95 L

1/4" Nipple Straight



868 11.95 L

## FUEL LINE FITTINGS - SOLD EACH

1/8" plastic "T" fitting



LP077161 1.24 L

1/4" plastic "T" fitting

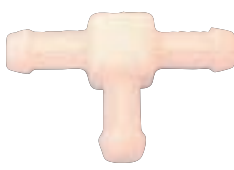

LP077812 1.00 L

1/4" straight metal fitting for impulse line or carburetor.



LP077077 1.25 L

3/32" plastic "T" fitting

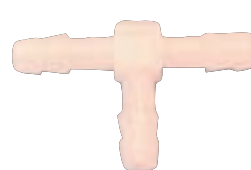

LP077126 1.00 L

1/4" plastic "Y" fitting



LP077227 1.40 L

"L" fuel fitting 1/4" & 7/16" nipple. Used with our DP10672.

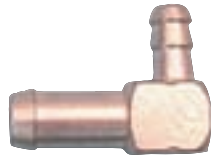

8678 3.60 L

Straight fuel fitting 1/4" & 7/16" nipple. Used with our DP10672. Metal 1 1/2" length.



8679 1.80 L

Brushed elbow metal press fitting with rubber grommet. Can be added to any metal tank by drilling 1/2" hole, insert fitting and tighten.



LP077250 4.95 L

Rubber grommet only for elbow fitting LP077250. Universal.



DP10672 0.95 L

Primer inlet needle to convert Mikuni carburetors to primer or button type dash mounted primers.



LP077587 1.85 L

## QUICK-DISCONNECT COUPLINGS

- Single or dual shut-off valves
- When connected, fuel will flow & when disconnected, fuel will not flow
- Available for 1/4" & 5/16" I.D. fuel line
- Made in the USA

|        |                                  |       |   |
|--------|----------------------------------|-------|---|
| 142587 | No Shut Off 1/4" fuel line       | 17.50 | E |
| 142588 | No Shut Off 5/16" fuel line      | 15.99 | E |
| 672029 | Single-Shut-off, 1/4" fuel line  | 22.99 | E |
| 142617 | Replacement O-Rings for 672029   | 1.16  | G |
| 672030 | Single-Shut-off, 5/16" fuel line | 26.99 | E |
| 142618 | Replacement O-Rings for 672030   | 0.67  | E |
| 672037 | Dual-Shut-off, 1/4" fuel line    | 34.99 | E |
| 672038 | Dual-Shut-off, 5/16" fuel line   | 30.50 | E |



## REPLACEMENT PLASTIC "Y" CONNECTORS

Sold each



|        |               |       |   |
|--------|---------------|-------|---|
| 682014 | 3/16" Plastic | 2.40  | H |
| 682015 | 1/4" Plastic  | 35.99 | H |
| 682017 | 3/8" Plastic  | 4.40  | H |



## REPLACEMENT PLASTIC "T" CONNECTORS

Sold each



|        |              |      |   |
|--------|--------------|------|---|
| 682019 | 1/4" Plastic | 2.70 | G |
| 682021 | 3/8" Plastic | 4.30 | E |

## HELIX TRANSPARENT TUBING AND HOSE

Helix® Fuel line is a premium polyurethane, 85 durometer, which provides for superior abrasions and kink, tear, oxidation and chemical resistance. Melting temp 370f. Operating temp -75f to 155f. Very strong and stays flexible.



| PART #       | RED    | BLUE   | CLEAR  |      |   |
|--------------|--------|--------|--------|------|---|
| 1/8" x 5 FT  | 920000 | 920001 | 920002 | 9.95 | H |
| 3/16" x 3 FT | 920003 | 920004 | 920005 | 5.95 | H |
| 1/4" x 3 FT  | 920006 | 920007 | 920008 | 6.95 | H |
| 5/16" x 3 FT | 920009 | 920010 | 920011 | 6.95 | H |
| 3/8" x 3 FT  | 920012 | 920013 | 920014 | 8.95 | H |

## HELIX OPAQUE TUBING AND HOSE

Helix® Fuel line is a premium polyurethane, 85 durometer, which provides for superior abrasions and kink, tear, oxidation and chemical resistance. Melting temp 370f. Operating temp -75f to 155f. Very strong and stays flexible.



| PART #       | BLACK  |      |   |  |  |
|--------------|--------|------|---|--|--|
| 1/8" x 5 FT  | 920015 | 9.95 | H |  |  |
| 3/16" x 3 FT | 920016 | 5.95 | H |  |  |
| 1/4" x 3 FT  | 920017 | 6.95 | H |  |  |
| 5/16" x 3 FT | 920018 | 6.95 | H |  |  |
| 3/8" x 3 FT  | 920019 | 8.95 | H |  |  |

## HELIX CARB APPROVED FUEL LINE

This CARB approved EPA fuel line meets and exceeds Government Requirement for permeation of fuel vapors. This tubing has a multilayer extrusion that fuel cannot penetrate.



| PART #       | GRAY   |       |   |  |  |
|--------------|--------|-------|---|--|--|
| 3/16" x 3 FT | 920020 | 18.95 | H |  |  |
| 1/4" x 3 FT  | 920021 | 23.95 | H |  |  |
| 5/16" x 3 FT | 920020 | 18.95 | H |  |  |

## FLEX GP70 PVC TUBING

Clear and flexible • Resists aging • Easy to connect • Excellent wearability • Smooth inner wall • 100 foot rolls



| PART # | ID    | WALL  |       |   |  |
|--------|-------|-------|-------|---|--|
| 351800 | 1/8"  | 1/16" | 23.95 | L |  |
| 353600 | 3/16" | 1/16" | 29.95 | L |  |
| 354400 | 1/4"  | 1/16" | 32.95 | L |  |

## BLUE POLYURETHANE FUEL LINE

High quality transparent blue urethane fuel line with exceptional gas and oil resistance. It will withstand temperatures to -65°. It stays soft and pliable.



|          |          |     |       |   |  |
|----------|----------|-----|-------|---|--|
| 62-07010 | 1/8" ID  | 25' | 8.95  | L |  |
| 62-07011 | 3/16" ID | 50' | 34.95 | L |  |
| 62-07012 | 1/4" ID  | 50' | 51.95 | L |  |
| 62-07013 | 7/32" ID | 50' | 40.95 | L |  |

## TYGON FUEL AND LUBRICANT TUBING

- 50 foot rolls
- Flexible
- Resists swelling and brittleness
- Yellow



|      |                     |        |   |  |  |
|------|---------------------|--------|---|--|--|
| 6616 | .080" ID x .140" OD | 54.20  | J |  |  |
| 6617 | 3/32" ID x 3/16" OD | 54.20  | J |  |  |
| 6618 | 1/8" ID x 1/4" OD   | 71.10  | J |  |  |
| 6619 | 3/16" ID x 5/16" OD | 97.95  | N |  |  |
| 6620 | 1/4" ID x 3/8" OD   | 125.85 | J |  |  |

## FUELFLEX™ 65 PVC FUEL TUBING

- 100 foot rolls
- Flexible and easy to install
- Resists swelling and hardening



| PART # | ID   | WALL  |       |   |  |
|--------|------|-------|-------|---|--|
| 354201 | 1/8" | 1/16" | 39.95 | L |  |
| 354202 | 1/4" | 1/16" | 59.95 | L |  |

## BLUE POLYURETHANE FUEL LINE

- 10 foot rolls only
- Stays soft and pliable
- Withstands temperatures to -65°
- Exceptional gas and oil resistance



|        |                 |     |      |   |  |
|--------|-----------------|-----|------|---|--|
| 574410 | 3/16" - 1/4" ID | 10' | 9.95 | L |  |
|--------|-----------------|-----|------|---|--|

## FUELFLEX™ 70 PVC FUEL TUBING

FuelFlex 70 tubing is a flexible, premium-grade product specifically formulated for use with petroleum-based products. Compared to FuelFlex 65 and other fuel resistant PVC products, FuelFlex 70 offers higher resistance to elevated concentrations of Ethanol.

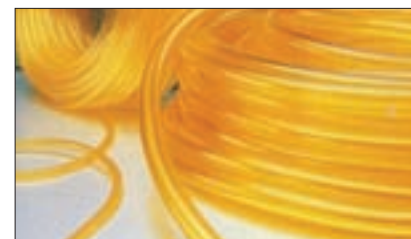

|        |                          |       |   |  |  |
|--------|--------------------------|-------|---|--|--|
| 480001 | Fuel Flex 70 1/8" x 50'  | 28.95 | L |  |  |
| 480002 | Fuel Flex 70 3/16" x 50' | 33.95 | L |  |  |
| 480003 | Fuel Flex 70 1/4" x 50'  | 39.95 | L |  |  |

- accessories
- towables
- body
- controls
- electrical
- driveline
- engine
- fuel & intake
- chemicals
- tie downs
- tools
- towing & loading

# MARINE

# FUEL & INTAKE

- accessories
- towables
- body
- controls
- electrical
- driveline
- engine
- fuel & intake**
- chemicals
- tie downs
- tools
- towing & loading

## CLEAR PVC FUEL LINE

- Constructed of plasticized PVC
- Soft flexible tubing
- Safe to use with any type of gasoline or alcohol type fuel
- Smooth hard bore helps prevent interior build up
- Recommended for venting and overflow lines



| PART #   | 3 FEET |      |   | 25 FEET |       |   |
|----------|--------|------|---|---------|-------|---|
| 1/8" ID  | 142602 | 2.99 | G | 142544  | 10.99 | E |
| 3/16" ID | 142603 | 3.20 | E | 142545  | 13.99 | E |
| 1/4" ID  | 142604 | 4.50 | E | 142545  | 13.99 | E |
| 5/16" ID | 142605 | 4.99 | E | 670003  | 27.99 | E |
| 3/8" ID  | 142606 | 4.99 | E | 142548  | 27.99 | E |

## BRAIDED VINYL FUEL LINE

- Nylon-reinforced vinyl fuel line
- Braided nylon within the tubing wall provides added strength
- Outstanding appearance for custom fuel lines



| PART #   | 3 FEET |      |   | 25 FEET |       |   |
|----------|--------|------|---|---------|-------|---|
| 3/16" ID | 142598 | 6.99 | E | 142549  | 38.99 | E |
| 1/4" ID  | 142599 | 6.99 | E | 142550  | 41.50 | E |
| 5/16" ID | 142600 | 9.99 | E | 142551  | 59.99 | E |
| 3/8" ID  | 142601 | 9.99 | E | 142552  | 64.99 | E |

## LOW PERMEATION FUEL LINE

- Our new low permeation fuel line meets the 2008 C.A.R.B. and EPA fuel line permeation standards for motorcycles, ATV, Snowmobiles, PWC, and small engines
- Flexible and kink resistant
- Gray color



| PART #   | 3 FEET |       |   | 25 FEET |        |   |
|----------|--------|-------|---|---------|--------|---|
| 1/4" ID  | 142609 | 17.99 | E | 142607  | 128.99 | E |
| 5/16" ID | 142610 | 20.99 | E | 142608  | 166.50 | E |

## PREMIUM FUEL LINE

- Our best quality fuel line
- Stronger and more durable than vinyl fuel line
- Use with any type of gasoline
- Resists swelling and hardening
- Resistant to direct sunlight, hardening and/or cracking
- Flexible in temperatures from ̢35F to +165F
- Fuel line stretches easily over fittings or petcocks



|          | 3 FEET BLACK  |          | CLEAR  |          | GRAY   |          |
|----------|---------------|----------|--------|----------|--------|----------|
| 1/8" ID  | ---           |          | 142501 | 7.99     | H      | ---      |
| 3/16" ID | 142590        | 13.99 E  | 142591 | 13.99 E  | 142589 | 13.99 E  |
| 1/4" ID  | 142593        | 17.99 E  | 142594 | 17.99 E  | 142592 | 17.99 E  |
| 5/16" ID | 142596        | 22.99 E  | 142597 | 22.99 E  | 142595 | 22.99 E  |
|          | 25 FEET BLACK |          | CLEAR  |          | GRAY   |          |
| 1/8" ID  | ---           |          | 143500 | 89.99 E  | ---    |          |
| 3/16" ID | 142580        | 96.99 E  | 142583 | 96.99 E  | 142571 | 96.99 E  |
| 1/4" ID  | 142581        | 128.99 E | 142584 | 128.99 E | 142572 | 128.99 E |
| 5/16" ID | 142582        | 164.99 E | 142585 | 164.99 E | 142573 | 164.99 E |

## CLEAR PVC FUEL LINE

- 25 foot rolls
- Chemical and oil resistant
- Smooth and flexible fuel line for all types of small engines
- Translucent
- 100% PVC



670003 5/16" x 1/2" 25' 27.99 roll E

## BLACK NITRILE FUEL LINE

- Black Braided Fuel Line
- 1/4" ID x 1/2" OD X 25 Ft.
- Nitrile Fuel line reinforced with Rayon
- Reinforced for strength
- Grease & Oil Resistant



1502 1/4" ID 25' 35.50 roll J

## HOSE PROTECTORS



- Stainless steel
- Fits on the outside of hoses and tubing
- Protects hoses from rips, tears and hot engine parts

|        |                       |       |   |
|--------|-----------------------|-------|---|
| 920028 | 1.5" diameter (38MM)  | 10.95 | H |
| 920029 | 1.0" diameter (25MM)  | 9.95  | H |
| 920030 | 7/16" diameter (11MM) | 9.95  | H |
| 920031 | 3/8" diameter (9MM)   | 9.95  | H |

## STEPLESS CLAMP FUEL LINE FITTINGS KIT

- Convenient kit includes 70 pcs of hardware, a Motion Pro Side Jaw Pincer tool, and a convenient fuel line clamp size chart
- Kit includes following items packed in a convenient storage box:

| Contains: |  |        |
|-----------|--|--------|
| 142612    | Stepless Clamps, 7.8mm to 9.5mm range,   | 10 pcs |
| 143502    | Stepless Clamps, 9.6mm to 11.3mm range,  | 10 pcs |
| 142613    | Stepless Clamps, 10.3mm to 12.8mm range, | 10 pcs |
| 142614    | Stepless Clamps, 10.8mm to 13.3mm range, | 10 pcs |
| 142615    | Stepless Clamps, 12.0mm to 14.5mm range, | 10 pcs |
| 143503    | Stepless Clamps, 13.2mm to 15.7mm range, | 10 pcs |
| 142616    | Stepless Clamps, 14.8mm to 18.0mm range, | 10 pcs |
| 12-0073   | Side Jaw Pincer Tool                     |        |



143504 Fuel Line Fittings Kit 124.99 E

MARINE



# CHEMICALS

- accessories
- towables
- body
- controls
- electrical
- driveline
- engine
- fuel & intake
- chemicals
- tie downs
- tools
- towing & loading

When it's gotta' last,  
It's gotta be...



## S100 TOTAL CYCLE CLEANER

If you've been using a bucket of car suds or a quick detailer, chances are you been missing the most important and threatened places on your bike... those hidden nooks and crannies where dirt can hide. Why isn't that ok? Dirt traps moisture and the moisture can't dry out. The result is corrosion, rust and tarnish and you can't even see it happening! S100 Total Cycle Cleaner works differently by creeping to find the hidden soils you can't see, then penetrating and loosening them so a sharp stream of water can remove them. The result is a bike that is clean everywhere, not just where can see. Simply put, it's better for your bike. (You don't have to tell your friends it's quick too.)

| DESCRIPTION                               | QTY/CS | PART # |       |   |
|---|--------|--------|-------|---|
| 1 Liter Deluxe Kit                        | 12     | 650283 | 14.95 | G |
| 1 Liter Refill                            | 12     | 650284 | 12.95 | G |
| 5 Liter Canister                          | 2      | 650285 | 52.95 | G |
| 500 ml Starter                            | 12     | 650286 | 8.50  | G |
| 21 oz. Aerosol                            | 12     | 650287 | 11.95 | G |
| Sprayer for 5 Liter Canister w/6 ft. Hose | 1      | 650300 | 6.49  | G |

MARINE

## S100 SHINE-ENHANCING CLEANSER AND S100 CARNAUBA PASTE WAX

Ready to get the ultimate shine? Experts agree that waxes with cleaners in them are compromise products, that the cleansing and waxing steps must be done separately, so that's what we've done. Use our two step S100 Cleanser and S100 Paste Wax system, we can virtually guarantee you can put your bike in a show! Get your bike clean and dry, then begin with our S100 Shine-enhancing Cleanser. Professional painters and detailers agree that proper surface preparation is fundamental to getting the ultimate shine. The S100 Cleanser gently removes water spots, small swirl marks and imbedded road film to set up the surface for the ultimate shine, all without scratching even sensitive clear coats! Now you're ready for the ultimate wax job with our S100 Carnauba Paste Wax. Free of abrasives and cleaners and made with a unique blend of carnauba (the world's hardest wax) and beeswax, you will be amazed at the depth of shine and darkening of dark colored surfaces. And we've eliminated two common annoyances, powdering during rubout and white stain residues on plastics and rubber! And it's so easy to apply and remove, some bikers tell us it's as easy to use as a liquid!

| DESCRIPTION                      | QTY/CS | PART # |       |   |
|----------------------------------|--------|--------|-------|---|
| Shine Enhancing Cleanser, 350 ml | 12     | 650289 | 9.95  | G |
| Carnauba Paste Wax, 6.2 oz.      | 12     | 650288 | 16.95 | G |







**S100 DRYING TOWEL**

There's not much point in getting a bike washed quickly, if you can't get it dried quickly. That's why we introduced the amazing S100 Drying Towel. More drying power than a natural chamois, yet it never gets stiff so it's always ready to use. Lint free, it stores in its own plastic pouch so it's ready to pull out of the saddlebag. Made from 100% biodegradable materials without using CFC's or formaldehydes.



| DESCRIPTION           | QTY/CS | PART # |      |   |
|-----------------------|--------|--------|------|---|
| Super Absorbing Towel | 12     | 650290 | 9.95 | G |



**S100 WHEEL CLEANER**

Sometimes those road wheels need some extra cleaning power to get them back to that "like new" look. And, worse yet, that brake dust (it contains metallic particles!) can become corrosive if allowed to stand for awhile. If you find that brake dust build up is hard to keep up with, we recommend you try our S100 Special Performance Gel Wheel Cleaner. It provides up to 50% more cleaning power than our Total Cycle Cleaner thanks to the clinging power of its unique gel formulation. Spray on and allow to stand (you control the amount of cleaning you need, see directions on bottle), then rinse thoroughly. Neither acid, nor lye-based like cheaper products, S100 Wheel Cleaner provides complete surface safety for any type of wheel or wheel finish, including those tricky anodized finishes.

| DESCRIPTION | QTY/CS | PART # |      |   |
|-------------|--------|--------|------|---|
| 500 ml      | 12     | 650291 | 9.95 | G |

**S100 CORROSION PROTECTANT**

No matter how clean you keep your bike, you always have to be on the lookout for that dreaded "enemy number one", corrosion. Unless you live in the desert, humidity, salt air, spring road salt and plain old pollution threaten your bike's "precious metals". That's why we developed S100 Corrosion Protectant. Just spray on a clean, dry bike (or into a cloth) and rub into the areas you want to protect, those sensitive areas like fork tubes, case covers and wheels (and don't forget those hidden areas you can't reach.). You'll find that S100 Corrosion Protectant won't rub off easily in the rain and so its protection really lasts. It even dramatically out-performed a famous so called "corrosion fighter", so this is really the way to protect your investment!

Important note: This is the perfect product for winter lay up and long term storage. Spray directly on all sensitive areas and allow to dry.

| DESCRIPTION | QTY/CS | PART # |       |   |
|-------------|--------|--------|-------|---|
| 7.2 oz.     | 12     | 650292 | 10.50 | G |



- accessories
- towables
- body
- controls
- electrical
- driveline
- engine
- fuel & intake
- chemicals**
- tie downs
- tools
- towing & loading

MARINE

- accessories
- towables
- body
- controls
- electrical
- driveline
- engine
- fuel & intake
- chemicals**
- tie downs
- tools
- towing & loading



## S100 FINISH RESTORER AND S100 POLISHING SOAP

No matter how well you take care of your bike, sometimes things happen that need "intensive care". Some overly stubborn road film, a few ugly stains, or plain old dulling and corrosion are things a biker can face. No problem! For small areas, our S100 Finish Restorer is the perfect solution. It can renew tarnished metals (aluminum, stainless, chrome etc.) to a brilliant shine, even often take small scratches out of plastics. It rubs out easier than ordinary polishes and doesn't come with that ugly ammonia smell, either! No wonder Motorcyclist Magazine called it "the nearest article to a miracle finish maintenance product..."

For larger areas, our breakthrough polishing product S100 Polishing Soap is the perfect weapon in that fight against dulling and tarnishing. This just might be the world's fastest way to polish! Forget the slow, tedious two finger polishing you know and step up to a handful of polishing power. Based on a technology used by European silversmiths, this clay and soap based polish is applied with a wet sponge (included). Wet the sponge, drag across the Polishing Soap and scrub the surface. Rinse with a hose or let dry and buff out. No smelly, oily residue and a speed that will amaze you. Pipes, fork tubes, wheels, case covers etc. get shined up in a fraction of the time it used to take. Economical, too. Outlasts a couple of tubes of ordinary polish. (Not recommended for painted or anodized surfaces.). Dozens of uses around the home are described in the booklet included.

| DESCRIPTION               | QTY/CS | PART # |       |   |
|---------------------------|--------|--------|-------|---|
| Finish Restorer, 3.56 oz. | 15     | 650293 | 9.95  | G |
| Polishing Soap, 10.6 oz.  | 12     | 650299 | 10.50 | G |

## S100 DETAIL + WAX

OK, we know there are some times when your bike isn't really that filthy, maybe just a bit dusty, rain-spotted or covered with bugs. We've got something for that, too. S100 Detail + Wax removes that dust, those spots, and the bug residue. And its unique carnauba and beeswax ingredients replace them with a "gangbusters" shine. Just think of it as a wash and wax in one! It's easy to use, too. Just spray a bit on a soft cloth or onto the bike's surface and rub to a high gloss. Pack a can in the saddlebag and you're ready for a dusty road or that surprise rain shower. No wonder an independent test rated S100 Detail + Wax "... the most consistent performer of all".

| DESCRIPTION | QTY/CS | PART # |      |   |
|-------------|--------|--------|------|---|
| 10 oz.      | 12     | 650294 | 9.49 | G |



MARINE



## S100 ENGINE BRIGHTENER

Got a bike with a black engine that just isn't so black anymore? Bikers like you told us they needed special help in this area and we listened! Our S100 Engine Brightener can take a tired, greyed-out engine and make it look almost factory-new again! Just clean the engine and dry, then spray on our temperature stable S100 Engine Brightener. Use the handy misting spray nozzle (an industry exclusive) to get into the cooling fins and crannies without over-applying. That factory black look comes back and lasts for miles and miles and holds up to a bunch of washes, too. Friends will think you replaced the engine!

| DESCRIPTION | QTY/CS | PART # |      |   |
|-------------|--------|--------|------|---|
| 4.5 oz.     | 12     | 650295 | 8.95 | G |



**S100 CARE SET**

Now here's the ultimate care package for someone who owns a special bike. This really is a gift that keeps on giving! A perfectly organized set that contains and organizes the key items a biker needs to keep his steel in the best shape possible. Five top selling S100 products in a perfect carry-organizer. The perfect start for the ultimate in bike care!



| DESCRIPTION         | QTY/CS | PART # |         |
|---------------------|--------|--------|---------|
| Cycle Care Gift Set | 4      | 650296 | 59.95 G |

- accessories
- towables
- body
- controls
- electrical
- driveline
- engine
- fuel & intake
- chemicals**
- tie downs
- tools
- towing & loading



**S100 DETAILING SET AND S100 DETAILING SWABS**

If you're fussy about caring for your bike, it's important not to skip the details! The S100 Detailing Set enables you to get into those tough to reach nooks and crannies. The 25 USP grade swabs are so flexible they can be bent 90° to reach around corners. Use them to apply other S100 products such as S100 Total Cycle Cleaner or S100 Corrosion Protectant, too. The S100 Detailing Set also includes an ultra-soft polishing cloth for dusting, rubbing out polishes, waxes, etc. Refill the Detailing Set with the 50 piece Detailing Swabs pack.

| DESCRIPTION     | QTY/CS | PART # |         |
|-----------------|--------|--------|---------|
| Detailing Set   | 12     | 650297 | 9.49 G  |
| Detailing Swabs | 12     | 650298 | 10.50 G |



**S100 SPECIAL SURFACES CLEANER**

Dirty, dull plastics ruin the look of a bike. New S100 Special Surfaces Cleaner is a waterless spray-on, wipe off cleaner that cleans up fairings, helmets, visors, instruments and windshields in seconds. Bugs, rain spots and road film disappear instantly leaving nothing but a nice clear surface! Here's what some bikers said: "...used on my helmet visor...it appears so clear it seemed like I didn't have my visor down". "I was amazed how it gave back life to the cover on the speed and tach gauges." Safe for use on polycarbonate and acrylics such as Lexan®, Lucite®, Plexiglas®, fiberglass, etc. Perfect to take along in the saddlebag.

| DESCRIPTION | QTY/CS | PART # |         |
|-------------|--------|--------|---------|
| 300 ml      | 12     | 650301 | 10.50 G |



MARINE

## BIKE MAGIK MOTORCYCLE CLEANERS

Motorcycle detailing products from Bio-Kleen specifically designed to produce the best looking bike in the least amount of time. Cleaners manufactured keeping all motorcycle riders and the environment under consideration, providing the best in performance and safety, the same qualities you expect out of your bike. Bike Magik motorcycle cleaners allow you to clean, shine and protect your entire motorcycle in just minutes with bike wash, bike cleaner, motorcycle polish, metal polish - exhaust polish and more.



### BIKE MAGIK QWIK KLEEN DEGREASER

**Bike Magik Qwik Kleen Degreaser is a spray on, wipe off motorcycle cleaner degreaser.**

- Cleans those hard to get boot and scuff marks off your motorcycle pipes.
- Quickly cleans heavy grease, carbon and petroleum deposits, oil, black streaks and regular build up from bike.
- Black exhaust on rear fenders and greasy road dirt on the bike frame is cleaned instantly.
- High performance cleaning and degreasing for all motorcycle, bikes, motorcross, ATV, UTV, engines, painted surfaces, plastic, fiberglass, parts, tools, chrome, stainless steel, wheels and trailers. Great for clean ups in the garage.



4 oz size also available (not pictured)

| DESCRIPTION | QTY/CS | PART # |       |   |
|-------------|--------|--------|-------|---|
| 4 oz        | 12     | 700101 | 5.95  | G |
| 32 oz       | 12     | 700104 | 15.95 | G |



available in 4oz size only (not pictured)

### BIKE MAGIK QWIK SHINE

**Bike Magik Qwik Shine is a motorcycle detailing spray and quick bike wax.**

- Spray On Shine and Leather Protectant
- Great for On The Road Touch Ups and Detailing
- Clean, Shine and Protect Without Washing Motorcycle
- Helps Repel Water and Dust from Motorcycle Finish
- The secret to a perpetual brilliant shine. Spray away water spots, insects, bird hits, fingerprints and road dust in minutes.
- Enhances the depth of shine and a micro thin layer of polymer protection every time used.
- Preserves and restores motorcycle leather and vinyl adding UV protection.
- No rinsing and no residue for a qwik shine every time.

| DESCRIPTION | QTY/CS | PART # |      |   |
|-------------|--------|--------|------|---|
| 4 oz        | 12     | 700102 | 6.95 | G |

### BIKE MAGIK SUPER SUDS

**Bike Magik Super Suds is a Motorcycle, Bike, Scooter, ATV Wash.**

- This supercharged liquid concentrate quickly removes road grime, insects, oil and water spots.
- The rich high foam rinses freely, leaving a clean, streak free bike finish.
- Cleans without removing Bike Magik Polish & Sealant or regular waxes.
- Fortified with enzymes to safely and effectively break down and remove insect debris.
- Specially incorporated polymers leave behind added protection and shine.
- Use on: motorcycles, dirt bikes, scooters, ATV, UTV, trailers, car, truck, rv and siding.

available in 4oz size only (not pictured)



| DESCRIPTION | QTY/CS | PART # |      |   |
|-------------|--------|--------|------|---|
| 4 oz        | 12     | 700103 | 5.95 | G |

- accessories
- towables
- body
- controls
- electrical
- driveline
- engine
- fuel & intake
- chemicals
- tie downs
- tools
- towing & loading

- accessories
- towables
- body
- controls
- electrical
- driveline
- engine
- fuel & intake
- chemicals**
- tie downs
- tools
- towing & loading

## SLEDBRITE SNOWMOBILE CLEANERS

SledBrite snowmobile cleaners are a complete line of superior, fast and effective snowmobile cleaning products specifically designed for snowmobiles; quickly clean and efficiently maintain your sled, snowmobile gear, sled trailer and snowmobile accessories. Make snowmobile tunnel cleaning and snowmobile tunnel polishing quick and easy with SledBrite snowmobile cleaners. Simply spray and wipe to remove those tough, black exhaust stains and carbon deposits from your sled and snowmobile belly pan.

SledBrite snowmobile cleaners are used and recommended by respected professionals in the snowmobile industry: Ski-doo premier snocross team BOSS Racing, Christian Brothers Racing snocross team, Warnert Racing snocross team, Stud Boy traction and their factory racing team and Jason Dunigan and Dunigan Racing teams for snowmobile drag racing. SledBrite snowmobile cleaners are the only non-private label products distributed by Arctic Cat in both their snowmobile and ATV catalogs. SledBrite snowmobile cleaners have been featured in all of the top snowmobile magazines including: SnowTech, American Snowmobiler, Snow Goer, Supertraxx and Sno-X.



## SLEDBRITE METAL POLISH

### Polish Snowmobile Tunnels & Metal

- Removes Dullness from Tunnel and Metal
- Creates a Brilliant Shine
- Seals the Metal for Protection

| DESCRIPTION | QTY/CS | PART # |      |   |  |
|-------------|--------|--------|------|---|--|
| 2 oz        | 20     | 700105 | 8.95 | G |  |



| DESCRIPTION | QTY/CS | PART # |       |   |  |
|-------------|--------|--------|-------|---|--|
| 4 oz        | 12     | 700106 | 5.95  | G |  |
| 32 oz       | 12     | 700110 | 13.95 | G |  |

## SLEDBRITE KRYSTAL VIEW

### Snowmobile Goggles Anti Fog Cleaner

- Glass, Goggle Cleaner
- Anti Fog Lens Cleaner
- Snowmobile Helmet Cleaning
- Snowmobile Windshield Cleaning
- Non toxic, Biodegradable, Non Aerosol, Ozone Safe

## SLEDBRITE LEATHER, VINYL, FABRIC

### Snowmobile Vinyl Fabric Leather Cleaner

- Vinyl Cleaner, Fabric Cleaner, Leather Cleaner
- Safely Removes Stains from Snowmobile Seats, Suits, Gloves, Helmet Liner & More
- Leather Jacket Cleaner, Suede Cleaner, Clothing Cleaner
- Non toxic, Biodegradable, Non Aerosol, Ozone Safe

| DESCRIPTION | QTY/CS | PART # |      |   |  |
|-------------|--------|--------|------|---|--|
| 4 oz        | 12     | 700107 | 5.95 | G |  |



| DESCRIPTION | QTY/CS | PART # |       |   |  |
|-------------|--------|--------|-------|---|--|
| 16 oz       | 12     | 700108 | 8.95  | G |  |
| 32 oz       | 12     | 700109 | 15.95 | G |  |

## SLEDBRITE BELLY PAN CLEANER

### Snowmobile Belly Pan Cleaner Degreaser

- Clean Black Exhaust Stain from Snowmobile and Snowmobile Parts
- Safe on Sled Decals and Plastic
- Clean Snowmobile Belly Pan, Belts, Clutches, Equipment
- Non toxic, Biodegradable, Non Aerosol, Ozone Safe

## BIO-KLEEN ENVIRONMENTALLY FRIENDLY CLEANERS



### BiokleenGreen

American made, biodegradable cleaning products since 1987: guaranteed to outperform leading brands and help maintain a clean, healthy and sustainable lifestyle.

### Our Goal

Bio-Kleen's number one goal is to provide effective products that are safe for the user and the environment. We strive to make each of our products adhere to the standards below without compromising efficacy.

### The Products

Biodegradable, Non-Toxic Cleaning Solutions Produced with the most Natural, Premium, Renewable and Non-Petroleum based ingredients for each application. All products are Non-Aerosol and Ozone Safe.

## BIO-KLEEN POLISHING BALL

### Buffing Polishing Ball

- Drastically reduce your polishing time
- Polish hard to reach areas
- Soft, yet durable fibers made to last
- Polish a wide range of metals and surfaces
- Connects to any common drill

| DESCRIPTION      | QTY/CS | PART # |       |   |  |
|------------------|--------|--------|-------|---|--|
| 1 Polishing Ball | 24     | 700100 | 15.95 | G |  |



| DESCRIPTION | QTY/CS | PART # |       |   |  |
|-------------|--------|--------|-------|---|--|
| 32 oz       | 12     | 700111 | 19.95 | G |  |

## BIO-KLEEN H2O REPEL

### Waterproof Canvas, Fabric and Carpet

- Professional Water Repellent and Fabric Protectant
- Repels Moisture
- No Discoloration
- Leaves the surface flexible and breathable
- Great for Outerwear, Carpet, Boots, Tents, Canvas and More

## BIO-KLEEN POLISH & SEALANT

### Boat Wax Marine Polish

- The Ultimate Shine & Protection Polish Wax
- Deep Cleans and Restores Color
- Polish, Seal & Protect in One Application

| DESCRIPTION | QTY/CS | PART # |       |   |  |
|-------------|--------|--------|-------|---|--|
| 4 oz        | 12     | 700112 | 9.95  | G |  |
| 16 oz       | 12     | 700121 | 29.95 | G |  |



| DESCRIPTION | QTY/CS | PART # |       |   |  |
|-------------|--------|--------|-------|---|--|
| 4 oz        | 12     | 700113 | 15.95 | G |  |

## BIO-KLEEN RENEW

### Metal Polish & Headlight Restoration

- Fast drying liquid metal polish
- Polishes metals to a brilliant shine
- Quickly polish all metal surfaces fast
- Restores plastic cloudy-yellow headlight lens
- Professional restoration product for fiberglass



## BIO-KLEEN

### BIO-KLEEN ALUMA KLEEN

**Aluminum Cleaner and Brightener for Boat | RV | Auto**

- Removes oxidation, stains and discoloration
- Clean diamond plate on RV or Boat
- Cleans aluminum boats and pontoons
- Clean rims and running boards on vehicles
- Non toxic, Biodegradable, Non Aerosol, Ozone Safe

| DESCRIPTION | QTY/CS | PART # |       |   |
|-------------|--------|--------|-------|---|
| 16 oz       | 12     | 700114 | 8.95  | G |
| 32 oz       | 12     | 700122 | 15.95 | G |



| DESCRIPTION | QTY/CS | PART # |       |   |
|-------------|--------|--------|-------|---|
| 16 oz       | 12     | 700115 | 9.95  | G |
| 32 oz       | 12     | 700123 | 16.95 | G |

### BIO-KLEEN AMAZING CLEANER

**Boat Vinyl Cleaner | All Purpose Vinyl, Leather, Fabric & More**

- Cleans Vinyl, Leather, Fabric, Boats, RVs and More
- Lifts dirt and stains from vinyl and fabric
- Breaks down insect debris on vehicles
- Remove the chalk residue on rubber RV roofs
- Remove mold and mildew stains on canvas and more
- Non toxic, Biodegradable, Non Aerosol

| DESCRIPTION | QTY/CS | PART # |       |   |
|-------------|--------|--------|-------|---|
| 16 oz       | 12     | 700116 | 8.95  | G |
| 32 oz       | 12     | 700124 | 15.95 | G |



| DESCRIPTION | QTY/CS | PART # |       |   |
|-------------|--------|--------|-------|---|
| 16 oz       | 12     | 700117 | 9.95  | G |
| 32 oz       | 12     | 700127 | 16.95 | G |

### BIO-KLEEN OXIDATION REMOVER

**Cleans the Yellow Water Line from Boat Hull & Dull, Chalked Paint from RV**

- Designed to remove the yellow water line and stains from fiberglass boat hulls
- Removes dull, chalkiness from RVs
- Removes spider droppings from boat and RV
- Non toxic, Biodegradable, Non Aerosol

| DESCRIPTION | QTY/CS | PART # |       |   |
|-------------|--------|--------|-------|---|
| 16 oz       | 12     | 700118 | 8.95  | G |
| 32 oz       | 12     | 700129 | 15.95 | G |



### BIO-KLEEN AMAZING ARMOR

**Vinyl Conditioner, Leather Protectant, Tire Shine for Boat | RV | Auto**

- Conditions and Renews Vinyl, Leather, Rubber & More
- Guards Against Ozone, Ultraviolet Rays and Cracking
- Sealant Protection for Rubber RV roof
- Non toxic, Biodegradable, Non Aerosol



### BIO-KLEEN FIBERGLASS CLEANER

**Hull Cleaner and RV Fiberglass Cleaner**

- Ideal for Marine and RV Fiberglass, Metals and Anodes
- Remove chalking, algae, rust, scale, lime, oxidation from boat hull
- Remove yellowing, oxidation, chalking from fiberglass RV
- Non toxic, Biodegradable, Non Aerosol



accessories

towables

body

controls

electrical

driveline

engine

fuel & intake

chemicals

tie downs

tools

towing & loading

MARINE

- accessories
- towables
- body
- controls
- electrical
- driveline
- engine
- fuel & intake
- chemicals**
- tie downs
- tools
- towing & loading



## BIO-KLEEN

### BIO-KLEEN QUIK SHINE

#### Spray Wax Detailing Spray

Spray On Polymer Polish Wax  
UV Protection with SPF 40

Quickly remove dust, smudges, bird hits and water spots  
A spray on, wipe off formula that cleans and shines  
Non toxic, Biodegradable, Non Aerosol, Ozone Safe

| DESCRIPTION | QTY/CS | PART # |         |
|-------------|--------|--------|---------|
| 16 oz       | 12     | 700119 | 8.95 G  |
| 32 oz       | 12     | 700130 | 15.95 G |



| DESCRIPTION | QTY/CS | PART # |         |
|-------------|--------|--------|---------|
| 32 oz       | 12     | 700125 | 15.95 G |

### BIO-KLEEN BILGE CLEANER

#### Bilge Cleaner

- Dissolves any Sludge, Grease or Soils in Your Marine Bilge
- A neutral pH emulsion cleaner/degreaser
- Contains a quaternary sanitizer to keep bilge and live well fresh
- Non toxic, Biodegradable, Non Aerosol

### BIO-KLEEN BLACK STREAK REMOVER

#### RV Marine Black Streak Remover

- Remove Black Streaks and Stains with Ease
- Multi Purpose Cleaner Degreaser
- Black Streaks, Oil Stains, Grease and More
- RVs, Boats, Trailers, Garage & More
- Simple and Safe: Spray-on, Wipe Clean
- Non toxic, Biodegradable, Non Aerosol

| DESCRIPTION | QTY/CS | PART # |         |
|-------------|--------|--------|---------|
| 32 oz       | 12     | 700126 | 15.95 G |



| DESCRIPTION | QTY/CS | PART # |         |
|-------------|--------|--------|---------|
| 32 oz       | 12     | 700128 | 11.95 G |

### BIO-KLEEN HULL KLEEN

#### Aggressive, One Step Hull Cleaner

- Commercial Strength, One Step, Brush On, Spray Off Hull Cleaner
- Quickly Removes Algae, Lime, Scale & Chalking
- Safer alternative to harsh acids and chemicals
- Safe on Aluminum and Pontoons
- Biodegradable, Non Aerosol

### BIO-KLEEN REMOVE ALL

#### Engine Degreaser, Tar Remover

- Powerful Engine Degeaser
- Remove Road Tar from Car
- Rinses Away Easily

| DESCRIPTION | QTY/CS | PART # |          |
|-------------|--------|--------|----------|
| 32 oz       | 12     | 700131 | 19.95 AE |



MARINE





## BIO-KLEEN

### BIO-KLEEN RESTORE & SHINE

#### Fiberglass & Paint Restoration Compound

- One Step Liquid Compound & Polish in One
- Restores Color in Faded Fiberglass
- 250 degree F UVA/UVB Protection
- Removes Swirl Marks & Light Oxidation
- Contains No Silicone
- VOC Compliant

| DESCRIPTION | QTY/CS | PART # |       |   |
|-------------|--------|--------|-------|---|
| 32 oz       | 12     | 700132 | 50.00 | G |



| DESCRIPTION | QTY/CS | PART # |       |   |
|-------------|--------|--------|-------|---|
| 32 oz       | 12     | 700133 | 50.00 | G |

### BIO-KLEEN RESTORE & SHINE XTRA CUT

#### Extra Cut Fiberglass & Paint Restoration Compound

- Liquid Compound & Polish in One
- Restores Color in Faded Fiberglass
- Removes Light Scratches & Oxidation
- 250 degree F UVA/UVB Protection
- Contains No Silicone
- VOC Compliant



### BIO-KLEEN SALT KLEEN

#### Salt Neutralizer | Marine | RV | Auto | Commercial

- Remove salt build up, deposits and road salt from any surface
- Salt is quickly neutralized, released and removed
- Protection against rust and salt corrosion
- Non toxic, Biodegradable, Non Aerosol

| DESCRIPTION | QTY/CS | PART # |      |   |
|-------------|--------|--------|------|---|
| 32 oz       | 12     | 700134 | 9.95 | G |



| DESCRIPTION | QTY/CS | PART # |       |   |
|-------------|--------|--------|-------|---|
| 32 oz       | 12     | 700135 | 15.95 | G |

### BIO-KLEEN SUPER SUDS

#### Liquid Boat RV Vehicle Wash

- Super concentrated liquid wash for Boats, RV and Auto
- Quickly removes scum lines, dirt, grime, insects and water spots
- Leave behind added protection and shine
- Phosphate Free, Non toxic, Biodegradable, Non Aerosol

### BIO-KLEEN WHEEL GEL

#### Tire, Wheel and All Rim Cleaner

- Safely Clean Tires, Wheels and All Rim Types
- Clean Brake Dust from Wheels
- Clean Rail Dust from Car Exterior
- Non toxic, Biodegradable, Non Aerosol

| DESCRIPTION | QTY/CS | PART # |       |   |
|-------------|--------|--------|-------|---|
| 32 oz       | 12     | 700136 | 16.95 | G |



### BIO-KLEEN GLASS KLEEN

#### Glass and Surface Cleaner

- Clean Glass, Windows, Mirrors, Chrome and Counters
- Wipes Away Clean and Streak Free
- Ammonia Free
- Non toxic, Biodegradable, Non Aerosol, Ozone Safe

| DESCRIPTION | QTY/CS | PART # |      |   |
|-------------|--------|--------|------|---|
| 32 oz       | 12     | 700137 | 7.95 | G |



accessories

towables

body

controls

electrical

driveline

engine

fuel & intake

chemicals

tie downs

tools

towing & loading

MARINE

- accessories
- towables
- body
- controls
- electrical
- driveline
- engine
- fuel & intake
- chemicals
- tie downs
- tools
- towing & loading



## MAXIMA



### MAXUM4 BLEND

Our synthetic/petroleum blend contains over 50% synthetic base stocks and advanced additives for high performance 4-cycle engines. Anti-shear additives provide outstanding viscosity stability in all integrated transmission engines. API SG/CC motorcycle specific MA oil. Sold per bottle.

| DESCRIPTION         | QTY/CS | PART # |       |   |
|---------------------|--------|--------|-------|---|
| 10w40 Liter Bottle  | 12     | 930016 | 10.50 | G |
| 20w50 Liter Bottle  | 12     | 930020 | 10.50 | G |
| 10w40 128 oz Bottle | 4      | 930092 | 36.95 | G |
| 20w50 128 oz Bottle | 4      | 930093 | 36.95 | G |

Maxima's Maxum4 Extra is 100% synthetic motor oil featuring advanced additive technology. By using today's most advanced additive systems and high-performance synthetic ester based stocks, we have engineered what we believe to be the finest 4-cycle motorcycle specific oil available on the market today. The very latest shear stable polymer systems have been used to assure viscosity stability and virtually eliminate transmission "shear-down" of the oil. Sold per bottle.

### MAXUM4 SYNTHETIC EXTRA

| DESCRIPTION         | QTY/CS | PART # |       |   |
|---------------------|--------|--------|-------|---|
| 10w40 Liter Bottle  | 12     | 930014 | 16.50 | G |
| 15w50 Liter Bottle  | 12     | 930015 | 16.50 | G |
| 10w40 128 oz Bottle | 4      | 930084 | 59.95 | G |
| 10w60 Liter Bottle  | 12     | 930085 | 17.95 | G |
| 10w60 128 oz Bottle | 4      | 930086 | 64.95 | G |
| 15w50 128 oz Bottle | 4      | 930087 | 59.95 | G |
| 0w10 Liter Bottle   | 12     | 930088 | 17.95 | G |
| 0w10 128 oz Bottle  | 4      | 930089 | 64.95 | G |
| 5w40 Liter Bottle   | 12     | 930090 | 17.95 | G |
| 5w40 128 oz Bottle  | 4      | 930091 | 64.95 | G |



### MAXUM4 PREMIUM

Petroleum blend features advanced high performance 4-cycle engine additives. Antishear additives provide excellent viscosity stability in engines with integrated transmissions. API SG/CD motorcycle specific MA oil. Sold per bottle.

| DESCRIPTION         | QTY/CS | PART # |       |   |
|---------------------|--------|--------|-------|---|
| 5w30 Liter Bottle   | 12     | 930021 | 7.95  | G |
| 10w40 Liter Bottle  | 12     | 930017 | 7.95  | G |
| 10w40 Gallon Bottle | 4      | 930018 | 27.95 | G |
| 20w50 Liter Bottle  | 12     | 930019 | 7.95  | G |
| 20w50 Gallon Bottle | 4      | 930022 | 27.95 | G |
| 5w30 128 oz Bottle  | 4      | 930094 | 27.95 | G |





## MAXIMA

### 530MX

530MX is a 100% Tri-Ester based synthetic oil. Developed on the world's toughest race circuits, 530MX produces more horsepower, increased torque and excellent clutch feel – there is no better choice for modern MX/Offroad motorcycles. Advanced additives ensure the ultimate in protection for critical engine, transmission and clutch components. High temperature detergents keep your engine running clean and trouble-free, while the ultra shear-stable polymer system maintains constant viscosity – minimizing viscosity loss and clutch fade.

| DESCRIPTION         | QTY/CS | PART # |       |   |
|---------------------|--------|--------|-------|---|
| 5w30 Liter Bottle   | 12     | 930037 | 18.50 | G |
| 10w40 Liter Bottle  | 12     | 930095 | 7.95  | G |
| 10w40 128 oz Bottle | 4      | 930096 | 27.95 | G |



### 530RR

530RR is a 100% Tri-Ester based synthetic oil. Developed on the world's toughest race circuits, 530RR produces more horsepower, increased torque and excellent clutch feel – there is no better choice for modern hi-revving road racing motorcycles. Advanced additives ensure the ultimate in protection for critical engine, transmission and clutch components. High temperature detergents keep your engine running clean and trouble-free, while the ultra shear-stable polymer system maintains constant viscosity – minimizing viscosity loss and clutch fade.

| DESCRIPTION       | QTY/CS | PART # |       |   |
|-------------------|--------|--------|-------|---|
| 5w30 Liter Bottle | 12     | 930038 | 18.50 | G |

### PRO PLUS+

PRO PLUS+ is an ester fortified full synthetic 4T engine oil. PRO PLUS+ is formulated to exceed JASO MA requirements for 4-cycle engines with integrated wet clutches. Balanced additive system minimizes engine deposits while protecting critical engine, transmission and clutch components. PRO PLUS+ is designed to prolong engine and wet clutch life and offers excellent feel. For maximum protection and reliability use Maxima Racing Oils. Meets or exceeds JASO MA, API SL/SJ/SH/SG

| DESCRIPTION         | QTY/CS | PART # |       |   |
|---------------------|--------|--------|-------|---|
| 10w30 Liter Bottle  | 12     | 930078 | 12.95 | G |
| 10w30 128 oz Bottle | 4      | 930079 | 44.95 | G |
| 10w40 Liter Bottle  | 12     | 930080 | 12.95 | G |
| 10w40 128 oz Bottle | 4      | 930081 | 44.95 | G |
| 20w50 Liter Bottle  | 12     | 930082 | 12.95 | G |
| 20w50 128 oz Bottle | 4      | 930083 | 44.95 | G |



### SUPER-M

Smokeless, clean burning, synthetic/petroleum blend utilizing the latest additive system technology. Designed for use in high performance 2-cycle engines. Exceeds BIA/TC, JASO-FC and ISO-E-GD specifications. Sold per bottle.

| DESCRIPTION  | QTY/CS | PART # |       |   |
|--------------|--------|--------|-------|---|
| 16 oz Bottle | 12     | 930001 | 8.50  | G |
| Liter Bottle | 12     | 930000 | 14.95 | G |
| 64 oz Bottle | 6      | 930002 | 26.95 | G |



### SUPER-M INJECTOR

Lighter weight version of SuperM specifically for oil injected 2-cycle engines. Smokeless, clean burning synthetic/petroleum blend. Exceeds BIA/TC, JASO-FC and ISO-E-GD specifications. Sold per bottle.

| DESCRIPTION   | QTY/CS | PART # |       |   |
|---------------|--------|--------|-------|---|
| Gallon Bottle | 4      | 930003 | 48.95 | G |
| Liter Bottle  | 12     | 930105 | 14.95 | G |



- accessories
- towables
- body
- controls
- electrical
- driveline
- engine
- fuel & intake
- chemicals
- tie downs
- tools
- towing & loading

MARINE



## MAXIMA

### PWC MARINE 4T OIL

This oil is specially formulated to perform in 4-cycle watercraft engines. It utilizes the latest additive technology ensuring a smooth, clean running engine. Advanced chemistry helps protect the engine from extreme pressures, scuffing, runaway temperatures, thermal degradation and rust & corrosion. PWC Marine specific formula. Sold per bottle.



| DESCRIPTION        | QTY/CS | PART # |      |   |
|--------------------|--------|--------|------|---|
| 10w40 Liter Bottle | 12     | 930013 | 8.25 | G |

### MAXUM4 CLASSIC

Maxum4 Classic is an exclusive blend of petroleum base stocks and high load anti-wear, anti-shear and liquid moly additives. This formula is designed to handle extreme loads at peak temperatures in high performance air-cooled 4-cycle engines. Maxum4 Classic assures viscosity stability and reduces bearing wear on cams lifters and other critical engine parts. Our proven formula is temperature resistant and delivers optimum engine cleanliness while exceeding manufacturer's requirements for engine lubrication.

| DESCRIPTION         | QTY/CS | PART # |      |   |
|---------------------|--------|--------|------|---|
| 60 wt. Liter Bottle | 12     | 930099 | 8.95 | G |
| 70 wt. Liter Bottle | 12     | 930100 | 8.95 | G |



### PREMIUM 2

Smokeless, clean burning, ash less synthetic blend recommended for premix or injected 2-cycle engine use. Exceeds all OEM and BIA/TC-W3 standards. Sold per bottle.

| DESCRIPTION   | QTY/CS | PART # |       |   |
|---------------|--------|--------|-------|---|
| Liter Bottle  | 12     | 930004 | 14.95 | G |
| 128 oz Bottle | 4      | 930106 | 49.95 | G |



### CASTOR 927

The ultimate lubricant for high performance 2-cycle racing engines. Special additives prevent rust and oxidation, ring sticking and carbon build-up. For premix only. Sold per bottle.

| DESCRIPTION  | QTY/CS | PART # |       |   |
|--------------|--------|--------|-------|---|
| 16 oz Bottle | 12     | 930007 | 10.50 | G |
| Liter Bottle | 12     | 930006 | 19.95 | G |
| 64 oz Bottle | 6      | 930008 | 36.95 | G |



### BIO 2T

BIO 2T is a biodegradable high-performance 100% ester-based synthetic lubricant. BIO 2T is a highly advanced formula containing special clean-burn additives to eliminate deposits and control exhaust port blockage. BIO 2T reduces power valve maintenance, prevents rust and corrosion and eliminates ring sticking. BIO 2T is designed to minimize wear and maintenance providing outstanding anti-wear and anti-scuff protection, improved lubricity and promotes engine cleanliness. Superior additive system provides unsurpassed high temperature, high speed protection for critical engine components.

| DESCRIPTION  | QTY/CS | PART # |       |   |
|--------------|--------|--------|-------|---|
| Liter Bottle | 12     | 930109 | 21.95 | G |



accessories

towables

body

controls

electrical

driveline

engine

fuel & intake

chemicals

tie downs

tools

towing & loading

MARINE



## MAXIMA

### FORMULA K2

100% synthetic ester very high performance 2-cycle lubricant. Special additives reduce power valve maintenance, prevent rust and oxidation, ring sticking and carbon build-up. Premix only. Sold per bottle.

| DESCRIPTION  | QTY/CS | PART # |       |   |
|--------------|--------|--------|-------|---|
| Liter Bottle | 12     | 930005 | 19.95 | G |
| 16 oz Bottle | 12     | 930103 | 10.95 | G |
| 64 oz Bottle | 6      | 930104 | 36.95 | G |



### MARINE PRO

Petroleum based 2-cycle oil formulated for personal watercraft and outboard engines. Provides excellent rust and corrosion protection. Exceeds TC-W3 specs - NMMA certified. Sold per bottle.

| DESCRIPTION   | QTY/CS | PART # |       |   |
|---------------|--------|--------|-------|---|
| 128 oz Bottle | 4      | 930012 | 41.50 | G |
| Liter Bottle  | 12     | 930107 | 11.95 | G |



### SYNTHETIC GEAR OIL 75W90

Advanced 100% synthetic GL-5 gear oil for use in shaft drive motorcycles equipped with a separate transmission and/or chain case. Provides excellent anti-wear, rust and corrosion protection. Sold per each.

| DESCRIPTION  | QTY/CS | PART # |       |   |
|--------------|--------|--------|-------|---|
| Liter Bottle | 12     | 930030 | 19.95 | G |



### COOL-AIDE COOLANT

Cool-Aide is formulated to reduce engine temperatures and provides significantly better contact on heat transfer. Cool-Aide comes in a powerful 16 oz concentrate. Cool-Aide is for race use and does not offer freeze protection. Approved for race use on paved surfaces. Sold per bottle.

| DESCRIPTION       | QTY/CS | PART # |      |   |
|-------------------|--------|--------|------|---|
| 16 oz Concentrate | 12     | 930060 | 8.95 | G |
| 64 oz Concentrate | 6      | 930127 | 8.95 | G |



### PREMIUM GEAR OIL 80W90

Specially formulated for use in high performance shaft drive motorcycles. Provides excellent anti-wear, rust and corrosion protection. Sold per bottle.

| DESCRIPTION  | QTY/CS | PART # |       |   |
|--------------|--------|--------|-------|---|
| Liter Bottle | 12     | 930029 | 10.95 | G |

- accessories
- towables
- body
- controls
- electrical
- driveline
- engine
- fuel & intake
- chemicals
- tie downs
- tools
- towing & loading

MARINE



## MAXIMA

### COOLANOL

Ready-to-use 50/50 blend of premium antifreeze and deionized water. Specially blended for use in aluminum or magnesium motorcycle and ATV radiators and cooling systems. Sold per bottle.



| DESCRIPTION  | QTY/CS | PART # |       |   |
|--------------|--------|--------|-------|---|
| 64 oz Bottle | 6      | 930059 | 15.50 | G |

### BREAK-IN OIL

- This product is specifically designed for breaking in engines with flat tappet camshafts, roller elements or where elevated levels of anti-wear additives are needed.
- Advanced technology provides optimum ring seal.
- It is formulated with high levels of Zinc, Phosphorous & Sulfur in highly refined mineral base oil.
- Complex Zinc structure activates at lower temperatures & offers more protection at elevated temperatures.
- 2X Zinc Formula.
- Unsurpassed Protection During Engine Break-In.
- Fully Formulated 10w30.

| DESCRIPTION        | QTY/CS | PART # |      |   |
|--------------------|--------|--------|------|---|
| 10w30 Liter Bottle | 12     | 930074 | 8.95 | G |

### FUEL STABILIZER

Maxima Fuel Storage Stabilizer doubles as a fuel stabilizer and corrosion inhibitor. Not all brands offer protection from the harmful effects of ethanol and moisture contained in the fuel system. Maxima Fuel Storage Stabilizer conditions the fuel to help prevent the formation of lacquers and varnish caused by fuel degradation. Additionally, Maxima Fuel Storage Stabilizer fights corrosion within the entire fuel system - Keep your system protected.



| DESCRIPTION  | QTY/CS | PART # |       |   |
|--------------|--------|--------|-------|---|
| 32 oz Bottle | 12     | 930126 | 13.95 | G |

### FUEL STORAGE STABILIZER

Maxima Fuel Storage Stabilizer doubles as a fuel stabilizer and corrosion inhibitor. Not all brands offer protection from the harmful effects of ethanol and moisture contained in the fuel system. Maxima Fuel Storage Stabilizer conditions the fuel to help prevent the formation of lacquers and varnish caused by fuel degradation. Additionally, Maxima Fuel Storage Stabilizer fights corrosion within the entire fuel system - Keep your system protected.

| DESCRIPTION | QTY/CS | PART # |      |   |
|-------------|--------|--------|------|---|
| 8 oz Bottle | 12     | 930068 | 4.95 | G |

### FUEL SYSTEM DE-ICER

Eliminates moisture and condensation in motorcycle, ATV and snowmobile fuel systems. Enables gas to flow freely in severely cold conditions and is completely safe for all fuel systems. Does not contain methanol. Sold per bottle.

| DESCRIPTION | QTY/CS | PART # |      |   |
|-------------|--------|--------|------|---|
| 8 oz Bottle | 12     | 930067 | 4.50 | G |



- accessories
- towables
- body
- controls
- electrical
- driveline
- engine
- fuel & intake
- chemicals
- tie downs
- tools
- towing & loading



## MAXIMA

### HIGH TEST OCTANE BOOSTER

Concentrated octane booster increases pump gasoline octane rating. Eliminates "pinging" and "knocking" and their potentially destructive results. Legal for all racing applications. Sold per bottle.



| DESCRIPTION  | QTY/CS | PART # |      |   |
|--------------|--------|--------|------|---|
| 16 oz Bottle | 12     | 930064 | 6.50 | G |



### CLEAN UP

Multi-purpose spray-on cleaner was created for use on motorcycles, ATVs and personal watercraft. Highly effective emulsion formula contains no caustic chemicals. Removes oil, grease, road tar and other contaminants. Safe for use on plastics, painted surfaces, rubber, alloy and chrome. Sold per can.



| DESCRIPTION       | QTY/CS | PART # |      |   |
|-------------------|--------|--------|------|---|
| 20 oz Aerosol Can | 12     | 930058 | 9.50 | G |

### AIR FILTER CLEANER

Maxima Air Filter Cleaner is a purpose specific spray-on air filter cleaner. For use on motorcycles and ATVs. An excellent foam and fabric air filter cleaner that washes out with water. Highly effective emulsion formula contains no caustic chemicals. Removes heavy filter oils, grease and other contaminants. Rated #1 by Dirt Rider magazine as Best Overall Air Filter Cleaner!

- Grease & oil removal
- Breaks down dirt
- Cleans both foam and fabric filter elements
- Easily washes out with water

**May cause some painted surfaces to discolor! Do Not use on plastic or Lexan® windshields! Flammable!**



| DESCRIPTION       | QTY/CS | PART # |       |   |
|-------------------|--------|--------|-------|---|
| 20 oz Aerosol Can | 12     | 930052 | 9.95  | G |
| 64 oz Bottle      | 6      | 930076 | 19.95 | G |



### FAB-1 SPRAY ON FILTER TREATMENT

Advanced spray-on synthetic filter treatment provides unequalled protection against dirt and fine dust. Does not restrict airflow and won't migrate off air filters. Provides long lasting protection for fabric and foam air filters. Sold per can.



| DESCRIPTION       | QTY/CS | PART # |      |   |
|-------------------|--------|--------|------|---|
| 20 oz Aerosol Can | 12     | 930047 | 8.50 | G |



### SPEED WAX

PROFESSIONAL FORMULA Speed Wax is a specialized detailer. An all-in-one detailer that conditions, shines and protects painted surfaces, chrome, anodizing, windscreens and plastic. Advanced formula blends conditioners with color enhancers to produce a brilliant shine. Easy application and removal – Speed Wax is designed to minimize effort and maximize shine and is the quickest way to detail your ride. Soothing wax sets up quickly and easily wipes from smooth surfaces. A single application is all it takes.



| DESCRIPTION         | QTY/CS | PART # |       |   |
|---------------------|--------|--------|-------|---|
| 15.5 oz Aerosol Can | 12     | 930077 | 10.50 | G |



- accessories
- towables
- body
- controls
- electrical
- driveline
- engine
- fuel & intake
- chemicals
- tie downs
- tools
- towing & loading

MARINE



## MAXIMA

### SC 1 SILICONE DETAILER

Restore that factory shine! This superior detailer, polish and light lubricant is specifically formulated for the Powersports industry. SC1 cleans, polishes and conditions plastic, fiberglass and painted surfaces. Makes the cleanup process easier – Excellent for use as an undercoat on motorcycle fenders to prevent mud and dirt from adhering to plastic. SC1 is also effective as a light lubricant for cables and levers. SC1 repels water and dries completely, leaving a long-lasting luster without attracting dirt and dust. Sold per can



| DESCRIPTION       | QTY/CS | PART # |       |   |  |
|-------------------|--------|--------|-------|---|--|
| 12 oz Aerosol Can | 12     | 930062 | 10.50 | G |  |



### AIR FILTER CARE COMBO KIT

2 Pack Contains: Maxima Air Filter Cleaner 15.5oz and Fab1 Spray-on Air Filter Oil 13oz. A clean and perfectly oiled air filter provides maximum airflow and increased horsepower. For use on motorcycles and ATV's. Maxima Air Filter Cleaner is a heavy-duty emulsion-type cleaner designed to thoroughly clean both foam and fabric air filters without damaging foam cells, paper or glue. Maxima Air Filter Cleaner will remove oil and dirt from air filter elements and easily washes out with water. Rated #1 by Dirt Rider magazine. FAB1 spray-on synthetic air filter oil (same proven formula as FFT) provides unequalled protection against the elements. Fab1's time proven formula will not plug foam cells or migrate off of filters. Fab1's protective coating catches dirt and fine dust without restricting airflow. May be used on foam and fabric filters. Water-resistant. This 2 pack is the ultimate air filter cleaner and oil combo kit on the market!



| DESCRIPTION         | QTY/CS | PART # |       |   |  |
|---------------------|--------|--------|-------|---|--|
| 2 Pack Aerosol Cans | 6      | 930125 | 17.95 | G |  |

### CONTACT CLEANER

Heavy duty citrus scented aerosol cleaner is a blend of special cleaning agents that remove grease, oil and other contaminants. Extra heavy propellant charge provides maximum spray pressure for hard to reach areas. Outstanding for use on all engine and suspension parts, carburetors, brakes, spark plugs and much more. Sold per can.



| DESCRIPTION       | QTY/CS | PART # |      |   |  |
|-------------------|--------|--------|------|---|--|
| 13 oz Aerosol Can | 12     | 930051 | 6.95 | G |  |



### MPPL PENETRANT LUBE

Superior, all-purpose spray-on penetrating lubricant displaces moisture while providing excellent rust and corrosion protection. MPPL forms a protective film on metal and will not harm plastic or painted surfaces. Sold per can.



| DESCRIPTION       | QTY/CS | PART # |      |   |  |
|-------------------|--------|--------|------|---|--|
| 20 oz Aerosol Can | 12     | 930054 | 8.95 | G |  |

### BIO WASH

- This product is a unique, biodegradable all-purpose cleaner.
- Special cleaning agents lift away dirt while scrubbing grime & oil based deposits.
- Tough on dirt, yet BIO Wash is gentle enough to use on most surfaces including painted, plastic, chrome, anodizing, rubber, carbon fiber, brake pads or almost anything. Safely & easily clean your equipment.
- Advanced micro chemistry protects aluminum, magnesium & other alloys.
- Eco friendly formula is user friendly & cleanly washes from the surface.
- Alkaline based.
- 50 State VOC compliant.
- Gentle enough for everyday use.

| DESCRIPTION  | QTY/CS | PART # |      |   |  |
|--------------|--------|--------|------|---|--|
| 32 oz Bottle | 12     | 930071 | 8.95 | G |  |



### QUICK 2 MIX BOTTLE

Handy oil ratio bottle that allows you to pick the gallons (or liters), of fuel you are going to mix and then pick the oil ratio (or percentage), and fill the oil to the proper line. Lid keeps dust out of the bottle. Tough polypropylene bottle has ounce, and cc, (milliliter), graduation markings.



| DESCRIPTION  | QTY/CS | PART # |      |   |  |
|--------------|--------|--------|------|---|--|
| 20 oz Bottle | 20     | 930070 | 4.95 | G |  |

accessories  
towables  
body  
controls  
electrical  
driveline  
engine  
fuel & intake  
chemicals  
tie downs  
tools  
towing & loading

MARINE



## MAXIMA



### WATERPROOF GREASE

Multi-purpose grease has excellent resistance to water wash-out and it clings to metal surfaces under the most severe conditions. For use on motorcycle, ATV, personal watercraft and snowmobile components. Provides excellent protection against high loads, extreme temperatures, moisture, rust and corrosion. Sold per jar.

| DESCRIPTION | QTY/CS | PART # |      |   |
|-------------|--------|--------|------|---|
| 16 oz Jar   | 12     | 930057 | 8.95 | G |



### 5-GALLON PAIL PUMP

The economical plastic pump fits on all Maxima 5-gallon pails and 55-gallon drums.

| DESCRIPTION  | QTY/CS | PART # |       |   |
|--------------|--------|--------|-------|---|
| Plastic Pump | N/A    | 930128 | 84.99 | G |



PUMP ONLY



### 2 SHELF COUNTER DISPLAY

Get organized and realize increased sales with this convenient 2 shelf P.O.P. counter model Maxima display. Help keep your Maxima product moving out the door.

| DESCRIPTION             | QTY/CS | PART # |       |   |
|-------------------------|--------|--------|-------|---|
| 2 Shelf Counter Display | N/A    | 930128 | 84.99 | G |

### 5 SHELF METAL FLOOR DISPLAY

Get organized and realize increased sales with this heavy-duty 5 shelf floor rack Maxima display. Help keep your Maxima product moving out the door.

| DESCRIPTION                 | QTY/CS | PART # |        |   |
|-----------------------------|--------|--------|--------|---|
| 5 Shelf Metal Floor Display | N/A    | 930129 | 439.99 | G |



### 5 TIER FLOOR RACK

Newly designed metal display features:

- 5 tiers of selling space (enough display area for qty. 150 1-liter bottles)
- Larger trays
- Full color header and side graphics
- Jet black paint
- Locking caster wheels
- UPS shippable

| DESCRIPTION       | QTY/CS | PART # |        |   |
|-------------------|--------|--------|--------|---|
| 5 Tier Floor Rack | N/A    | 930200 | 199.95 | G |



- accessories
- towables
- body
- controls
- electrical
- driveline
- engine
- fuel & intake
- chemicals
- tie downs
- tools
- towing & loading

MARINE



## KLOTZ

### 2 CYCLE SUPER TECHNIPLATE RACING OIL

- Pure synthetic bases are blended with 20% BeNOL® Racing Castor Oil
- Provides engines the Clean Burn™ quality of Klotz® synthetic lubricants along with the exceptional film strength of castor oil
- Degummed castor oil reduces ring groove deposits and protects engines in high RPM and extreme heat applications
- Blends with methanol alcohol and gasoline



| DESCRIPTION | QTY/CS | PART # | MFG #  |       |   |
|-------------|--------|--------|--------|-------|---|
| 1 Quart     | 10     | KL10   | KL-100 | 12.95 | B |
| 1 Gallon    | 4      | KL101  | KL-101 | 51.95 | B |



### R 50® TECHNIPLATE®

R 50® synthetic lubricant was developed exclusively for use in Hi-RPM racing engines. TechniPlate® R 50® racing lubricity system protects engines from extreme heat and virtually eliminates engine wear. R 50® film strength is comparable to castor oil, but has the benefits of Clean Burn™ technology. Not alcohol compatible. Sold per bottle.

| DESCRIPTION | QTY/CS | PART # | MFG #  |       |   |
|-------------|--------|--------|--------|-------|---|
| 1 Pint      | 10     | KL102  | KL-102 | 8.95  | D |
| 1 Quart     | 10     | 404023 | KL-104 | 14.95 | B |
| 1 Gallon    | 4      | 404024 | KL-105 | 58.95 | B |

### KLOTZ BENOL® 2 CYCLE OIL

BeNOL®, the ultimate in 2-stroke lubricant when it comes to both protection and performance, is the choice of serious racers. Degummed and extra fortified for maximum reliability. BeNOL® provides twice the level of film strength and load carrying capacity of conventional castor oils. Blends with methanol alcohol and gasoline.



| DESCRIPTION | QTY/CS | PART # | MFG #  |       |   |
|-------------|--------|--------|--------|-------|---|
| 1 Gallon    | 4      | BC171  | BC-171 | 63.95 | B |
| 1 Quart     | 10     | BC172  | BC-172 | 13.95 | B |
| 1 Pint      | 10     | BC175  | BC-175 | 8.50  | D |

### KLOTZ UPLON® FUEL LUBE

- Klotz® Uplon® Fuel Lube provides upper cylinder and fuel pump lubrication
- Protects the induction and fuel delivery systems from the dry, abrasive properties of methanol alcohol
- Uplon® Fuel Lube increases horsepower by reducing power robbing friction
- Our unique seal conditioners help maintain constant fuel pressure and prevent lean-out conditions
- Blends with methanol alcohol and gasoline

| DESCRIPTION | QTY/CS | PART # | MFG #  |       |   |
|-------------|--------|--------|--------|-------|---|
| 1 Quart     | 10     | KL107  | KL-107 | 14.95 | B |

### KLOTZ OCTANE BOOSTER

- Klotz® Octane Booster is a concentrated tetraethyl lead substitute formulated to increase the octane rating of gasoline up to 10 numbers or more
- Helps eliminate engine damaging detonation, spark knock, pre-ignition, and pinging from low octane gasoline
- Modifies the burn speed and flash point of gasoline to create a stable combustion chamber flame front, maximizing performance and power
- Stabilizes oxygenated gasoline to prevent leak-out conditions
- Provides needed upper-cylinder lubrication that is missing in unleaded gasoline
- Not alcohol compatible

| DESCRIPTION | QTY/CS | PART # | MFG #  |       |   |
|-------------|--------|--------|--------|-------|---|
| 16 oz       | 10     | KL62   | KL-602 | 10.95 | B |
| 1 Gallon    | N/A    | KL628  | KL-628 | 57.95 | B |



accessories  
towables  
body  
controls  
electrical  
driveline  
engine  
fuel & intake  
chemicals  
tie downs  
tools  
towing & loading

MARINE



## KLOTZ

### KLOTZ NITRO RACING ADDITIVE

- A custom blended nitro additive developed for gas or alcohol
- Dyno tests report a power increase of up to 15%
- Contains Koolinal, a guarding agent to reduce heat and pre-ignition

| DESCRIPTION | QTY/CS | PART #       | MFG #  |              |   |
|-------------|--------|--------------|--------|--------------|---|
| 16 oz       | 10     | <b>KL60</b>  | KL-600 | <b>12.95</b> | B |
| 1 Gallon    | N/A    | <b>KL640</b> | KL-640 | <b>65.95</b> | B |



- accessories
- towables
- body
- controls
- electrical
- driveline
- engine
- fuel & intake
- chemicals**
- tie downs
- tools
- towing & loading



### KLOTZ CONTACT CLEANER

- Contact cleaner and degreaser, shop size aerosol can
- Sprays upside down or right side up
- Cleans electrical systems
- Cleans fouled spark plugs
- Fast degreaser

| DESCRIPTION | QTY/CS | PART #      | MFG #  |             |   |
|-------------|--------|-------------|--------|-------------|---|
| 12.5 oz     | 10     | <b>KL69</b> | KL-609 | <b>9.95</b> | B |

### ASSEMBLY LUBE

- TechniPlate Synthetic Assembly Lube provides needed lubrication during the critical first moments an engine runs
- Coats engine components with a protection film to prevent molecular shearing and metal-to-metal contact
- Rust inhibitors protect machined parts during storage

| DESCRIPTION | QTY/CS | PART #       | MFG #  |             |   |
|-------------|--------|--------------|--------|-------------|---|
| 1 Quart     | 10     | <b>KL311</b> | KL-311 | <b>8.95</b> | B |



### FABRIC FILTER OIL

- Improves air flow
- Filters out micron sized particles
- Traps dust, dirt and sand
- Quickly penetrates and will not run off
- Moisture resistant formula
- Easy application
- Environmentally safe formula

| DESCRIPTION | QTY/CS | PART #       | MFG #  |             |   |
|-------------|--------|--------------|--------|-------------|---|
| 15.25 oz    | 10     | <b>KL607</b> | KL-607 | <b>8.50</b> | B |

### FILTER CLEANER

- Improves air flow and performance
- Cleans fabric and foam air filters
- Cleans oil, dust, dirt and sand from filters
- Rinses clean with water
- Environmentally safe formula

| DESCRIPTION | QTY/CS | PART #       | MFG #  |             |   |
|-------------|--------|--------------|--------|-------------|---|
| 15.25 oz    | 10     | <b>KL608</b> | KL-608 | <b>7.95</b> | B |



# MARINE

- accessories
- towables
- body
- controls
- electrical
- driveline
- engine
- fuel & intake
- chemicals
- tie downs
- tools
- towing & loading



## KLOTZ



### SKICRAFT® X4 TECHNIPLATE® 10W/40

Klotz® SkiCraftX4® 10W/40 is designed for use in the new generation of 4-stroke performance Personal Watercraft engines. Use of this lubricant provides certified warranty compliance and protection. Exceeds manufacturers warranty requirements. TechniPlate® technology is an advanced synthetic lubricity system which contains precision engineered lubricating molecules that protect engine components from molecular shearing and extreme heat. SkiCraftX4® is specially formulated for thermal stability and reduced friction, providing Less Drag...More Power®.

| DESCRIPTION | QTY/CS | PART # | MFG #  |       |   |
|-------------|--------|--------|--------|-------|---|
| 1 Quart     | 10     | 404016 | KL-810 | 11.95 | B |

### JET PUMP LUBRICANT

Klotz® Jet Pump Lubricant exceeds manufacturers' warranty requirements for jet pump lubrication. Jet Pump contains TechniPlate® Synthetic Lubricity Systems to protect against expensive jet pump failures. Jet Pump is compatible with OEM oils.



| DESCRIPTION | QTY/CS | PART # | MFG #  |      |   |
|-------------|--------|--------|--------|------|---|
| 4 oz        | 20     | 404017 | KL-511 | 6.95 | B |

### OUTBOARD TECHNIPLATE® TC-W3

Premium, pure synthetic lubricant. Extremely high load carrying capacity for performance and racing outboards. Clean Burn™, No-Smoke Technology eliminates carbon and residue build-up. Provides fast, easy starting. Use of this lubricant provides certified warranty compliance and optimum protection. Exceeds NMMA TC-W3, JASO FD and ISO-EGD specifications for certified warranty compliance. Not alcohol compatible.



| DESCRIPTION | QTY/CS | PART # | MFG #  |       |   |
|-------------|--------|--------|--------|-------|---|
| 1 Quart     | 10     | 404018 | KL-332 | 11.95 | B |
| 1 Gallon    | 4      | 404019 | KL-333 | 46.95 | B |

### SKICRAFT® TECHNIPLATE® TC-W3

Pure synthetic lubricant. Extremely high load carrying capacity for reduced engine wear. Clean Burn™, No-Smoke Technology eliminates carbon and residue build-up. Use of this lubricant provides certified warranty compliance and protection. Exceeds JASO FD, ISO-EGD, TC-W3, TC-W2, TC-W and API TC low ash specifications for certified warranty compliance. Not alcohol compatible.

| DESCRIPTION | QTY/CS | PART # | MFG #  |       |   |
|-------------|--------|--------|--------|-------|---|
| 1 Quart     | 10     | 404020 | KL-306 | 13.95 | B |
| 1 Gallon    | 4      | 404021 | KL-307 | 50.95 | B |



### 50:1 TECHNIPLATE® TC-W3

2-stroke, pure synthetic lubricant. Extremely high load carrying capacity for reduced engine wear. Clean Burn™, No-Smoke Technology eliminates carbon and residue build-up. Exceeds JASO FD, ISO-EGD, TC-W3, TC-W2, TC-W and API TC low ash specifications for certified warranty compliance. Not alcohol compatible.

| DESCRIPTION | QTY/CS | PART # | MFG #  |      |   |
|-------------|--------|--------|--------|------|---|
| 1 Pint      | 10     | 404022 | KL-305 | 7.95 | B |





## BEL-RAY

### MARINE BIODEGRADABLE 2-STROKE ENGINE OIL

Marine Biodegradable 2-Stroke Engine Oil is a full synthetic, solvent-free, 2-stroke engine oil for marine applications that provides superior wear protection with maximum deposit control. It will effectively clean most existing deposits and prevent the formation of new deposits, eliminating ring sticking and carbon build up, and is fortified with superior rust and corrosion additives and anti-scuff agents for maximum protection, performance and component life. Marine Biodegradable 2-Stroke Engine Oil is a rapidly biodegradable product as demonstrated with the ultimate biodegradability test. Marine Biodegradable 2-Stroke Engine Oil is NMMA TC-W3® and European Eco-label registered.



| 1 LITER<br>(12/CASE) | MFG #     | 4 LITER<br>(4/CASE) | MFG #                    |
|----------------------|-----------|---------------------|--------------------------|
| 620176               | 99070-BT1 | 22.95 J             | 620177 99700-BT4 87.95 J |



### MARINE BIODEGRADABLE MULTIPURPOSE LUBRICANT

Marine Biodegradable Multipurpose Lubricant is a rapidly biodegradable, multi-purpose, penetrating lubricant that cleans, lubricates and protects. It contains superior anti-wear additives that provide high film strength and low film thickness to prevent metal-to-metal contact. Marine Biodegradable Multipurpose Lubricant displaces moisture and can be applied to wet surfaces. Marine Biodegradable Multipurpose Lubricant is greater than 60% biodegradable making it the perfect multipurpose lubricant option for recreational and commercial marine users.

| 175 ML<br>(12/CASE) | MFG #       | 400 ML<br>(12/CASE) | MFG #              | 4 LITER<br>(4/CASE) | MFG #                    |
|---------------------|-------------|---------------------|--------------------|---------------------|--------------------------|
| 620178              | 99704-A175W | 10.95 J             | 620179 99704-A400W | 13.95 J             | 620180 99705-BT4 66.95 J |



### MARINE RUST PREVENTATIVE COATING

Marine Rust Preventive Coating is formulated to provide maximum protection against corrosion. In the harsh marine environment, moisture and salt continuously react with metals, causing rust and corrosion. Marine Rust Preventive Coating is an easily applied, durable barrier rust preventive that prevents the corrosive environment from direct contact with marine equipment. When correctly applied it will provide up to two years of protection against rust and corrosion. Marine Rust Preventive Coating is a waxy, dry-to-the-touch compound in an easy-to-use solvent carrier that can be applied by dipping, spraying or painting. A thin film of Marine Rust Preventive Coating will fully protect the part from rust when stored in an adverse environment, and will afford protection from the effects of handling.

| 4 LITER<br>(4/CASE) | MFG #             |
|---------------------|-------------------|
| 620181              | 99706-BT4 74.95 J |



- accessories
- towables
- body
- controls
- electrical
- driveline
- engine
- fuel & intake
- chemicals
- tie downs
- tools
- towing & loading

# MARINE

## BEL-RAY



### MARINE SILICONE LUBRICANT

Marine Silicone Lubricant is a non-toxic, high viscosity, silicone fluid that is pearlescent in color, smooth, tacky and waterproof. It fights corrosion and lubricates wood, nylon, rubber, metals, canvas and leather. Marine Silicone Lubricant eliminates squeaking and binding.

| 175 ML<br>(12/CASE) | MFG #       | 400 ML<br>(12/CASE) | MFG #       |
|---------------------|-------------|---------------------|-------------|
| 620182              | 99707-A175W | 620183              | 99707-A400W |
| 7.95                | J           | 8.95                | J           |



### MARINE WATERPROOF GREASE

Marine Waterproof Grease is a mineral oil based, aluminum complex grease. Because it is an aluminum complex grease, Marine Waterproof Grease exhibits all of the beneficial properties of that thickener, including being virtually waterproof. It is a severe duty grease providing maximum protection against wear, rust, corrosion and water washout. Marine Waterproof Grease is formulated to provide for wet-duty performance including the wheel bearings of boat trailers in fresh or salt water. Marine Waterproof Grease repels water and is an excellent seal for bushings, bearings, all chassis lubrication points.

| 14 OZ<br>(12/CASE) | MFG #    | 3 OZ<br>(24/CASE) | MFG #       |
|--------------------|----------|-------------------|-------------|
| 620184             | 99710-CG | 620185            | 99710-CG3OZ |
| 10.95              | J        | 4.95              | J           |



### MARINE RACING 2-STROKE ENGINE OIL

Marine Racing 2-Stroke Engine Oil is a premium petroleum-based, ashless, 2-stroke engine oil for marine applications. It provides superior wear protection while allowing for maximum output of engine power. Marine Racing 2-Stroke Engine Oil prevents scuffing, ring sticking and carbon buildup, and provides superior rust and corrosion protection. It meets and exceeds the NMMA TC-W3® requirements. Recommended for use where API TC, JASO FD and ISO E-L-EGD requirements are specified.

| 1 LITER<br>(12/CASE) | MFG #     | 4 LITER<br>(4/CASE) | MFG #     |
|----------------------|-----------|---------------------|-----------|
| 620186               | 99720-BT1 | 620187              | 99720-BT4 |
| 15.95                | J         | 60.95               | J         |

- accessories
- towables
- body
- controls
- electrical
- driveline
- engine
- fuel & intake
- chemicals
- tie downs
- tools
- towing & loading

MARINE



## BEL-RAY

### MARINE 4-STROKE MINERAL ENGINE OIL 25W-40

Marine 4-Stroke Mineral Engine Oil 25W-40 is a premium engine oil specially engineered for the harsh operating conditions of the marine environment. It combines the highest quality mineral base fluids with the latest technology in marine 4-stroke additives to provide super protection against wear, rust, corrosion and deposits. Marine 4-Stroke Mineral Engine Oil 25W-40 exceeds the performance requirements of the new "NMMA FC-W Catalyst Compatible®" standard for marine 4-stroke engine oils and is certified to that standard.



| 1 LITER<br>(12/CASE) | MFG #     | 4 LITER<br>(4/CASE) | MFG #                    |
|----------------------|-----------|---------------------|--------------------------|
| 620188               | 99730-BT1 | 9.95 J              | 620189 99730-BT4 31.95 J |



### MARINE MINERAL GEAR OIL

Marine Mineral Gear Oil is a high performance mineral gear oil engineered specifically for marine applications. It utilizes Extreme Pressure and anti-wear additives to provide maximum gear and bearing protection under the severe conditions of high load, high speed and water contamination and is fortified with rust, corrosion, oxidation and foam inhibitors. Marine Mineral Gear Oil maintains maximum Extreme Pressure and anti-wear performance even when contaminated with up to 25% water. Marine Mineral Gear Oil meets or exceeds the requirements of all major marine gear drive OEMs.

| 1 LITER<br>(12/CASE) | MFG #     | 4 LITER<br>(4/CASE) | MFG #                    |
|----------------------|-----------|---------------------|--------------------------|
| 620190               | 99735-BT1 | 10.95 J             | 620191 99735-BT4 39.95 J |

### MARINE SEMI-SYNTHETIC GEAR OIL

Marine Semi-Synthetic Gear Oil is a high performance, synthetic blend, gear oil engineered specifically for marine applications. It is formulated utilizing the most advanced Extreme Pressure additives, delivering superior protection for high torque/high horsepower marine engines. Marine Semi-Synthetic Gear Oil is GL-5 rated to provide maximum protection under Extreme Pressure and exceeds the requirements of all major OEM marine engine manufacturers. It has been formulated without hazardous chemicals, like Antimony, that could harm the marine environment, making Marine Semi-Synthetic Gear Oil safer to handle and easy to dispose of after use.

| 1 LITER<br>(12/CASE) | MFG #     | 4 LITER<br>(4/CASE) | MFG #                    |
|----------------------|-----------|---------------------|--------------------------|
| 620192               | 99740-BT1 | 11.95 J             | 620193 99740-BT4 44.95 J |



- accessories
- towables
- body
- controls
- electrical
- driveline
- engine
- fuel & intake
- chemicals**
- tie downs
- tools
- towing & loading

MARINE

- accessories
- towables
- body
- controls
- electrical
- driveline
- engine
- fuel & intake
- chemicals
- tie downs
- tools
- towing & loading

MARINE



## BEL-RAY



### MARINE SYNTHETIC GEAR OIL

Marine Synthetic Gear Oil is a high performance, environmentally safe, full synthetic gear oil engineered specifically for marine applications. It uses the most advanced Extreme Pressure additives to deliver superior protection for high torque/high horsepower marine engines. Marine Synthetic Gear Oil uses an industry first Antimony-free formula for an eco-friendly solution to your gear oil needs. It is GL-5 performance rated and exceeds the requirements of all major OEM engine manufacturers.

| 1 LITER<br>(12/CASE) | MFG #     | 4 LITER<br>(4/CASE) | MFG #     |
|----------------------|-----------|---------------------|-----------|
| 620194               | 99741-BT1 | 620195              | 99741-BT4 |
| 17.95                | J         | 66.95               | J         |



### MARINE 4-STROKE SEMI-SYNTHETIC ENGINE OIL

Marine 4-Stroke Semi-Synthetic Engine Oil is a premium semi-synthetic marine engine oil specifically engineered for the harsh operating conditions of the marine environment. Marine 4-Stroke Semi-Synthetic Engine Oil utilizes the highest quality synthetic and mineral base fluids with the latest technology of marine 4-stroke additives to provide superior protection against wear, rust, corrosion and deposits. Marine 4-Stroke Semi-Synthetic Engine Oil is NMMA FC-W

| WEIGHT | 1 LITER<br>(12/CASE) | MFG #     | 4 LITER<br>(4/CASE) | MFG #     |
|--------|----------------------|-----------|---------------------|-----------|
| 10W-30 | 620196               | 99750-BT1 | 620197              | 99750-BT4 |
|        | 9.95                 | J         | 37.95               | J         |
| 10W-40 | 620198               | 99751-BT1 | 620199              | 99751-BT4 |
|        | 9.95                 | J         | 35.95               | J         |



### BEL-RAY BRAKE & PARTS CLEANER

Bel-Ray Brake & Parts Cleaner is a unique low VOC product specifically designed to clean and degrease all metal surfaces. This unique product will clean brake components and remove carbon and oil build-up. It dries in seconds leaving no residue. Bel-Ray Brake & Parts Cleaner can be used to clean fouled spark plugs, carburetor parts, gear boxes, and other engine parts, as well as other areas that require a quick-drying spray. Should not be used on painted surfaces or come into repeated or prolonged contact with plastic or rubber materials.

| 400 ML/16 OZ<br>(12/CASE) | MFG #      |
|---------------------------|------------|
| 620029                    | 99080-A400 |
| 7.95                      | J          |



Bel-Ray continues to proudly manufacture all of its products in the United States. These locally-made products by skilled professionals have traveled the globe and beyond. Bel-Ray lubricants have serviced submarines, weathered chilling arctic cold, defied harsh desert dust and heat, raced to championships wins and even traveled to the moon.

Today Bel-Ray operates with the belief, and challenge, instilled by its founder:

- Provide innovative technology that creates superior performance and value for customers
- Meet the needs of an ever-changing global marketplace, every day
- Do it with integrity, quality and consistency, always





## BEL-RAY

### BEL-RAY EXS SYNTHETIC ESTER 4T ENGINE OIL



60L Kegs and 208L Drums Available  
- Special Order Only - Call For Part Numbers and Pricing

Bel-Ray EXS Synthetic Ester 4T Engine Oil uses the finest quality synthetic hydrocarbon and ester base fluids combined with unique Extreme Pressure, anti-wear additives and shear resistant VI improvers to meet the demands of high-performance applications. Lowers engine temperatures and increases horsepower. Meets the performance requirements of API SM and JASO MA2. Suitable for air-cooled/liquid-cooled 4-stroke engines and wet clutches.

|        | 1 LITER   |            |       | 4 LITER  |        |                  |
|--------|-----------|------------|-------|----------|--------|------------------|
| WEIGHT | (12/CASE) | MFG #      |       | (4/CASE) | MFG #  |                  |
| 10W-40 | 620071    | 99161-B1LW | 20.65 | J        | 620072 | 99161-B4LW 72.00 |
| 15W-50 | 620075    | 99162-B1LW | 20.65 | J        | 620076 | 99162-B4LW 72.00 |
| 10W-50 | 620067    | 99160-B1LW | 17.95 | J        | 620068 | 99160-B4LW 67.95 |
| 5W-40  | 620063    | 99150-B1LW | 17.95 | J        | 620064 | 99150-B4LW 72.00 |

### BEL-RAY H1-R RACING 100% SYNTHETIC ESTER 2T ENGINE OIL

Bel-Ray H1-R Racing 100% Synthetic Ester 2T Engine Oil is the ultimate 2-stroke racing engine oil formulated for all power valve 2-stroke engines. Advanced 100% synthetic ester base oils cling to metal, preventing wear in all 2-stroke applications. Clean burning to prevent carbon build-up in combustion chambers and power valve mechanisms. H1-R keeps engines clean and responsive even under the most severe racing conditions. Not suitable for methanol fuel.

208L Drums Available (Part # 620107)  
- Special Order Only - Call For Pricing



| 379 ML    | 1 LITER     |           | 4 LITER |          |                  |
|-----------|-------------|-----------|---------|----------|------------------|
| (12/CASE) | MFG #       | (12/CASE) | MFG #   | (4/CASE) | MFG #            |
| 620105    | 99280-B379W | 9.70      | J       | 620104   | 99280-B1LW 23.00 |
|           |             |           |         | 620106   | 99280-B4LW 92.00 |



### BEL-RAY MOTO CHILL RACING COOLANT

Bel-Ray® Moto Chill Racing Coolant uses a special non-toxic propylene glycol formula designed for better heat transfer and cooler running engines. Protects from corrosion and extends the life of all motorcycle cooling systems including those using magnesium and aluminum components. The ultimate high-performance engine coolant — especially suited for racing conditions. Do not dilute. Ready to use.

| 1 LITER   | 4 LITER    |          |       |        |                  |
|-----------|------------|----------|-------|--------|------------------|
| (12/CASE) | MFG #      | (4/CASE) | MFG # |        |                  |
| 620143    | 99410-B1LW | 11.55    | J     | 620144 | 99410-B4LW 39.60 |

### BEL-RAY ASSEMBLY LUBE

A high molybdenum disulfide content assembly lubricant which prevents galling and seizing at the highest temperatures and pressures. Clings to all metal surfaces and is ideal for providing start-up lubrication of newly assembled engine parts such as camshaft lobes. Helps prevent thread stripping and allows accurate torquing.

| PART # | DESCRIPTION         | MFG #       |         |
|--------|---------------------|-------------|---------|
| 620019 | 10 OZ BRUSH TOP CAN | 99030-CAB10 | 16.95 J |



### BEL-RAY WATERPROOF GREASE



The legendary high-performance, general purpose grease. Superior water resistance, even in salt water, will ensure continued sealing and protection. Perfect for wheel bearings, headsets, shock linkages, swing arm pivots and other motorcycle, ATV, snowmobile and marine chassis lubrication points. Due to its aluminum complex formula, it won't melt or run out. Enhanced mechanical stability and special anti-wear additives protect and lubricate bearings for improved performance.

| 16 OZ     | 16 OZ CARTRIDGE |           |       |        |                 |
|-----------|-----------------|-----------|-------|--------|-----------------|
| (12/CASE) | MFG #           | (12/CASE) | MFG # |        |                 |
| 620169    | 99540-TB16W     | 9.95      | J     | 620167 | 99540-CF14 8.50 |

- accessories
- towables
- body
- controls
- electrical
- driveline
- engine
- fuel & intake
- chemicals
- tie downs
- tools
- towing & loading

# MARINE



## BEL-RAY

### BEL-RAY FIBER FILTER OIL

Bel-Ray® Fiber Filter Oil was specifically developed for superior performance with all fiber/gauze type air filters. Bel-Ray Fiber Filter Oil is the superior trapping element needed to obtain maximum efficiency from today's fiber/ gauze type air filters. It traps and holds contaminants, will not gum or clog, and does not restrict air flow. Bel-Ray Fiber Filter Oil is water resistant and will not run off.



| 400 ML/16 OZ<br>(12/CASE) | MFG #       |      |   |
|---------------------------|-------------|------|---|
| 620079                    | 99170-A400W | 8.95 | J |

### BEL-RAY 6 IN 1

Bel-Ray 6 in 1 contains anti-wear additives that provide high film strength to this exceptional penetrating and lubricating fluid. Bel-Ray 6 in 1 cleans as it lubricates, protects against rust and corrosion, displaces water, and reduces friction. Bel-Ray 6 in 1 will not harm electrical contacts, vinyl, wood or paint.

| 175 ML<br>(12/CASE) | MFG #       |      |   | 400 ML<br>(12/CASE) | MFG #       |      |   |
|---------------------|-------------|------|---|---------------------|-------------|------|---|
| 620017              | 99020-A175W | 5.80 | J | 620018              | 99020-A400W | 7.95 | J |



## BEL-RAY

### 'FLEX YOUR ENGINE' RACK

Metal display features:

- High quality, long-lasting construction
- Heavy-duty wheels for easy mobility
- Low square footage display (71"H, 27"W, 19"D)
- Aggressive, "Flex Your Engine" Design matches mainstream media campaign for customer awareness
- Limited quantities available

| PART # | MFG #      |        |   |
|--------|------------|--------|---|
| 620000 | 90881-EACH | 528.75 | J |



### BEL-RAY COUNTER RACK

- High quality, long-lasting construction
- Rotating base for 360 (degree sign) access
- Low square footage display (16" H, 15" W, 14 3/4" D)
- Aggressive, "Flex Your Engine" design matches mainstream media campaign for customer awareness
- Limited quantities available

| PART # | MFG #           |       |   |
|--------|-----------------|-------|---|
| 920176 | MCOUNTER-BOXBR5 | 40.00 | G |



- accessories
- towables
- body
- controls
- electrical
- driveline
- engine
- fuel & intake
- chemicals
- tie downs
- tools
- towing & loading



## IPONE

### IPONE GREASE R HIGH-TECH GREASE SPRAY

- High tech aluminum based grease for rust and friction protection
- Recommended for off-road motorcycle chains
- Resistant to pressure, water and salted atmosphere
- Heat resistant up to 800° C.
- Recommended for parts and axles under high pressure
- Ideal for bearing, axle and chain



| DESCRIPTION | QTY/CS | PART # | MFG # |       |   |
|-------------|--------|--------|-------|-------|---|
| 500 ML      | 12     | 46-558 | 558   | 12.95 | A |

### IPONE CARBURETOR CLEANER

- Helps in the maintenance and improvement of a carburetor's performance
- Ideal for cleaning carburetors that were stored for a long time
- Helps clean internal circuits, jets, floats, etc.
- Spray directly into the air inlet, engine running or not



| DESCRIPTION | QTY/CS | PART # | MFG # |       |   |
|-------------|--------|--------|-------|-------|---|
| 750 ML      | 12     | 46-755 | 755   | 13.95 | A |

### IPONE RENOVATOR PLASTIC AND RUBBER PROTECTANT

- Protects and rejuvenates plastic & rubber components on your bike
- Leaves a protective film, which resists fading and cracking due to ultra-violet rays, salt and humidity
- Anti-static film does not attract dust and protects against friction
- Applying spray after washing the Renovator will bring back your ATVs original shine and luster



| DESCRIPTION | QTY/CS | PART # | MFG # |       |   |
|-------------|--------|--------|-------|-------|---|
| 750 ML      | 12     | 46-740 | 740   | 15.95 | A |

### IPONE PROTECTOR 3 MULTI-PURPOSE LUBRICANT

- 3 in 1 product: insulates, prevents rust and leaves a waterproof seal which helps clean your bike
- Protects electrical wires and smoothes cables and threads



| DESCRIPTION | QTY/CS | PART # | MFG # |       |   |
|-------------|--------|--------|-------|-------|---|
| 400 ML      | 24     | 46-732 | 732-D | 10.95 | A |
| 750 ML      | 12     | 46-730 | 430   | 13.95 | A |

### IPONE CLEAN R POLISH NEW FORMULA SPRAY

- Thanks to its double cleaning and brightening action, this gel cleaner is ideal to degrease, clean and polish all surfaces (metal, plastic, polycarbonate)
- High end product



| DESCRIPTION | QTY/CS | PART # | MFG # |       |   |
|-------------|--------|--------|-------|-------|---|
| 750 ML      | 12     | 46-756 | 756   | 12.95 | A |

### IPONE MOTO-WASH SPRAY & REFILL

- Specially designed for motorcycles, not aggressive on aluminum parts
- Dissolves all dirt and grease without deposits
- Just spray, wait 2 minutes and rinse

| DESCRIPTION | QTY/CS | PART # | MFG # |       |   |
|-------------|--------|--------|-------|-------|---|
| 2 x 500 ML  | 12     | 46-768 | 768   | 29.95 | A |

- accessories
- towables
- body
- controls
- electrical
- driveline
- engine
- fuel & intake
- chemicals
- tie downs
- tools
- towing & loading

# MARINE



## PJ1 CHEMICALS ENGINE & TRANSMISSION LUBRICATION

### PJ1 GOLDFIRE® SYNTHETIC BLEND MOTOR OIL 4T

Racing Grade Motor Oil

Attributes:

- High performance semi-synthetic blend
- Single or multi cylinder applications
- Formulated with anti-shearing agents and friction modifiers for wet clutch applications.
- Meets or exceeds API SG and JASO MA
- Good for motors with wet or dry clutches.

| DESCRIPTION      | QTY/CS | PART # | MFG #   |       |   |
|------------------|--------|--------|---------|-------|---|
| 10W-40, 1 Liter  | 6      | 909004 | 9-32    | 14.69 | L |
| 10W-40, 1 Gallon | 2      | 909005 | 9-32-1G | 55.29 | L |
| 20W-50, 1 Liter  | 6      | 909006 | 9-50    | 16.49 | L |
| 20W-50, 1 Gallon | 2      | 909007 | 9-50-1G | 54.89 | L |



### PJ1 SILVERFIRE™ PREMIUM MOTOR OIL 4T

Premium Recreation Grade Motor Oil

Attributes:

- Meets or exceeds API SG, JASO MA
- Low coefficient of friction increases power and engine efficiency
- Shear stable viscosity improver protects against viscosity breakdown
- Keeps engine clean and protects against varnish and sludge formation
- Offers professional level protection at a competitive price level
- Multi-grades provides full protection in all climates and conditions

| DESCRIPTION      | QTY/CS | PART # | MFG #       |       |   |
|------------------|--------|--------|-------------|-------|---|
| 10W-40, 1 Liter  | 6      | 909008 | 9-32-PET    | 13.98 | L |
| 10W-40, 1 Gallon | 2      | 909009 | 9-32-1G-PET | 46.99 | L |
| 20W-50, 1 Liter  | 6      | 909010 | 9-50-PET    | 15.69 | L |
| 20W-50, 1 Gallon | 2      | 909011 | 9-50-1G-PET | 52.99 | L |



### PJ1 GOLDFIRE® PRO PREMIX OIL 2T

Our Best Two-Stroke Oil

Attributes:

- Formulated for very high RPM conditions
- Minimizes engine wear
- Extraordinarily clean burning
- Keeps reed valves free of residue and operating at their peak performance
- Originally developed in conjunction with Kenny Roberts' Grand Prix road race team under race conditions
- Can be mixed up to 50:1
- Racing grade synthetic pre-mix

| DESCRIPTION | QTY/CS | PART # | MFG #   |       |   |
|-------------|--------|--------|---------|-------|---|
| 1/2 Liter   | 6      | 909012 | 8-16    | 12.93 | L |
| 1 Liter     | 6      | 909013 | 8-16-1L | 23.19 | L |
| 1 Gallon    | 2      | 909014 | 8-16-1G | 94.03 | L |



### PJ1 SILVERFIRE™ PREMIX OIL 2T SYNTHETIC BLEND

Semi-Synthetic Two-Stroke Pre Mix Oil

Attributes:

- Competition grade semi-synthetic blend
- Great for sport riding
- Keeps reed valves free of residue and operating at their peak performance
- Offers professional level protection at a competitive price

| DESCRIPTION | QTY/CS | PART # | MFG #   |       |   |
|-------------|--------|--------|---------|-------|---|
| 1 Liter     | 6      | 909015 | 6-32-1L | 17.23 | L |



### PJ1 SILVERFIRE™ INJECTOR OIL 2T SYNTHETIC BLEND

Synthetic Blend Two-Stroke Injector Oil

Attributes:

- Specially formulated for injector applications
- Performance semi-synthetic blend
- Great for competitive use
- Offers professional level protection at an amateur level price

| DESCRIPTION | QTY/CS | PART # | MFG # |       |   |
|-------------|--------|--------|-------|-------|---|
| 1 Liter     | 6      | 909016 | 7-32  | 17.23 | L |



accessories  
towables  
body  
controls  
electrical  
driveline  
engine  
fuel & intake  
chemicals  
tie downs  
tools  
towing & loading

MARINE



## PJ1 CHEMICALS FUEL SYSTEM ADDITIVES

### PJ1 FUEL INJECTOR & CARB CLEANER



Fuel System Cleaner and Treatment

Attributes:

- Keeps injectors/Carburetors at peak performance for smooth and consistent power
- Removes fuel deposits and petroleum debris
- Safe for all leaded, unleaded and oxygenated fuels
- For 2 and 4 stroke engines



| DESCRIPTION | QTY/CS | PART # | MFG # |       |   |
|-------------|--------|--------|-------|-------|---|
| 12 Fluid oz | 6      | 909038 | 13-12 | 11.19 | L |

### PJ1 OCTANE PLUS®

Octane Booster and Fuel Stabilizer

Attributes:

- Increases fuel octane
- Stabilizes fuel
- Increases horsepower
- Lead substitute for engines requiring leaded fuel
- Reduces "Knock" and "Ping"
- Alleviates dieseling
- Helps prevent gas line freeze-up
- For 2 and 4 stroke engines



| DESCRIPTION | QTY/CS | PART # | MFG # |       |   |
|-------------|--------|--------|-------|-------|---|
| 16 Fluid oz | 6      | 909039 | 13-16 | 14.99 | L |



## PJ1 CHEMICALS AIR FILTRATION OILS & CLEANERS

### PJ1 FABRIC AIR FILTER TREATMENT

Enhances Efficacy of Fabric Filters

Attributes:

- Filters airborne debris to protect your engine
- Easy to use - no waste
- Water proof



| DESCRIPTION | QTY/CS | PART # | MFG # |       |   |
|-------------|--------|--------|-------|-------|---|
| 15 oz       | 6      | 909033 | 4-20  | 12.79 | L |



### PJ1 FILTER CLEANER

Cleans Foam and Fabric Filters

Attributes:

- For foam and Fabric Filters
- Easy to use: Spray on - wash off
- Won't harm glues



| DESCRIPTION | QTY/CS | PART # | MFG # |       |   |
|-------------|--------|--------|-------|-------|---|
| 15 oz       | 6      | 909036 | 15-22 | 13.19 | L |



- accessories
- towables
- body
- controls
- electrical
- driveline
- engine
- fuel & intake
- chemicals
- tie downs
- tools
- towing & loading

# MARINE



## PJ1 CHEMICALS CLEANERS & PROTECTANTS



### PJ1 SUPER CLEANER

Multi-Application Non-Residue Degreaser

Attributes:

- High pressure blasts
- Powerful solvents melts grease and grime away
- Dries quickly
- Leaves no residue

| DESCRIPTION | QTY/CS | PART # | MFG # |       |   |
|-------------|--------|--------|-------|-------|---|
| 13 oz       | 6      | 909041 | 3-21  | 11.29 | L |



### PJ1 SPRAY & WASH

Aggressive Degreaser and Cleaner

Attributes:

- Rinses off with water
- Save on plastics
- Leaves no film or residue
- Has pleasant fragrance

| DESCRIPTION | QTY/CS | PART # | MFG #   |       |   |
|-------------|--------|--------|---------|-------|---|
| 13 oz       | 6      | 909043 | 15-20-1 | 10.13 | L |



### PJ1 PROFESSIONAL CARBURETOR AND CHOKE CLEANER

External Carburetor and Throat Cleaner

Attributes:

- Powerful Spray
- Quickly cleans and frees valve, injector jets, and linkages
- Not harmful to rubber, vinyl or neoprene

| DESCRIPTION | QTY/CS | PART # | MFG # |       |   |
|-------------|--------|--------|-------|-------|---|
| 16 oz       | 6      | 909044 | 40-1  | 11.29 | L |



### PJ1 PROFESSIONAL BRAKE CLEANER

Professional Power Brake Cleaner

Attributes:

- Powerful spray
- Cleans and degreases contaminants from brake units
- Evaporates quickly and leaves no residue
- Improves braking performance

| DESCRIPTION | QTY/CS | PART # | MFG #  |       |   |
|-------------|--------|--------|--------|-------|---|
| 13 oz       | 6      | 909046 | 40-2-1 | 11.29 | L |

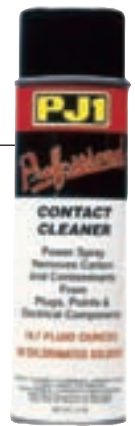

### PJ1 PROFESSIONAL CONTACT CLEANER

Professional Contact Cleaner

Attributes:

- Powerful Spray
- Removes Carbon and contaminants from plugs, points, and electrical components

| DESCRIPTION | QTY/CS | PART # | MFG #  |       |   |
|-------------|--------|--------|--------|-------|---|
| 13 oz       | 6      | 909048 | 40-3-1 | 11.29 | L |



### PJ1 RENEW AND PROTECT®

Non Oily Surface Treatment

Attributes:

- Unique, super silicone formula provides a penetrating moisturizer
- Restores original appearance
- Leaves satin not glossy finish
- For rubber, vinyl, plastic, wood and treated leather.

| DESCRIPTION | QTY/CS | PART # | MFG # |       |   |
|-------------|--------|--------|-------|-------|---|
| 8 Fluid oz  | 12     | 909049 | 23-8  | 14.83 | L |
| 16 Fluid oz | 12     | 909050 | 23-16 | 20.09 | L |

- accessories
- towables
- body
- controls
- electrical
- driveline
- engine
- fuel & intake
- chemicals
- tie downs
- tools
- towing & loading

MARINE



## PJ1 CHEMICALS AEROSOL COATINGS

### PJ1 FAST BLACK 1500° F EXHAUST PAINT

Specifically Designed for Exhaust Systems

Attributes:

- Withstands 2000°F (1093°C)
- Flat finish



| DESCRIPTION | QTY/CS | PART # | MFG #  |       |   |
|-------------|--------|--------|--------|-------|---|
| 11 oz       | 6      | 909051 | 16-HIT | 17.49 | L |

### PJ1 500° F FAST BLACK ENGINE AND CASE PAINT

For Engines and Crank Cases

Attributes:

- Withstands up to 500°F (260°C)



| DESCRIPTION        | QTY/CS | PART # | MFG #  |       |   |
|--------------------|--------|--------|--------|-------|---|
| Gloss Black, 11 oz | 6      | 909052 | 16-ENG | 15.99 | L |
| Black Satin, 11 oz | 6      | 909053 | 16-SAT | 16.49 | L |

### PJ1 FAST BLACK PORCELAIN HARD EPOXY PAINT

Super Tough Epoxy Paint

Attributes:

- Dries to an extremely hard and durable finish
- Gloss black
- 250°F



| DESCRIPTION | QTY/CS | PART # | MFG #  |       |   |
|-------------|--------|--------|--------|-------|---|
| 11 oz       | 6      | 909054 | 16-GLS | 15.99 | L |

### PJ1 WRINKLE BLACK

High Temperature Textured Finish Paint

Attributes:

- Withstands 350°F (177°C)
- Has wrinkle textured finish



| DESCRIPTION | QTY/CS | PART # | MFG #  |       |   |
|-------------|--------|--------|--------|-------|---|
| 11 oz       | 6      | 909055 | 16-WKL | 16.99 | L |

accessories

towables

body

controls

electrical

driveline

engine

fuel & intake

chemicals

tie downs

tools

towing & loading

MARINE



- accessories
- towables
- body
- controls
- electrical
- driveline
- engine
- fuel & intake
- chemicals**
- tie downs
- tools
- towing & loading



## PJ1 CHEMICALS PROFESSIONAL PRODUCTS

### PJ1 CABLE LUBE

Cable Lubricant

Attributes:

- Makes cable controls easier
- Extends cable life
- Cleans and lubricates
- Easy to use



| DESCRIPTION | QTY/CS | PART # | MFG # |       |   |
|-------------|--------|--------|-------|-------|---|
| 11 oz       | 6      | 909057 | 1-12  | 13.19 | L |

### PJ1 LPC-3® PENETRANT/LUBRICANT

Super Rust Busting Penetrating Lubricant

Attributes:

- Aggressively penetrates to increase efficacy
- Multipurpose lubricant
- Super rust buster
- Protects metal



| DESCRIPTION | QTY/CS | PART # | MFG # |       |   |
|-------------|--------|--------|-------|-------|---|
| 11 oz       | 6      | 909058 | 12-11 | 13.49 | L |



### PJ1 FOG BLOCKER

Attributes:

- Prevents lens fogging
- Recommended for helmet shields, goggles, glasses and mirrors

| DESCRIPTION | QTY/CS | PART # | MFG # |       |   |
|-------------|--------|--------|-------|-------|---|
| 4 Fluid oz  | 12     | 909059 | 25-4  | 10.29 | L |

### PJ1 SPRAY ENGINE ASSEMBLY LUBE

Engine Assembly Lube

Attributes:

- Aerosol package for quick, easy application
- Synthetic and petroleum oil soluble
- For crank shafts, valve guides, cylinder walls, pistons, cam shafts, etc.



| DESCRIPTION | QTY/CS | PART # | MFG #  |       |   |
|-------------|--------|--------|--------|-------|---|
| 11 oz       | 6      | 909062 | SP-701 | 16.49 | L |





## K100 FUEL TREATMENT

Run Cleaner, Run Stronger, Run Longer

K100 Fuel Treatments are proprietary formulations of complex engineered organic compounds developed to eliminate water in fuels, remove gums and varnishes and stabilize fuel, add lubricity and corrosion protection and boost cetane/octane ratings. Its ALL- IN ONE Chemistry is all you will need to keep your engines running right.



**K100 Fuel Treatment** are for ALL gasoline and diesel powered equipment and are formulated for use with all fuels including E-10, ULSD, Off-Road, Bio-Diesel and Home-Heating Fuels.



**K100-G**  
Gasoline Fuel Treatment  
for 2 & 4 Cycle Engines



**K100-MG**  
Gasoline Fuel Treatment  
w/Enhanced  
Stabilizer for 2 & 4  
Cycle Engines

| DESC.        | QTY/CS | PART # |       |   |
|--------------|--------|--------|-------|---|
| 8 oz Bottle  | 12     | 965000 | 8.95  | E |
| 32 oz Bottle | 12     | 965001 | 27.95 | E |

| DESC.        | QTY/CS | PART # |       |   |
|--------------|--------|--------|-------|---|
| 8 oz Bottle  | 12     | 965002 | 8.95  | E |
| 32 oz Bottle | 12     | 965003 | 29.95 | E |



**K100-D**  
Diesel Fuel Treatment



**K100-MD**  
Diesel Fuel Treatment w/  
Enhanced Stabilizers

| DESC.        | QTY/CS | PART # |       |   |
|--------------|--------|--------|-------|---|
| 8 oz Bottle  | 12     | 965004 | 8.95  | E |
| 32 oz Bottle | 12     | 965005 | 27.95 | E |

| DESC.        | QTY/CS | PART # |       |   |
|--------------|--------|--------|-------|---|
| 8 oz Bottle  | 12     | 965006 | 8.95  | E |
| 32 oz Bottle | 12     | 965007 | 29.95 | E |

### Benefits of Using K100

- Prevents phase separation in ethanol blended gasoline
- Eliminates water and all water related problems
- Stabilizes fuel for up to two years, and keeps it fresh
- Increases Octane/Cetane ratings 1 1/2 to 2 points
- Replaces lost lubricity in LSD, ULSD and K-1 winter blends
- Reduces black smoke, unburned hydrocarbons, CO and particulate emissions
- Reduces maintenance costs and down time and extends engine life
- Cleans engines and fuel systems for better mileage, easier starts, smoother idle, more power and better acceleration

- accessories
- towables
- body
- controls
- electrical
- driveline
- engine
- fuel & intake
- chemicals
- tie downs
- tools
- towing & loading

MARINE



## GOLD EAGLE

### STA-BIL ETHANOL TREATMENT AND PERFORMANCE IMPROVER

STA-BIL Ethanol Treatment helps remove water, protects against corrosion, and cleans fuel injectors, carburetors, and intake valves to keep the fuel system free of gum and varnish and deposits. Perfect for use in your everyday driving vehicle, such as your car, truck, SUV or mini-van, and also great for your small gasoline powered equipment -- lawn mowers, chain saws, weed wackers, snow blowers, snowmobiles, etc. Recommended to be used at every fill up to keep your vehicle and equipment running smoothly year-round.

- Perfect for use in cars, trucks and small engines!
- Prevents corrosion
- Helps remove water from Fuel
- Cleans fuel injectors, carburetors and intake valves for better, overall performance
- Recommended for use at every fill up

| DESCRIPTION      | QTY/CS | PART # | MFG # |      |   |
|------------------|--------|--------|-------|------|---|
| 10 oz, Sold Each | 24     | 452002 | 22264 | 8.95 | G |



### STA-BIL MARINE FORMULA ETHANOL TREATMENT

With Extra Corrosion Protection & Fuel System Cleaning to help prevent corrosion damage and improve engine performance year-round

- Designed to fight many of the damaging effects of ethanol in gasoline in marine fuel systems (from fuel tanks which vent to the air), and the marine environment (more moisture in the air), which can result in greater problems with: Corrosion - from ethanol-induced water attraction & condensation from temperature changes; Fuel System Deposits - ethanol acts as a solvent on accumulated deposits, causing engine performance problems
- Compared with regular STA-BIL, new MARINE Formula STA-BIL has: - Extra Corrosion Protection: DOUBLE the corrosion preventer – to prevent corrosion damage to fuel tanks, fuel pumps, fuel lines, carburetors and injectors, - Extra Fuel System Cleaning: A COMPLETE fuel system cleaner, with more than 4 TIMES the cleaner – to clean-up power-robbing deposits from fuel lines, carburetors, fuel injectors and intake valves

| DESCRIPTION                              | PART #   | MFG # |       |   |
|--|----------|-------|-------|---|
| Quick Measure 8 oz, Sold Each            | STA22239 | 22239 | 10.95 | G |
| Quick Measure 32 oz, Sold Each           | STA22240 | 22240 | 28.95 | G |
| Counter Display 8 oz, Sold Per Case Of 8 | 452001   | 22253 | 80.95 | G |



### STA-BIL FUEL STABILIZER

- Keeps fuel fresh indefinitely
- Prevents gum and varnish buildup
- Prevents rust and corrosion
- Avoid mess of draining fuel
- Recommended by major engine manufacturers
- For use on all 2-cycle and 4-cycle engines
- 2 oz treats 2 gallons of fuel
- 4 oz treats 5 gallons of fuel
- 8 oz treats 10 gallons of fuel
- 1 qt. treats 80 gallons of fuel



| DESCRIPTION                   | QTY/CS | PART #  | MFG # |       |   |
|-------------------------------|--------|---------|-------|-------|---|
| 4 oz Carded, Sold Each        | 24     | STA1104 | 22204 | 4.95  | G |
| Quick Measure 8 oz, Sold Each | 12     | STA1118 | 22208 | 7.45  | G |
| Quick Measure 1 qt, Sold Each | 12     | STA1132 | 22214 | 17.95 | G |



accessories  
towables  
body  
controls  
electrical  
driveline  
engine  
fuel & intake  
chemicals  
tie downs  
tools  
towing & loading

MARINE



## GOLD EAGLE



### OCTANE BOOST

- Boosts power
- Improves gas mileage
- Cleans fuel injectors and the complete fuel system
- Reduces knocks, pings and hesitation
- Safe for catalytic converters and oxygen sensors



| DESCRIPTION      | QTY/CS | PART #   | MFG # |      |   |
|------------------|--------|----------|-------|------|---|
| 16 oz, Sold Each | 6      | STA10406 | 10406 | 7.35 | G |

### ISO-HEAT WATER REMOVER AND FUEL SYSTEM ANTIFREEZE

- #1 selling Brand of premium gas-line antifreeze
- Absorbs 5 times more water than regular gas-line antifreeze
- Designed for year round use in all 2-cycle and 4-cycle gas & diesel engines
- Removes water from fuel system
- Prevents rust and corrosion

| DESCRIPTION      | QTY/CS | PART #  | MFG # |      |   |
|------------------|--------|---------|-------|------|---|
| 12 oz, Sold Each | 24     | STA5360 | 28202 | 3.45 | G |



### HEET #1 GAS-LINE ANTIFREEZE & WATER REMOVER

- #1 selling Brand of gas-line antifreeze and water remover
- Safe for use in all 4-cycle engines including fuel injected engines
- Prevents gas-line freeze-up
- Removes water from fuel system
- Prevents rust and corrosion

| DESCRIPTION      | QTY/CS | PART #  | MFG # |      |   |
|------------------|--------|---------|-------|------|---|
| 12 oz, Sold Each | 24     | STA5120 | 28201 | 2.45 | G |



### FOGGING OIL

- Double rust inhibitor action - both liquid and vapor phase
- Mono-molecular layer protects internal metal surfaces
- Super atomizing formulation assures 100% coverage
- Also preserves fishing reels, electrical connections and empty fuel tanks
- 12 oz aerosol can

| DESCRIPTION      | QTY/CS | PART #  | MFG # |      |   |
|------------------|--------|---------|-------|------|---|
| 12 oz, Sold Each | 6      | STA1210 | 22001 | 6.15 | G |



### HEAVY DUTY CARB & CHOKE CLEANER

- Quickly cleans and dissolves gum, varnish, dirt, lead and carbon deposits
- Leaves no oily residue
- Aids faster starting and smoother idling
- Helps restore performance and gas mileage
- For all carbureted, internal combustion engines
- Safe for catalytic converters and oxygen sensors
- For cars, trucks, boats, lawn mowers, snowmobiles, motorcycles and snowblowers

| DESCRIPTION        | QTY/CS | PART #  | MFG # |      |   |
|--------------------|--------|---------|-------|------|---|
| 12.5 oz, Sold Each | 12     | STA0015 | GC15  | 4.95 | G |



- accessories
- towables
- body
- controls
- electrical
- driveline
- engine
- fuel & intake
- chemicals
- tie downs
- tools
- towing & loading

MARINE

- accessories
- towables
- body
- controls
- electrical
- driveline
- engine
- fuel & intake
- chemicals
- tie downs
- tools
- towing & loading

MARINE

## STAR BRITE

### “SEF” SMALL ENGINE FORMULA GAS ADDITIVE

- Eliminates and prevents ethanol fuel problems
- Increases fuel economy
- Makes engines start easier, run smoother
- Stabilizers fuel for up to one year
- 1 fl. oz treats 6 gallons of gas
- Reduces all emissions
- Lowers fuel system maintenance
- Eliminates carbon build-up in fuel delivery system and on exhaust components
- Cannot be overdosed

| DESCRIPTION                              | QTY/CS | PART # | MFG # |       |   |
|--|--------|--------|-------|-------|---|
| 1 Fluid oz, Sold Per Pair                | 12     | 904499 | 14301 | 5.99  | H |
| 8 Fluid oz, Sold Each                    | 6      | 904500 | 14308 | 8.49  | H |
| Counter Display 8 oz, Sold Per Case Of 6 | N/A    | 904501 | 14616 | 57.59 | H |



### MARINE ENGINE FORMULA GASOLINE ADDITIVE

- Eliminates and prevents ethanol fuel problems
- Increases fuel economy
- Makes engines start easier, run smoother
- Stabilizers fuel for up to one year
- 1 fl. oz treats 16 gallons of gas
- Reduces all emissions
- Lowers fuel system maintenance
- Eliminates carbon build-up in fuel delivery system and on exhaust components
- Cannot be overdosed

| DESCRIPTION            | QTY/CS | PART # | MFG # |       |   |
|------------------------|--------|--------|-------|-------|---|
| 8 Fluid oz, Sold Each  | 12     | 904502 | 93008 | 14.79 | H |
| 16 Fluid oz, Sold Each | 12     | 904503 | 93016 | 24.49 | H |



### STAR COOL PG ENGINE COOLANT

- Utilizes Star Brite's revolutionary PCT additive package designed to maintain an engine's optimum operating temperature in order to develop maximum horsepower.
- Allows engines to quickly reach and then maintain proper temperature.
- Reduces operating temperatures faster than other coolants.
- Formulated to meet or exceed all OEM and appropriate ASTM specs.
- Does not contain nitrates, amines, phosphates, silicates, borates or other ingredients that can clog radiators.
- Formulated to seal pinhole leaks or fissures.
- Non-toxic propylene glycol formula.
- Can be used in all gasoline or diesel water-cooled engines.
- Ideal for year-round use; Protects against boil over to 265°F (129°C) and freezing down to -26°F (-32°C).

| DESCRIPTION                   | QTY/CS | PART # | MFG # |       |   |
|-------------------------------|--------|--------|-------|-------|---|
| 50/50 1 Gallon, Sold Each     | 4      | 904680 | 33200 | 34.95 | H |
| 50/50 64 Fluid oz., Sold Each | 4      | 904681 | 33264 | 19.95 | H |



## UNI FILTER OIL & FILTER CLEANER

Uni Foam Filter Oil allows a maximum airflow while keeping the dirt and dust particles out. Uni Filter Cleaner's powerful agents quickly strip away grease and dirt, yet won't damage air filters. Just spray it on, let it soak and rinse off. Safe to use on all OEM and performance air filters.

| DESCRIPTION                                   | PART # | MFG #   |       |   |
|---|--------|---------|-------|---|
| 16 oz Cleaner                                 | UFC300 | UFC-300 | 11.95 | L |
| 5.5 oz Oil                                    | UFF100 | UFF-100 | 9.95  | L |
| 16 oz Oil                                     | UFF16  | UFF-16  | 9.95  | L |
| Maintenance Kit, Includes 1 UFC300 & 1 UFF100 | UFM400 | UFM-400 | 19.95 | L |





K&N

## FILTER CHARGER OIL

K&N Air Filter Oil is the only oil specially formulated to work in combination with the cotton fabric in K&N Filtercharger elements providing a superior air filtration system. When used as directed, it quickly penetrates the filter pleats, where it remains suspended in the cotton fabric. Saturation is maintained until the element is cleaned with K&N Air Filter Cleaner.

| DESCRIPTION          | QTY/CS | PART #  | MFG #    |       |   |
|----------------------|--------|---------|----------|-------|---|
| 6-1/2 oz Aerosol Can | 12     | 560504  | 99-0504  | 8.99  | G |
| 12 oz Aerosol Can    | 12     | 560516  | 99-0516  | 10.59 | G |
| 8 oz Squeeze Bottle  | 12     | 560533  | 99-0533  | 6.69  | G |
| 1/2 oz Pillow Pack   | 50     | 5611312 | 99-11312 | 6.89  | G |



## RECHARGER FILTER CARE SERVICE KITS

### AEROSOL

A six-step maintenance system designed to clean any K&N Filtercharger® Air Filter. Restores air flow efficiency so your Filtercharger™ performs like new! Includes: 6.5 oz Spray Oil & 12 oz Filter Cleaner

| DESCRIPTION                             | PART # | MFG #   |       |   |
|---|--------|---------|-------|---|
| 6.5 oz Spray Oil & 12 oz Filter Cleaner | 605653 | 99-5000 | 16.49 | G |



### SQUEEZE BOTTLE

A six-step maintenance system designed to clean any K&N Filtercharger® Air Filter. Restores air flow efficiency so your Filtercharger™ performs like new! Includes: 8 oz Squeeze Oil & 12 oz Filter Cleaner

| DESCRIPTION                             | PART # | MFG #   |       |   |
|---|--------|---------|-------|---|
| 8 oz Squeeze Oil & 12 oz Filter Cleaner | 605654 | 99-5050 | 16.49 | G |

## AIR FILTER CLEANER & DEGREASER

K&N Air Filter Cleaner is the only cleaner formulated to clean K&N Filtercharger elements. K&N Cleaner works to dissolve the dirt build up and old filter oil, and can be washed away with water. It is biodegradable and safe on paint, chrome, cast aluminum, plastic, rubber and vinyl when used as directed. **NOTE: Do not use on polished or anodized aluminum.**

| DESCRIPTION                | QTY/CS | PART # | MFG #   |       |   |
|----------------------------|--------|--------|---------|-------|---|
| 12 Fluid oz Squirrt Bottle | 12     | 560606 | 99-0606 | 9.39  | G |
| 32 Fluid oz Squirrt Bottle | N/A    | 560621 | 99-0621 | 14.89 | G |



## K&N SEALING GREASE

K&N Sealing Grease provides an airtight fit around sealing surfaces on all types of air filter elements. It resists heat and will not melt or run off. K&N sealing grease is not to be used on clamp-on filter elements.

| DESCRIPTION       | QTY/CS | PART # | MFG #   |       |   |
|-------------------|--------|--------|---------|-------|---|
| 6 oz Squeeze Tube | 12     | 560704 | 99-0704 | 13.89 | G |

- accessories
- towables
- body
- controls
- electrical
- driveline
- engine
- fuel & intake
- chemicals
- tie downs
- tools
- towing & loading

MARINE



## LIQUID PERFORMANCE

### LP SPRAY CLEANER & POLISH

Liquid Performance Premium Spray Cleaner & Polish is specially formulated to remove road grime, dirt, grease and bugs on contact. When used as directed this quick detailer with it's spray on, wipe off formula requires no water and leaves a showroom shine that protects against sun damage, ozone damage and dirt accumulation in one easy step. Liquid Performance Spray Cleaner & Polish works great on painted surfaces, chrome, street bikes, watercraft, automobiles and more.

| DESCRIPTION | QTY/CS | PART # | MFG # |      |   |
|-------------|--------|--------|-------|------|---|
| 14 oz       | 12     | 650195 | 0140  | 7.99 | H |
| 5 oz        | 12     | 650193 | 0701  | 5.99 | H |



### LP QUICK DETAILING KIT

The perfect product for in between wash-ings, this kit contains one 14oz can of Liquid Performance Spray Cleaner & Polish and two 16"x16" microfiber detailing cloths. Great for removing bugs and road grime and leaves a deep lasting shine that protects against the elements. These microfiber cloths can be machine washed for continued use.

| DESCRIPTION | QTY/CS | PART # | MFG # |       |   |
|-------------|--------|--------|-------|-------|---|
| Kit         | 6      | 650201 | 0697  | 15.99 | H |



### LP ROADSIDE DETAILING KIT

This smaller kit contains our popular Spray Cleaner & Polish in a 5oz can and one 16"x16" microfiber detailing cloth in a convenient package. Fits easily into motorcycle saddle bags so you can take it along with you on that weekend trip or to the show across town.

| DESCRIPTION | QTY/CS | PART # | MFG # |       |   |
|-------------|--------|--------|-------|-------|---|
| Kit         | N/A    | 650199 | 0696  | 10.99 | H |

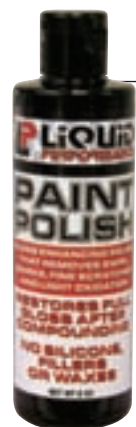

### LP PREMIUM PAINT POLISH

Liquid Performance Premium Paint Polish is a buffered swirl mark reducer and gloss enhancing polish. Great for restoring full gloss after compounding or to remove fine scratches, swirl marks or light oxidation. Apply by hand or machine. Contains no silicone, fillers or waxes and is clearcoat safe.

| DESCRIPTION | QTY/CS | PART # | MFG # |       |   |
|-------------|--------|--------|-------|-------|---|
| 8 oz        | 12     | 650203 | 0769  | 10.99 | H |

### LP STREET BIKE CLEANING & DETAILING KIT

This kit contains all of the products needed to keep your bike looking like new.

- One 32 oz spray bottle of LP Street Bike Wash
- One 14 oz can of LP Spray Cleaner & Polish
- One 8 oz bottle of LP Metal Polish
- Two 16"x16" LP Microfiber Cloths



| DESCRIPTION | QTY/CS | PART # | MFG # |       |   |
|-------------|--------|--------|-------|-------|---|
| Kit         | 4      | 650198 | 0510  | 36.99 | H |

## LIQUID PERFORMANCE



### LP PREMIUM METAL POLISH

Liquid Performance Premium Metal Polish is a thick no-run formula that cleans, polishes and preserves most metal surfaces including: chrome, aluminum, brass, nickel, stainless steel, bronze, copper, magnesium, platinum, and more. This product makes billet shine like chrome. Not recommended for use on anodized or clear coated surfaces.

| DESCRIPTION | QTY/CS | PART # | MFG # |       |   |
|-------------|--------|--------|-------|-------|---|
| 8 oz        | 12     | 650200 | 0478  | 13.99 | H |

### LP PREMIUM POLY-WAX HIGH GLOSS PAINT SEALANT

Liquid Performance Premium Poly-Wax with its polymer based formula provides long lasting protection from dirt, road salts, detergents and oxidation. This easy to use formula delivers a deep, wet-looking high-gloss shine without the hard work and messy white residue of traditional waxing. Liquid Performance Premium Poly-Wax provides months of protection in one easy step!

| DESCRIPTION | QTY/CS | PART # | MFG # |       |   |
|-------------|--------|--------|-------|-------|---|
| 8 oz        | 12     | 650206 | 0770  | 12.99 | H |



### LP ETHANOL EQUALIZER

Liquid Performance Ethanol Equalizer is all you need to fix problems related to ethanol added fuels. Its synthetic blend prevents water build up, fuel system corrosion and ethanol phase separation that robs fuel of octane. Ethanol Equalizer replaces lost octane, increases horse-power, and stabilizes fuel for extended storage. One 4oz bottle treats up to 40 gallons. This product is EPA registered.

| DESCRIPTION | QTY/CS | PART # | MFG # |      |   |
|-------------|--------|--------|-------|------|---|
| 4 oz        | 12     | 650204 | 0765  | 7.99 | H |
| 1 oz        | 24     | 650205 | 0766  | 2.99 | H |

### LP COMPLETE FUEL SYSTEM CLEANER

Liquid Performance Complete Fuel System Cleaner is an advanced combustion chamber detergent which is highly effective for all types of fuel system deposits. It provides superior intake valve deposit control, port fuel injection and carburetor detergency. Liquid Performance Complete Fuel System Cleaner reduces combustion chamber deposits and eliminates the cause of pre-ignition, reduces run-on and rapidly cleans up carburetors, fuel injectors, intake valves and manifolds to restore your vehicles original power, performance and fuel mileage.

| DESCRIPTION | QTY/CS | PART # | MFG # |      |   |
|-------------|--------|--------|-------|------|---|
| 4 oz        | 12     | 650207 | 0767  | 6.99 | H |
| 1 oz        | 24     | 650208 | 0768  | 2.99 | H |



- accessories
- towables
- body
- controls
- electrical
- driveline
- engine
- fuel & intake
- chemicals**
- tie downs
- tools
- towing & loading

MARINE

- accessories
- towables
- body
- controls
- electrical
- driveline
- engine
- fuel & intake
- chemicals**
- tie downs
- tools
- towing & loading



## LIQUID PERFORMANCE

### LP TOPKOTE SILICONE FINISHING SPRAY

Liquid Performance Topkote Finishing Spray is an advanced silicone product that is the perfect finishing touch. This great melon scented spray, quickly treats plastics, vinyl and rubber and makes black wrinkle paint on engines look new. This special formula has been developed without any ozone depleters or chlorinated solvents. This long lasting formula will not streak or spot surfaces, and helps prevent mud and dirt from adhering to treated surfaces.



| DESCRIPTION | QTY/CS | PART # | MFG # |      |   |
|-------------|--------|--------|-------|------|---|
| 11 oz       | 12     | 650196 | 0555  | 9.99 | H |



### LP PREMIUM BRAKE & PARTS CLEANER

Liquid Performance Premium Brake & Parts Contact Cleaner is a concentrated blend of solvents with a powerful blasting spray that effectively removes grease, grime, brake fluid and other contaminants from brake components and other metal parts without the need for disassembly. This ideal brake and parts cleaner evaporates instantly and completely leaving no residue to hinder performance. Contains no ozone depleters.



| DESCRIPTION | QTY/CS | PART # | MFG # |      |   |
|-------------|--------|--------|-------|------|---|
| 14 oz       | 12     | 650192 | 0230  | 6.99 | H |



### LP 20/20 ANTI-FOG CLEANER AND PROTECTANT

LP 20/20 Anti Fog Cleaner & Protectant safely cleans and protects all types of sports gear, clear plastic, Lexan and glass when clear vision is a must. Contains no ammonia and will not damage optical coatings. Use on: Goggles, glasses, face shields, camera lenses, windshields, rifle scopes, Lexan or any other clear surface.

| DESCRIPTION | QTY/CS | PART # | MFG # |      |   |
|-------------|--------|--------|-------|------|---|
| 6 oz        | 12     | 650197 | 0734  | 7.99 | H |



MARINE





## LIQUID PERFORMANCE



### LP PREMIUM CYCLE WASH

Liquid Performance Premium Cycle Wash is a spray on, rinse off, surfactant based formula that lifts dirt from the surface and leaves a shine unequaled by any other cleaner. Liquid Performance Premium Cycle Wash is not a degreaser and will not dissolve grease from bearings. It is safe for all bike surfaces, and will not damage any of today's high tech metal or plastic surfaces when used as directed. Non-corrosive and biodegradable. Available in 32oz Spray as well as 1, 5, 30 & 55 Gallon sizes.

| DESCRIPTION | QTY/CS | PART # | MFG # |       |   |
|-------------|--------|--------|-------|-------|---|
| 32 oz       | 12     | 650173 | 0004  | 7.99  | H |
| 1 Gallon    | 4      | 650174 | 0010  | 18.99 | H |
| 5 Gallon    | N/A    | 650175 | 0223  | 69.95 | H |

### LP PREMIUM ATV/UTV WASH

Liquid Performance Premium ATV Wash is formulated to remove the tough stuff that other cleaners can't. Liquid Performance Premium ATV Wash penetrates dirt, mud, manure or whatever else you can get into on the track, in the woods, or on the farm and leaves your ATV looking showroom clean. It's safe for all ATV finishes when used as directed. Biodegradable and non-corrosive. Available in 32oz Spray as well as 1, 5, 30 & 55 Gallon sizes.

| DESCRIPTION | QTY/CS | PART # | MFG # |       |   |
|-------------|--------|--------|-------|-------|---|
| 32 oz       | 12     | 650178 | 0011  | 7.99  | H |
| 1 Gallon    | 4      | 650179 | 0012  | 18.99 | H |
| 5 Gallon    | N/A    | 650180 | 0155  | 69.99 | H |



### LP PREMIUM STREET BIKE WASH

From Harleys to Sport Bikes, Liquid Performance Premium Street Bike Wash has got you covered with a secret formula that removes grease, bugs, dirt and road grime better than any of the competitors. With it's spray on, rinse off, no scrub formula you will be out cruising while the other guys are still scrubbing. Safe for all bike surfaces including windshields when used as directed. Non-corrosive and biodegradable. Available in 32oz Spray as well as 1, 5, 30 & 55 Gallon sizes.

| DESCRIPTION | QTY/CS | PART # | MFG # |       |   |
|-------------|--------|--------|-------|-------|---|
| 32 oz       | 12     | 650184 | 0013  | 9.99  | H |
| 1 Gallon    | 4      | 650185 | 0014  | 21.99 | H |
| 5 Gallon    | N/A    | 650186 | 0159  | 89.95 | H |

### LP MIRCROFIBER DETAILING CLOTH

Liquid Performance Premium Microfiber Detailing Cloths are the product of recent developments in the manufacture and make-up of fine quality detailing towels. They feature a soft surface that is ideal for high quality cleaning and detailing. They are perfect for use in drying or polishing a car, motorcycle, boat, or any reflective surface, and can absorb up to seven times their dry weight in water. Available in 2 cloth pack or in bulk packaging. 16" x 16".

| DESCRIPTION | QTY/CS | PART # | MFG # |      |   |
|-------------|--------|--------|-------|------|---|
| 2 Pack      | 12     | 650202 | 0438  | 7.99 | H |



- accessories
- towables
- body
- controls
- electrical
- driveline
- engine
- fuel & intake
- chemicals**
- tie downs
- tools
- towing & loading

MARINE



## LIQUID PERFORMANCE

### LP RACING COOLANT & ANTIFREEZE

Liquid Performance Racing Coolant and Anti-freeze with LP3 keeps your motor running at just the right temperature for maximum engine performance in both summer heat and winter cold. Our LP3 additives reduce heat, friction, and internal engine wear and maintained more horsepower than all of the competitors tested. Our Racing Coolant is legal for all AMA sanctioned dirt track racing events. Pre-mixed and ready to use. Propylene glycol based, phosphate free, virtually non-toxic and biodegradable.



**BOILING POINT PROTECTION UP TO 260° F (126.6°C)  
FREEZING POINT PROTECTION DOWN TO -30°F(-34°C)**

| DESCRIPTION | QTY/CS | PART # | MFG # |       |   |
|-------------|--------|--------|-------|-------|---|
| 64 oz       | 4      | 650189 | 0016  | 20.99 | H |



### LP STREET BIKE COOLANT & ANTIFREEZE

If your bike is running hot, then you're not getting peak performance. Reducing heat in the closed loop cooling system helps to maintain your bike's optimum horse-power. We have the solution...LP High Performance Street Bike Coolant. Tested and dyno rated the #1 coolant on the market. Propylene glycol based, phosphate free, virtually non-toxic and biodegradable.

**BOILING POINT PROTECTION UP TO 260° F (126.6°C)  
FREEZING POINT PROTECTION DOWN TO -30°F(-34°C)**

| DESCRIPTION | QTY/CS | PART # | MFG # |       |   |
|-------------|--------|--------|-------|-------|---|
| 64 oz       | 4      | 650190 | 0535  | 20.99 | H |

### LP MINI BIKE RACING COOLANT & ANTIFREEZE

Liquid Performance Minibike Racing Coolant with LP3 is specially formulated for smaller race engines, specifically 50cc to 85cc motorcycles. The benefits of the LP3 additive reduces heat, friction and internal engine wear in the closed loop cooling system. This helps to maintain horsepower while extending engine life. Its lower viscosity results in better coolant flow meaning less work for the smaller high revving engines and their water pumps. Liquid Performance Mini Bike Racing Coolant with LP3 is legal for all AMA sanctioned racing events. Pre-mixed with deionized water so it is ready to use. Propylene glycol based, phosphate free, virtually non-toxic and biodegradable.

**BOILING POINT PROTECTION UP TO 258° F (125.5°C)  
FREEZING POINT PROTECTION DOWN TO -20°F (-23.3°C)**

| DESCRIPTION | QTY/CS | PART # | MFG # |       |   |
|-------------|--------|--------|-------|-------|---|
| 64 oz       | 4      | 650183 | 0535  | 20.99 | H |



### LP ICE WATER NON-GLYCOL RACING COOLANT

Liquid Performance Ice Water Non-Glycol Racing Coolant is a water based coolant designed for racing engines of all types. This innovative product contains no glycols or polyglycols or phosphates making it an environmentally friendly product. Liquid Performance Ice Water Racing Coolant contains a broad spectrum corrosion inhibitor package and is premixed with pure deionized water for protection against ferrous and non-ferrous degradation and corrosion. Proprietary ingredients are designed to provide maximum heat transfer in the most extreme temperatures and operating conditions allowing for greater horsepower without overheating. Meets the most stringent racing specifications and is AMA Pro Racing, WERA, CCS, and ASRA track approved for all race classes. Virtually non toxic and biodegradable.

**BOILING POINT PROTECTION UP TO 212° F (100°C)  
THIS PRODUCT OFFERS NO FREEZE PROTECTION**



| DESCRIPTION | QTY/CS | PART # | MFG # |       |   |
|-------------|--------|--------|-------|-------|---|
| 64 oz       | 4      | 650191 | 0699  | 18.99 | H |

- accessories
- towables
- body
- controls
- electrical
- driveline
- engine
- fuel & intake
- chemicals
- tie downs
- tools
- towing & loading



## THREEBOND



### RTV SEALANT - GRAY

- RTV sealant (gray) high viscosity gasket maker.
- OEM specified product
- Good elasticity
- Temperature, chemical, oil, water, coolant, and gasoline resistant
- Excellent as a general purpose LGM
- High resistance to heat and cold

| DESCRIPTION | QTY/CS | PART # | MFG #               |
|-------------|--------|--------|---------------------|
| 3.8 oz      | 6      | 414000 | TB1200GAU3Z 13.95 G |



**GROUND ONLY**

**GROUND ONLY**

### GASKET MAKER - GRAY

- High viscosity FIPG (form-in-place-gasket) gasket-maker
- OEM specified product
- Good adhesion properties in power-train and small engine applications
- Allows immediate service after application
- Non-slumping formulation 'holds-in-place'
- High resistance to engine and gear oil
- FIPG properties allow for greater 'gap' fill

| DESCRIPTION | QTY/CS | PART # | MFG #           |
|-------------|--------|--------|-----------------|
| 5.3 oz      | 6      | 414001 | TB1217H 18.95 G |

- accessories
- towables
- body
- controls
- electrical
- driveline
- engine
- fuel & intake
- chemicals
- tie downs
- tools
- towing & loading

### GASKET MAKER - BLACK

- High performance
- High viscosity
- High temp resistance
- High adhesion.
- High torque endurance
- High vibration endurance
- Liquid gasket maker used on more than 5 Million engines
- Non-slumping paste
- Highly effective In continuous vibrating conditions
- Good adhesion to plastic

| DESCRIPTION | QTY/CS | PART # | MFG #           |
|-------------|--------|--------|-----------------|
| 3.5 oz      | 12     | 414002 | TB4207B 31.95 G |



**GROUND ONLY**

### RTV SEALANT GRAY, LOW VISCOSITY, SOLVENTLESS

- High performance gasket maker
- Excellent heat/chemical and gear oil resistance

| DESCRIPTION | QTY/CS | PART # | MFG #        |
|-------------|--------|--------|--------------|
| 8.8 oz      | 6      | 414003 | TB1215 28.95 |



**GROUND ONLY**

MARINE

- accessories
- towables
- body
- controls
- electrical
- driveline
- engine
- fuel & intake
- chemicals
- tie downs
- tools
- towing & loading



GROUND ONLY

### SUPER GLUE

- ThreeBond Super Glue attains practical use strength in a matter of seconds
- Contains no evaporative elements, so there's never any shrinkage to weaken bonding points
- Excellent for non-porous materials

| DESCRIPTION | QTY/CS | PART # | MFG #     |        |
|-------------|--------|--------|-----------|--------|
| 2 Grams     | 36     | TB1720 | 1742BT020 | 7.95 G |

### LIQUID GASKET

- Excellent padding properties make this semi-drying, visco-elastic sealer the perfect product for sealing joint surfaces with large clearance
- Special synthetic rubber provides excellent cushion to absorb vibrations and impacts without failure, esp. where coolants are involved
- O.E. motorcycle manufacturers have successfully used this high reliability liquid gasket in numerous applications
- Comes in 3.5 oz tubes

| DESCRIPTION | QTY/CS | PART # | MFG #      |         |
|-------------|--------|--------|------------|---------|
| 3.5 oz      | 24     | TB1184 | 1194A100GA | 12.95 G |



GROUND ONLY

### SYNTHETIC RUBBER ADHESIVE

- ThreeBond 1521 is a contact cement which is a multi-purpose, rubber based adhesive that gives excellent bonding characteristics to a wide variety of materials including rubber, plastic, vinyl, metal, leather, woods, ceramics and more
- Provides a strong, waterproof bond and sets up within 5-10 minutes depending on temperature and humidity



GROUND ONLY

| DESCRIPTION | QTY/CS | PART #   | MFG #       |         |
|-------------|--------|----------|-------------|---------|
| 5.3 oz      | 12     | SOLD OUT | 1521A150GM  |         |
| 75 Grams    | 12     | 414004   | 7731521A75G | 11.95 G |

### INSTANT ADHESIVE GEL TYPE

- Three Bond 1762 is a thixotropic gel
- Once applied, the gel stays in place and will not run off parts to be bonded

| DESCRIPTION | QTY/CS | PART # | MFG #    |         |
|-------------|--------|--------|----------|---------|
| 20 Grams    | 12     | TB1762 | 1762B20G | 12.95 G |



GROUND ONLY

### SILICONE LIQUID GASKET

- ThreeBond 1211 Silicone Liquid Gasket is a tough durable sealer utilizing silicone rubber as a primary component
- White in color, its solventless, semi-drying and visco-elastic properties make it ideal for numerous applications where a long lasting, faultless seal is absolutely critical; as it comes in contact with air, it forms a rubberized, elastic mass impervious to vibrations and impacts
- Can be applied to flange surfaces and screw sections to prevent water, oil, gasoline and chemical leaks
- 100% effective over a wide temperature range - 76° to 482°F. Tack-free in 90 minutes; fully cured and bonded within 24 hours; attains optimum strength in three days
- Recommended for: motorcycle, personal watercraft, ATV engines



GROUND ONLY

| DESCRIPTION | QTY/CS | PART # | MFG #     |         |
|-------------|--------|--------|-----------|---------|
| 3.5 oz      | 6      | TB1211 | 1211AT100 | 25.95 G |

# ThreeBond

# THREEBOND

## GRIPLOCK

- A high adhesive specially formulated to keep grips in place without damaging the rubber
- Griplock puts an end to grips twisting or sliding off
- Ideal for motorcycle, personal watercraft, snowmobiles and atvs



| DESCRIPTION | QTY/CS | PART # | MFG #     |       |   |
|-------------|--------|--------|-----------|-------|---|
| 1 oz        | 12     | TB1501 | 1501CT100 | 10.95 | G |
| 10 Grams    | 24     | TB1505 | 1501CT102 | 7.95  | G |

accessories

towables

body

controls

electrical

driveline

engine

fuel & intake

chemicals

tie downs

tools

towing & loading

## CLEAR SILICONE SEALANT



- A low odor, fast setting, non slumping paste that cures at room temperature to a rubbery solid
- This multi-purpose RTV silicone sealant can be used in numerous bonding and sealing applications such as: pumps, gearboxes, marine cabins, windows and electrical boxes

| DESCRIPTION | QTY/CS | PART # | MFG #    |       |   |
|-------------|--------|--------|----------|-------|---|
| 3 oz        | 12     | TB1212 | 1212C85G | 15.95 | G |

## SEAL 'N' AIR FOR TUBE/TUBELESS TIRES



- ThreeBond's temporary flat tire repair require no tools
- For best results, remove foreign object before inflating
- Aerosol can inflates tire to moderate pressure in only 20 seconds
- Upon resuming riding, white foaming fluid spreads evenly inside tire, sealing the leak
- Tire pressure increases gradually while riding
- Not effective for large holes or sidewall punctures
- Works at temperatures 239° F and above
- For temperatures below 23° F, container may be warmed with hands (not flame) before using

| DESCRIPTION  | QTY/CS | PART # | MFG #     |       |   |
|--------------|--------|--------|-----------|-------|---|
| Seal 'N' Air | 12     | TB6000 | 60T004A6Z | 13.95 | G |



## PLASTIC REPAIR KIT

REPAIRS: PLASTIC, FUEL TANKS, HOLDING TANKS, WATER TANKS, ETC.

- Simple, effective way to repair cracked or broken plastic
- **Kit** includes: full instructions, glue, primer, accelerator, sandpaper, fibercloth (30" x 1.5"), enough material to repair four to five 6" breaks
- Not recommended for fiberglass
- **Mini kit** contains: enough material to repair approximately two 6" breaks



| DESCRIPTION | QTY/CS | PART # | MFG #      |       |   |
|-------------|--------|--------|------------|-------|---|
| Kit         | 6      | TB1743 | 1743APLRKT | 46.95 | G |
| Mini Kit    | 12     | TB1745 | 17MPRK     | 37.95 | G |



# MARINE

- accessories
- towables
- body
- controls
- electrical
- driveline
- engine
- fuel & intake
- chemicals
- tie downs
- tools
- towing & loading



### HI STRENGTH RETAINING

ThreeBond's High strength retaining properties for various threads, screws, bolts, piping joints, gears, pulleys and fans which are not frequently removed or must remain secure for safety and/or structural integrity reasons

| DESCRIPTION | QTY/CS | PART #        | MFG #     |              |   |
|-------------|--------|---------------|-----------|--------------|---|
| 10 ml       | 6      | <b>TB1303</b> | 1303AT000 | <b>10.95</b> | G |
| 50 ml       | 12     | <b>TB2303</b> | 1303A50C  | <b>21.95</b> | G |

### LOW STRENGTH/ FREQUENT REPAIR

ThreeBond's Low Strength Frequent Repair product is perfect for small screws and bolts which are frequently removed and require a force of only 10-20% greater than that used for tightening

| DESCRIPTION | QTY/CS | PART #        | MFG #     |              |   |
|-------------|--------|---------------|-----------|--------------|---|
| 10 ml       | 6      | <b>TB1342</b> | 1342AT002 | <b>10.95</b> | G |
| 50 ml       | 12     | <b>TB2342</b> | 1342A50C  | <b>21.95</b> | G |



### BEARING AND STUD LOCK

ThreeBond's Bearing & Stud Lock includes high strength retaining properties for bearings and studs which are not frequently removed and must remain secure for safety or structural integrity reasons

| DESCRIPTION | QTY/CS | PART #        | MFG #     |              |   |
|-------------|--------|---------------|-----------|--------------|---|
| 10 ml       | 6      | <b>TB1333</b> | 1333BT001 | <b>10.95</b> | G |
| 50 ml       | 12     | <b>TB2333</b> | 1333B50C  | <b>21.95</b> | G |

### HI TEMPERATURE

ThreeBond's Hi Temperature Thread Lock is a new sealing and locking agent made to withstand extreme temperatures without weakening. Incorporates various strengths of anaerobic locking agents which makes it ideal for sealing engine and exhaust components.

| DESCRIPTION | QTY/CS | PART #        | MFG #     |              |   |
|-------------|--------|---------------|-----------|--------------|---|
| 10 ml       | 6      | <b>TB1360</b> | 1360AT003 | <b>10.95</b> | G |
| 50 ml       | 12     | <b>TB2360</b> | 1360A50C  | <b>21.95</b> | G |





## EPOXY ADHESIVES

“World’s Finest Cold Weld Compound”  
#1 Brand for consumers and professionals on the market today.

### J-B WELD ORIGINAL COLD WELD FORMULA STEEL REINFORCED EPOXY

- Great for household repairs, automotive, plumbing, marine, crafts and more
- Its two-part epoxy system that provides strong, lasting repairs to metal and multiple surfaces
- Mixed at a ratio of 1:1, it forms a permanent bond and can be shaped, tapped, filed, sanded and drilled after curing
- At room temperature, J-B Weld sets in 20-25 minutes to a dark grey color
- A full cure is reached in 15-24 hours, and sets to a hard bond overnight
- Has a tensile strength of 3960 PSI
- Can withstand temperatures up to 550° F when fully cured
- Sold each
- Display packaged

| DESCRIPTION                         | PART # | MFG #  |       |   |
|-------------------------------------|--------|--------|-------|---|
| J-B Weld                            | JB8265 | 8265-S | 6.95  | G |
| J-B Weld Professional Size - 10 oz. | 446002 | 8280   | 19.60 | G |



### J-B KWIKWELD QUICK-SETTING STEEL REINFORCED EPOXY

- J-B KwikWeld is a quick-setting steel reinforced epoxy
- J-B KwikWeld is a fast setting version of The Original J-B Weld two-part epoxy cold weld system
- Provides strong, lasting repairs to metal and multiple other surface types
- Great for household repairs, automotive, plumbing, marine, crafts and more
- After mixing, it forms a permanent bond and can be shaped, tapped, filed, sanded and drilled after curing
- 1:1 mixing ratio
- Sets in 6 minutes and is fully cured in 4-6 hours
- Cures to a dark grey color
- Rated at a tensile strength of 2424 PSI
- Will withstand temperatures up to 300° F
- Sold each
- Display packaged

| DESCRIPTION                             | PART # | MFG # |       |   |
|---|--------|-------|-------|---|
| J-B KwikWeld                            | JB8276 | 8276  | 6.95  | G |
| J-B KwikWeld Syringe - 25 mL            | 446020 | 50176 | 7.72  | G |
| J-B KwikWeld Professional Size - 10 oz. | 446001 | 8270  | 22.95 | G |



### J-B MARINE WELD MARINE EPOXY

- J-B MarineWeld is a specially formulated two-part epoxy cold weld system that provides for strong, lasting repairs for bonding different or similar surfaces, such as aluminum, metal, composites, fiberglass and others
- Great for use on boats, personal watercraft, in/outboard engines, deck and hull accessories
- Sets in 20-25 minutes at room temperature and is fully cured to a dark grey color in 15-24 hours
- Once cured, it can be shaped, tapped, filed, sanded and drilled and will retain its strength above or below the waters' surface
- MarineWeld has a 1:1 mixing ratio
- Tensile strength of 3960 PSI
- Sold each
- Display packaged

| DESCRIPTION                    | PART # | MFG # |      |   |
|--------------------------------|--------|-------|------|---|
| J-B MarineWeld                 | JB8272 | 8272  | 6.95 | G |
| J-B MarineWeld Syringe - 25 mL | 446019 | 50172 | 9.09 | G |



- accessories
- towables
- body
- controls
- electrical
- driveline
- engine
- fuel & intake
- chemicals
- tie downs
- tools
- towing & loading

# MARINE



## EPOXY ADHESIVES

“World’s Finest Cold Weather Compound”  
#1 Brand for consumers and professionals on the market today.

### J-B WOODWELD QUICK-SETTING WOOD EPOXY

J-B WoodWeld is a fast setting two-part epoxy system formulated for wood bonding and repairs. When fully cured it can be shaped, tapped, filed, sanded and drilled. It provides a lasting permanent bond that is stronger than the wood! J-B WoodWeld has a 1:1 mixing ratio, sets in 6 minutes and cures in 1-3 hours. Rated at a tensile strength of 1800 PSI, J-B WoodWeld cures to a light tan color.

Great For:

- Indoor/Outdoor
- Furniture
- Doors
- Windows
- Trim/Molding
- Decks & More

| DESCRIPTION                  | PART # | MFG # |        |
|------------------------------|--------|-------|--------|
| J-B WoodWeld Syringe - 25 mL | 446018 | 50151 | 8.36 G |



### J-B CLEARWELD QUICK SETTING EPOXY

ClearWeld is a quick setting, multipurpose two part epoxy that provides a strong and lasting bond on most surfaces including tile, most plastics, ceramic, glass, wood and metal. ClearWeld is designed to cure with a clear, transparent bond when used at thicknesses of less than 15 mil. ClearWeld has a 1:1 mixing ratio, sets in 5 minutes and cures in 1 hour. With a tensile strength of 4400 PSI, ClearWeld sets to a hard, permanent bond.

Great For:

- Tile
- Most Plastics
- Ceramic
- Glass
- Wood
- Metal

| DESCRIPTION                  | PART # | MFG # |        |
|------------------------------|--------|-------|--------|
| J-B ClearWeld Syringe - 25mL | 446015 | 50112 | 6.42 G |



### J-B PLASTICWELD QUICK SETTING EPOXY

PlasticWeld is a specially formulated two-part adhesive and epoxy filler system that provides for strong, lasting repairs. PlasticWeld will bond a variety of surfaces, such as metal, composites, fiberglass and others. PlasticWeld sets in 5 minutes at room temperature and is fully cured in 1 hour. Using a 1:1 mixing ratio, PlasticWeld combines to a tensile strength of 3200 PSI and cures to an off-white color.

Great For:

- Most Hard Plastics
- ABS
- Fiberglass
- PVC
- Glass
- Vinyl
- Most Composites

| DESCRIPTION                     | PART # | MFG # |        |
|---------------------------------|--------|-------|--------|
| J-B PlasticWeld Syringe - 25 mL | 446016 | 50132 | 6.46 G |



### J-B MINUTEWELD

MinuteWeld is a fast setting, multipurpose two part epoxy that provides a strong and lasting bond on most surfaces including tile, most plastics, ceramic, glass, wood and metal. MinuteWeld is designed to bond instantly and cure with a clear, transparent bond when used at thicknesses of less than 15 mil. MinuteWeld has a 1:1 mixing ratio, sets in 1 minute and will fully cure overnight. With a tensile strength of 3200 PSI, MinuteWeld sets to a hard, permanent bond.

- Stronger than Super glues
- Highest Strength in Class
- Our Clearest Weld
- Features No Waste, No mess cap.

| DESCRIPTION                    | PART # | MFG # |        |
|--------------------------------|--------|-------|--------|
| J-B MinuteWeld Syringe - 25 mL | 446014 | 50101 | 7.72 G |



accessories  
towables  
body  
controls  
electrical  
driveline  
engine  
fuel & intake  
chemicals  
tie downs  
tools  
towing & loading

MARINE





## EPOXY PUTTY STICKS

“World’s Finest Cold Weather Compound”  
#1 Brand for consumers and professionals on the market today.

### J-B WATERWELD WILL SET UNDER WATER!

- WaterWeld will plug or seal leaks and patch holes and cracks in almost anything
- Ideal for repairing plumbing, fuel tanks, tub and shower, drains, pool and spa, boats and potable water tanks; setup occurs even under water
- After curing, it can be drilled, tapped, filed, sanded and painted
- Has a set time of 15-25 minutes and sets hard in one hour
- Cures to an off-white color
- Rated at a tensile strength of 900 PSI
- Will withstand temperatures up to 300° F
- Sold each. Display packaged.



| DESCRIPTION   | PART # | MFG # |      |   |
|---------------|--------|-------|------|---|
| J-B WaterWeld | JB8277 | 8277  | 8.95 | G |

### J-B WELD KWIK WOOD REPAIR AND REBUILD ANYTHING MADE OF WOOD!

- Repair and rebuild anything made of wood such as dry rot, knot holes, window and door frames, screw holes, insect damage, furniture and carvings, gouges and cracks, and PVC trim board
- KwikWood is a hand-mixable epoxy putty, formulated to repair and rebuild wood
- After mixing, it cures to the same density as wood and becomes an integral part of the repair
- For use on exterior or interior applications, it contains no solvents, will not rot, shrink, crack or pull away
- KwikWood has a 15-25 minute work life
- After 60 minutes, it can be machined, drilled, tapped, sanded, filed and painted
- Stronger than wood, KwikWood dries to a light tan color
- Sold each. Display packaged.



| DESCRIPTION   | PART # | MFG # |      |   |
|---------------|--------|-------|------|---|
| J-B Kwik Wood | JB8257 | 8257  | 7.95 | G |

### J-B PLASTICWELD REPAIR AND REBUILD ANYTHING MADE OF ABS, PVC, & CPVC!

- PlasticWeld is a hand-mixable, fast-setting epoxy putty that forms a durable bond to most major plastic types
- After mixing, it forms a polymer compound that can be molded or used to build up and repair just about anything made from plastic
- When cured, it can be sawed, drilled, carved, sanded and painted
- PlasticWeld has a 20-25 minute work life; functional cure occurs in 2-3 hours
- Cures to an off-white color
- Rated at a tensile strength of 350 PSI
- Does not adhere to polyethylene, polypropylene or some other plastics
- Test for adhesion first
- Sold each. Display packaged.



| DESCRIPTION     | PART # | MFG # |      |   |
|-----------------|--------|-------|------|---|
| J-B PlasticWeld | JB8237 | 8237  | 8.95 | G |



## HYDRO TURF CONTACT CEMENT

16 oz can liquid contact cement. Great for all your Hydro-Turf mat applications!

| DESCRIPTION        | PART # | MFG # |       |   |
|--------------------|--------|-------|-------|---|
| 16 oz Dap Weldwood | 967168 | CC20  | 14.00 | E |



- accessories
- towables
- body
- controls
- electrical
- driveline
- engine
- fuel & intake
- chemicals
- tie downs
- tools
- towing & loading

# MARINE

# CHEMICALS



## SPECIALTY PRODUCTS

“World’s Finest Cold Weather Compound”  
#1 Brand for consumers and professionals on the market today.

accessories

towables

body

controls

electrical

driveline

engine

fuel & intake

chemicals

tie downs

tools

towing & loading

MARINE

### J-B PLASTIC BONDER BODY PANEL ADHESIVE, FILLER & SEALER

Strength 3770 PSI  
Set Time 15 Minutes  
Sand in 30 Minutes  
Dries Tan

Great For:

- Filling Dents
- Bumpers
- Automotive Trim
- Composite Panels
- Interior & Exterior Plastic Parts
- Polypropylene & Polyethylene Plastics
- Fiberglass

Plastic Bonder is a quick-setting, two-part, urethane adhesive system that provides strong and lasting repair and works on thermoset, carbon fiber composites, thermoplastics, coated metals, concrete & more. Plastic Bonder has a 1:1 mixing ratio, sets in 15 minutes and can be sanded after 30 minutes. With a tensile strength of 3770 PSI, Plastic Bonder sets to a tan color and cures to a hard, permanent bond.



| DESCRIPTION                       | PART # | MFG # |        |
|-----------------------------------|--------|-------|--------|
| J-B PlasticBonder Syringe - 25 mL | 446017 | 50133 | 7.94 G |

### J-B HIGHHEAT TEMPERATURE RESISTANT EPOXY PUTTY

Strength 800 PSI at Room Temp. 600 PSI at 400°F  
Set Time 1 Hour  
Functional Cure 8 Hours  
Dries Machine Grey

Great For:

- Exhaust Manifolds
- Tail Pipes
- Mufflers
- Engine Blocks
- Duct Work
- Machinery
- High Temperature Projects

HighHeat is a hand mixable epoxy putty stick specifically formulated to bond and repair materials that will be exposed to high temperatures in automotive and industrial maintenance applications. It cures to a tough, hard bond with little to no shrinkage. This industrial-strength product outperforms conventional epoxy putties at high temperatures and sets in 1 hour at room temperature. After 8 hours, it can be drilled, tapped, machined, ground, filed and painted. HighHeat is rated at a tensile strength of 800 PSI and cures to a machine grey in color. It is able to withstand continuous heat exposure of 400°F and intermittent heat exposure to 550°F



| DESCRIPTION             | PART # | MFG # |        |
|-------------------------|--------|-------|--------|
| J-B HighHeat Epoxy Stik | 446003 | 8297  | 8.95 G |

### J-B PERM-O-SEAL RADIATOR STOP LEAK

Great for:

- Permanent Repairs for All Car, Truck, Van, Bus and Tractor Radiators
- Will Not Clog or Harm Cooling System

J-B Weld Perm-O-Seal is a specially formulated non-toxic compound ground to a very fine particle size to quickly mix and flow into all areas of the cooling system to find and seal leaks. The powdered concentrate allows for an economical repair as compared to liquid based alternatives that use similar technology. The special compound will quickly seal leaks and will also act as a rust inhibitor and lubricant to internal cooling system parts. It will not clog or harm your cooling system.



| DESCRIPTION              | PART # | MFG #  |        |
|--------------------------|--------|--------|--------|
| J-B Perm-O-Seal (Carded) | 446004 | DS-114 | 2.54 G |



## SILICONE SEALANTS

“World’s Finest Cold Weather Compound”  
#1 Brand for consumers and professionals on the market today.

### J-B WELD CLEAR SILICONE

- J-B Weld Clear Silicone
- Sealant & Adhesive
- RTV all purpose technology
- Set time 1 hour
- Fully cured 24 hours
- Waterproof
- All purpose (auto, household)

| DESCRIPTION                   | PART # | MFG # |        |
|-------------------------------|--------|-------|--------|
| J-B Clear RTV Acetoxy - 3 oz. | 446005 | 31310 | 5.95 G |

### J-B WELD BLACK SILICONE

- J-B Weld Black Silicone
- RTV all purpose technology
- Set time 1 hour
- Fully cured 24 hours
- Mold and Mildew Resistant
- Auto and Household
- Bonding and Sealing
- Weather Stripping, Moldings

| DESCRIPTION                   | PART # | MFG # |        |
|-------------------------------|--------|-------|--------|
| J-B Black RTV Acetoxy - 3 oz. | 446009 | 31319 | 4.95 G |

### J-B WELD BLUE SILICONE

- J-B Weld Blue Silicone
- RTV all purpose technology
- Set time 1 hour
- Sensor Safe
- Gasket Maker and Sealant
- Auto and Household
- Timing Gear Covers
- Transmission & Oil Pans

| DESCRIPTION                  | PART # | MFG # |        |
|------------------------------|--------|-------|--------|
| J-B Blue RTV Acetoxy - 3 oz. | 446008 | 31316 | 5.95 G |

### J-B WELD WHITE SILICONE

- J-B Weld White Silicone
- RTV 100% Silicone
- Waterproof Sealant & Adhesive
- Set time 1 hour
- Mold and Mildew Resistant
- Tub & Shower
- Sinks & Bathroom Fixtures
- Windows, Interior Trim, Door Frames
- Moldings and Lens Housing

| DESCRIPTION                   | PART # | MFG # |        |
|-------------------------------|--------|-------|--------|
| J-B White RTV Acetoxy - 3 oz. | 446006 | 31312 | 5.95 G |



accessories

towables

body

controls

electrical

driveline

engine

fuel & intake

chemicals

tie downs

tools

towing & loading

MARINE



## SILICONE SEALANTS

"World's Finest Cold Weather Compound"  
#1 Brand for consumers and professionals on the market today.

### J-B WELD ULTIMATE GREY SILICONE

- J-B Weld Ultimate Grey Silicone
- Oxime RTV 100% Silicone
- Gasket Maker and Sealant
- High Torque Load Applications
- Import Cars (Honda, Toyota, Nissan etc.)
- Maximum Oil Resistance
- Set time 1 hour
- Temperature Resistant up to 500° F
- Intake Manifolds
- Low Odor, Non Corrosive and Sensor Safe
- Oil Pans and Timing Gear Covers
- Transmission Pans and Cam Covers

| DESCRIPTION                                      | PART # | MFG # |        |
|--|--------|-------|--------|
| J-B Ultimate Grey Oxime - 3 oz.                  | 446012 | 32327 | 7.95 G |
| J-B Grey Water, Pump, & Thermostat Oxime - 5 oz. | 446010 | 32507 | 3.95 G |



### J-B WELD ULTIMATE BLACK SILICONE

- J-B Weld Ultimate Black Silicone
- Oxime RTV 100% Silicone
- Maximum Oil Resistance
- Set time 1 hour
- Temperature Resistant up to 500° F
- Low Odor and Sensor Safe
- Oil Pans and Valve Covers
- Transmission Pans
- Timing Gear Covers

| DESCRIPTION                      | PART # | MFG # |        |
|----------------------------------|--------|-------|--------|
| J-B Ultimate Black Oxime - 3 oz. | 446013 | 32329 | 6.95 G |
| J-B Maxi Black Oxime - 5 oz.     | 446011 | 32509 | 3.95 G |



### J-B WELD HI TEMP RED SILICONE

- J-B Weld Hi Temp Red Silicone
- RTV all purpose technology
- Set time 1 hour
- Temp. Resistant up to 650° F
- Gasket Maker and Sealant
- Oil Pans and Valve Covers
- Exhaust Manifolds and Water Pumps
- Timing and Differential Covers

| DESCRIPTION                        | PART # | MFG # |        |
|------------------------------------|--------|-------|--------|
| J-B High Temp. Red Acetoxy - 3 oz. | 446007 | 31314 | 6.95 G |



accessories  
towables  
body  
controls  
electrical  
driveline  
engine  
fuel & intake  
chemicals  
tie downs  
tools  
towing & loading

MARINE



## THREADLOCKERS

J-B Weld threadlockers are superior to conventional mechanical devices because they secure the entire fastener assembly against loosening from shock and vibration so fastener clamping forces are maintained. Threadlockers seal the threads against leakage and prevent rust and corrosion.

“World’s Finest Cold Weather Compound”  
#1 Brand for consumers and professionals on the market today.

### J-B WELD PERMA-LOCK MEDIUM STRENGTH THREADLOCKER

- 1/4" to 1" fasteners that have a slight oil film.
- Prevents vibration loosening.
- Temperature resistant to 300°F.
- Features a no spill, drip or clog cap.
- OEM approved.
- Suggested applications: rocker arms, stud bolts, fasteners & bushings, loose screws, vibration sensitive items.



| DESCRIPTION | PART #  | MFG # |       |   |
|-------------|---------|-------|-------|---|
| 6 mL        | JB24206 | 24206 | 6.95  | G |
| 13 mL       | JB24213 | 24213 | 14.95 | G |
| 36 mL       | 446025  | 24236 | 22.95 | G |
| 50 mL       | 446026  | 24250 | 34.95 | G |

### J-B WELD PERMA-LOCK HIGH STRENGTH THREADLOCKER

- For heavy-duty applications. Temperature resistant to 300°F.
- Especially well suited for permanently locking studs.
- Locks against vibration loosening.
- Requires extra effort or special tools for removal.
- Features a no spill, drip or clog cap.
- OEM approved.
- Suggested applications: rocker arms, stud bolts, fasteners & bushings, loose screws, vibration sensitive items.



| DESCRIPTION | PART # | MFG # |       |   |
|-------------|--------|-------|-------|---|
| 6 mL        | 446021 | 27106 | 6.95  | G |
| 13 mL       | 446022 | 27113 | 14.95 | G |
| 36 mL       | 446023 | 27136 | 22.95 | G |
| 50 mL       | 446024 | 27150 | 34.95 | G |

### J-B WELD PERMA-LOCK LOW VISCOSITY THREADLOCKER

- Low viscosity, penetrating grade threadlocker
- For use on fasteners, screws, electrical connectors and pre-assembled parts
- Temperature resistant to 300 degree Fahrenheit
- Penetrates between part surfaces, so no disassembly is required
- OEM approved



| DESCRIPTION | PART # | MFG # |      |   |
|-------------|--------|-------|------|---|
| 6 mL        | 446027 | 29006 | 6.95 | G |

accessories

towables

body

controls

electrical

driveline

engine

fuel & intake

chemicals

tie downs

tools

towing & loading

MARINE

- accessories
- towables
- body
- controls
- electrical
- driveline
- engine
- fuel & intake
- chemicals
- tie downs
- tools
- towing & loading

## MARINE CLEANING & DETAILING



# BikeBrite

**Ride Hard. Clean Easy.**

### BLUE BUSTER® KIT

Exclusive polishing gel that removes the blue and yellow discoloration from chrome pipes. The kits are packages with one handy drill pad and drill bit and one 8 oz bottle of our exclusive polishing gel. The kits can also be used for removing scratches and surface imperfections in clear coats. Blue Buster® is great for polishing chrome and aluminum and for restoring gloss to painted surfaces.

| DESCRIPTION                     | QTY/CS | PART # | MFG #  |         |
|---------------------------------|--------|--------|--------|---------|
| Blue Buster Polishing Kit, 8 oz | 4      | 962000 | BB-100 | 24.95 G |

### BLUE BUSTER® POWDER

Specially formulated to remove bluing on metals, especially the hard to clean exhaust pipe bluing familiar to all bike owners. Blue Buster® is also great for chrome and other metallic trims and accessories keeping them brilliant and protected.

| DESCRIPTION              | QTY/CS | PART # | MFG #  |        |
|--------------------------|--------|--------|--------|--------|
| Blue Buster Powder, 1 oz | 24     | 962001 | BB-200 | 6.95 L |



### BIKE BAG® CONDITIONER

Bike Bag® creates miracles on leather and vinyl items keeping them in or restoring them to - their original luster. And it's simple to use; apply Bike Bag® to surface, polish and lightly wipe it away. You'll like the look and feel that Bike Bag® Conditioner gives your leather and vinyl accessories! Bike Bag is great for jackets, chaps, gloves, boots, saddle bags or any other item made of vinyl or leather.

| DESCRIPTION                        | QTY/CS | PART # | MFG #      |        |
|------------------------------------|--------|--------|------------|--------|
| Leather & Vinyl Conditioner, 12 oz | 12     | 962002 | MC00048-12 | 8.95 L |

### BIKE BRITE ULTRA

The Number-one name in motorcycle washes has now developed a unique and special cleaning formula for the Off Road and ATV market. The powerful active ingredients in Bike Brite Ultra have been modified to handle the caked on mud, clay and grime of all off-road and all-terrain vehicles. Simply spray the "high cling" foam formula onto all vehicle surfaces. The powerful surfactants and cleaning agents penetrate the caked on clay and mud, loosen and allow the grime to be easily hosed away or wiped away.

| DESCRIPTION  | QTY/CS | PART # | MFG # |         |
|--------------|--------|--------|-------|---------|
| Ultra, 32 oz | 12     | 962013 | MC44U | 11.95 J |



### MOTORCYCLE SPRAY WASH

Bike Brite's fantastic triple action formula washes, cleans and degreases from headlight to taillight! Specially formulated for motorcycles and motorbikes, Bike Brite has been recommended and approved by leading motorcycle manufacturers. Biodegradable, non-acid, pH controlled and containing corrosion inhibitors. Special brighteners help keep rust and grease from forming. Just spray it on and hose it off. What could be easier?

| DESCRIPTION                           | QTY/CS | PART # | MFG #  |         |
|---------------------------------------|--------|--------|--------|---------|
| Spray Wash, 32 oz                     | 12     | 962008 | MC44   | 11.95 J |
| Spray Wash Refill, 1 Gallon (128 oz)  | 4      | 962009 | MC441G | 27.95 G |
| Spray Wash Refill, 1/2 Gallon (64 oz) | 6      | 962010 | MC44R  | 18.95 J |
| Spray Wash 6 Pack P.O.P. Display      | N/A    | 962011 | MC44D  | 72.99 J |
| Spray Wash Travel Size, 16.9 oz       | 12     | 962012 | MC44TR | 7.95 H  |

# BikeBrite

Ride Hard. Clean Easy.

## HELMET LINER REFRESHNER®

Cleaner and deodorizer for helmet liners. Helmet Liner Refreshner cleans, freshens and deodorizes all foam helmet liners. Just spray and wipe dry.



| DESCRIPTION                            | QTY/CS | PART # | MFG #   |      |   |
|--|--------|--------|---------|------|---|
| Helmet Liner Refreshner, 14 oz Aerosol | 6      | 962004 | MC19000 | 7.95 | H |



## MOTO-SHINE®

Moto-Shine® gives you a "Show Bike Shine in Half the Time." Formulated with our exclusive formula, Moto-Shine® brings an instant brilliant shine to your motorcycle. Moto-Shine® lightly cleans, removes harmful contaminants and saves cleaning time, so you can have more riding time. Time conscious bike owners can restore that "just waxed" appearance in five minutes. Bike finishes that have a light dust layer or that have been through a rain storm, can be safely cleaned and shined with Moto-Shine's® gentle formula. For all paint finishes, For all chrome finishes, Just spray and wipe. Moto-Shine® protects your motorcycle against acid rain, oxidation and pollutants.

| DESCRIPTION                      | QTY/CS | PART # | MFG #    |       |   |
|----------------------------------|--------|--------|----------|-------|---|
| Moto-Shine, 32 oz                | 12     | 962005 | MC25000  | 11.95 | H |
| Moto-Shine 6 Pack P.O.P. Display | N/A    | 962006 | MC25000D | 11.95 | G |

## CHAIN LUBE

The lubricator that keeps the kinks out! For use on motorcycles, bicycles, scooters and snowmobiles.



| DESCRIPTION              | QTY/CS | PART # | MFG #   |      |   |
|--------------------------|--------|--------|---------|------|---|
| Chain Lube, 5 oz Aerosol | 12     | 962007 | MC39000 | 8.95 | H |



## BIKE WIPES®

Protects your gas tank from spills and removes dirt and bugs from your windshield, face shield, mirrors and glasses. Bike Wipes® are packaged in a convenient "travel pack" to go along for the ride. They are safe to use on metals, plastics, fiberglass and chrome.

| DESCRIPTION                              | QTY/CS | PART # | MFG #   |      |   |
|--|--------|--------|---------|------|---|
| 5" x 6" Multi-Purpose Cleaning Wipes, 24 | 12     | 962014 | MC49000 | 8.95 | G |

## MOTO BLACK®

Moto Black® cleans, shines and protects black wrinkled and powder coated engine parts. Great for black engine fins, inter-primaries, break calipers, wheel rims and frames. Moto Black® brings back that black factory look to your powder coated parts and accessories.

| DESCRIPTION                      | QTY/CS | PART # | MFG #    |      |   |
|----------------------------------|--------|--------|----------|------|---|
| Moto Black, 9 oz                 | 12     | 962015 | MC53000  | 8.95 | H |
| Moto-Black 3 Pack P.O.P. Display | N/A    | 962016 | MC53000D | 8.95 | G |



## PLEXI BRITE®

Cleaner and polisher for windshields. Cleans and polishes all plastics. Removes bugs from all plastic parts. Just spray and wipe.

| DESCRIPTION                | QTY/CS | PART # | MFG #   |      |   |
|----------------------------|--------|--------|---------|------|---|
| Plexi Brite, 14 oz Aerosol | 6      | 962018 | MC69000 | 7.95 | H |

POLISHES & PROTECTANTS

- accessories
- towables
- body
- controls
- electrical
- driveline
- engine
- fuel & intake
- chemicals
- tie downs
- tools
- towing & loading

MARINE

- accessories
- towables
- body
- controls
- electrical
- driveline
- engine
- fuel & intake
- chemicals
- tie downs
- tools
- towing & loading

# MARINE WAXING, DRYING & POLISHING



## BikeBrite

### Ride Hard. Clean Easy.

#### MOTO KIT®

The ultimate detailing kit for your motorcycle. Contains 6 of your favorite Bike Brite Products. Great for holiday gifts and special occasions.

Contains:

- Spray Wash
- Plexi-Brite®
- Moto Glaze®
- Moto Black®
- Bike Dry™ Chamois
- Bike Dry™ Jumbo Polishing Towels

| DESCRIPTION | QTY/CS | PART # | MFG #   |       |   |
|-------------|--------|--------|---------|-------|---|
| Moto Kit    | 3      | 962003 | MC10000 | 45.95 | E |

#### BIKE DRY™ MICRO FIBER

The ultimate cleaning and drying cloth. With over 90,000 fibers per square inch, the Bike Dry™ Micro-fiber cloth cleans without chemicals and absorbs over 8 times it's weight in water! It's washable and reusable, won't scratch paint and leaves a streak-free finish.

| DESCRIPTION        | QTY/CS | PART # | MFG #   |      |   |
|--------------------|--------|--------|---------|------|---|
| 1 Towel, 14" x 14" | 4      | 962017 | MC59000 | 6.95 | D |



#### MOTO GLAZE®

Moto Glaze® is the ultimate protectant against ultra-violet sun rays, humidity, boiling hot sun, freezing, salt and grime. Moto Glaze® cannot be impregnated. Guards against acid rain. Moto Glaze® is heat resistant and protects your glazed surfaces that are in close proximity of hot engine parts. Oxidation, exhaust and road film easily removed. Can be used on all clear coats and on chrome.

| DESCRIPTION      | QTY/CS | PART # | MFG #   |      |   |
|------------------|--------|--------|---------|------|---|
| Moto Glaze, 8 oz | 6      | 962019 | MC79000 | 7.95 | B |

#### BIKE DRY™ CHAMOIS

Professional grade ultra absorbent chamois material. Easily stored in bag. Great for drying windshields, face shields and bike seats. Great for personal care: hair and body drying.

| DESCRIPTION                 | QTY/CS | PART # | MFG #   |      |   |
|-----------------------------|--------|--------|---------|------|---|
| Drying Cloth, 4 Square Feet | 4      | 962020 | MC89000 | 9.95 | H |



#### JUMBO POLISHING TOWELS

3 100% cotton diaper fabric with ultra foam. 3 - 11" x 8" double sided sewed towels. Great for polishing and detailing. Great for applying wax coatings, gel coats and polishes. Great for drying your motorcycles after washing.

| DESCRIPTION               | QTY/CS | PART # | MFG #   |      |   |
|---------------------------|--------|--------|---------|------|---|
| Ultra Foam Towels, 3 Pack | 4      | 962021 | MC10000 | 8.95 | G |



# BikeBrite

Ride Hard. Clean Easy.

## MOTO MASK® ON

Moto Mask® On is a temporary transportation coating that protects your bike while touring or hauling your bike in an open trailer. Moto Mask® protects fairings, fork tubes, mirrors and fenders. Transparent protection from road debris, bugs and road grime. Bugs and road debris can be easily removed while protected from Moto Mask®. If you live in a sea town, Moto Mask® can be used to protect nuts and bolts from pitting and rust. Can be used on paint, aluminum, chrome, and plastic.

## MOTO MASK® OFF

Moto Mask® Off effectively removes Moto Mask® On. Leaves no residue. Can be buffed to a high shine. Also can be used as a quick detailer. Safe and Non-toxic.



| DESCRIPTION                  | QTY/CS | PART # | MFG #    |      |   |
|------------------------------|--------|--------|----------|------|---|
| Moto Mask On, 6.5 oz Aerosol | 12     | 962022 | MM500-12 | 9.95 | G |
| Moto Mask Off, 16 oz         | 12     | 962023 | MM510-12 | 9.95 | G |
| 12 Pack P.O.P. Display       | N/A    | 962024 | MM512D   | 9.95 | G |



## MOTO MASK® FOR WINDSCREENS

Moto Mask® for windscreens is specially formulated for motorcycles. Moto Mask® for windscreens makes beads of water disappear, helps improve vision in rain, drizzle or under misting conditions. Excellent for touring bikes. Safe on windshields made of Plexiglas®, Lexan®, polycarbonates, or acrylics.

| DESCRIPTION                     | QTY/CS | PART # | MFG #    |       |   |
|---------------------------------|--------|--------|----------|-------|---|
| Moto Mask For Windscreens, 4 oz | 12     | 962025 | MM600-12 | 8.95  | G |
| 6 Pack P.O.P. Display           | N/A    | 962026 | MM600D   | 53.95 | G |



## MOTO MASK® ANTI FOG COATING

Moto Mask® Anti-Fog Coating for windscreens, visors, goggles and more. Improves vision in fogging conditions. Safe to use on windshields made of Plexiglas®, Lexan®, polycarbonates, or acrylics.

| DESCRIPTION              | QTY/CS | PART # | MFG # |      |   |
|--------------------------|--------|--------|-------|------|---|
| Moto Mask Anti Fog, 4 oz | 12     | 962027 | MM700 | 8.95 | G |



## WIRE FLOOR RACK DISPLAY

66" wire floor rack display is made of sturdy steel wire construction. Includes all point-of-sale headers, shelf liners and shelf talkers, sie clip hangers and acrylic literature holder.

| DESCRIPTION | PART # | MFG #  |       |    |
|-------------|--------|--------|-------|----|
| Retail Rack | 962028 | MC44DS | 99.95 | AD |

MOTO-MASK FAMILY

- accessories
- towables
- body
- controls
- electrical
- driveline
- engine
- fuel & intake
- chemicals
- tie downs
- tools
- towing & loading

MARINE

- accessories
- towables
- body
- controls
- electrical
- driveline
- engine
- fuel & intake
- chemicals
- tie downs
- tools
- towing & loading



## PERMATEX

### ELIMINATOR II® ENGINE DEGREASER

Quickly dissolves and removes grease, oil and dirt from all types of equipment. Cleans iron, steel, aluminum, magnesium and copper. Not harmful to metal, rubber, plastic, or concrete. Rinses off easily with water. Suggested applications: engines, garage floors, tools, machinery. Sold each.

| DESCRIPTION       | QTY/CS | PART #  | MFG # |      |   |
|-------------------|--------|---------|-------|------|---|
| 15 oz Aerosol Can | 12     | AG80043 | 80043 | 6.95 | G |



### CHAIN LUBE

Cleans, lubricates, extends life and protects all types of roller chains, gears and cables that operate under exposed conditions. Easy-to-apply foaming action assures effective application. Repels dirt, sand, dust. Minimal "throw - off". Contains no ODC's. Suggested Applications: Ideal for any chain-driven tool or vehicle such as motorcycles, mopeds, chain saws, lawn mowers and bicycles. Sold each.

| DESCRIPTION      | QTY/CS | PART #  | MFG # |      |   |
|------------------|--------|---------|-------|------|---|
| 5 oz Aerosol Can | 12     | AG80075 | 80075 | 4.95 | G |



### BATTERY CLEANER

Spray it on and wash corrosion off. Works in just three minutes. Suggested applications: automotive, marine, farm machinery and motorcycle batteries. Sold each.

| DESCRIPTION         | QTY/CS | PART #  | MFG # |      |   |
|---------------------|--------|---------|-------|------|---|
| 5.75 oz Aerosol Can | 12     | AG80369 | 80369 | 4.95 | G |



### WHITE LITHIUM GREASE

All-purpose white lubricant for metal-to-metal and metal-to-plastic applications. Protects against rust and makes surfaces friction-free. Stainless and nontoxic. Contains no ODCs. Withstands moisture and high heat. Suggested applications: door hinges, hood latches, trunk latches, hatchback struts, seat tracks, garage door and delivery truck door tracks. Sold each.

| DESCRIPTION          | QTY/CS | PART #  | MFG # |      |   |
|----------------------|--------|---------|-------|------|---|
| 10.75 oz Aerosol Can | 12     | AG81981 | 81981 | 7.95 | G |



### PRO-STRENGTH BRAKE & PARTS CLEANER

Aggressively penetrates, dissolves, and removes oil, grease, and brake fluid. Dries fast with no residue. Developed for brake professionals. Contains no ODCs. Suggested applications: all brake systems, C.V. joints, machinery, tools, farm equipment. Sold each.

| DESCRIPTION       | QTY/CS | PART #  | MFG # |      |   |
|-------------------|--------|---------|-------|------|---|
| 19 oz Aerosol Can | 12     | AG82606 | 82606 | 5.95 | G |





## PERMATEX HAND CLEANERS

### PERMATEX FAST ORANGE PUMICE AND SMOOTH LOTION HAND CLEANER

The #1 selling, biodegradable, waterless, petroleum solvent-free hand cleaner that contains no harsh chemicals, petroleum solvents or ammonia that can sting cuts or abrasions. Pure, fresh-smelling natural citrus power does the cleaning. Fortified with aloe, lanolin, glycerin, and other skin conditioners to soothe raw, rough hands. Fine Pumice deep cleans the toughest dirt. Works great on laundry stains (smooth lotion only), scuff marks, tile floors, pet odors and many other household cleaning needs. \* Readily Biodegradable according to OECD Method 301E . Sold each.



#### PUMICE LOTION

| DESCRIPTION            | QTY/CS | PART #  | MFG # |         |
|------------------------|--------|---------|-------|---------|
| 7.5 Fluid oz Bottle    | 12     | AG25108 | 25108 | 3.95 G  |
| 1 Gallon Bottle w/Pump | 4      | AG25218 | 25219 | 22.95 G |

#### SMOOTH LOTION

| DESCRIPTION            | QTY/CS | PART #  | MFG # |         |
|------------------------|--------|---------|-------|---------|
| 7.5 Fluid oz Bottle    | 12     | AG23108 | 23108 | 3.95 G  |
| 1 Gallon Bottle w/Pump | 4      | AG23218 | 23218 | 23.95 G |

### PERMATEX FAST ORANGE PUMICE BAR HAND SOAP



Fast Orange® Pumice Bar Hand Soap is a new way to clean everyday soils from hands. The large, 5.75 oz soap bar contains fine pumice for thorough cleaning and leaves hands feeling soft. Ideally suited for the cleaning needs of automotive technicians. Suggested Applications: Removes, oil, grease, grime, paint and other everyday soils. Sold each.

| DESCRIPTION | PART #  | MFG # |        |
|-------------|---------|-------|--------|
| 5.75 oz Bar | AG25575 | 25575 | 3.95 B |

### PERMATEX DISPOSABLE NITRILE GLOVES



Permatex Nitrile Disposable Gloves are made from a 100% synthetic rubber that provides superior resistance to a wide range of solvents and hazardous chemicals. Suitable for users with natural rubber latex sensitivity. They are fully textured to provide a secure grip on dirty parts and tools. Gloves are lightly powdered, which makes them easier to put on and take off. When superior chemical resistance is required, Nitrile Disposable Gloves provide users with ideal heavy-duty hand protection.

| DESCRIPTION            | PART #  | MFG # |         |
|------------------------|---------|-------|---------|
| Large, 100 Count Box   | AG09185 | 09185 | 21.95 G |
| X-Large, 100 Count Box | AG09186 | 09186 | 21.95 G |



### SPI DISPOSABLE NITRILE GLOVES

- 100 count box
- Powdered blue

| DESCRIPTION            | PART # | MFG #      |         |
|------------------------|--------|------------|---------|
| Small, 100 Count Box   | 62274  | IN-12274   | 18.95 L |
| Medium, 100 Count Box  | 62275  | IN-12275   | 18.95 L |
| Large, 100 Count Box   | 62276  | UP-12066-3 | 17.95 L |
| X-Large, 100 Count Box | 62277  | UP-12066-4 | 17.95 L |

accessories

towables

body

controls

electrical

driveline

engine

fuel & intake

chemicals

tie downs

tools

towing & loading

MARINE



## PERMATEX

### PERMATEX MEDIUM STRENGTH THREADLOCKER BLUE GEL (GEL TWIST APPLICATOR)

OEM specified. Gel formula provides "liquid-reliability" without drips, globs, mess or waste. The GEL TWIST™ pin-point applicator puts the Threadlocker right where you want it...on the part! All-purpose, medium strength threadlocker. Ideal for all nut and bolt applications 1/4" to 3/4" (6mm to 20mm). Eliminates need for stocking expensive lock nuts and lock washers. Locks and seals while preventing parts loosening due to vibration. Protects threads from corrosion. Removable with hand tools for easy disassembly. Conforms to ASTM D 5363 AN0321 (Mil-S-46163A, Type II, Grade N).

| DESCRIPTION                      | PART #         | MFG # |         |
|----------------------------------|----------------|-------|---------|
| 10g Gel Twist Applicator, Carded | <b>AG24010</b> | 24010 | 17.95 G |

### PERMATEX HIGH STRENGTH THREADLOCKER RED GEL (GEL TWIST APPLICATOR)

OEM specified. Gel formula provides "liquid-reliability" without drips, globs, mess or waste. The GEL TWIST™ pin-point applicator puts the Threadlocker right where you want it...on the part! High strength threadlocker for heavy-duty applications 3/8 inch to 1 inch (10mm to 25mm). Especially well-suited for permanently locking studs and press fits. Adds 3,000 PSI holding power on slip and press fit assemblies. Replaces set screws and snap rings. Locks against vibration loosening. May require heat or special tools for removal. Conforms to ASTM D5363 AN0221 (Mil-S-46163A, Type I, Grade K).

| DESCRIPTION                      | PART #         | MFG # |         |
|----------------------------------|----------------|-------|---------|
| 10g Gel Twist Applicator, Carded | <b>AG27010</b> | 27010 | 17.95 G |



### THE GEL TWIST ADVANTAGE

GEL Twist Threadlocker will not drip or run like traditional liquid threadlockers and is easily portable. Threadlocker Gel stays on the part which reduces waste and makes it great for use in vertical applications. The extended nozzle allows for easy application on "hard to reach" locations.



### PERMATEX ULTRA-BLACK GASKET MAKER SEALS EXHAUST JOINTS

OEM specified. For dealership warranty requirements, Ultra Black® ensures extended drivetrain warranty compliance. Fast-curing formula. Sensor-safe, low odor, noncorrosive. Meets performance specs of OE silicone gaskets. Retains high flexibility, oil resistant properties through use of a patented adhesion system. Temperature range -65° F to 500° F (-54° C to 260° C) intermittent; resists auto and shop fluids and vibration.

| DESCRIPTION          | PART #         | MFG # |        |
|----------------------|----------------|-------|--------|
| 3.35 oz Tube, Carded | <b>AG82180</b> | 82180 | 7.95 G |

### PERMATEX ULTRA-BLUE RTV SILICONE GASKET MAKER

OEM specified. Designed specially for high-torque and high vibration applications, like those common in import engines, this premium RTV gasket maker exceeds manufacturers' performance requirements. Sensorsafe, low odor, and noncorrosive. Maximum vibration resistance, with outstanding resistance to oils, cooling and shop fluids. Guaranteed not to leak. Temperature range -65° F to 500° F (-54° C to 260° C) intermittent.

| DESCRIPTION          | PART #         | MFG # |        |
|----------------------|----------------|-------|--------|
| 3.35 oz Tube, Carded | <b>AG81724</b> | 81724 | 7.95 G |



### PERMATEX ANTI-SEIZE LUBRICANT

A highly refined blend of aluminum, copper and graphite lubricants. Use during assembly to prevent galling, corrosion and seizing due to weathering or chemicals. Anti-Seize assures easier disassembly. Temperature range: -60° F to 1600° F (-51° C to 871° C). Salt, corrosion and moisture resistant – ideal for marine use.

| DESCRIPTION           | PART #         | MFG # |        |
|-----------------------|----------------|-------|--------|
| 1 oz Tube, Carded     | <b>AG81343</b> | 81343 | 4.95 G |
| 4 oz Brush Top Bottle | <b>AG80071</b> | 80071 | 7.95 G |

### PERMATEX NON-CHLORINATED BRAKE & PARTS CLEANER

Penetrates, dissolves and removes dirt and oil from brake systems and metal parts. Safer for aluminum. Leaves no contaminant-attracting residue or chlorinated solvent run-off. Helps manage EPA halide limits. \*NFPA Fire Code 30B.

| DESCRIPTION       | PART #         | MFG # |        |
|-------------------|----------------|-------|--------|
| 20 oz Aerosol Can | <b>AG82220</b> | 82220 | 5.95 G |



- accessories
- towables
- body
- controls
- electrical
- driveline
- engine
- fuel & intake
- chemicals
- tie downs
- tools
- towing & loading

MARINE



LUBRIMATIC



LEVER ACTION GREASE GUN

Three way loading. Heavy duty performance. Uses 14 oz. cartridge. Zinc plated.

| DESCRIPTION             | PART #  | MFG #  |         |
|-------------------------|---------|--------|---------|
| Lever Action Grease Gun | LB11155 | 30-465 | 28.95 G |

LOW-TEMP MULTI PURPOSE LITHIUM GREASE

Powerful, professional-grade UltraLube instantly penetrates creating long-lasting bonds to metal and even plastic parts. Base oil is derived from vegetables - a renewable resource. Contains no zinc or chlorine and no harsh odors. Neutral in water. Biodegradable. Safer for you, your family and the environment.

| DESCRIPTION     | PART #  | MFG # |        |
|-----------------|---------|-------|--------|
| 14 oz Cartridge | LB10373 | 10373 | 8.95 G |



MARINE CORROSION CONTROL & TRAILER BEARING GREASE

Special calcium sulfonate complex, water insoluble formula ideal for marine applications. Provides excellent corrosion protection under severe conditions caused by salt water and air. Use on wheel bearings (including disc brake wheel bearings), swivel hinges, pins, winches and anchor chain reels.

| DESCRIPTION         | QTY/CS | PART #  | MFG # |         |
|---------------------|--------|---------|-------|---------|
| 1 lb Resealable Tub | 12     | LB11404 | 11404 | 11.60 G |
| 14 oz Cartridge     | 10     | LB11402 | 11402 | 9.40 G  |



WHITE LITHIUM GREASE

Includes zinc additives for a clean, white color. Ideal for general home, shop, marine, snowmobile and industrial applications. Contains no silicons and can be used on plastic components.

| DESCRIPTION         | QTY/CS | PART #  | MFG # |        |
|---------------------|--------|---------|-------|--------|
| 1 lb Resealable Tub | 12     | LB11350 | 11350 | 8.40 G |
| 14 oz Cartridge     | 10     | LB11354 | 11354 | 8.40 G |



MIDGET GREASE GUN KIT

Small, versatile gun allows for front or top pipe placement. Barrel takes 3 oz. grease cartridge or can be suction loaded. Includes push lock plunger, die cast T-handle that locks in place for loading, lock plunger, die cast T-handle that locks in place for loading, 5-1/2" straight grease pipe, standard-duty coupler and 3 oz. cartridge of LubriMatic grease. Develops up to 4,500 psi. With LubriMatic Multi-Purpose Lithium Grease.

| DESCRIPTION           | PART # | MFG #  |         |
|-----------------------|--------|--------|---------|
| Midget Grease Gun Kit | 1727   | 30-192 | 22.15 G |



MULTIPURPOSE LITHIUM GREASE 3 OZ. CARTRIDGES

Long lasting, hard working formula delivers high performance in a wide range of heavy-duty applications. Recommended for chassis, universal joints and other general purpose applications around the home, farm or shop. Works best for lubricating rolling parts. 4 pack of 3 oz cartridges.

| DESCRIPTION  | PART # | MFG # |         |
|--------------|--------|-------|---------|
| Package of 4 | 1728   | 11300 | 14.80 G |



- accessories
- towables
- body
- controls
- electrical
- driveline
- engine
- fuel & intake
- chemicals
- tie downs
- tools
- towing & loading

MARINE



## LUBRIMATIC

- accessories
- towables
- body
- controls
- electrical
- driveline
- engine
- fuel & intake
- chemicals**
- tie downs
- tools
- towing & loading

### 12" FLEXIBLE HOSE

For use on hand operated grease guns only. Steel 1/8" NPT male fittings on each end. Recommended working pressure is 5,000 PSI. Sold each.

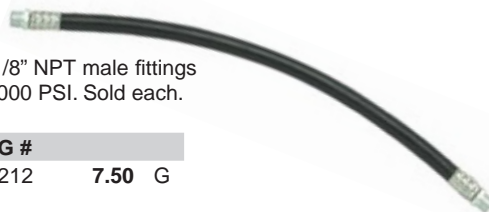

| DESCRIPTION       | PART #  | MFG #  |        |
|-------------------|---------|--------|--------|
| 12" Flexible Hose | LB11825 | 10-212 | 7.50 G |



### WHITE LITHIUM GREASE

A quality white lithium grease with exceptional consistency. Perfect for all engine rebuilding, metal-to-metal and electrical connection applications. Sold each.

| DESCRIPTION | QTY/CS | PART #  | MFG # |        |
|-------------|--------|---------|-------|--------|
| 10 oz Tube  | 12     | LB11395 | 11395 | 7.80 G |

### ELECTRICAL CONTACT GREASE

Electrical Contact Grease is a state-of-the-art product which is characterized by exceptional mechanical stability. The very high load carrying ability, excellent resistance to water, oxidation and corrosion, and outstanding performance in a wide temperature range, make it a high performance premium grease. It contains no heavy metals or other harmful or environmentally undesirable additives, such as phosphorus, chlorine, zinc, phenols, antimony, barium or lead. Sold each.

| DESCRIPTION | QTY/CS | PART #  | MFG # |        |
|-------------|--------|---------|-------|--------|
| 2 oz Tube   | 12     | LB11755 | 11755 | 8.90 G |



### FLUID QUART PUMP

Ideal for adding oil and other fluids to small engines and marine lower units. Flexible hose for hard-to-reach fill plugs. Quart sized. 4 cc pump.

| DESCRIPTION               | PART #  | MFG #  |        |
|---------------------------|---------|--------|--------|
| Pump, Sold Each, Packaged | LB11244 | 55-001 | 7.15 G |

### HIGH-VISCOSITY 80W/90 GEAR LUBE

Ideal for modern outboard and stern drive lower units. Meets or exceeds API-MT-1 and GL-5 ratings. Will not void manufacturer's warranties. Sold each.

| DESCRIPTION | QTY/CS | PART #  | MFG # |         |
|-------------|--------|---------|-------|---------|
| 1 Quart     | 12     | LB11552 | 11552 | 14.80 G |



### STORAGE FOGGING OIL

Protects internal components of 2- and 4-cycle engines from rust, corrosion or seizing during seasonal storage. Displaces moisture on all electrical motors, wet engines and equipment. Frees and loosens rusted nuts, bolts and parts in a super penetrating action. Lubricates and silences irritating squeaks. Cleans and protects metal surfaces. Sold each.

| DESCRIPTION | QTY/CS | PART #  | MFG # |         |
|-------------|--------|---------|-------|---------|
| 9.75 oz Can | 12     | LB11412 | 11412 | 14.95 G |



### PRO GREASE GUN

- Professional quality heavy duty construction and chrome plated finish for long service life
- Short stroke "lever action" for easy use in tight spaces
- Vented zinc die cast head cap
- Positive lock for easy filling
- Air bleeder valve eliminates air lock
- Knurled thick wall barrel for secure grip
- Comfort grip lever handle
- Uses standard 14 oz grease cartridge



| DESCRIPTION | PART # | MFG #  |       |   |
|-------------|--------|--------|-------|---|
| Grease Gun  | W54202 | W54202 | 17.95 | G |

### PRO PISTOL GRIP GREASE GUN

- Professional quality heavy duty construction and chrome plated finish for long service life
- Pistol grip action for easy use
- Vented zinc die cast head cap
- Positive lock for easy filling
- Air bleeder valve eliminates air lock
- 2 way filling: standard 14 oz grease cartridge or bulk
- Comfort grip lever handle



| DESCRIPTION | PART # | MFG #  |       |   |
|-------------|--------|--------|-------|---|
| Grease Gun  | 260066 | W54204 | 18.95 | G |

### MINI GREASE GUN WITH GREASE

- Heavy duty construction
- "Pistol Grip" action for easy use in tight spaces
- Vented zinc die cast head cap
- Positive lock for easy filling
- Air bleeder valve eliminates air lock
- Uses 3 oz grease cartridge (included)
- Replacement grease cartridge part # 260068



| DESCRIPTION     | PART # | MFG #  |       |   |
|-----------------|--------|--------|-------|---|
| Mini Grease Gun | 260067 | W54205 | 14.95 | G |

### 2-PACK 3 OZ MULTI PURPOSE GREASE

- Multi purpose lithium based grease is designed for light duty applications which require extended lubrication
- For light duty automotive, industrial, agricultural or commercial equipment
- Smooth consistency, water resistant and extremely stable
- Use on springs, water pumps, bearings, chassis fittings and any general lubrication projects



| DESCRIPTION               | PART # | MFG #  |      |   |
|---------------------------|--------|--------|------|---|
| 2-Pack 3 oz Multi Purpose | 260068 | W54206 | 5.95 | G |

accessories

towables

body

controls

electrical

driveline

engine

fuel & intake

chemicals

tie downs

tools

towing & loading

# MARINE

- accessories
- towables
- body
- controls
- electrical
- driveline
- engine
- fuel & intake
- chemicals**
- tie downs
- tools
- towing & loading



## ULTIMATE CORROSION PROTECTION



**NEW PRODUCT**



*Kills existing corrosion and prevents new*  
**Easy and quick to apply**  
*“ACTIVE”*  
**for up to 12 months**  
*Contains no wax, silicone, teflon or water*  
**As close to ZERO CORROSION as nature will allow**

Proven chemistry for Powersports. It will make maintenance and cleaning the bike or quad easier and save you money. It will also help prevent surface, structural and electrical corrosion related failure thereby increasing reliability and the bike's/quad's value.

### HOW IT WORKS:

ACF-50 chemically treats metal using advanced polar bonding technology. It forms a “hydrophobic” film as it removes moisture from the metal surface. When applied it forms an ‘Active’ ultra-thin clear film that will kill any existing corrosion cells and will protect your bike or quad against new corrosion forming. It contains no water and is approved for electrical switches and connectors. It will create a “water resistant” film in all these parts. ACF-50 has a strong capillary action so will creep into all the areas that moisture can; actively pushing out moisture and replacing it with protection. Use ACF-50 anywhere, except the brakes, on your bike or quad including the engine and exhaust. Safe on paintwork, most rubbers and brings up black plastic trim a treat.

**Excellent lubricant and penetrant**

**Approved for use on electronics and engines**

**Non-drying, ultra thin, clear film**

**All year round service spray**

**Very economical**

### Protects • Penetrates • Lubricates!



### ACF-50 ANTI CORROSION FORMULA

| DESCRIPTION                | SIZE                            | PART # | MFG # |               |    |
|----------------------------|---------------------------------|--------|-------|---------------|----|
| ACF-50 - Liquid            | 4 ltr / 1.06 Gal                | 650425 | 15004 | <b>118.50</b> | G  |
| ACF-50 - Aerosol           | 13 oz                           | 650426 | 15013 | <b>15.75</b>  | G  |
| ACF-50 - Liquid Spray Pump | 32 oz                           | 650427 | 15032 | <b>36.75</b>  | G  |
| ACF-50 - Liquid            | 20 ltr / 5.28 Gal               | 650428 | 15020 | <b>486.99</b> | G  |
| Hand Held Spray System     | includes 1 bullet tip / 3 wands | 650429 | 50017 | <b>525.00</b> | AD |

- Forms an “Active” ultra thin, clear film that kills existing corrosion cells, and will protect your quad or bike against new corrosion forming and last for 12 months
- “ACTIVE” which means that it ‘creeps’ and ‘keeps on working’ DOESN'T NEED REAPPLYING AFTER EVERY WASH!
- Contains no water, silicon, teflon or wax - no sticky build up, no risk of existing corrosion being sealed in and no risk of water remaining where it will cause corrosion and damage, even on electronics
- Chemically neutralizes road salt
- A clean, clear ultra thin fluid
- Dries out moisture
- Safe on all components; electronics, chrome, paint and plastic
- Use on heads, cooling fans, throttle linkages, brake cables, battery terminals, voltage regulator, suspension, engine components, torsion bars, fuel control units, fuse box, swingarm, relays / connectors, undercarriage, chain, ignition switch, security systems / FOBs and more!
- ACF-50 can be sprayed on, wiped on with a rag, or professionally fogged for complete protection





- accessories
- towables
- body
- controls
- electrical
- driveline
- engine
- fuel & intake
- chemicals
- tie downs
- tools
- towing & loading

MARINE

# CORROSION BLOCK

## High Performance WATERPROOF GREASE

**NEW PRODUCT**

### CORROSION BLOCK LIQUID • AEROSOL

#### Kills Corrosion on Contact!

- Protects metal and electronics during play and storage
- Chemically neutralizes salt water
- A clean, clear ultra-thin fluid which leaves a non greasy atmospheric barrier to protect all metal surfaces
- Leaves no gummy residue because it does not contain wax, resin, tar, asphalt, silicone or Teflon
- Can be sprayed, brushed or wiped on
- Hydrophobic film provides corrosion protection all season
- Protects metal components down to -70°
- Keeps ice and mud from sticking
- Combined with its excellent penetrating and strong dielectric properties (40Kv), have brought electronics "back from the dead"
- Removes moisture from the corrosion by-product and isolates it from contacting the metal surface, restoring continuity to electrical circuits
- Can be used in many different electrical and electronic applications without fear of damaging the conformal coatings used
- Does not harm plastics or painted surfaces
- Improves reliability, reduces repair and labor cost

### CORROSION BLOCK WATERPROOF GREASE

- Out performs lithium and most synthetic greases and meets or exceeds requirements for NGLI Service Classifications GC-LB (automotive wheel bearing and chassis lubricants) conforming to ATM D4950 performance requirements
- Excellent extreme pressure properties
- Excellent thermal / oxidative stability
- Resists bleeding / melting at high temperatures
- Suitable for sealed for life applications
- Dielectric / non-conductive
- Workplace safe and environmentally friendly
- Out performs competitive grease 5:1
- Waterproof

### Prevention is better than replacement!

*Corrosion Block is a unique product that has the ability to both prevent and stop corrosion in more places on Powersports Equipment than any other product of its type.*

**Corrosion Block is superior anti-corrosion compound. It kills corrosion in progress, prevents new corrosion cells from forming for 12-18 months, is an excellent penetrant and is an excellent light lubricant.**



| DESCRIPTION               | SIZE                | PART # | MFG # |        |    |
|---------------------------|---------------------|--------|-------|--------|----|
| Corrosion Block - Liquid  | 4 ltr / 1.06 Gal    | 650417 | 20004 | 112.95 | G  |
| Corrosion Block - Aerosol | 12 oz               | 650418 | 20012 | 14.65  | B  |
| Corrosion Block - Liquid  | 32 oz               | 650419 | 20032 | 34.95  | D  |
| Corrosion Block - Liquid  | 20 liter / 5.28 Gal | 650420 | 20020 | 430.00 | B  |
| Corrosion Block Grease    | 2 oz Tube           | 650421 | 25002 | 5.25   | G  |
| Corrosion Block Grease    | 3 oz Cartridge      | 650422 | 25003 | 7.85   | AE |
| Corrosion Block Grease    | 14 oz Cartridge     | 650423 | 25014 | 9.95   | B  |
| Corrosion Block Grease    | 16 oz Tub           | 650424 | 25016 | 11.05  | G  |

## BIKE SPIRITS

- accessories
- towables
- body
- controls
- electrical
- driveline
- engine
- fuel & intake
- chemicals
- tie downs
- tools
- towing & loading

MARINE

### SPRAY CLEANER & POLISH

**Quickly Cleans, Polishes & Protects**

- "Roadside Detailer" Cleans Road Grime, Grease & Bugs Without Water
- Polishes Paint & Chrome
- Repels Water
- Anti-Static Properties
- Reduce Dust Buildup
- 50-State VOC Compliant



| DESCRIPTION      | QTY/CS | PART # | MFG #   |      |   |
|------------------|--------|--------|---------|------|---|
| 14 oz, Sold Each | 12     | 650621 | 1036420 | 7.50 | G |
| 5 oz, Sold Each  | 12     | 650622 | 1039696 | 5.70 | G |

### CONTACT BRAKE CLEANER

**Quick-Drying Solvent Leaves No Residue**

- Non-Chlorinated
- Removes Grease, Oil, Road Grime, Brake Fluid & Chain Lube Overspray
- Instant Evaporation
- OTC/LADCO VOC Compliant



| DESCRIPTION      | QTY/CS | PART # | MFG #   |      |   |
|------------------|--------|--------|---------|------|---|
| 14 oz, Sold Each | 12     | 650623 | 1037677 | 6.50 | G |

### CHAIN LUBE

**The Ultimate in Lubrication & Protection**

- Contains P.T.F.E. & Moly for Superior Lubrication
- Dries Fast; No Sling-Off Formula
- Dye less Formula Won't Stain White Paint
- Repels Dirt & Water
- Superb Rust Protection
- For Use On O-Ring & Standard Chains
- 50-State VOC Compliant

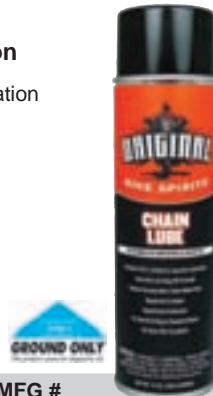

| DESCRIPTION      | QTY/CS | PART # | MFG #   |       |   |
|------------------|--------|--------|---------|-------|---|
| 13 oz, Sold Each | 12     | 650625 | 1036423 | 10.95 | G |

### CHAIN LUBE WITH WHITE GRAPHITE

**The Ultimate in Lubrication, Cleanliness & Protection**

- "White Graphite" Technology for Superior Lubricity
- Compatible With O-Ring & Conventional Chains
- Quick Drying to a White Tacky Lubricating Film
- No Sling-Off Formula
- Minimizes Attraction of Grit, Sand & Dirt
- Resists Wash-Off
- 50-State VOC Compliant

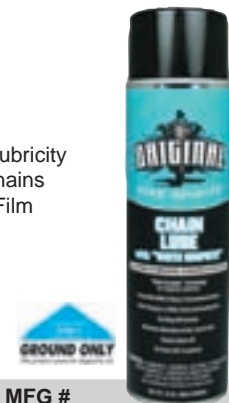

| DESCRIPTION      | QTY/CS | PART # | MFG #   |       |   |
|------------------|--------|--------|---------|-------|---|
| 13 oz, Sold Each | 12     | 650626 | 1036422 | 10.95 | G |

### CARB CLEANER

**Dissolves Carbon, Gum & Vanish**

- FOR GASOLINE ENGINES ONLY
- Cleans Carb, Choke & Throttle Bodies
- High Pressure Blast Spray
- Eliminates Stalling & Rough Idling
- Cleans Inside & Out
- 50-State VOC Compliant



| DESCRIPTION      | QTY/CS | PART # | MFG #   |      |   |
|------------------|--------|--------|---------|------|---|
| 13 oz, Sold Each | 12     | 650627 | 1037678 | 6.50 | G |

### CYCLE FUEL SYSTEM SUPREME

**Professional Strength Fuel System Cleaner**

- Fuel System & Carbon Deposit Cleaner
- Helps Reduce Emissions
- Emission System Safe
- Reduces Engine Ping & Knock
- Improves Engine Response
- For Gasoline Engines Only



| DESCRIPTION     | QTY/CS | PART # | MFG #   |      |   |
|-----------------|--------|--------|---------|------|---|
| 8 oz, Sold Each | 12     | 650628 | 1037838 | 7.95 | G |

### CYCLE WASH

**Total Cycle Wash/Degreaser**

- Easily Cleans with Little or No Scrubbing
- Cleans Entire Motorcycle in Minutes
- Removes Road Grime, Grease & Oil
- Cleans Tires & Wheels
- Leaves No Residue

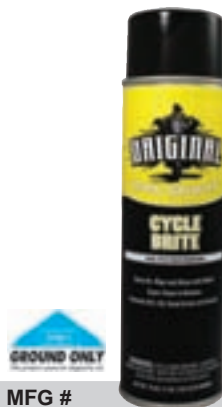

| DESCRIPTION      | QTY/CS | PART # | MFG #   |      |   |
|------------------|--------|--------|---------|------|---|
| 18 oz, Sold Each | 12     | 650629 | 1037862 | 7.95 | G |





# TIE DOWNS

- accessories
- towables
- body
- controls
- electrical
- driveline
- engine
- fuel & intake
- chemicals
- tie downs**
- tools
- towing & loading



## ANCRA TIE DOWNS



### GRADUAL RELEASE RATCHET INTEGRAS WITH INTEGRATED SOFT HOOKS

- Patented GRR buckle for controlled release
- Locking latch prevents handle from opening 600 lb. working load limit
- 1.5" abrasion resistant nylon webbing
- Vinyl coated s-hooks
- 5-1/2' overall length
- Packaged in pairs

| PART # | MFG #     | COLOR | U/M |       |   |
|--------|-----------|-------|-----|-------|---|
| 472009 | 49970-102 | BLACK | PR  | 54.25 | L |
| 472010 | 49970-112 | BLUE  | PR  | 54.25 | L |
| 472011 | 49970-122 | RED   | PR  | 64.95 | L |

### GRADUAL RELEASE RATCHET STANDARD TIE DOWNS

- Patented GRR buckle for controlled release
- Locking latch prevents handle from opening 600 lb. working load limit
- 1.5" abrasion resistant nylon webbing
- Vinyl coated s-hooks
- 5-1/2' overall length
- Packaged in pairs

| PART # | MFG #     | COLOR | U/M |       |   |
|--------|-----------|-------|-----|-------|---|
| 472006 | 49970-202 | BLACK | PR  | 49.75 | L |
| 472008 | 49970-222 | RED   | PR  | 49.75 | L |



### CAM BUCKLE INTEGRAS WITH INTEGRATED SOFT HOOKS

- 2,100 lbs. rated heavy duty cam buckle with cam plate
- 600 lb. working load limit
- 1.5" abrasion resistant nylon webbing
- Vinyl coated s-hooks
- 5-1/2' overall length
- Packaged in pairs

| PART # | MFG #     | COLOR | U/M |       |   |
|--------|-----------|-------|-----|-------|---|
| 472003 | 49494-202 | RED   | PR  | 61.95 | L |
| 472004 | 49494-212 | BLACK | PR  | 53.00 | L |
| 472005 | 49494-222 | BLUE  | PR  | 53.00 | L |



### CAM BUCKLE STANDARD TIE DOWNS

- 2,100 lbs. rated heavy duty cam buckle with cam plate
- 600 lb. working load limit
- 1.5" abrasion resistant nylon webbing
- Vinyl coated s-hooks
- 5-1/2' overall length
- Packaged in pairs

| PART # | MFG #     | COLOR | U/M |       |   |
|--------|-----------|-------|-----|-------|---|
| 472001 | 49494-112 | BLACK | PR  | 48.50 | L |



MARINE



### ORIGINAL RED TIE DOWNS

- 1" x 5-1/2'
- One inch air-craft quality nylon webbing and Ancra's patented pressure plate cam buckle
- Vinyl coated "S" hook protects chrome and paint and attaches firmly to trunk or trailer
- The Original "Red" also features a sewn hand loop for ease of cinching
- Complete tie down instructions included
- 1,200 lbs. straight tension and 2,400 lbs looped tension
- One pair per package

| PART #   | MFG #    | COLOR | U/M |       |   |
|----------|----------|-------|-----|-------|---|
| AN408810 | 40888-10 | RED   | PR  | 24.90 | L |

## ANCRA TIE DOWNS



### CLASSIC BLACK TIE DOWNS

- 1" x 5-1/2'
- Like the Original Red, this tie down has been a top seller for years
- Ancra's 'Black' strap is engineered to last with weather and abrasion resistant one inch wide nylon webbing
- It comes with vinyl coated end hooks and fasteners
- Loop end strap for a better grip
- It also has a pressure plate cam buckle
- 1,200 lbs. straight tension and 2,400 lbs looped tension
- One pair per package

| PART #   | MFG #    | COLOR | U/M |       |   |
|----------|----------|-------|-----|-------|---|
| AN408826 | 40888-26 | BLACK | PR  | 24.90 | L |

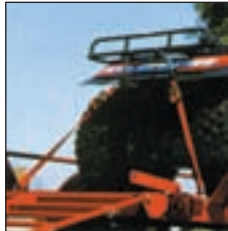

### ATV RAT PAK

- 1" x 5-1/2'
- 1" ratchet Buckle version of the Original tie down
- Webbing - 4,500 lb. tensile strength nylon
- Buckle - 4,400 lb. rated 1" ratchet buckle
- Hooks - 2 ea. 1,200 lb. rated vinyl "S" hooks (1 vinyl coated, 1 plated) per strap
- Working load capacity - 400 lb. per strap
- Minimum assembly strength - 1,200 lb. per strap
- Packaged in pairs

| PART #   | MFG #    | COLOR | U/M |       |   |
|----------|----------|-------|-----|-------|---|
| AN473910 | 47439-10 | RED   | PR  | 33.00 | L |

### ATV QUAD PAK

- 1" x 5-1/2'
- 4 pack of Ancra's Original Reds and Rat Pak for securing larger motorcycles and atvs
- Webbing - 4,500 lb. tensile strength nylon
- Buckle - 4,400 lb. rated 1" ratchet buckle and 1,800 lb. rated cam buckle with pressure plate
- Hooks - 2 ea. 1,200 lb. rated vinyl coated hooks on each original red and 1 ea. vinyl coated hook and 1 ea. plated hook on each rat pak strap
- Overall length length - 66"
- Minimum assembly strength - 1,200 lb. per strap
- Working load capacity - 400 lb. per strap
- Packaged in 4 strap sets of 2 each
- 1,200 lbs. straight tension and 2,400 lbs looped tension

| PART #   | MFG #    | COLOR | U/M |       |   |
|----------|----------|-------|-----|-------|---|
| AN452110 | 45211-10 | RED   | PR  | 54.50 | L |



### 12" SOFT HOOK EXTENSIONS

- Ancra's soft-hook offers the best protection when transporting
- The one inch black nylon webbing acts as a tie down extension or loops around the handlebars or rear seat rails, eliminating hard contact of steel hooks
- Assembly strength of each soft hook is 3,000 lbs.
- Packaged in pairs

| PART #   | MFG #    | COLOR | U/M |      |   |
|----------|----------|-------|-----|------|---|
| AN459211 | 45214-14 | BLACK | PR  | 6.80 | L |

### 13' GENERAL PURPOSE RED TIE DOWN

- Longer version of the Ancra Originals
- Webbing - 4,500 lb. tensile strength nylon
- Buckle - 1,800 lb. rated heavy duty cam buckle with pressure plate
- Hooks - 2 ea. 1,200 lb. rated vinyl coated "S" hooks per strap
- Overall length - 13" with sewn hand loop
- Minimum assembly strength - 1,200 lb. per strap
- Working load capacity - 400 lb. per strap
- All components are made in the USA

| PART #   | MFG #    | COLOR | U/M |       |   |
|----------|----------|-------|-----|-------|---|
| AN408825 | 40888-25 | RED   | PR  | 25.10 | L |



- accessories
- towables
- body
- controls
- electrical
- driveline
- engine
- fuel & intake
- chemicals
- tie downs**
- tools
- towing & loading

MARINE

## ERICKSON TIE DOWNS



- accessories
- towables
- body
- controls
- electrical
- driveline
- engine
- fuel & intake
- chemicals
- tie downs**
- tools
- towing & loading



### RETRACTABLE RATCHETING TIE DOWN STRAPS

- (2 ea.) 1" x 6' - 1,500#
- Work load limit 500#
- Simple to operate. Just pull web out to the desired length and start ratcheting until tight. To release, push down on red release button
- Display packaged
- Black

| PART #  | MFG # | COLOR | U/M |       |   |
|---------|-------|-------|-----|-------|---|
| EK34413 | 34413 | BLACK | PR  | 28.70 | G |

### RETRACTABLE RATCHETING TIE DOWN STRAPS

- (2 ea.) 2" x 6' - 4,000#
- Work load limit 1,333#
- Simple to operate. Just pull web out to the desired length and start ratcheting until tight. To release, push down on red release button
- Display packaged
- Black

| PART #  | MFG # | COLOR | U/M |       |   |
|---------|-------|-------|-----|-------|---|
| EK34414 | 34414 | BLACK | PR  | 51.30 | G |



### RE-TRACTABLE TIE-DOWN STRAPS

Erickson's new patented design is the next step up in the Tie-Down industry. The Re-Tractables are so simple to operate – simply pull the web out to the desired length and start ratcheting until tight. To release, simply push down on the RED release button. The web not being used is stored in the center housing so you have no web blowing in the wind. This feature also keeps the straps clean and Free from oil and dirt. Our interactive packaging design lets the customer operate the Re-Tractable ratchet right in the dealer's store. The self-sell feature saves a lot of wasted dealer selling time.

| PART # | MFG # | COLOR | U/M |       |   |
|--------|-------|-------|-----|-------|---|
| 266015 | 34415 | BLACK | PR  | 30.95 | G |
| 266016 | 54415 | BLACK | EA  | 16.95 | G |

### ATV TIE DOWN STRAPS

- (3 ea.) 1" x 5' - 750#
- Maximum load is an actual lift load, all straps are tested in this method and rated 25% less than the actual break point
- The weakest point in most cases is the hook
- Each set has 1" x 5' nylon webbing and 3/8" 90° vinyl coated hooks
- Maximum load of 700#
- Display packaged
- Red

| PART #  | MFG # | COLOR | U/M      |       |   |
|---------|-------|-------|----------|-------|---|
| EK06300 | 06300 | RED   | SET OF 3 | 19.95 | G |





## ERICKSON TIE DOWNS



### CAM BUCKLE TIE DOWNS

- (4 ea.) 1" x 5 1/2' - 900#
- Quick lock cam buckles
- Heat treated vinyl coated hooks

| PART # | MFG # | COLOR | U/M              |
|--------|-------|-------|------------------|
| EK5605 | 05605 | RED   | SET OF 4 22.35 G |



### STAINLESS STEEL RATCHETING TIE DOWNS

- (4 ea.) 1" x 6' - 1,200#
- Stainless steel ratchet
- Black

| PART # | MFG # | COLOR | U/M              |
|--------|-------|-------|------------------|
| 266000 | 05515 | BLACK | SET OF 4 55.95 G |



### CAM LOCK TIE DOWNS

- (2 ea.) 1" x 6' - 1,200#
- Features the traditional pull and lock cam buckles
- Blue

| PART #  | MFG # | COLOR | U/M              |
|---------|-------|-------|------------------|
| EK34403 | 34403 | BLUE  | PR 13.20 G       |
| 266014  | 35605 | BLUE  | SET OF 4 24.95 G |



### RATCHETING TIE DOWNS

- 1" x 6' ratchet straps
- 1,200 lb. maximum load capacity
- Black
- 4-pack

| PART #  | MFG # | COLOR                 | U/M              |
|---------|-------|-----------------------|------------------|
| EK05511 | 05511 | BLACK WITH RED TRACER | SET OF 4 30.30 G |



### RE-TRACTABLE TIE DOWN STRAP

Erickson's new patented design is the next step up in the Tie-Down industry. The Re-Tractables are so simple to operate – simply pull the web out to the desired length and start ratcheting until tight. To release, simply push down on the RED release button. The web not being used is stored in the centre housing so you have no web blowing in the wind. This feature also keeps the straps clean and Free from oil and dirt. Our interactive packaging design lets the customer operate the Re-Tractable ratchet right in the dealer's store. The self-sell feature saves a lot of wasted dealer selling time. (4 ea.) 1" x 6' - 1,500#. Re-tractable ratchet. Black.

| PART # | MFG # | COLOR | U/M              |
|--------|-------|-------|------------------|
| 266043 | 34420 | BLACK | SET OF 4 50.95 G |



- accessories
- towables
- body
- controls
- electrical
- driveline
- engine
- fuel & intake
- chemicals
- tie downs**
- tools
- towing & loading

MARINE

## ERICKSON TIE DOWNS



- accessories
- towables
- body
- controls
- electrical
- driveline
- engine
- fuel & intake
- chemicals
- tie downs
- tools
- towing & loading



### DELUXE RUBBER HANDLE RATCHETING TIE-DOWNS

- (4 ea.) 1" x 6' - 2,000#
- Deluxe rubber handle ratchet
- Red

| PART # | MFG # | COLOR | U/M              |
|--------|-------|-------|------------------|
| 266005 | 05519 | RED   | SET OF 4 44.95 G |

### SPORTSMAN ATV KITS

- (4 ea.) 1" x 6' - 2,000#
- Ratchet strap
- Blue

| PART # | MFG # | COLOR | U/M              |
|--------|-------|-------|------------------|
| 266006 | 05513 | BLUE  | SET OF 4 32.95 G |



### SPORTSMAN TIE DOWN STRAPS

- 1" x 6'
- 2,000 lb. rated
- TCS buckle straps
- Over center lock buckle has no teeth to damage the web
- Simply attach your hooks and pull loose ends through the buckle, flip handle down and lock into safety tab
- Hunter orange
- 4-pack

| PART # | MFG # | COLOR         | U/M              |
|--------|-------|---------------|------------------|
| 266001 | 05740 | HUNTER ORANGE | SET OF 4 27.95 G |

### RATCHETING TIE DOWN WITH WEB CLAMP

Erickson's Strap Trap holds the excess web not being used by simply clamping it into the ratchet handle so it can't blow in the wind. the clamping mechanism is much like a mouse trap, lift the spring loaded clamp and place the folded webbing under the clamp, release the strap trap and you have trapped the excess web.

| SIZE     | MAX LOAD | SAFE WORKING LOAD | QTY    | MFG #                 |
|----------|----------|-------------------|--------|-----------------------|
| 1" x 15' | 1,500#   | 500#              | 1 pack | 31351 EK31350 10.60 G |
| 1" x 8'  | 1,500#   | 500#              | 2 pack | 31352 EK31351 16.75 G |
| 1" x 15' | 1,500#   | 500#              | 4 pack | 31350 EK31352 33.10 G |



MARINE





## ERICKSON TIE DOWNS



### RATCHETING TIE DOWNS W/CAMO WEBBING

- (4 ea.) 1" x 10' - 900#
- Quick lock cam buckles
- Heat treated vinyl coated hooks

| PART # | MFG # | COLOR | U/M              |
|--------|-------|-------|------------------|
| EK1419 | 01419 | CAMO  | SET OF 4 29.80 G |



### RUBBER HANDLE RATCHETING TIE-DOWNS

- (4 ea.) 1" x 10' - 1,200#
- Heat treated vinyl coated hooks
- Fully rubberized handle and thumb release

| PART # | MFG # | COLOR | U/M              |
|--------|-------|-------|------------------|
| EK1415 | 01415 | BLUE  | SET OF 4 25.95 G |



### RATCHETING TIE-DOWN STRAPS

- (4 ea.) 1" x 10' - 900#
- Ratchet strap
- Red

| PART # | MFG # | COLOR | U/M              |
|--------|-------|-------|------------------|
| 266003 | 01418 | RED   | SET OF 4 22.95 G |



### RATCHETING TIE-DOWNS

- 1-1/4" x 12' - 2,500#
- Long handle ratchet with moulded rubber handles
- Allows ease in operation
- Strong silver polyester web

| PART # | MFG # | COLOR | U/M              |
|--------|-------|-------|------------------|
| 266012 | 34411 | GRAY  | SET OF 4 51.95 G |
| 266013 | 34412 | GRAY  | PR 26.95 G       |

### RATCHETING TIE DOWNS

- 1" x 15' - 1,200#
- Patented molded rubber handles
- Display packaged
- Blue

| PART #  | MFG # | COLOR | U/M              |
|---------|-------|-------|------------------|
| 266010  | 31415 | BLUE  | SET OF 4 30.95 G |
| EK34400 | 34400 | BLUE  | PR 15.90 G       |



- accessories
- towables
- body
- controls
- electrical
- driveline
- engine
- fuel & intake
- chemicals
- tie downs**
- tools
- towing & loading

MARINE

## ERICKSON TIE DOWNS



- accessories
- towables
- body
- controls
- electrical
- driveline
- engine
- fuel & intake
- chemicals
- tie downs**
- tools
- towing & loading



### RATCHETING TIE DOWNS

- 1" x 15' - 1,200#
- High-quality yellow chromate-plated ratchets
- Red

| PART # | MFG # | COLOR | U/M      |       |   |
|--------|-------|-------|----------|-------|---|
| 266008 | 31418 | RED   | SET OF 4 | 27.95 | G |
| 266009 | 34401 | RED   | PR       | 14.95 | G |

### RATCHETING TIE DOWNS

- 1" x 15' - 2,000#
- Wide handle molded rubber handles make tightening easy on handle
- Display packaged
- Orange

| PART #  | MFG # | COLOR  | U/M      |       |   |
|---------|-------|--------|----------|-------|---|
| EK34404 | 34404 | ORANGE | PR       | 23.90 | G |
| 266011  | 31416 | ORANGE | SET OF 4 | 44.95 | G |

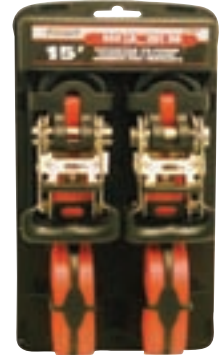

### RATCHET STRAP W/DOUBLE FLOATING RING

- 1" x 15' - 3,000#
- Ratchet strap with double floating ring
- Black

| PART # | MFG # | COLOR | U/M |       |   |
|--------|-------|-------|-----|-------|---|
| 266019 | 01314 | BLACK | EA  | 18.95 | G |

MARINE

### RATCHET STRAP

- 2" x 15' - 5,000#
- Ratchet strap
- Yellow

| PART # | MFG # | COLOR  | U/M |       |   |
|--------|-------|--------|-----|-------|---|
| EK2300 | 02300 | YELLOW | EA  | 29.20 | G |





## ERICKSON TIE DOWNS

### RATCHETING LOGISTIC STRAPS

- 2" x 20' - 3,500#
- Ratchet logistic strap, bulk
- Blue

| PART # | MFG # | COLOR | U/M |       |   |
|--------|-------|-------|-----|-------|---|
| 266026 | 59140 | BLUE  | EA  | 17.95 | G |



### AXLE STRAP

- 2" x 24" - 5,000#
- Axle strap, bulk
- Blue

| PART # | MFG # | COLOR | U/M |      |   |
|--------|-------|-------|-----|------|---|
| 266027 | 58506 | BLUE  | EA  | 4.95 | G |

### RATCHET STRAPS

- 2" x 25' - 5,000#
- Ratchet logistic strap, 1 pack
- Yellow

| PART # | MFG # | COLOR  | U/M |       |   |
|--------|-------|--------|-----|-------|---|
| EK2400 | 02400 | YELLOW | EA  | 34.75 | G |



### CAMO WEB

- Rubber handle ratchet and release with vinyl coated hooks
- 2" x 27' - 10,000#
- 3,300# working load limit
- Sold each (bulk)

| PART #  | MFG # | COLOR | U/M |       |   |
|---------|-------|-------|-----|-------|---|
| EK68655 | 68655 | CAMO  | EA  | 33.25 | G |

### ASSIST STRAPS

- 1" x 18" - 2,000#
- 2-pack

| PART # | MFG # | COLOR | U/M |      |   |
|--------|-------|-------|-----|------|---|
| 266017 | 06303 | BLACK | PR  | 3.95 | G |
| 266018 | 06304 | RED   | PR  | 3.95 | G |



|                  |
|------------------|
| accessories      |
| towables         |
| body             |
| controls         |
| electrical       |
| driveline        |
| engine           |
| fuel & intake    |
| chemicals        |
| <b>tie downs</b> |
| tools            |
| towing & loading |

MARINE

## ERICKSON TIE DOWNS



- accessories
- towables
- body
- controls
- electrical
- driveline
- engine
- fuel & intake
- chemicals
- tie downs
- tools
- towing & loading



### 12" CHROME PROTECTOR

- Fits 1" to 2" webbing
- 100% polyester/simulated sheepskin
- 1 pack

| PART # | MFG # | COLOR | U/M |      |   |
|--------|-------|-------|-----|------|---|
| 266044 | 06305 | N/A   | EA  | 4.95 | G |

### TCS BUCKLE

- 1" x 5' - 1,200#
- Security lock buckles, 3 pack
- Camo

| PART # | MFG # | COLOR | U/M      |       |   |
|--------|-------|-------|----------|-------|---|
| EK5726 | 05726 | CAMO  | SET OF 3 | 28.90 | G |



### ADJUSTABLE TIRE STRAP W/RATCHET

- 10,000#
- Adjustable tire strap, 1 pack
- Yellow

| PART #  | MFG # | COLOR  | U/M |       |   |
|---------|-------|--------|-----|-------|---|
| EK08522 | 08522 | YELLOW | EA  | 46.60 | G |

MARINE

### COMBO PACK

- (2) 1" x 10' - 1,200# ratchets
- (2) 1" x 6' - 900# cam straps
- 4 pack
- Blue and red

| PART # | MFG # | COLOR     | U/M      |       |   |
|--------|-------|-----------|----------|-------|---|
| 266002 | 05606 | RED, BLUE | SET OF 4 | 24.95 | G |





## ERICKSON TIE DOWNS



### 16-PIECE STRAP PACK

- (2) 1" x 15' - 500 lb. Rubber Handle Ratchet Straps
- (1) 1" x 10' - 300 lb. Cam Strap
- (1) 1" x 10' Utility Strap
- (2) 1" x 6' Handy Straps
- Deluxe Bungee Cords 2 ea. 18", 24", 36"
- (4) Mini Bungee Cords

| PART # | MFG # | COLOR | U/M |       |   |
|--------|-------|-------|-----|-------|---|
| 266004 | 03000 | N/A   | EA  | 32.95 | G |



### STRAP HANGER

- Strap hanger, bulk
- Black

| PART # | MFG # | COLOR | U/M |      |   |
|--------|-------|-------|-----|------|---|
| 266007 | 58000 | BLACK | EA  | 7.95 | G |

### TOW ROPE

- 1/2" x 14' - 2,000# breaking strength, 1,000# maximum vehicle weight
- Includes storage bag

| PART # | MFG # | COLOR  | U/M |       |   |
|--------|-------|--------|-----|-------|---|
| EK9103 | 09103 | YELLOW | EA  | 13.95 | G |



### TOW ROPE

- 7/8" x 14' - 8,500# breaking strength, 4,200# maximum vehicle weight
- Includes storage bag

| PART # | MFG # | COLOR | U/M |       |   |
|--------|-------|-------|-----|-------|---|
| EK9102 | 09102 | BLUE  | EA  | 17.80 | G |

### RECOVERY STRAP

- 1" x 15' - 7,500# breaking strength, 3,750# maximum vehicle weight
- Includes storage bag

| PART # | MFG # | COLOR | U/M |       |   |
|--------|-------|-------|-----|-------|---|
| 266028 | 59350 | WHITE | EA  | 24.95 | G |



- accessories
- towables
- body
- controls
- electrical
- driveline
- engine
- fuel & intake
- chemicals
- tie downs**
- tools
- towing & loading

MARINE

## ERICKSON TIE DOWNS



- accessories
- towables
- body
- controls
- electrical
- driveline
- engine
- fuel & intake
- chemicals
- tie downs
- tools
- towing & loading



### TOW STRAP

- 2" x 15' - 8,500#
- With forged hooks and blue polyester web

| PART #  | MFG # | COLOR | U/M        |
|---------|-------|-------|------------|
| EK34405 | 34405 | BLUE  | EA 20.25 G |

### TOW STRAP WITH FORGED SAFETY SNAP HOOK

- 2" x 20' - 10,000# breaking strength, 5,000# maximum vehicle weight

| PART # | MFG # | COLOR | U/M        |
|--------|-------|-------|------------|
| 266029 | 09301 | BLUE  | EA 34.95 G |

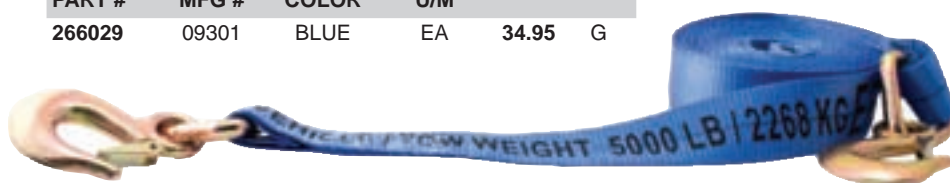

### DELUXE RUBBER HANDLE RATCHET (LONG)

- 2" x 27' - 10,000#
- Long Handle
- Deluxe Molded Rubber Handle
- Vinyl Coated Double J-Hooks
- Velcro Strap Wrapper
- 10 per Display Box
- 24 cases per Pallet

| PART #  | MFG # | COLOR  | U/M        |
|---------|-------|--------|------------|
| EK69627 | 69627 | YELLOW | EA 34.60 G |



### 10,000 LB. MINI WINCH

- 2" - 10,000#
- Sold each, bulk

| PART # | MFG # | COLOR | U/M        |
|--------|-------|-------|------------|
| 266021 | 52804 | N/A   | EA 15.95 G |

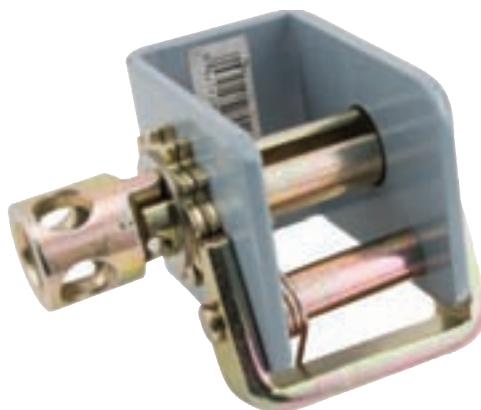



## ERICKSON TIE DOWNS

### TIGHTENING BAR

- 10"
- Sold each

| PART # | MFG # | COLOR | U/M |      |   |
|--------|-------|-------|-----|------|---|
| 266024 | 52802 | N/A   | EA  | 5.95 | G |



### WEB PROTECTOR

- Sold each, bulk

| PART # | MFG # | COLOR | U/M |      |   |
|--------|-------|-------|-----|------|---|
| 266025 | 59708 | WHITE | EA  | 2.95 | G |



### HAND WINCH STRAP

- 2" x 20' - 10,000#
- Sold each, packaged

| PART #  | MFG # | COLOR | U/M |       |   |
|---------|-------|-------|-----|-------|---|
| EK06410 | 06410 | BLUE  | EA  | 23.95 | G |



### HAND WINCH STRAP

- 2" x 25' - 3,300#
- Sold each, packaged

| PART #  | MFG # | COLOR | U/M |       |   |
|---------|-------|-------|-----|-------|---|
| EK06404 | 06404 | BLACK | EA  | 16.30 | G |

### WINCH STRAP

- 2" x 27' - 5,000#
- Sold each, packaged

| PART # | MFG # | COLOR  | U/M |       |   |
|--------|-------|--------|-----|-------|---|
| 266022 | 03100 | YELLOW | EA  | 16.95 | G |



- accessories
- towables
- body
- controls
- electrical
- driveline
- engine
- fuel & intake
- chemicals
- tie downs**
- tools
- towing & loading

MARINE

## ERICKSON TIE DOWNS



- accessories
- towables
- body
- controls
- electrical
- driveline
- engine
- fuel & intake
- chemicals
- tie downs**
- tools
- towing & loading



### WINCH STRAP WITH FLAT HOOK

- 2" x 30' - 10,000#
- Sold each, bulk

| PART # | MFG # | COLOR  | U/M |       |   |
|--------|-------|--------|-----|-------|---|
| 266023 | 58600 | YELLOW | EA  | 22.95 | G |

### STANDARD BUNGEY 2-PACK

- 2 pack

| SIZE | PART # | MFG # |      |   |  |
|------|--------|-------|------|---|--|
| 13"  | EK6645 | 06645 | 2.45 | G |  |
| 18"  | EK6646 | 06646 | 2.60 | G |  |
| 24"  | EK6647 | 06647 | 2.75 | G |  |
| 30"  | EK6648 | 06648 | 3.15 | G |  |
| 36"  | EK6649 | 06649 | 3.85 | G |  |



### 10" MINI BUNGEY 4-PACK

- 10"
- 4 pack

| PART # | MFG # | COLOR | U/M      |      |   |
|--------|-------|-------|----------|------|---|
| EK6699 | 06699 | MULTI | SET OF 4 | 1.80 | G |

### FLAT BUNGEY

A hardened metal wire form is placed in the center of the molded polycarbonate hook making it super strong.

| SIZE | PART #  | MFG # |      |   |  |
|------|---------|-------|------|---|--|
| 12"  | EK06912 | 06912 | 2.90 | G |  |
| 18"  | EK06918 | 06918 | 3.15 | G |  |
| 24"  | EK06924 | 06924 | 3.25 | G |  |
| 30"  | EK06930 | 06930 | 3.45 | G |  |
| 36"  | EK06936 | 06936 | 3.60 | G |  |
| 42"  | EK06942 | 06942 | 3.85 | G |  |



### DELUXE BUNGEY

- Talk about quality! That's what the deluxe bungee is all about
- An Industrial grade bungee comes secured to a molded polycarbonate hook with a hardened wire insert molded in
- 3 sizes available in 3 colors

| SIZE | COLOR  | PART #  | MFG # |      |   |
|------|--------|---------|-------|------|---|
| 12"  | RED    | EK07012 | 07012 | 2.55 | G |
| 24"  | BLUE   | EK07024 | 07024 | 3.10 | G |
| 36"  | YELLOW | EK07036 | 07036 | 3.55 | G |



MARINE





## ERICKSON TIE DOWNS

### 12 PACK JAR ASSORTMENT

Solid colors

- 4 - 10" x 4mm
- 2 - 18" x 8mm
- 2 - 24" x 8mm
- 2 - 30" x 9mm
- 2 - 36" x 10mm

| PART # | MFG # | COLOR | U/M |       |   |
|--------|-------|-------|-----|-------|---|
| EK6621 | 06621 | MULTI | EA  | 11.65 | G |



### 25 PACK JAR ASSORTMENT

Bright red, blue, green, and yellow

- 6 - 10" x 4mm
- 5 - 18" x 8mm
- 5 - 24" x 8mm
- 2 - 30" x 9mm
- 2 - 36" x 10mm

| PART # | MFG # | COLOR | U/M |       |   |
|--------|-------|-------|-----|-------|---|
| EK6622 | 06622 | MULTI | EA  | 21.50 | G |

### RUBBER TARP STRAP 10-PACK

- 4 - 9"
- 2 - 15"
- 2 - 21"
- 2 - 31"

| PART #  | MFG # | COLOR | U/M |       |   |
|---------|-------|-------|-----|-------|---|
| EK06610 | 06610 | BLACK | EA  | 14.45 | G |

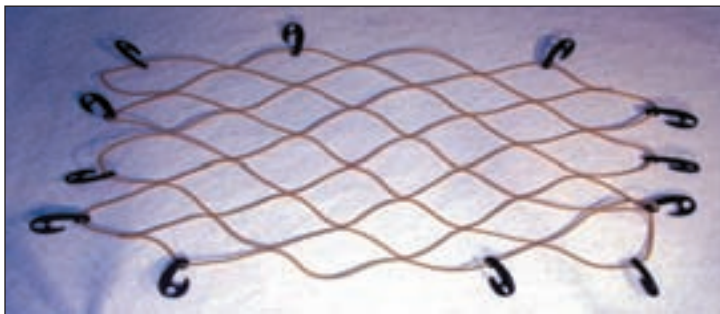

### CARGO NET

- Popular size for cartops, sport utility, mini vans, etc.
- Features strong 6mm stretch cord and 12 plastic hooks
- Attractive clam shell packaging
- Expands to size 36" x 48"
- Black

| PART # | MFG # | COLOR | U/M |       |   |
|--------|-------|-------|-----|-------|---|
| EK1010 | 01010 | BLACK | EA  | 14.25 | G |

- accessories
- towables
- body
- controls
- electrical
- driveline
- engine
- fuel & intake
- chemicals
- tie downs**
- tools
- towing & loading

# MARINE

## ERICKSON TIE DOWNS



- accessories
- towables
- body
- controls
- electrical
- driveline
- engine
- fuel & intake
- chemicals
- tie downs
- tools
- towing & loading

### IN BOARD/OUT BOARD TRANSOM TIE-DOWNS

- 2" x 4' - 1,200#
- Over-center lock buckle
- 2 pack

| PART # | MFG # | COLOR | U/M |       |   |
|--------|-------|-------|-----|-------|---|
| 266032 | 06100 | BLACK | PR  | 19.95 | G |



### TRANSOM/BOW U BOLT STYLE

| PART # | MFG # | COLOR | U/M |       |   |
|--------|-------|-------|-----|-------|---|
| 266035 | 53816 | STEEL | EA  | 11.95 | G |



### TRANSOM/BOW

- Stainless steel
- 3/8" x 3" threaded rod
- Nuts and washers included
- Sold each, bulk

| PART # | MFG # | COLOR | U/M |      |   |
|--------|-------|-------|-----|------|---|
| 266034 | 53909 | STEEL | EA  | 5.95 | G |





## ERICKSON TIE DOWNS

### ROPE RATCHET TIE DOWNS

- The Rope Ratchet's construction lets you secure a wide variety of loads quickly and easily
- With Rope Ratchet, you simply attach the two hooks and pull the loose end of the rope to the secure tightness you need
- With Rope Ratchet tie-downs, you never have to worry about stretching, snapping back, or loosening
- Your load stays secure because the rope stays locked in place with every pull until you release it by pushing the convenient thumb lever
- Display packaged
- 3 sizes



| SIZE       | LOAD LIMIT | PART #  | MFG # | U/M |       |   |
|------------|------------|---------|-------|-----|-------|---|
| 1/4" x 8'  | 150#       | EK01800 | 01800 | EA  | 13.60 | G |
| 3/8" x 8'  | 250#       | EK01801 | 01801 | EA  | 20.20 | G |
| 1/2" x 12' | 500#       | EK01805 | 01805 | EA  | 43.75 | G |



### LEVER ACTION - INDUSTRIAL CARGO BARS

| PART # | MFG # | DESC.      | U/M |       |   |
|--------|-------|------------|-----|-------|---|
| EK8906 | 08906 | 88" - 103" | EA  | 42.45 | B |
| EK8907 | 08907 | 60" - 75"  | EA  | 39.95 | B |

### RATCHETING - INDUSTRIAL CARGO BAR

| PART # | MFG # | DESC.      | U/M |        |   |
|--------|-------|------------|-----|--------|---|
| EK8909 | 08909 | 81" - 105" | EA  | 119.95 | B |



- accessories
- towables
- body
- controls
- electrical
- driveline
- engine
- fuel & intake
- chemicals
- tie downs
- tools
- towing & loading

MARINE

## ERICKSON TIE DOWNS



### ~ E-TRACK ACCESSORIES ~

- accessories
- towables
- body
- controls
- electrical
- driveline
- engine
- fuel & intake
- chemicals
- tie downs**
- tools
- towing & loading



### CAM LOCK LOGISTIC STRAP

- 2" x 10' - 2,000#
- Sold each, packaged

| PART # | MFG # | COLOR | U/M |       |   |
|--------|-------|-------|-----|-------|---|
| EK9151 | 09151 | BLUE  | EA  | 19.95 | G |

### 3,500 LB RATCHETING LOGISTIC STRAP

| PART # | MFG # | DESC.    | U/M |       |   |
|--------|-------|----------|-----|-------|---|
| EK9137 | 09137 | 2" x 16' | EA  | 26.90 | G |



### E-TRACK ADJUSTABLE TIRE STRAP

- For standard tires
- Sold each

| PART #  | MFG # | COLOR  | U/M |       |   |
|---------|-------|--------|-----|-------|---|
| EK08314 | 08314 | YELLOW | EA  | 42.75 | G |

### TIE-OFF

- 2" x 8" - 3,500#
- Sold each, packaged

| PART # | MFG # | COLOR | U/M |      |   |
|--------|-------|-------|-----|------|---|
| EK9143 | 09143 | BLUE  | EA  | 8.65 | G |





## BUYERS TIE DOWNS

### RATCHET TIE DOWN WITH J-HOOKS

- (1 ea.) 2" x 27' - 10,000#
- Great for ATVs, snowmobiles, boats, campers, motorcycles, trucks, and more!



| PART #  | MFG #     | COLOR  | U/M |       |   |
|---------|-----------|--------|-----|-------|---|
| BY12271 | RTD12271J | YELLOW | EA  | 37.95 | G |



### RATCHET TIE DOWNS

- (4 ea.) 1" x 12' - 1,800#
- Great for ATVs, snowmobiles, boats, campers, motorcycles, trucks, and more!

| PART #   | MFG #     | COLOR  | U/M      |       |   |
|----------|-----------|--------|----------|-------|---|
| BY411218 | RTD411218 | YELLOW | SET OF 4 | 26.95 | G |



### CAM BUCKLE TIE DOWNS

- (4 ea.) 1" x 6' - 1,200#
- Great for ATVs, snowmobiles, boats, campers, motorcycles, trucks, and more!

| PART #  | MFG #     | COLOR  | U/M      |       |   |
|---------|-----------|--------|----------|-------|---|
| BY41612 | CBTD41612 | YELLOW | SET OF 4 | 19.95 | G |

## SPI TIE DOWNS



### TIE DOWN STRAPS

- (2 ea.) 1" x 5 1/2' - 2,000#
- 4 colors
- Packaged in pairs for display

| PART # | MFG #    | COLOR | U/M |       |   |
|--------|----------|-------|-----|-------|---|
| 622142 | 12-140   | BLACK | PR  | 15.95 | L |
| 622143 | 12-140-3 | GREEN | PR  | 15.95 | L |
| 622146 | 12-140-1 | RED   | PR  | 15.95 | L |
| 622147 | 12-140-2 | BLUE  | PR  | 13.95 | L |



- accessories
- towables
- body
- controls
- electrical
- driveline
- engine
- fuel & intake
- chemicals
- tie downs
- tools
- towing & loading

MARINE

# TIE DOWNS

## PERFORMANCE TOOL TIE DOWNS



- accessories
- towables
- body
- controls
- electrical
- driveline
- engine
- fuel & intake
- chemicals
- tie downs
- tools
- towing & loading

### 2 PIECE 1" X 6' CAM BUCKLE SET

- (2 ea) 1" x 6' - 900#
- 1" wide synthetic webbing
- Die cast cam buckle
- Steel 'S' hooks, coated
- Clamshell packaged



| PART # | MFG # | COLOR  | U/M |       |   |
|--------|-------|--------|-----|-------|---|
| W1419  | W1419 | YELLOW | PR  | 14.60 | G |



### 2 PIECE RATCHETING TIE DOWN

- 1" wide synthetic webbing
- 4' - 15' adjustable length
- 500# breaking strength
- Clamshell packaged
- 2 pack

| PART # | MFG # | COLOR | U/M |      |   |
|--------|-------|-------|-----|------|---|
| W1424  | W1424 | RED   | PR  | 9.60 | G |

### RATCHETING TIE DOWN

- 1" wide synthetic webbing
- 4' - 15' adjustable length
- 1500# breaking strength
- Clamshell packaged
- Sold each



| PART # | MFG # | COLOR  | U/M |      |   |
|--------|-------|--------|-----|------|---|
| W1425  | W1425 | YELLOW | PR  | 8.75 | G |

### 4 PIECE RATCHETING TIE DOWN STRAP SET

- (4 ea.) 1" x 15'
- Locking ratchets
- Protective coated hooks
- Easy push button release
- Display packaged
- Set of 4 pieces
- Camo



| PART # | MFG # | COLOR | U/M      |       |   |
|--------|-------|-------|----------|-------|---|
| W1440  | W1440 | CAMO  | SET OF 4 | 29.70 | G |

### AUTOMATIC LOCKING TIE DOWNS

- (4 ea.) 1" x 6' - 1,200#
- Woven polyester straps
- Protective coat hooks
- Push button release

| PART # | MFG # | COLOR | U/M      |       |   |
|--------|-------|-------|----------|-------|---|
| W1446  | W1446 | BLUE  | SET OF 4 | 25.60 | G |



MARINE



## TITAN RATCHET TIE DOWNS

- Ratchet tie downs provide super strong holding power & precise tension adjustment
- Stylish Cast Handle Steel handle with padded grip
- Easy to reach release button



444215



444216



444217

| PART # | MFG #   |  | DUTY RATING | LOAD CAPACITY | BREAK STRENGTH |       |       |   |
|--------|---------|--|-------------|---------------|----------------|-------|-------|---|
| 444215 | 1157100 | TITAN RATCHET TIE DOWN 1" x 14' (SINGLE) | STD         | 600           | 1800           | BLACK | 18.94 | B |
| 444216 | 1157200 | TITAN RATCHET TIE DOWN 1" x 6' (2-PACK)  | STD         | 600           | 1800           | BLACK | 29.16 | B |
| 444217 | 1157300 | TITAN RATCHET TIE DOWN 1" x 10' (4-PACK) | STD         | 600           | 1800           | BLACK | 52.44 | B |



## TITAN MAXGRIP RATCHET TIE DOWNS

- Full open grip handle, fits any sized hand comfortably
- Cast aluminum handled ratchets
- Curved release button for ease of use



444218



444219



444220

| PART # | MFG #   |  | DUTY RATING | LOAD CAPACITY | BREAK STRENGTH |       |       |   |
|--------|---------|--|-------------|---------------|----------------|-------|-------|---|
| 444218 | 1158300 | TITAN MAXGRIP RATCHET TIE DOWN 1" x 14' (SINGLE) | HEAVY       | 1000          | 3000           | BLACK | 20.40 | B |
| 444219 | 1158400 | TITAN MAXGRIP RATCHET TIE DOWN 1" x 14' (2-PACK) | HEAVY       | 1000          | 3000           | BLACK | 32.93 | B |
| 444220 | 1158500 | TITAN MAXGRIP RATCHET TIE DOWN 1" x 14' (4-PACK) | HEAVY       | 1000          | 3000           | BLACK | 59.75 | B |



## CAMBUCKLE TIE DOWNS

- Vinyl coated S-hooks protect boats finish
- Provides super strong holding power
- Some models available with stainless steel housing



444221



444222

| PART # | MFG #   |  | DUTY RATING | LOAD CAPACITY | BREAK STRENGTH |       |       |   |
|--------|---------|--|-------------|---------------|----------------|-------|-------|---|
| 444221 | 2060166 | CAMBUCKLE TIE DOWN W/HOOKS - (BOW) 1" x 36" STAINLESS STEEL (2-PACK) | LIGHT       | 300           | 900            | BLACK | 24.04 | B |
| 444222 | 2060066 | CAMBUCKLE TIE DOWN W/HOOKS - (BOW) 1" x 36" ZINC (2-PACK)            | STD         | 400           | 1200           | BLACK | 15.56 | B |



## RATCHET TIE DOWN W/PADDED HANDLE

- Ratchet w/Padded Handle Tie Down
- 1" x 6',
- 1,800 lbs. - Break Strength



| PART # | MFG #   |   | DUTY RATING | LOAD CAPACITY | BREAK STRENGTH |        |       |   |
|--------|---------|---|-------------|---------------|----------------|--------|-------|---|
| 444239 | 1152101 | RATCHET TIE DOWN W/PADDED HANDLE - 1" x 6' (2-PACK) | STD         | 600           | 1800           | ORANGE | 23.83 | B |

- accessories
- towables
- body
- controls
- electrical
- driveline
- engine
- fuel & intake
- chemicals
- tie downs
- tools
- towing & loading

MARINE

# TIE DOWNS

- accessories
- towables
- body
- controls
- electrical
- driveline
- engine
- fuel & intake
- chemicals
- tie downs
- tools
- towing & loading



## CAMBUCKLE TRANSOM TIE DOWNS

- Locks in place to eliminate slippage
- Protective housing prevents scratches
- Some models available with stainless steel housing



| PART # | MFG #   |  | DUTY RATING | LOAD CAPACITY | BREAK STRENGTH |       |       |   |
|--------|---------|--|-------------|---------------|----------------|-------|-------|---|
| 444224 | 2060666 | SURELOK CAMBUCKLE TIE DOWN - (TRANSOM) 2" x 48" STAINLESS STEEL (2-PACK) | LIGHT       | 333           | 1000           | BLACK | 62.34 | B |
| 444225 | 2060466 | SURELOK CAMBUCKLE TIE DOWN - (TRANSOM) 2" x 24" ZINC (2-PACK)            | HEAVY       | 833           | 2500           | BLACK | 34.29 | B |
| 444226 | 2060766 | SURELOK CAMBUCKLE TIE DOWN - (TRANSOM) 2" x 48" ZINC (SINGLE)            | HEAVY       | 833           | 2500           | BLACK | 17.85 | B |



## RETRACTABLE TRANSOM TIE DOWNS

- Retractable Transom Ratchets
- Strap retracts for easy storage and no tangling
- Easy bolt on function (Hardware included)
- Some models available with stainless steel housing



| PART # | MFG #   |  | DUTY RATING | LOAD CAPACITY | BREAK STRENGTH |       |        |   |
|--------|---------|--|-------------|---------------|----------------|-------|--------|---|
| 444227 | 2061865 | RETRACTABLE TIE DOWN - (TRANSOM) 2" x 43" STAINLESS STEEL (SINGLE) | STD         | 600           | 1800           | BLACK | 60.98  | B |
| 444228 | 2060266 | RETRACTABLE TIE DOWN - (TRANSOM) 2" x 43" STAINLESS STEEL (2-PACK) | STD         | 600           | 1800           | BLACK | 129.71 | B |
| 444229 | 2061766 | RETRACTABLE TIE DOWN - (TRANSOM) 2" x 43" ZINC (SINGLE)            | HEAVY       | 833           | 2500           | BLACK | 30.86  | B |
| 444230 | 2060366 | RETRACTABLE TIE DOWN - (TRANSOM) 2" x 43" ZINC (2-PACK)            | HEAVY       | 833           | 2500           | BLACK | 74.21  | B |



## RETRACTABLE RATCHET TIE DOWNS

- Strap retracts for easy storage and no tangling
- Easy bolt on function (Hardware included)
- Some models available with stainless steel housing



| PART # | MFG #   |  | DUTY RATING | LOAD CAPACITY | BREAK STRENGTH |       |       |   |
|--------|---------|--|-------------|---------------|----------------|-------|-------|---|
| 444240 | 1153500 | RETRACTABLE RATCHET TIE DOWN - 1" x 6' (2-PACK)            | STD         | 400           | 1200           | CAMO  | 34.26 | B |
| 444241 | 1151801 | RETRACTABLE RATCHET TIE DOWN - 1" x 6' MOTORCYCLE (2-PACK) | STD         | 500           | 1500           | BLACK | 34.30 | B |
| 444242 | 1154000 | RETRACTABLE RATCHET TIE DOWN - 2" x 10' (SINGLE)           | HEAVY       | 1100          | 3300           | BLACK | 34.30 | B |

MARINE





## STAINLESS STEEL GUNWALE MAX GRIP RATCHET TIE DOWNS

- Gunwale Ratchets
- Vinyl coated J-hooks protect boats finish
- Provides super strong holding power



| PART # | MFG #   |  | DUTY RATING | LOAD CAPACITY | BREAK STRENGTH |       |       |   |
|--------|---------|--|-------------|---------------|----------------|-------|-------|---|
| 444231 | 2060866 | MAX GRIP RATCHET - (GUNWALE) 2" x 10' STAINLESS STEEL (SINGLE) | LIGHT       | 333           | 1000           | BLACK | 46.65 | B |
| 444232 | 2060966 | MAX GRIP RATCHET - (GUNWALE) 2" x 13' STAINLESS STEEL (SINGLE) | STD         | 400           | 1200           | BLACK | 47.53 | B |



## ZINC GUNWALE MAX GRIP RATCHET TIE DOWNS

- Gunwale Ratchets
- Vinyl coated J-hooks protect boats finish
- Provides super strong holding power



| PART # | MFG #   |   | DUTY RATING | LOAD CAPACITY | BREAK STRENGTH |       |       |   |
|--------|---------|---|-------------|---------------|----------------|-------|-------|---|
| 444235 | 2061266 | MAX GRIP RATCHET - (GUNWALE) 2" x 10' ZINC (SINGLE) | HEAVY       | 833           | 2500           | BLACK | 29.12 | B |
| 444236 | 2061366 | MAX GRIP RATCHET - (GUNWALE) 2" x 13' ZINC (SINGLE) | HEAVY       | 833           | 2500           | BLACK | 29.75 | B |
| 444237 | 2061466 | MAX GRIP RATCHET - (GUNWALE) 2" x 16' ZINC (SINGLE) | HEAVY       | 833           | 2500           | BLACK | 30.59 | B |
| 444238 | 2061566 | MAX GRIP RATCHET - (GUNWALE) 2" x 20' ZINC (SINGLE) | HEAVY       | 833           | 2500           | BLACK | 31.85 | B |



## RATCHET TIE DOWNS

- Versatile ratchet tie downs
- Made of power web plus webbing with a 900 pound capacity
- Easy to use, just attach and pump the handle
- Ratchet tightens down with vise like gripping power
- Perfect for all your trailering needs



| PART # | MFG #   |  | DUTY RATING | LOAD CAPACITY | BREAK STRENGTH |     |       |   |
|--------|---------|--|-------------|---------------|----------------|-----|-------|---|
| 444243 | 1169900 | RATCHET TIE DOWN (ENDLESS) 1" x 12' (SINGLE) | LIGHT       | 300           | 900            | RED | 11.62 | B |
| 444244 | 1170000 | RATCHET TIE DOWN W/HOOKS - 1" x 13' (Single) | LIGHT       | 300           | 900            | RED | 13.55 | B |
| 444245 | 1227000 | RATCHET TIE DOWN 1" 10' (SINGLE)             | LIGHT       | 300           | 900            | RED | 9.75  | B |

- accessories
- towables
- body
- controls
- electrical
- driveline
- engine
- fuel & intake
- chemicals
- tie downs**
- tools
- towing & loading

MARINE

# TIE DOWNS



## RATCHET TIE DOWNS

- Versatile ratchet tie downs
- Easy to use, just attach and pump the handle
- Ratchet tightens down with vise like gripping power
- Perfect for all your trailering needs



444247



444248



444249



444250

| PART # | MFG #   |   | DUTY RATING | LOAD CAPACITY | BREAK STRENGTH |      |       |   |
|--------|---------|---|-------------|---------------|----------------|------|-------|---|
| 444247 | 1152301 | RATCHET TIE DOWN W/HOOKS - 1" x 6' (2-PACK) | STD         | 500           | 1500           | CAMO | 23.21 | B |
| 444248 | 1170200 | RATCHET TIE DOWN - 1" x 6' (2-PACK)         | STD         | 500           | 1500           | BLUE | 23.21 | B |
| 444249 | 1170500 | RATCHET TIE DOWN - 1" x 14' (SINGLE)        | STD         | 500           | 1500           | BLUE | 15.75 | B |
| 444250 | 9010500 | RATCHET TIE DOWN - 1" x 10' (4-PACK)        | STD         | 500           | 1500           | RED  | 34.02 | B |



444251



444252



444253



444254

| PART # | MFG #   |   | DUTY RATING | LOAD CAPACITY | BREAK STRENGTH |        |       |   |
|--------|---------|---|-------------|---------------|----------------|--------|-------|---|
| 444251 | 1151601 | RATCHET TIE DOWN - 1-1/4" x 10' (2-PACK)                        | HEAVY       | 1100          | 3300           | YELLOW | 33.33 | B |
| 444252 | 1160400 | RATCHET TIE DOWN W/REFLECTIVE WEBBING (ATV) - 1" x 12' (4-PACK) | HEAVY       | 1100          | 3300           | BLACK  | 44.46 | B |
| 444253 | 1151701 | RATCHET TIE DOWN - 1-1/2" x 15' (SINGLE)                        | SUPER       | 1830          | 5500           | YELLOW | 31.67 | B |
| 444254 | 1152500 | RATCHET TIE DOWN W/HOOKS 2" x 25' (SINGLE)                      | SUPER       | 3330          | 10000          | YELLOW | 43.30 | B |



## SURELOCK CAM BUCKLE TIE DOWN W/HOOKS

- Will not damage cargo
- Leverage doubles the hold down force of a cam buckle
- Great choice for motorcycle or ATV Tie Down



444264

| PART # | MFG #   |   | DUTY RATING | LOAD CAPACITY | BREAK STRENGTH |  |       |   |
|--------|---------|---|-------------|---------------|----------------|--|-------|---|
| 444264 | 1152201 | SURELOK CAMBUCKLE TIE DOWN W/HOOKS - 1" x 6' (2-PACK) | STD         | 500           | 1500           |  | 24.47 | B |

MARINE



## CAM BUCKLE TIE DOWN W/HOOKS

- Will not damage cargo
- Leverage doubles the hold down force of a cam buckle
- Great choice for motorcycle or ATV Tie Down



444258



444260



444262

| PART # | MFG #   |  | DUTY RATING | LOAD CAPACITY | BREAK STRENGTH |         |
|--------|---------|--|-------------|---------------|----------------|---------|
| 444258 | 1033300 | CAMBUCKLE TIE DOWN W/HOOKS - 1" x 10' (SINGLE) | LIGHT       | 300           | 900            | 8.97 B  |
| 444260 | 1152401 | CAMBUCKLE TIE DOWN W/HOOKS - 1" x 6' (2-PACK)  | STD         | 400           | 1200           | 22.97 B |
| 444262 | 1034400 | CAMBUCKLE TIE DOWN W/HOOKS - 1" x 12' (SINGLE) | STD         | 400           | 1200           | 15.43 B |



## FAT BUNGEE

- Won't damage or dig into your cargo
- Extra wide, strong and secure
- Coated steel hooks are stronger than conventional hooks
- Rotating Fat Straps rotate 360 degrees for easy adjustment
- Reflective Fat Straps increase visibility for all drivers



| PART # | MFG #   |                                     |        |
|--------|---------|-------------------------------------|--------|
| 444266 | 9412000 | 20" FAT BUNGEE                      | 3.30 B |
| 444267 | 9413000 | 30" FAT BUNGEE                      | 3.72 B |
| 444268 | 9414500 | 45" FAT BUNGEE                      | 4.39 B |
| 444269 | 9414900 | 10"-45" ADJUSTABLE FAT STRAP BUNGEE | 5.78 B |

- Designed to secure objects to the vehicle
- Made from rubber cords for superior strength
- Coated steel hooks are stronger than conventional hooks
- Extra wide strap provides strong and secure hold
- It is color coded by length for convenient selection



| PART # | MFG #   |   |         |
|--------|---------|---|---------|
| 444271 | 9002600 | 18pc. FAT STRAP ASSORT 3-15", 2-18", 2-20", 2-24", 2-30", 2-32", 1-ORING, 4 MINI JAR PACK | 24.02 B |

accessories

towables

body

controls

electrical

driveline

engine

fuel & intake

chemicals

tie downs

tools

towing & loading

MARINE

# TIE DOWNS

accessories

towables

body

controls

electrical

driveline

engine

fuel & intake

chemicals

tie downs

tools

towing & loading

MARINE



## ADJUSTABLE STRAP FAT BUNGEE

- Won't damage or dig into your cargo
- Extra wide, strong and secure
- Extra wide, strong and secure
- Coated steel hooks are stronger than conventional hooks
- Rotating Fat Straps rotate 360 degrees for easy adjustment
- Reflective Fat Straps increase visibility for all drivers



| PART # | MFG #   |                                     |        |
|--------|---------|-------------------------------------|--------|
| 444269 | 9414900 | 10"-45" ADJUSTABLE FAT STRAP BUNGEE | 5.50 B |



## BUNGEE CORDS

- Coated steel hooks are 3X stronger than conventional hooks
- Won't bend, break, scratch or mar
- Color coded hooks for convenient selection
- Engineered to withstand even the harshest outdoor elements



| PART # | MFG #   |   |         |
|--------|---------|---|---------|
| 444272 | 2902000 | 12" TRIPLE STRENGTH BUNGEE BLUE                                 | 4.05 B  |
| 444273 | 2902100 | 18" TRIPLE STRENGTH BUNGEE RED                                  | 3.85 B  |
| 444274 | 2902200 | 24" TRIPLE STRENGTH BUNGEE GREEN                                | 4.81 B  |
| 444275 | 9302400 | 24" TRIPLE STRENGTH BUNGEE RED                                  | 2.91 B  |
| 444276 | 9303200 | 32" TRIPLE STRENGTH BUNGEE GREEN                                | 3.29 B  |
| 444277 | 2902300 | 32" TRIPLE STRENGTH BUNGEE PURPLE                               | 5.35 B  |
| 444278 | 2902400 | 32" TRIPLE STRENGTH BUNGEE BLACK                                | 5.08 B  |
| 444279 | 9304000 | 40" TRIPLE STRENGTH BUNGEE YELLOW                               | 3.29 B  |
| 444280 | 9305200 | 52" TRIPLE STRENGTH BUNGEE ORANGE                               | 4.59 B  |
| 444281 | 2902500 | TRIPLE STRENGTH ASSORTMENT (10 pc.) 2-12", 2-18", 2-24" & 4-32" | 22.26 B |
| 444282 | 2902600 | TRIPLE STRENGTH ASSORTMENT (5 pc.) 1-12", 1-18", 1-24" & 2-32"  | 11.93 B |

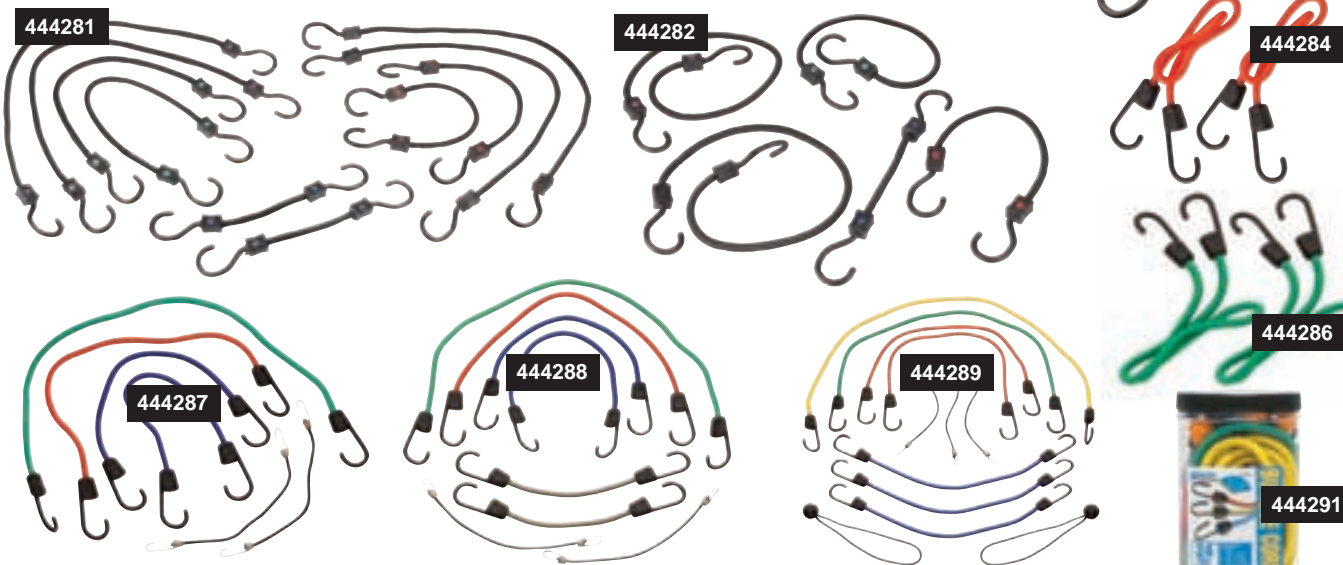

| PART # | MFG #   |  |         |
|--------|---------|--|---------|
| 444285 | 9402400 | 1pc. BUNGEE 24"  | 1.92 B  |
| 444286 | 9203200 | 2pc. BUNGEE 2-32" x 8mm  | 2.70 B  |
| 444287 | 9009500 | 6pc. BUNGEE ASSORTMENT 2-18", 1-24", 1-32", 2 MINI                       | 9.44 B  |
| 444288 | 9009600 | 8pc. BUNGEE ASSORTMENT 2-12", 2-18", 1-24", 1-32", 2 MINI                | 10.70 B |
| 444289 | 9008600 | 12pc. BUNGEE ASSORTMENT 2-12", 2-18", 1-24", 1-32", 2 MINI               | 12.20 B |
| 444291 | 9008400 | 24pc. BUNGEE CORD SET 6-18", 4-24", 2-32", 2-40", 4 CANOPY TIES JAR PACK | 22.50 B |





# TOOLS

# TOOLS

- apparel
- accessories
- towables
- body
- controls
- electrical
- driveline
- engine
- fuel & intake
- chemicals
- tie downs
- tools
- towing & loading

MARINE

## MINI GREASE GUN W/GREASE

- Heavy duty construction.
- "Pistol Grip" action for easy use in tight spaces.
- Vented zinc die cast head cap.
- Positive lock for easy filling.
- Air bleeder valve eliminates air lock.
- Uses 3oz grease cartridge (included).



260067 14.95 G

## PRO PISTOL GRIP GREASE GUN

- Professional quality heavy duty construction and chrome plated finish for long service life.
- Pistol grip action for easy use.
- Vented zinc die cast head cap.
- Positive lock for easy filling.
- Air bleeder valve eliminates air lock.
- 2 Way filling: standard 14 oz. grease cartridge or bulk.
- Comfort grip lever handle.



260066 18.95 G



## WHITE LITHIUM GREASE

- Includes zinc additives for a clean, white color
- Ideal for general home, shop, marine, snowmobile and industrial applications
- Provides superior performance and protection in most weather and temperature conditions

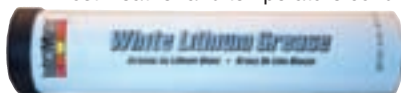

| DESCRIPTION         | QTY/CS | PART #  | MFG # |        |
|---------------------|--------|---------|-------|--------|
| 1 lb Resealable Tub | 12     | LB11350 | 11350 | 8.40 G |
| 14 oz Cartridge     | 10     | LB11354 | 11354 | 8.40 G |

## 2-PACK 3 OZ MULTI PURPOSE

- Multi purpose lithium based grease is designed for light duty applications which require extended lubrication.
- For light duty automotive, industrial, agricultural or commercial equipment.
- Smooth consistency, water resistant and extremely stable.
- Use on springs, water pumps, bearings, chassis fittings and any general lubrication projects.



260068 5.95 G

## MIDGET GREASE GUN KIT

- The ideal tool for the do-it-yourselfer
- Includes one midget gun and one 3 oz. cartridge of multi-purpose grease
- 2 way loading coupler has ball check to prevent leakage



| PART # | MFG #  |         |
|--------|--------|---------|
| 1727   | 30-192 | 22.15 G |

## LEVER ACTION GREASE GUN

- Three way loading
- Heavy duty performance
- Display carton packaging
- Uses 14 oz. cartridge
- Zinc plated for maximum rust and corrosion resistance



| PART #  | MFG #  |         |
|---------|--------|---------|
| LB11155 | 30-465 | 28.95 G |

## PRO GREASE GUN

- Professional quality heavy duty construction and chrome plated finish for long service life
- Short stroke "lever action" for easy use in tight spaces
- Vented zinc die cast head cap
- Positive lock for easy filling
- Air bleeder valve eliminates air lock
- Knurled thick wall barrel for secure grip
- Comfort grip lever handle
- Uses standard 14 oz. grease cartridge



| PART # | MFG #  |         |
|--------|--------|---------|
| W54202 | W54202 | 17.95 G |

## 12" FLEXIBLE HOSE

This grease gun hose features steel 1/8" NPT male fittings on each end. Good for up to 3,000 PSI recommended working pressure. 12,000 PSI burst pressure. This hose is intended for use on hand-operated grease guns. Flexible whip.



| PART #  | MFG #  |        |
|---------|--------|--------|
| LB11825 | 10-212 | 7.50 G |

## 15 QUART DRAIN CONTAINER

- Large capacity holds multiple oil changes
- Handle and spout for easy carrying and pouring control
- Built-in groove to drain filter



232114 17.95 G

## LESS MESS DRAIN PAN

- Extended profile catches full fluid flow
- 11 quart capacity for less spilling
- Built-in filter drain stand



232006 10.95 G

**40" PLASTIC CREEPER W/6 CASTERS**

The 40" Plastic Creeper w/6 Casters is made from molded plastic that is contoured to fit nearly anyone's body. This product has dipped down areas for your shoulders. It's incredibly light at only 10.5 pounds. Easily stores on the wall.



**260090 51.95 G**

**2 TON POWER PULLER**

- 2 ton pull capacity (rolling)/ 1 ton lift capacity
- Drop forged steel safety hooks
- Automatic notch at a time release for maximum safety
- Aircraft cable
- 12 foot cable



**W4000 43.50 G**



**OIL EXTRACTOR - 1 CHAMBER**

Oil changes are now a snap. Several strokes of the pump create a vacuum that neatly captures up to 6 liters (1.57 gal.) in the sturdy container. Pour spout is included to help empty container. Pump is removable for easy storage.



**967295 61.95 E**

**OIL EXTRACTOR - 3 CHAMBER**

Ideal for bigger jobs, this larger capacity oil/fluid extractor makes changing the oil on your 4-stroke PWC, boat, ATV, and more clean and hassle free. Holds up to 15 liters (3.92 gal.) in a sturdy portable container. Handle makes for easy transfer to recycling tank. Pump included.



**967296 121.95 E**

**7 QUART DRAIN PAN**

- Molded handles and pour spout.
- Easy to use.
- Chemical and solvent resistant, won't rust or corrode.
- 13 1/2" x 11" x 4".



**260065 3.95 G**



**5-GALLON PAIL PUMP**

- Pump measures 8 ounces per stroke of pump



**930069 37.95 G**



**MANUAL SIPHON PUMP**

- Easy to operate utilizing a large ball type siphon
- This top quality item is similar to the pump included with new heaters



**602 3.70 G**

**BATTERY SIPHON PUMP**

- NOT FOR USE WITH GASOLINE
- Convenience and quick fill time makes this a tremendously popular item
- Powered by two "D cell" batteries (not included)
- Packaged one per header card
- Our high quality makes this pump an easy "sell-up" to your manual pump customers



**601 13.85 G**

**SYTHON HOSE**

- Siphon liquids fast with the Sython Hose!
- Just shake to start the transfer
- 6 ft. hose



**62-07030 12.95 L**

- apparel
- accessories
- towables
- body
- controls
- electrical
- driveline
- engine
- fuel & intake
- chemicals
- tie downs
- tools
- towing & loading

**MARINE**

- apparel
- accessories
- towables
- body
- controls
- electrical
- driveline
- engine
- fuel & intake
- chemicals
- tie downs
- tools
- towing & loading

## DELUXE AUXILIARY TANK FOR FUEL-INJECTED SYSTEMS

- For use with new fuel-injected models with external fuel pumps as well as standard carburetor type motorcycles
- Upgraded petcock for easier opening and closing
- Built-in fuel return (for fuel-injected models) and breather on cap
- Graduated scale located on the side of bottle allows accurate measurement of fluid volume
- Includes 4 ft. of 1/4 in. fuel line
- Holds up to 2000cc or 1/2 gallon of fluid
- Tank can also be used for refilling transmission oil on some late model MX bikes
- Not designed for fuel storage



**142150 81.99 E**

## COMBO Y-DRIVE WRENCH

- Innovative dual-use design combines 6 tools into one
- 8 mm, 10 mm and 12 mm hex socket
- 4 mm, 5 mm and 8 mm hex drive
- Padded Y-shape for excellent grip and leverage
- Compact design is ideal for trail tool packs
- Chrome-vanadium tool steel
- Limited lifetime warranty



**144164 15.50 E**

## SPINNER T-HANDLE, BIT DRIVER

- Bearing mounted spinner provides faster and easier removal and installation of bolts and nuts
- 5/16 inch hex drive head accepts most common driver bits
- Magnet inside drive head holds drive bits firmly in place
- Narrow drive head profile fits into tight spaces
- Padded grip handle
- Chrome vanadium handle and shaft
- Durable chrome finish on shaft and handle
- Blue anodized spinner with laser engraved Motion Pro logo
- Shaft is 10 inches long
- Bits not included
- Limited lifetime warranty



**144171 26.99 E**

## T-HANDLE BIT DRIVER WITH NO. 1,2,3 METRIC PHILLIPS BITS

- High quality Motion Pro standard bit driver T-handle
- Features 5/16 inch drive heads at end of shaft and at each end of handle
- 5/16 hex drives accept most common driver bits
- Magnet inside driver heads hold drivers firmly in place
- Includes high grade S2 tool steel Phillips bits no. 1, no. 2, and no. 3 made to JIS metric standard
- Narrow drive head profile fits into tight spaces
- Chrome vanadium handle and shaft
- Durable chrome finish on shaft and handle
- Shaft is 10 inches long
- Limited lifetime warranty



**144172 21.99 E**

## 1/4 INCH TRI-DRIVE MINI T-HANDLE KIT

- Use T-Handle drive to tighten/loosen fasteners and shaft drive for quick installation/removal of fasteners
- 1/4 in. drive has a compact 6 inch drive shaft length
- Compact size for use in tight spaces and is easy to carry
- Includes 8, 10, 12 and 13 mm sockets
- Use with 1/4 in. drive sockets, hex drives, crow's foot, swivels, etc.
- Chrome-vanadium tool steel shaft and T-Handle
- Durable nickel pewter finish
- Limited lifetime warranty



**142305 18.99 E**



DUAL DRIVE L-HANDLES

- Impact resistant ergonomic molded handle reduces hand fatigue
- Use drive side to tighten/loosen fasteners and shaft side for quick installation/removal of fasteners
- Minis are a compact 7 1/2 in. shaft length for tight access and easy transport
- Use with 1/4 in. or 3/8 in. drive sockets, hex drives, crow's foot, swivels, etc.
- One piece chrome-vanadium tool steel shafts
- Durable nickel pewter finish
- Limited lifetime warranty



| DESCRIPTION                  | PART # |       |   |
|------------------------------|--------|-------|---|
| 3/8 in. Drive/10 in. Long    | 678361 | 13.50 | E |
| 1/4 in. Drive/10 in. Long    | 678363 | 11.99 | E |
| 1/4 in. Drive/7-1/2 in. Long | 142283 | 11.50 | E |

HEX-PRO™ & STAR-PRO™ PIVOT HEAD WRENCHES

- 180° swivel head with extra long handle for accessing hard to reach places
- Pivot design allows for easy rotation around obstructions
- Pivot design allows you to keep the wrench and fastener engaged when access is limited
- Great time saver
- Heat treated alloy tool steel
- Chrome plated finish
- Includes heavy duty folding canvas storage pouch
- Takes up less storage space than a typical hex key set



| DESCRIPTION   | PART # |       |   |
|---|--------|-------|---|
| Hex-Pro® Metric Set (3 mm, 4 mm, 5 mm, 6 mm, 8 mm, 10 mm) | 142331 | 78.99 | E |
| Hex-Pro® SAE Set (3/16", 7/32", 1/4", 5/16", 3/8")        | 142330 | 73.99 | E |
| Star-Pro® Torx® Set (T-25, T-27, T-30, T-40, T-45, T-50)  | 142332 | 88.99 | E |

TIPROLIGHT™ TITANIUM WRENCHES

- These super-light wrenches weigh less than one quarter of the weight of standard steel wrenches
- Made from tool-grade titanium alloy
- Extremely lightweight and compact design is perfect for trail tool packs
- Exclusive Motion Pro design for optimized strength and performance
- Titanium alloy will never rust or corrode
- Ergonomic handle
- Laser etched markings for easy identification
- Designed by Motion Pro
- Sets of 4 include heavy-duty nylon tool wrap
- Patented



| DESCRIPTION                 | PART # |        |   |
|-----------------------------|--------|--------|---|
| 8 mm                        | 142366 | 20.40  | E |
| 10 mm                       | 142367 | 25.99  | E |
| 12 mm                       | 142368 | 33.99  | E |
| 13 mm                       | 142369 | 40.99  | E |
| 14 mm                       | 142370 | 42.99  | E |
| Set of 4 (8,10,12, & 14 mm) | 142371 | 108.99 | E |
| Set of 4 (8,10,12, & 13 mm) | 142382 | 108.99 | E |

- apparel
- accessories
- towables
- body
- controls
- electrical
- driveline
- engine
- fuel & intake
- chemicals
- tie downs
- tools**
- towing & loading

MARINE

# TOOLS

- apparel
- accessories
- towables
- body
- controls
- electrical
- driveline
- engine
- fuel & intake
- chemicals
- tie downs
- tools
- towing & loading

## 1/4" DR QR TEARDROP RATCHET

- Quick Release feature for quick and easy socket changes
- Chrome vanadium alloy steel construction for strength and durability
- Polished nickel chrome plated finish resists corrosion
- 72 gear teeth



## 3 PC 1/4" DR EXTENSION SET

- Chrome vanadium alloy steel construction for strength and durability
- Polished nickel chrome plated finish resists corrosion
- Sizes: 2", 3" and 6"

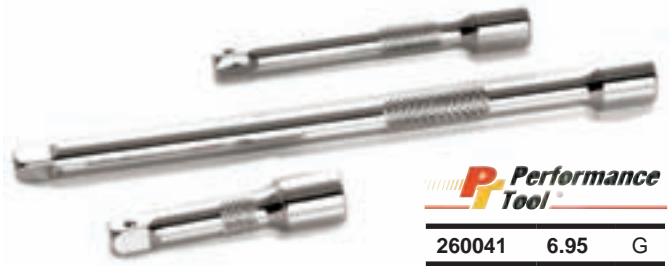

## 1/4" DR UNIVERSAL JOINT

- Chrome vanadium alloy steel construction for strength and durability
- Polished nickel chrome plated finish resists corrosion



## 1/4" F X 3/8" M ADAPTER

- Chrome vanadium alloy steel construction for strength and durability
- Polished nickel chrome plated finish resists corrosion



## 1/4" DR SOCKET RAIL

- 18" overall length
- Holds 14 sockets



## 10 PC 1/4" DR 6 PT SAE SOCKET SET

- Recessed edges.
- Socket openings are designed to reduce fastener rounding.
- Chrome vanadium alloy steel construction for strength and durability.
- Polished nickel chrome plated finish resists corrosion.
- Large stamping for quick identification.
- Packaged on plastic slide rail for storage.
- Sizes: 5/32", 3/16", 7/32", 1/4", 9/32", 5/16", 11/32", 3/8", 7/16" and 1/2"



## 10 PC 1/4" DR 6 PT SAE DW SOCKET SET

- Recessed edges.
- Socket openings are designed to reduce fastener rounding.
- Chrome vanadium alloy steel construction for strength and durability.
- Polished nickel chrome plated finish resists corrosion.
- Large stamping for quick identification.
- Packaged on plastic slide rail for storage.
- Sizes: 5/32", 3/16", 7/32", 1/4", 9/32", 5/16", 11/32", 3/8", 7/16" and 1/2"



## 10 PC 1/4" DR 6 PT MET SOCKET SET

- Recessed edges.
- Socket openings are designed to reduce fastener rounding.
- Chrome vanadium alloy steel construction for strength and durability.
- Polished nickel chrome plated finish resists corrosion.
- Large stamping for quick identification.
- Packaged on plastic slide rail for storage.
- Sizes: 4, 5, 6, 7, 8, 9, 10, 11, 12, and 13mm.



MARINE

## 10 PC 1/4" DR 6 PT MET DW SKT SET

- Recessed edges.
- Socket openings are designed to reduce fastener rounding.
- Chrome vanadium alloy steel construction for strength and durability.
- Polished nickel chrome plated finish resists corrosion.
- Large stamping for quick identification.
- Packaged on plastic slide rail for storage.
- Deep sizes: 4, 5, 6, 7, 8, 9, 10, 11, 12, and 13mm.



260039 21.95 G

## 36 PC 1/4" DR MECHANIC'S SET

- Socket openings are designed to reduce fastener rounding.
- Chrome vanadium alloy steel construction for strength and durability.
- Polished nickel chrome plated finish resists corrosion.
- Features high torque quick release ratchet. 72 gear teeth for 5 degree sweep.
- Smaller head for tight areas.
- 1pc each spinner handle, universal joint and 3" extension bar.
- 10pc standard SAE socket sizes: 5/32, 3/16, 7/32, 1/4, 9/32, 5/16, 11/32, 3/8, 7/16 and 1/2"
- 6pc Deep SAE socket sizes: 7/32, 1/4, 5/16, 3/8, 7/16 and 1/2".
- 10pc standard MM socket sizes: 4, 5, 6, 7, 8, 9, 10, 11, 12 and 13mm.
- 6pc Deep MM socket sizes: 4, 6, 7, 8, 10 and 12mm.



260040 49.95 G

## 3/8" DR QR TEARDROP RATCHET

- Quick Release feature for quick and easy socket changes.
- Chrome vanadium alloy steel construction for strength and durability.
- Polished nickel chrome plated finish resists corrosion.
- 72 gear teeth.
- Larger gear teeth for higher torque and added gear strength.



260044 22.95 G

## 3/8" DR UNIVERSAL JOINT

- Chrome vanadium alloy steel construction for strength and durability
- Polished nickel chrome plated finish resists corrosion



260045 3.95 G

## 3 PC 3/8" DR WOBBLE EXT SET

- Chrome vanadium alloy steel construction for strength and durability
- Polished nickel chrome plated finish resists corrosion
- Sizes: 1-3/4, 3 and 8"



260047 11.95 G

## 4 PC 3/8" DR EXTENSION SET

- Chrome vanadium alloy steel construction for strength and durability
- Polished nickel chrome plated finish resists corrosion
- Sizes: 1-3/4, 3, 6 and 8"



260046 11.95 G



## 3/8" F X 1/2" M ADAPTER

- Chrome vanadium alloy steel construction for strength and durability
- Polished nickel chrome plated finish resists corrosion



260048 2.95 G

## 3/8" F X 1/4" M ADAPTER

- Chrome vanadium alloy steel construction for strength and durability
- Polished nickel chrome plated finish resists corrosion



260049 2.95 G

- apparel
- accessories
- towables
- body
- controls
- electrical
- driveline
- engine
- fuel & intake
- chemicals
- tie downs
- tools
- towing & loading

# MARINE

- apparel
- accessories
- towables
- body
- controls
- electrical
- driveline
- engine
- fuel & intake
- chemicals
- tie downs
- tools
- towing & loading

## 3/8" DR 5/8" SP SOCKET

- Recessed edges.
- Socket openings are designed to reduce fastener rounding.
- Chrome vanadium alloy steel construction for strength and durability.
- Polished nickel chrome plated finish resists corrosion.
- Large stamping for quick identification.
- Overall socket length: 3-1/4".



**260050 6.95 G**

## 3/8" DR 5/8" SP SOCKET

- Recessed edges.
- Socket openings are designed to reduce fastener rounding.
- Chrome vanadium alloy steel construction for strength and durability.
- Polished nickel chrome plated finish resists corrosion.
- Large stamping for quick identification.
- Overall socket length: 3-5/16".



**260051 7.95 G**

## 3/8" DR SOCKET RAIL

- 18" overall length
- Holds 14 sockets



**260042 6.95 G**

## 5 PC SP SOCKET SET

- Recessed edges.
- Socket openings are designed to reduce fastener rounding.
- Chrome vanadium alloy steel construction for strength and durability.
- Polished nickel chrome plated finish resists corrosion.
- Large stamping for quick identification.
- SAE Sizes: 5/8, 3/4 and 13/16".
- Metric Sizes: 14 and 18mm.



**260021 18.95 G**



## 10 PC 3/8" DR SAE SOCKET SET

- Packaged on plastic slide rail for storage.
- Recessed edges.
- Socket openings are designed to reduce fastener rounding.
- Chrome vanadium alloy steel construction for strength and durability.
- Polished nickel chrome plated finish resists corrosion.
- Sizes: 1/4, 5/16, 3/8, 7/16, 1/2, 9/16, 5/8, 11/16, 3/4 and 13/16".



**260043 15.95 G**



## 10 PC 3/8" DR SAE DW SOCKET SET

- Packaged on plastic slide rail for storage.
- Recessed edges.
- Socket openings are designed to reduce fastener rounding.
- Chrome vanadium alloy steel construction for strength and durability.
- Polished nickel chrome plated finish resists corrosion.
- Deep sizes: 3/8, 7/16, 1/2, 9/16, 5/8, 11/16, 3/4, 13/16, 7/8 and 15/16".



**260053 27.95 G**



## 10 PC 3/8" DR MET SOCKET SET

- Packaged on plastic slide rail for storage.
- Recessed edges.
- Socket openings are designed to reduce fastener rounding.
- Chrome vanadium alloy steel construction for strength and durability.
- Polished nickel chrome plated finish resists corrosion.
- Sizes: 10, 11, 12, 13, 14, 15, 16, 17, 18 and 19mm.



**260052 15.95 G**

## 10 PC 3/8" DR MET DW SOCKET SET

- Packaged on plastic slide rail for storage.
- Recessed edges.
- Socket openings are designed to reduce fastener rounding.
- Chrome vanadium alloy steel construction for strength and durability.
- Polished nickel chrome plated finish resists corrosion.
- Sizes: 10, 11, 12, 13, 14, 15, 16, 17, 18 and 19mm.



**260055 27.95 G**



## 19 PC 3/8" DR BLACK SOCKET SET



- 18 double plated black sockets feature both SAE and Metric sockets in popular sizes.
- Easy to read laser etching.
- Ratchet features indestructible protective coating, chrome vanadium steel core with precision 72 gear teeth.
- 6pt SAE Sizes: 5/16, 3/8, 7/16, 1/2, 9/16, 5/8, 11/16, 3/4 and 13/16".
- 6pt MM sizes: 9, 10, 11, 12, 13, 14, 15, 17 and 19mm.



260054 29.95 A

## 51 PC 3/8" DR MECHANIC'S SET

- Features high torque quick release ratchet.
- 72 gear teeth for 5 degree sweep and smaller head for tight areas.
- 12pt SAE and Metric standard and deep wall sockets.
- Chrome vanadium alloy steel for strength and durability.
- Set contents: 1pc. 3/8" dr. quick release ratchet, 1pc. universal joint, 2pcs. 3 and 6" extensions, 2pcs spark plug sockets, 25pcs SAE and metric std. sockets and 20pcs. SAE and metric deep sockets.
- Durable storage case also included.
- SAE std. Sizes: 1/4, 5/16, 3/8, 7/16, 1/2, 9/16, 5/8, 11/16, 3/4, 13/16, 7/8 and 15/16".
- SAE Deep Sizes: 5/16, 3/8, 7/16, 1/2, 9/16, 5/8, 3/4, 13/16, 7/8 and 15/16".
- SAE Spark Plug sizes: 5/8 and 13/16".
- Metric std. Sizes: 7, 8, 9, 10, 11, 12, 13, 14, 15, 16, 17, 18 and 19mm.
- Metric Deep Sizes: 8, 10, 12, 13, 14, 15, 16, 17, 18 and 19mm.



260057 96.95 G



## 1/2" DR QR TEARDROP RATCHET

- Quick Release feature for quick and easy socket changes.
- Chrome vanadium alloy steel construction for strength and durability.
- Polished nickel chrome plated finish resists corrosion.
- 72 gear teeth.
- Larger gear teeth for higher torque and added gear strength.
- 9 1/2" Length.



260023 28.95 G

## 1/2" DR 15" FLEX HANDLE

- Chrome vanadium alloy steel construction for strength and durability.
- Polished nickel chrome plated finish resists corrosion.
- 15" length.

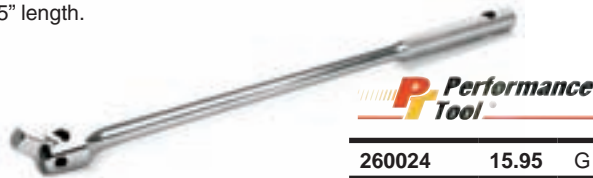

260024 15.95 G

## 1/2" DR UNIVERSAL JOINT

- Chrome vanadium alloy steel construction for strength and durability
- Polished nickel chrome plated finish resists corrosion



260025 4.95 G

## 3 PC 1/2" DR EXTENSION SET

- Chrome vanadium alloy steel construction for strength and durability
- Polished nickel chrome plated finish resists corrosion
- Sizes: 3,



260026 13.95 G



## 3 PC 1/2" DR WOBBLE EXT SET

- Chrome vanadium alloy steel construction for strength and durability
- Polished nickel chrome plated finish resists corrosion
- Increased angle flexibility
- Sizes: 3, 5 and 10"



260027 17.95 G



## 1/2" F X 3/8" M ADAPTER

- Chrome vanadium alloy steel construction for strength and durability
- Polished nickel chrome plated finish resists corrosion



260028 2.95 G

apparel

accessories

towables

body

controls

electrical

driveline

engine

fuel & intake

chemicals

tie downs

tools

towing & loading

MARINE

# TOOLS

- apparel
- accessories
- towables
- body
- controls
- electrical
- driveline
- engine
- fuel & intake
- chemicals
- tie downs
- tools
- towing & loading

MARINE

## 5 PC SP SOCKET SET 1/2" DRIVE SAE

- Recessed edges.
- Socket openings are designed to reduce fastener rounding.
- Chrome vanadium alloy steel construction for strength and durability.
- Polished nickel chrome plated finish resists corrosion.
- 6pt std. sizes: 1/2, 9/16, 5/8, 11/16, 3/4, 13/16, 7/8, 15/16 and 1".



**260022 19.95 G**



## 9 PC 1/2" DR MET SOCKET SET

- Recessed edges.
- Socket openings are designed to reduce fastener rounding.
- Chrome vanadium alloy steel construction for strength and durability.
- Polished nickel chrome plated finish resists corrosion.
- 6pt std. sizes: 12, 13, 14, 15, 16, 17, 18, 19 and 22mm.



**260029 19.95 G**



## 8 PC 1/2" DR SAE DW SOCKET SET

- Recessed edges.
- Chrome vanadium alloy steel construction for strength and durability.
- Polished nickel chrome plated finish resists corrosion.
- Large stamping for quick identification.
- 6pt deep sizes: 1/2, 9/16, 5/8, 11/16, 3/4, 13/16, 7/8, and 15/16



**260030 28.95 G**



## 8 PC 1/2" DR MET DW SOCKET SET

- Recessed edges.
- Chrome vanadium alloy steel construction for strength and durability.
- Polished nickel chrome plated finish resists corrosion.
- Large stamping for quick identification.
- 6pt deep sizes: 11, 12, 13, 14, 15, 16, 17, 18, and 19mm.



**260031 28.95 G**



## 10 PC MET HEX BIT SOCKET SET 3/8" DRIVE

- Chrome vanadium steel construction.
- Heat treated for strength.
- Bonus storage rail included.
- Metric sizes: 2, 3, 4, 5, 5.5, 6, 7, 8, 9 & 10mm.

**260016 19.95 G**



## 10 PC SAE HEX BIT SOCKET SET 3/8" DRIVE

- Chrome vanadium steel construction.
- Heat treated for strength.
- Bonus storage rail included.
- SAE sizes: 3/32, 7/64, 1/8, 9/64, 5/32, 3/16, 7/32, 1/4, 5/16 & 3/8".

**260015 19.95 G**



## 12 PC STAR BIT SOCKET SET

- Packaged on plastic slide rail for storage.
- Chrome vanadium alloy steel construction for strength and durability.
- Polished nickel chrome plated finish resists corrosion.
- 1/4" Drive sizes: T10, T15, T20, T25, T27 and T30.
- 3/8" Drive sizes: T40, T45, T47, T50 and T55.
- 1/2" Drive sizes: T60.



**260056 22.95 G**



## DRIVE HEX BIT SOCKET 5/32" X 3/8"

- Fits on all 3/8" ratchets
- 5/32" hex bit



**W38876 3.75 G**



## 22 PC SAE/MET BALL END HEX

- Alloy steel construction.
- Ball end wrenches are perfect for quick and convenient access to screw heads at angles up to 25 degrees.
- Includes plastic holder for storage.
- SAE sizes: 0.05, 1/16, 5/64, 3/32, 7/64, 1/8, 9/64, 5/32, 3/16, 7/32, 1/4, 5/16 and 3/8".
- Sizes: 1.5, 2, 2.5, 3, 4, 5, 6, 8 and 10mm.



**260062 12.95 G**

## 30 PC HEX KEY SET

- Long and short shank hex keys.
- Alloy steel construction.
- Includes handy organizer.
- 15 Metric hex keys, sizes: .7, .9, 1.3, 1.5, 2, 2.5, 3, 4, 4.5, 5, 5.5, 6, 7, 8 and 10 mm.
- 15 SAE hex keys, sizes: .028, .035, .050, 1/16, 5/64, 3/32, 7/64, 1/8, 9/64, 5/32, 3/16, 7/32, 1/4, 5/16, and 3/8"



**260063 12.95 G**

## 100 PC BIT SET

- Use with screwdrivers, electric drills or socket wrenches.
- Includes bit adapters, magnetic bit holder, "Y" style bits, couplers, Phillips, pozi, square, slotted, spanner, star, torque, tamper resistant star, hex triwing, clutch head and spline bits.



**260073 12.95 G**

## 7 PC FOLDING HEX KEY SET

- Heat treated alloy steel
- Chrome plated jack knife style holder
- Metric sizes: 1.27, 1.5, 2, 2.5, 3, 4 & 5mm



**W999 3.40 G**

## 10 PC T-HANDLE HEX KEY SET

- High quality carbon steel shafts
- Black oxide finish resists corrosion
- PVC T-handles for added torque and comfort
- Handy storage rack

SAE sizes: 3/32, 7/64, 1/8, 9/64, 5/32, 3/16, 7/32, 1/4, 5/16, and 3/8 in. Master 10 inner 1.



**W80274 17.95 G**

METRIC SIZES: 2, 2.5, 3, 4, 4.5, 5, 5.5, 6, 8 & 10 mm. Master 10 inner 1.

**W80275 17.40 G**



## 3 PC ALUMINUM HEX & STAR KEY SET

- Lightweight anodized aluminum body and chrome vanadium steel construction for strength and durability.
- Ball end on hex keys allow use at angles up to 25 degrees for obstructed areas.
- Star keys work on regular and tamper proof star fasteners.
- Keys conveniently fold for compact easy storage.
- Coded in high visibility colors for easy identification.
- SAE hex key sizes: 1/16, 5/64, 3/32, 1/8, 9/64, 5/32, 3/16 and 1/4".
- Metric hex key sizes: 1.5, 2, 2.5, 3, 4, 5, 6 and 8mm.
- Star key sizes: T9, T10, T15, T20, T25, T27, T30 and T40.



**260064 14.95 G**



- apparel
- accessories
- towables
- body
- controls
- electrical
- driveline
- engine
- fuel & intake
- chemicals
- tie downs
- tools**
- towing & loading

# MARINE

# TOOLS

- apparel
- accessories
- towables
- body
- controls
- electrical
- driveline
- engine
- fuel & intake
- chemicals
- tie downs
- tools
- towing & loading

## 8 PC HEAVY DUTY HEX KEY SET

- Heat treated alloy steel
- Includes handy key ring style holder to keep keys organized
- Metric sizes: 2, 2.5, 3, 4, 5, 6, 8 and 10mm



W1113 4.55 G



## BALL END ALLEN SET

- Made of chrome-vanadium tool steel
- Sizes: 1.5, 2, 2.5, 3, 4, 5, 6, 8 & 10 mm
- Ball end allows for better access to allen-head bolts (up to 25 degree working angle)
- Convenient holder included



678185 17.99 E

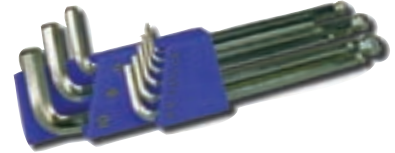

## 16 OZ BALL PEIN HAMMER

- Drop forged high carbon steel head.
- Heavy duty hardwood handle.



260012 6.95 G



## 4 LB SLEDGE HAMMER

- Heavy duty fiberglass handles for strength and durability
- Anti-shock, rubber cushion grips
- Mirror polish heads



260009 19.95 G



## 8 OZ RUBBER MALLET

- Rubber head
- Tubular chrome plated handle
- Rubber grip for comfort
- Many uses around home and shop



260014 2.95 G



## 16 OZ RUBBER MALLET

- Rubber head
- Tubular chrome plated handle
- Rubber grip for comfort
- Many uses around home and shop



260013 4.95 G



MARINE

## IMPACT DRIVER/BIT SET

- A heavy duty impact driver designed for general shop use
- Reversible, tightens screws or bolts on impact or loosens frozen ones easily
- Complete with 4 bits and metal storage case
- 3/8" square driver



Impact Driver / Bit Set W2500 17.75 G

Repl. 4 Piece Bit Set (Carded) EM03801 2.95 L

## 3 PC LOCK GRIP PLIERS SET

- Drop forged steel construction.
- Hardened and tempered milled teeth.
- Wire cutters and quick release levers.
- Includes three popular sizes - 5, 7 and 10".



260010 20.95 G



## 9-1/2" GROOVE JOINT PLIERS

- Drop forged steel.
- Cushion grips.
- Fully polished head.



|        |      |   |
|--------|------|---|
| 260011 | 8.95 | G |
|--------|------|---|

## 4 PC PLIERS SET

- Double cushion grip handles for comfort and control.
- Drop forged steel construction.
- Fully polished and chrome plated.
- Contents: 6" slip joint, 6" diagonal cutting, 6" long nose and 7" linesman pliers.



|        |       |   |
|--------|-------|---|
| 260019 | 15.95 | G |
|--------|-------|---|

## SMALL OIL FILTER PLIERS

- Comfort grip handles
- Safety button locks in place
- Three different positions
- Fits sizes 2-1/4" to 3-1/2" diameter



|        |      |   |
|--------|------|---|
| 260109 | 9.95 | G |
|--------|------|---|



## LARGE OIL FILTER PLIERS

- Comfort grip handles
- Safety button locks in place
- Three different positions
- Fits sizes 1-7/8" to 4" diameter



|        |       |   |
|--------|-------|---|
| 260110 | 11.95 | G |
|--------|-------|---|



## SWIVEL OIL FILTER WRENCH

- 2 15/16 to 3 3/4
- Swivel handle design provides access in confined areas
- Vinyl grip handle
- Studded band for better grip
- Removes most spin on type filters



|        |      |   |
|--------|------|---|
| 260111 | 5.95 | G |
|--------|------|---|

## CUP TYPE OIL FILTER WRENCH

Works with 3/8" drive wrenches



| PART #  | SIZE           |
|---------|----------------|
| EM04181 | 5.95 L 64.7 mm |
| EM04182 | 5.95 L 67 mm   |



- apparel
- accessories
- towables
- body
- controls
- electrical
- driveline
- engine
- fuel & intake
- chemicals
- tie downs
- tools
- towing & loading

# MARINE

# TOOLS

- apparel
- accessories
- towables
- body
- controls
- electrical
- driveline
- engine
- fuel & intake
- chemicals
- tie downs
- tools
- towing & loading

MARINE

## MINI MULTI TOOL W/MERCH STRIP

- Stainless steel multi tool features spring loaded plier jaws, wire cutters, slotted and Phillips screwdrivers, knife blades, bottle opener, nail file and more
- Handy in your pocket, purse, glove box or tool kit
- Lightweight and durable



|                           |       |   |
|---------------------------|-------|---|
| <b>P Performance Tool</b> |       |   |
| 260058                    | 10.95 | G |

## 3 PIECE DUAL CUSHION ADJUSTABLE WRENCH SET

- 12", 8" and 6" sizes
- 6 point hex openings
- SAE & Metric rules
- SAE box ends in handles 7/16", 1/2" and 5/8"



|                           |       |   |
|---------------------------|-------|---|
| <b>P Performance Tool</b> |       |   |
| W30703                    | 35.90 | G |

## 6" QUICK RELEASE C-CLAMP

- 6 Tough enamel finish
- Chrome plated screw threads
- Precision crafted for smooth operation
- Features quick-release button to save time and twisting
- Malleable iron construction



|                           |       |   |
|---------------------------|-------|---|
| <b>P Performance Tool</b> |       |   |
| 260080                    | 16.95 | G |

## CUT & PULL WIRE STRIPPERS

- Cuts and removes insulation from wire with a single squeeze of the handle
- Accepts 18, 14, 12, 10 and 8 gauge wire
- Heavy duty construction with vinyl hand grips



|                           |       |   |
|---------------------------|-------|---|
| <b>P Performance Tool</b> |       |   |
| W200                      | 14.30 | G |

## WIRE CRIMPING TOOL

- Wire cutter, bolt cutter, terminal crimper, wire stripper in 1 handy tool
- Black anodized finish with insulated hand grips
- Display packaged



|                           |      |   |
|---------------------------|------|---|
| <b>P Performance Tool</b> |      |   |
| W190                      | 4.50 | G |

## 7 WAY CRIMPING TOOL

- Wire cutter, terminal crimper and wire stripper in one handy tool
- Black anodized finish with insulated grips
- Crimp slot on end of tool secures most ignition terminals including "W" type, right angle and "High Tower" terminals
- Crimps 7 mm to 8.5 mm ignition wire
- Works with 10 to 22 gauge solderless terminals



|                           |      |   |
|---------------------------|------|---|
| <b>P Performance Tool</b> |      |   |
| W86500                    | 7.25 | G |

## 4 PIECE PLIERS & ADJUSTABLE WRENCH SET

- Double cushion grip handles for comfort and control
- Machined jaws for maximum gripping strength
- Drop forged alloy steel construction
- Cutting pliers feature induction hardened cutting edges for durability
- 6 in. (170 mm) diagonal cutter
- 6 in. (170 mm) long nose pliers
- 7 in. (185 mm) linesman pliers
- 8 in. (210 mm) adjustable wrench



|                           |       |   |
|---------------------------|-------|---|
| <b>P Performance Tool</b> |       |   |
| W1701                     | 23.30 | G |

## 7 PIECE DUAL CUSHION PLIER SET

- Perfect for a variety of tasks around the home, garage, or workshop
- Pliers feature comfortable grips
- set includes 10 inch groove joint pliers, 7.5 inch diagonal cutter, 8 inch long nose pliers, 4.5 inch mini diagonal cutter, bent nose plier, and end nipper pliers



|                           |       |   |
|---------------------------|-------|---|
| <b>P Performance Tool</b> |       |   |
| W30759                    | 35.40 | G |

## 15 IN 1 MULTI FUNCTION TOOL

- Compact 6 in. folding design deal for mechanics, campers, sportsmen and more
- Stainless steel blades and tools
- Lightweight aluminum handle with rubber grips for comfort
- Functions: standard pliers, long nose pliers, wire stripper, wire cutter, knife, saw, large slotted screwdriver, medium slotted screwdriver, small slotted screwdriver, Phillips screwdriver, can opener, serrated blade, fine edge, file, bottle opener



|                           |       |   |
|---------------------------|-------|---|
| <b>P Performance Tool</b> |       |   |
| W9321                     | 18.95 | G |

## 28 PIECE MECHANIC'S SCREWDRIVER SET

- Slotted, Phillips, Offset and Precision Screwdrivers, Star Drivers and Spark Plug Gapper
- Bonus 45°, 90°, Hook and Straight Pick Set



**W80028 33.60 G**

WITH BONUS SPECIALTY PICK SET



## 7 PIECE PROFESSIONAL SCREWDRIVER SET

- Extended length handle 3/8 x 8" slotted screwdriver
- 3/16 x 6", 3/16 x 4", 1/4 x 4" and 1/8 x 4" slotted
- #1 x 3", #2 x 4" Phillips
- Variety of sizes included for most jobs
- Display packaged



**W80007 12.75 G**

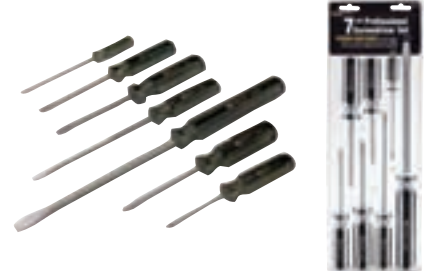

## 8 PIECE PROFESSIONAL SCREWDRIVER SET

- Oversize handles for easy use
- Magnetic tips
- Contains Phillips #1 X 3", #2 X 1-1/2", #2 X 4", Slotted 3/16" X 3", 1/4" X 1-1/2", 1/4" X 4", Star T-15, T-20 X 4"



**W80008 12.25 G**



## 6 PIECE SCREWDRIVER SET

- Popular sizes for a variety of fastening needs
- Oversized comfort grips for more turning power
- Heat treated alloy steel blades for durability
- Plated shafts for corrosion resistance



**W1703 13.20 G**



## 7 IN 1 STUBBY BIT DRIVER

- High torque ratchet
- 7 bits stored in handle
- Forward, locked, reverse



**W38927 8.90 G**



## 4 IN 1 STUBBY SCREWDRIVER

- Bits store in handle with magnetic hex bit holder
- Includes 3/16" & 1/4" slotted and #1 & #2 Phillips bits
- Each piece individually V.P.C'd
- Red in color



**W964 1.60 G**



## POCKET SCREWDRIVER COMBO

- Phillips and Slotted screwdriver bits
- Built-in level
- Mini LED light never needs replacing
- Handy pocket clip



**W9161 2.95 G**

Red, Blue or Yellow  
(Our Choice of Color)



Buy 12 and get a free display



- apparel
- accessories
- towables
- body
- controls
- electrical
- driveline
- engine
- fuel & intake
- chemicals
- tie downs
- tools
- towing & loading

# MARINE

# TOOLS

- apparel
- accessories
- towables
- body
- controls
- electrical
- driveline
- engine
- fuel & intake
- chemicals
- tie downs
- tools
- towing & loading

## 8 PIECE DO IT YOURSELF TOOL SET

- Great set for DIY projects/repairs around the home
- Utility knife
- Phillips and slotted screwdrivers
- Phillips and slotted precision screwdrivers
- 8 in. adjustable wrench
- 6 in. linesman pliers
- 10 ft. tape measure



**W1708 17.95 G**

## 6 PIECE HOME TOOL SET

- Versatile set for DIY projects, repairs around the house and general everyday use
- Phillips and slotted screwdrivers
- claw hammer
- slip joint pliers
- Utility knife
- 12 ft. tape measure



**W1707 26.20 G**

## 1/2" DRIVE TORQUE WRENCH

- Reads from 0-150 pounds
- Carded



**W3001 15.95 G**

## 1/2" DRIVE SLICK TORQUE WRENCH

- Chrome plated alloy steel
- \* 10 -150 ft. lbs
- \* 1 lb. graduations
- \* Ratchet style with engraved scale



**W20001 33.60 G**

## 11 PIECE FULL POLISH COMBINATION WRENCH SETS

- Fully polished chrome vanadium steel construction; includes most popular wrench sizes: 1/4, 5/16, 3/8, 7/16, 1/2, 9/16, 5/8, 11/16, 3/4, 13/16, 7/8
- Handy storage rack with easy to carry handle



SAE **W1061 19.95 G**  
Metric **W1062 19.95 G**



## FOLDING LB UTILITY KNIFE



- Combines the strength of a fixed blade w/ convenience of pocket knife
- Change blades with the push of a button
- Compact design folds down to 3 9/16" for easy storage & portability
- Blade locks in open position for safety
- Handy belt clip
- Available in red or blue handle

**BLUE HANDLE**

**260018 6.95 G**



**RED HANDLE**

**260017 7.95 G**



## UTILITY KNIFE & BLADES



- 3 position retractable blade
- Extra blade included stores in handle
- Indispensable around the home, shop & office



Knife **W745 4.10 L**  
Blades (5) **W744 1.80 L**

## BREAKAWAY UTILITY KNIFE

- Retractable blade with automatic lock
- End cap detaches to safely break blade tips
- Yellow in color

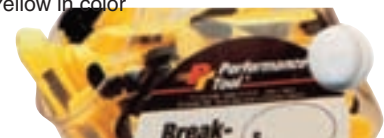

**W972 1.00 G**

MARINE

## MINI RAZOR SCRAPER

- Perfect at scraping labels & paint over spray off glass surface
- Tough polypropylene construction
- Protective safety cap
- Ergonomic grip for greater comfort & control
- Includes one standard razor blade



260060 2.95 G

## 1-1/4" RIGID OFFSET SS SCRAPER

- Perfect for removing gaskets, sealers & caked on materials
- Rigid stainless steel blade w/sharp chisel tip
- Ergonomic grip w/broad hilt for greater comfort & control
- Offset design for hard to reach areas



260072 5.95 G

## CARBON & GASKET SCRAPER



- Alloy steel construction
- Zinc plated to resist corrosion



W234 5.35 G

## 3 PC PRY BAR SET

Curved blade design provides extra leverage • Capped ends allow user to strike with a hammer without damaging the head • Blade protection for added safety • Sizes: 8", 12" and 17 3/4"



260020 12.95 G

## 2 PIECE SPECIALTY PICK SET



- Hardened tips
- Knurled center grips
- Also useful for retrieving small parts, nuts, washers, etc.
- Contains 90° double end scribe for etching metals and soft materials O-ring & Seal Pick for easily removing & installing O-rings & seals
- Carded



W80750 4.35 G

## 7 PC CHISEL & PUNCH SET

- Hardened and tempered high carbon steel construction.
- Vinyl covered shank absorbs shock and reduces vibration.
- Handy storage pouch.
- Pin punch sizes: 3/16 x 6".
- Taper punch sizes: 1/8 and 3/16 x 6".
- Center Punch sizes: 3/8".
- Cold Chisel sizes: 3/8, 1/2 and 5/8".



260061 10.95 G

## 8 PIECE SPECIALTY PICK & DRIVER SET

- Chrome vanadium steel shafts with magnetic tips
- High visibility PVC handles
- Contains: curved hook, offset 45° hook, 90° hook, straight pick, 1/8 in. slotted screwdriver, #0 Phillips screwdriver, T-15 star driver and T-20 star driver

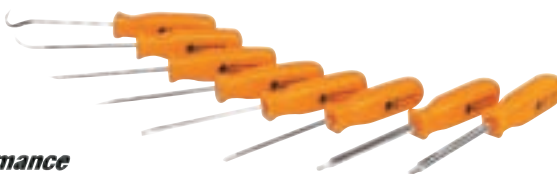

W941 5.95 G

## 3 PC STEP DRILL SET

- 1/4" hex shank 3 bit set replaces 17 individual drill bits.
- Titanium nitride coated high speed steel.
- For use with metal, wood and plastic.
- Starts on contact, no center punch needed.
- Automatically deburrs holes as you drill.



260091 15.95 G

## 29 PC DRILL BIT SET W/STEEL CASE

- Durable titanium nitride coated high speed steel.
- Sizes: 1/16" through 1/2" in 64th increments.
- Handy steel storage box included.



260092 36.95 G



- apparel
- accessories
- towables
- body
- controls
- electrical
- driveline
- engine
- fuel & intake
- chemicals
- tie downs
- tools
- towing & loading

# MARINE

- apparel
- accessories
- towables
- body
- controls
- electrical
- driveline
- engine
- fuel & intake
- chemicals
- tie downs
- tools
- towing & loading

## 5 PC TAPERED EXTRACTOR SET

- Removes broken studs, screws, bolts, pipes and pipe fittings.
- Chrome vanadium steel.
- Features flutes for more positive grip.
- Includes handy organizer.
- Sizes: 1/8, 3/16, 15/64, 5/16 and 3/8"



|        |      |   |
|--------|------|---|
| 260094 | 4.95 | G |
|--------|------|---|

## 40 PIECE TAP & DIE SETS

- Tap wrench, T-handle tap, wrench, die stock, screwdriver and screw pitch gauge
- NC, NF and NPT sizes
- 17 taps and 17 dies
- Storage case



|        |       |       |   |
|--------|-------|-------|---|
| SAE    | W4001 | 30.40 | G |
| Metric | W4002 | 30.40 | G |

## 4-1/2" ANGLE GRINDER

- 5/8-11 Spindle for Mounting the Most Popular Accessories
- 2-Position Side Handle
- Powerful 5 Amp Motor
- 11,000 RPM No-Load Speed
- Metal Gear Case Dissipates Heat for Longer Life
- Spindle Lock for Quick Wheel/Blade Changes
- Includes: 4-1/2" Grinding Wheel, Side Handle



|        |       |   |
|--------|-------|---|
| 260087 | 51.95 | G |
|--------|-------|---|

## 3 IN 1 STAPLER

- Easy slide open staple loading feature.
- Easy smooth squeeze.
- Handy storage case.
- Includes 300 staples, 300 nails and 300 U-Shaped staples.
- Comfort grip handle for extended use.



|        |       |   |
|--------|-------|---|
| 260076 | 15.95 | G |
|--------|-------|---|



## COMBO FINGERNAIL BRUSH W/MAGNET

- Combination fingernail, hand and utility brush
- Contoured handle for better grip



|        |      |   |
|--------|------|---|
| 260071 | 1.95 | G |
|--------|------|---|

## LED WORKLIGHT

- 24 super bright white LEDs
- Convenient built in hook
- Strong magnet attaches to almost any metal surface
- Swivel hook adjust to multiple angles and stores away easily
- Includes (3) AA batteries



|       |       |   |
|-------|-------|---|
| W2424 | 16.50 | G |
|-------|-------|---|



## 1 M CP SPOTLIGHT - BLACK

- High power quartz halogen bulb.
- Lockable trigger switch for hands free use.
- Comfort grip with built in hanging hook and tripod hole.
- Includes both a car charger and household charger.
- LED charge indicator light.
- Great for roadside emergencies, power failures, camping, boating, home, auto and more.



|        |       |   |
|--------|-------|---|
| 260078 | 21.95 | G |
|--------|-------|---|



## 12 VOLT MINI SPOTLIGHT

- 10 watt bulb
- Plugs into 12V receptacle
- Retractable cable (approx. 10 ft.)
- Includes strong magnetic mount



|       |      |   |
|-------|------|---|
| W2376 | 7.10 | G |
|-------|------|---|



**SUPER BRIGHT 9 BULB LED POCKET FLASHLIGHT**



- 3 1/2" tall
- Knurled barrel for extra grip
- Matt finish camo pattern
- Batteries included

Buy 16 and get a free display



W2452 5.95 G



**ALUMINUM LED FLASHLIGHT**

- Super Bright Nichia LED never needs replacing
- Anodized aluminum housing
- 55 lumens, 3.5 hour run time, 100m beam

Single LED Flashlight  
(Our Choice of Color)



W2451 4.95 G



**2 IN 1 LED LIGHT & LASER**

- Super bright LED on a flexible obedient head
- Red laser pointer
- Magnetic base and pocket clip keep light positioned where you need it
- Includes 3 LR44 batteries in light, and 3 more packaged with unit

2 in 1 Light & Laser  
(Our Choice of Color)



W2380 4.60 G

**2-PACK 55 LUMEN LED FLASHLIGHT**

- Super bright LED never needs replacing
- Anodized aluminum housing
- 2 count



W2459 10.95 G



**POCKET LED FLASHLIGHT**

- 3-1/2" Long, 1" Diameter
- LED glows at 55 lumens
- 3-1/2" hour run time with 100m beam
- Push-button On/Off
- Knurled barrel for better grip
- Ideal for tool box, car, or pocket
- Three AAA batteries included



W2450 4.95 G



**55 LUMEN TACTICAL LED FLASHLIGHT**

- Anodized tactical aluminum housing
- 55 Lumen light output
- 2120 Candela peak beam intensity
- 3.5 hour run time
- 100 meter beam distance
- Dimensions: 4.70 x 1.46 x 1.40 inches
- Weight: 0.2 pounds
- Water resistant
- Ring colors may vary



W2457 8.90 G



**5 LED MINI HEAD LAMP**

- Adjustable elastic headband
- Adjusts 90° for use anywhere
- Easy on and off, just twist
- Spring loaded slip attaches to hats and other thin items



W2393 6.95 G

**NGK LED POCKET FLASHLIGHT**

- 9 ultra-bright white LED's
- all lights continue to function even if one burns out
- AAA batteries included, not inserted
- 100,000 hours LED life cycle rating



228113 10.00 B

- apparel
- accessories
- towables
- body
- controls
- electrical
- driveline
- engine
- fuel & intake
- chemicals
- tie downs
- tools
- towing & loading

**MARINE**

# TOOLS

- apparel
- accessories
- towables
- body
- controls
- electrical
- driveline
- engine
- fuel & intake
- chemicals
- tie downs
- tools
- towing & loading

## 100 PC 8" WHITE CABLE TIES

- |        |      |   |
|--------|------|---|
| 260082 | 4.80 | G |
|--------|------|---|
- 100 Pc Cable Ties
  - 8" Length
  - Tensile Strength 40 Lbs
  - Resealable Bag



## 100 PC 8" BLACK CABLE TIES

- |        |      |   |
|--------|------|---|
| 260083 | 3.95 | G |
|--------|------|---|



## 50 PC 11" CABLE TIES

- 1/8" wide x 11" long.
- 25 white and 25 black.
- UL approved nylon.



- |        |      |   |
|--------|------|---|
| 260081 | 2.95 | G |
|--------|------|---|



## MULTI-PURPOSE CABLE TIES

HANDY ASSORTMENTS FOR THE HOME, OFFICE, OR SHOP

1000 Piece Package: includes:

| QTY | COLOR                              | LENGTH |
|-----|------------------------------------|--------|
| 100 | Yellow, Blue, Red, Green and White | 4"     |
| 100 | White                              | 6"     |
| 100 | Yellow, Red, White                 | 8"     |
| 100 | White                              | 12"    |



- |       |       |   |
|-------|-------|---|
| W2925 | 17.30 | G |
|-------|-------|---|

## MULTI-PURPOSE CABLE TIES

HANDY ASSORTMENTS FOR THE HOME, OFFICE, OR SHOP

250 Piece Package

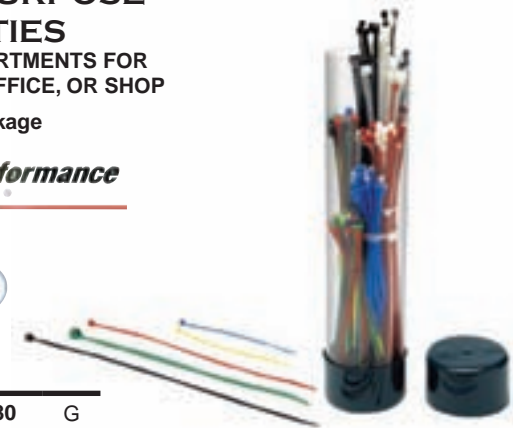

- |       |      |   |
|-------|------|---|
| W2918 | 7.80 | G |
|-------|------|---|

## 25' X 1" SAE/MET TAPE MEASURE

- Convenient and quick fractional readout every 1/8".
- Both SAE and Metric markings on tape measure blade.
- Durable casing stands up to rough treatment.
- Easy to find bright color.



- |        |      |   |
|--------|------|---|
| 260059 | 5.95 | G |
|--------|------|---|

## DIGITAL CALIPER

- Measures outside, inside depth and step 0-6"
- Large, easy to read led LED display
- Zero setting at any position within measuring range
- On/off switch
- Battery included
- Thumb wheel with lock
- Display packaged



- |        |       |   |
|--------|-------|---|
| W80152 | 25.95 | G |
|--------|-------|---|

MARINE

## 6" PLASTIC CALIPER

- 4 way measurements for outside, inside, step and depth.

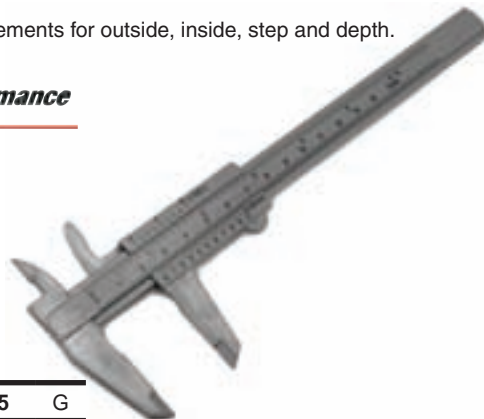

- |        |      |   |
|--------|------|---|
| 260093 | 1.95 | G |
|--------|------|---|

## 6" COMPOSITE DIGITAL CALIPER

- Rugged impact resistant composite material
- Easy to read SAE and metric LCD display
- Low battery warning with 12 month average battery life
- Includes 1.5V button cell battery
- Specifications: accuracy +/- .001" (.2 mm)
- Resolution: 0.0005"/0.01 mm
- Throat depth: 1 9/16"
- Temperature operating range: 32 deg. F to 104 deg. F
- Overall length: 9 1/2"

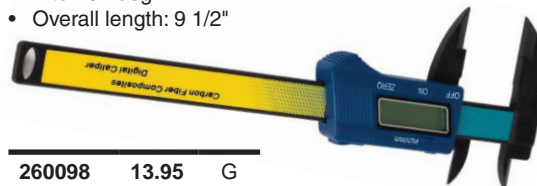

- |        |       |   |
|--------|-------|---|
| 260098 | 13.95 | G |
|--------|-------|---|



## SAE & METRIC SIZE CATCHER

- Instantly measure the size of any nut or bolt head
- Inch and metric gradations on opposite sides
- SAE range of 5/16 to 1 in. Metric range of 8 to 25 mm
- Easily carried in pocket or on key chain
- Display packaged

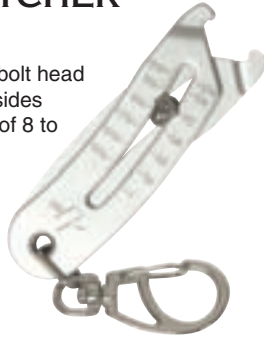

**W9162 7.05 G**

## SPARK PLUG GAP GAUGE

- Display packaged
- .020, .025, .028, .030, .032, .035, .040



**W162 2.30 G**

## SPARK PLUG GAPPER

- Easy to read markings
- Set gaps quickly & easily
- Range: .020" to .100" (.5 to 2.5mm)
- Tapered hole adjusts electrode
- Display packaged



**W80535 1.20 G**

## SPARK PLUG THICKNESS GAUGE

- 32 blades
- Decimal & metric sizes
- .010" brass blade for transistorized ignitions



**W125 6.60 G**

## SPARK PLUG GAUGE

- 8 spark plug gauges
- Decimal & metric sizes
- Electrode adjuster .015, .018, .020, .025, .028, .030, .035, .040, 0.40m, 0.45m, .50m, .064m, 0.70m, 0.75m, 0.90m, 1.00m
- Display packaged



**W127 4.55 G**

## SPARK PLUG THICKNESS GAUGE

- 15 blades
- Decimal & metric sizes
- 3" steel rule



**W131 4.30 G**

## TAPPET FEELER GAUGES

- Accurate tappet adjustments
- Angled blade for easy access to tappets
- Makes adjustment quick and easy



| CARD OF 6 |               |              |   | EACH      |               |             |   |
|-----------|---------------|--------------|---|-----------|---------------|-------------|---|
| .002-.003 | <b>678052</b> | <b>27.99</b> | E | .002-.003 | <b>142308</b> | <b>4.99</b> | E |
| .004-.005 | <b>678053</b> | <b>29.99</b> | E | .004-.005 | <b>142309</b> | <b>5.45</b> | E |
| .006-.008 | <b>678054</b> | <b>29.99</b> | E | .006-.008 | <b>142310</b> | <b>5.60</b> | E |

## 7 PC BEARING RACE & SEAL DR SET

- Quickly and easily installs wheel bearing races and seals without destruction to race or axle housing.
- Set includes six discs to fit common bearing sizes.
- Sizes: 1.565, 1.75, 1.965, 2.325, 2.47 & 2.555".



**260095 36.95 G**

## 120 PC MINI FUSE ASSORTMENT

- 120 Pc. Mini Blade Fuse Assortment.
- Contains 20 pieces each of: 5, 10, 15, 20, 25 and 30 Amp fuses
- Convenient storage case

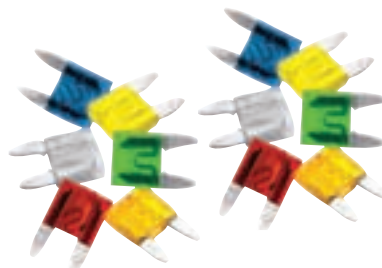

**260088 12.95 G**



- apparel
- accessories
- towables
- body
- controls
- electrical
- driveline
- engine
- fuel & intake
- chemicals
- tie downs
- tools
- towing & loading

# MARINE



SAFE WORK ENVIRONMENTS ARE EXPECTED TODAY! THAT DOES NOT HAVE TO MEAN THAT SAFETY PRODUCTS CANNOT BE BOTH DESIRABLE AND STYLISH. IN FACT SOME SAFETY PRODUCTS HAVE CLEARLY CROSSED THE LINE BETWEEN "HAVE TO WEAR" AND "WANT TO WEAR".

- apparel
- accessories
- towables
- body
- controls
- electrical
- driveline
- engine
- fuel & intake
- chemicals
- tie downs
- tools
- towing & loading

## RANGER POLYCARBONATE FRAME/LENS

- Functional safety glasses never go out of style
- Complete protection at a very economical price
- The design incorporates side shields and brow protection
- Lens made from uncoated Polycarbonate, and it provides excellent impact resistance, as well as 99.9% UV protection
- Amber lens improves contrast at dusk or in overcast conditions
- Fits over many prescription glasses
- Ranger complies with ANSI Z87.1-2003 (Z87+) and CE-EN-166



|       |              |             |   |
|-------|--------------|-------------|---|
| Clear | <b>EV10C</b> | <b>2.45</b> | B |
| Amber | <b>EV10A</b> | <b>2.65</b> | B |

## MAXIMUFF HIGH PERFORMANCE, ECONOMY EAR MUFF

- Super Seal ear cushions for long term comfort
- A soft cushioned headband
- Self-aligning suspension, and easy adjustment
- 28 dB NRR, 30 dB SNR



|             |              |   |
|-------------|--------------|---|
| <b>EV35</b> | <b>15.95</b> | B |
|-------------|--------------|---|



## VALUEMUFF COMFORT AND PROTECTION

- Soft and pliable Super Seal ear cushions
- Low headband force and light- weight, 6.8 oz.
- Easy adjustments with flexible slide clips
- Noise Reduction Rating down to 25 dB NRR - 28 dB SNR

|             |              |   |
|-------------|--------------|---|
| <b>EV25</b> | <b>10.30</b> | B |
|-------------|--------------|---|

## BLUE CORDED EAR PLUGS

- Cushioning foam, tapered pod design for easy insertion into any size ear canal
- Assures uncompromising seal
- Noise reduction rating of 32 db (decibels)



SAVE 10% WHEN YOU BUY 100!

|              |             |   |
|--------------|-------------|---|
| <b>EV211</b> | <b>0.40</b> | B |
|--------------|-------------|---|

## PROGUARD YELLOW SAFETY CAPS

- Elvex ProGuard safety caps offer the following features and benefits:
- The lightweight shell is made from tough Polyethylene
- ProGuard is available with pin-lock and two different ratchet suspensions
- The standard suspensions are made from flexible Polypropylene and have wide contact areas towards the head. This helps provide long term comfort and durability. A soft brow pad is standard.



|              |             |   |
|--------------|-------------|---|
| <b>EV304</b> | <b>7.50</b> | B |
|--------------|-------------|---|



**GO-SPECS™ LIGHTWEIGHT LIKE SAFETY GLASSES, SEALING LIKE GOGGLES**

Elvex Go-Specs™ primary objective is to provide an extra measure of protection in dusty and dirty environments. Wind blown particles such as dust, sand, cement, chemicals can cause serious eye irritation and damage. In addition to this specialized task, Go-Specs offers a full range of features and benefits:

- Impact resistant molded lens with SuperCoat™ anti-fog coating
- 1.8 mm thick Polycarbonate lens with a base 6 curvature
- Polyurethane foam seal
- Angle adjustable temples
- 99% UV protection for UV A, B and C, 180-380 nm
- Tested to ANSI Z87 (+)
- High velocity impact resistant

|                |              |              |   |
|----------------|--------------|--------------|---|
| Clear Anti-Fog | <b>EV401</b> | <b>10.20</b> | B |
| Gray Anti-Fog  | <b>EV402</b> | <b>10.55</b> | B |

**XENON ULTRA LIGHTWEIGHT DESIGN FOR COMFORT & STYLE**

- Elvex Xenon safety glasses represent our most lightweight design. They are so lightweight that it is easy to forget that you have them on.
- Xenon fits smaller faces and female faces very well.
- Comfortable and stylish design
- In addition to its good looks Xenon offers a soft rubber nose bridge and colorful rubber inserts on the temples.
- Tested to ANSI Z87.1-2003 (Z87+), and to CE EN-166.

|                |              |             |   |
|----------------|--------------|-------------|---|
| Clear          | <b>EV141</b> | <b>2.75</b> | B |
| Clear Anti-Fog | <b>EV142</b> | <b>3.65</b> | B |
| Blue           | <b>EV143</b> | <b>2.95</b> | B |
| Indoor/Outdoor | <b>EV144</b> | <b>3.40</b> | B |
| Gray           | <b>EV145</b> | <b>2.95</b> | B |
| Gray Anti-Fog  | <b>EV146</b> | <b>3.85</b> | B |
| Mirror         | <b>EV147</b> | <b>3.40</b> | B |



**ORBIT COOLEST STYLE YET**

- Cool wrap design with straight temples
- Straight rubber tipped temples
- Tinted lens version have a shiny silver frame
- Complies with ANSI Z87+

|                        |              |             |   |
|------------------------|--------------|-------------|---|
| Clear w/Graphite Frame | <b>EV361</b> | <b>5.75</b> | B |
|------------------------|--------------|-------------|---|

**ELITE FOR THE STYLE CONSCIOUS**

Styling aside, this frame offers a soft rubber nose bridge as well as rubber tipped temples. Complies to ANSI Z87.1-2003 (Z87+).

|                                  |               |             |   |
|----------------------------------|---------------|-------------|---|
| Clear w/Gray Frame               | <b>EV2001</b> | <b>5.25</b> | B |
| Clear w/Blue Frame               | <b>EV2002</b> | <b>5.25</b> | B |
| Gray Lens w/Black & Yellow Frame | <b>EV2003</b> | <b>5.50</b> | B |
| Indoor/Outdoor w/Gray Frame      | <b>EV2004</b> | <b>5.95</b> | B |



**TRIX HIGH STYLE COMBINED WITH LOW COST**

Trix safety glasses provide style and comfort at a very affordable price.

- Available in the following lenses: clear, clear anti-fog, gray, indoor/outdoor and silver mirror
- All lenses provide 99% UV protection
- Universal length temples
- Complies with ANSI Z87.1-2003 (Z87+) and CE-EN-166

|                |              |             |   |
|----------------|--------------|-------------|---|
| Clear          | <b>EV171</b> | <b>3.10</b> | B |
| Clear Anti-Fog | <b>EV172</b> | <b>3.95</b> | B |
| NCB Gray       | <b>EV173</b> | <b>3.30</b> | B |
| Indoor/Outdoor | <b>EV174</b> | <b>3.95</b> | B |

**UNIWRAPS THE MOST POPULAR**

UniWraps was one of the first wrap style safety glasses to integrate lens and side shield in a seamless design. This model has been re-engineered with a new frame and new temples that adjust in angle and length.

- Improved nose bridge makes these glasses very comfortable to wear
- Lenses available to protect against most harmful lighting conditions
- Complies with ANSI Z87.1-2003 (Z87+) and CE-EN-166

|       |              |             |   |
|-------|--------------|-------------|---|
| Clear | <b>EV201</b> | <b>6.80</b> | B |
|-------|--------------|-------------|---|



- apparel
- accessories
- towables
- body
- controls
- electrical
- driveline
- engine
- fuel & intake
- chemicals
- tie downs
- tools
- towing & loading

MARINE

# TOOLS

- apparel
- accessories
- towables
- body
- controls
- electrical
- driveline
- engine
- fuel & intake
- chemicals
- tie downs
- tools
- towing & loading

## 2" FINE CUPPED WIRE BRUSH

- 1/4" Shank
- Use with any power drill to remove paint, rust, dirt, etc.
- Useful for cleaning steel parts, surface preparation, deburring and edge blending

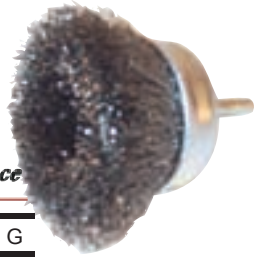

**Performance Tool**  
**W1212 4.60 G**

## UTILITY WIRE BRUSH

- Solid wood handle
- Steel bristles
- Carded



**Performance Tool**  
**W1152 2.80 G**

## T-HANDLE SOCKETS

- T-handle socket made of chrome vanadium tool steel
- Deep 6 point sockets with a carbon steel T-style handle
- Nickel pewter finish
- Hex socket extends only part way inside
- Lifetime warranty
- Thin wall

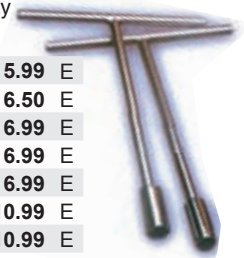

|      |        |       |   |
|------|--------|-------|---|
| 8mm  | 678093 | 5.99  | E |
| 10mm | 678094 | 6.50  | E |
| 12mm | 678095 | 6.99  | E |
| 13mm | 678096 | 6.99  | E |
| 14mm | 678097 | 6.99  | E |
| 17mm | 678098 | 10.99 | E |
| 19mm | 678099 | 10.99 | E |

## T-HANDLE RACK

- Chrome finish
- 11 slots
- Hooks on your tool box



**680144 17.99 E**



## WALL BRACKET FOR T-HANDLE RACK

- Wall bracket for T-handle rack above to mount on a wall, post, or any flat surface
- Features a quick release pin
- Heavy duty 12 gauge zinc plated steel
- Includes built in bottle opener



**680435 21.50 E**



## T-HANDLE DRIVES

- Use any 1/4 in drive attachments such as sockets hex drives crows foot or swivels
- Chrome vanadium tool steel shafts
- Durable nickel pewter finish
- Allows optional ways to use any 1/4 inches drive attachments such as sockets, hex drives, crows foot or swivels



|                          |        |      |   |
|--------------------------|--------|------|---|
| 1/4" drive, 8-1/2" long  | 678158 | 7.99 | E |
| 3/8" drive, 10-1/2" long | 678159 | 8.99 | E |

## 10 PC T-HANDLE STAR KEY SET

- PVC T-handle grips for added torque & comfort
- High quality carbon steel shafts
- Black oxide finish resists corrosion
- Handy storage rack
- Sizes: T7, T8, T9, T10, T15, T20, T25, T27, T30, T40



**Performance Tool**  
**W80276 17.40 G**

## SWIVEL SEAT BAR STOOL

Great for your garage, game room, etc.



- 30" high with 14" round seat
- Durable vinyl padded seat swivels 360°
- Sturdy chrome plated legs
- Non-slip rubber feet for stability

**W85010 54.90 G**



## ROLL-AROUND STOOL



- Pneumatic action adjusts seat to 20" height quickly & easily
- Convenient 15" diameter tool tray
- Shielded 2-1/2" casters
- Fully padded 12" diameter seat

**W85008 51.60 G**



## METRIC MULTI-PURPOSE TOOL

- A must-have for on-the-trail repairs or adjustments
- Can be used to remove 8 mm, 10 mm, 12 mm & 14 mm bolts, No. 2 & No. 3 Phillips screws, small & medium straight-slot screws and 5 mm & 6 mm hex bolts
- Includes a 1/4 in. & 3/8 in. socket driver
- 10 mm & 12 mm 1/4 in. drive sockets included
- Enhance it by adding your own 1/4 in. or 3/8 in. drive socket attachments
- Includes convenient carrying case
- Hard nickel pewter finish
- Perfect for any tool pack



**678030 58.99 E**



MARINE

## QUICK TIES

- Simple, secure, and strong
- Floats
- No knots, no stretching, no hooks to slip
- High density steel alloy core with high density foam coat
- Retail packaged
- 4 pack



BY5480 5.65 G

## 61 PIECE HAND RIVETER SET

- Includes riveter with 4 nozzles
- 15 each of the following rivets: 3/32, 1/8, 5/32 and 3/16 in.



W2017 15.20 G

## PISTON RING COMPRESSOR

- Use to install pistons on most passenger cars.
- Positive compression and adjustable friction brake.
- Instructions included.
- Band Diameter Sizes: SAE 2 1/8 to 5" (Metric 53 to 127mm)



260096 15.95 G

## PISTON PIN PULLER

Remove or install piston wrist pins easily with this puller from SLP. The body of this puller is made of a special high strength composite which eliminates marking, scarring or distortion of the piston. The face of the body of this puller is specially designed to bridge recessed wrist pin bosses found on late model pistons in order to provide a straight, precise pull each and every time. It is provided with three different sizes of nuts, which fit wrist pins from 15mm thru 24mm.



SP20181 59.95 B

## PISTON RING INSTALLER

- Installs and removes piston rings 3/64" (1.2-6.35mm)
- Comfortable vinyl grip handles



W80575 6.95 G

## NITRILE GLOVES

- 100% synthetic nitrile polymer
- Superior puncture, tear and chemical resistance with excellent dexterity
- Latex free and powder free, eliminates potential allergic reactions to natural rubber latex protein
- Textured surface provides strong grip for both wet and dry applications
- Protects hands from oil and grease
- Great for dirty/grimy jobs
- Universal fit for right or left hand



|    |        |       |   |
|----|--------|-------|---|
| M  | 144295 | 13.99 | E |
| LG | 142516 | 13.99 | E |
| XL | 142517 | 13.99 | E |

## SNAP RING PLIERS

- Economical pliers that easily does both inside and outside opening snap rings or clips
- Includes 3 extra sets of tips, 1 additional straight tip and 2 offset or angled tips



678186 15.99 E

## COMBINATION INTERNAL/EXTERNAL SNAP RING PLIERS

- Compress internal rings with one pair and expand external rings with the other
- Complete with 2 pliers and 4 sets of tips



1725 11.30 G

## CLAW & MAGNETIC RETRIEVERS

- Pick up bolts, screws, washers, etc. from confined areas
- Indispensable for home & workshop
- Flexible shaft reaches confined areas
- Strong durable magnets and powerful claws for easy retrieval
- Carded



24" Retriever Claw W1184 2.95 G

24" Magnetic Retriever W1182 3.10 G

## 8 LB. MAGNETIC PICKUP TOOL

- Heavy duty magnetic tip retrieves objects up to 8 lbs.
- Retriever extends over 24"
- Cushion grip handle
- Handy pocket clip
- Sold each



W9101 3.50 G

## POCKET MAGNETIC RETRIEVER

- Extends from 4 3/4" to 18 1/2"
- Convenient pocket clip
- Easily retrieves small parts from confined areas



W1261 2.55 G

## EMERGENCY TOW ROPE 1" X 15'

- 2" x 15 FT
- 8,500 lb. maximum load capacity
- Polyester webbing
- Heavy duty zinc plated hooks



W1420 21.30 G

## EMERGENCY TOW ROPE 2" X 20'

- 2" x 20' emergency tow strap, Poly webbing
- 10,000 lb. break strength capacity
- (3,300 safe working load)
- Heavy duty zinc plated hooks
- Intended for vehicle recovery
- Not intended for prolonged towing



W1422 25.40 G

- apparel
- accessories
- towables
- body
- controls
- electrical
- driveline
- engine
- fuel & intake
- chemicals
- tie downs
- tools
- towing & loading

# MARINE

- apparel
- accessories
- towables
- body
- controls
- electrical
- driveline
- engine
- fuel & intake
- chemicals
- tie downs
- tools
- towing & loading

MARINE

## 3 PIECE INSPECTION TOOL SET

- Lighted magnetic pickup tool
- Telescoping inspection mirror
- Mini magnetic parts tray



## SWIVEL INSPECTION MIRROR

- 2" round mirror with multi-direction swivel for visual access to confined areas
- Chrome plated corrosion resistant shaft extends from 11-1/2" to 18"
- Vinyl grip



## MAGNETIC TRAYS

- High quality heavy duty magnet
- Sticks to almost any metal surface
- Keeps small metal parts and tools from getting lost or misplaced
- Very handy even sideways or upside-down



## SMALL ENGINE CYLINDER HONE

- Fits 1-1/2" to 4" cylinders
- 1/4" flex drive
- Easy adjustments to any small engine application
- Length: 8-1/2"
- Complete with stone - plated



## PERFORMANCE TECH WEAR MECHANIC GLOVES

- Protects hands from cuts, scrapes and burns
- Comfortable and durable
- Thick enough to protect and thin enough to handle small objects
- Soft, flexible fabric is breathable and easy to clean

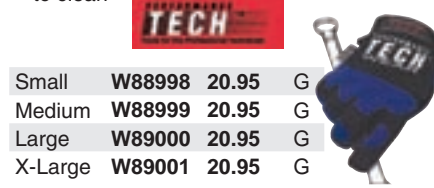

## DIGITAL MULTI TESTER

- For use on household appliances, automotive (computer controlled and standard ignitions)
- A variety of hobbies
- Features AC and DC volt measurement, DC current measurement, resistance measurement, diode test and ohms
- Complete with 2 test leads
- UL approved
- Detailed instruction booklet included
- Includes 9 volt battery



## BATTERY/ALTERNATOR VOLTAGE CHECKER

- For all 12 volt systems
- Easy to read LED lights
- Shows battery state-of-charge and level of alternator output



## POCKET MULTI-TESTER

- Analyzing functions for Volts AC, Volts DC, amperes and ohms
- Operates on 1 AA battery (included)
- Instructions included



## TUBE STYLE BATTERY TESTER

- Easy to read color coded hydrometer
- Gives precise readings for status of battery cells
- Acid resistant



## BATTERY TERMINAL CLEANER

- All metal construction
- Quality stainless steel brushes
- Cleans both battery post and terminals



## DELUXE 12 VOLT TESTER

- Checks 12V accessory circuits
- For autos, trucks, trailers and boats
- Test lead with alligator clip



## 12 VOLT HEAVY DUTY CIRCUIT TESTER

- Heavy duty 5 foot test lead with spring clip
- Tests 6, 12 & 24 volt AC and DC circuits
- Reinforcing spring prevents damage to test lead at base of handle

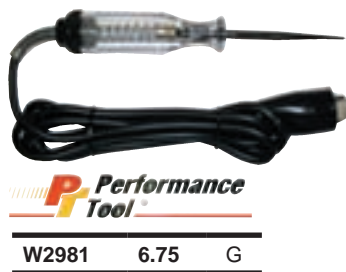

## ECONOMY IGNITION TESTER

An easy to use, time saving piece of shop equipment

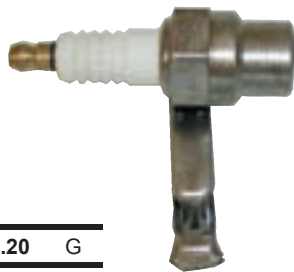

1754 11.20 G

## SPARK PLUG WIRE TESTER

- Identifies damaged spark plug wire easily by moving tool along wire towards spark plug
- Tester light flashes in sync with spark plug firing
- When light stops flashing, break in wire has been located
- Display packaged



W80530 8.30 G



## DUAL IGNITION SYSTEM TESTER

- Test the integrity and strength of your ignition system
- Spark plug gap is adjustable from 0 to 10 mm
- The larger the gap our ignition will jump, the stronger your system is
- Will test the ignition on most motorcycles, watercraft, ATVs and snowmobiles



678122 10.50 E

## IGNITION/SPARK PLUG TESTER

- Checks the integrity of the electrical ignition and magneto/coil ignition systems of lawn mowers, boat motors, motorcycles and automobiles
- Checks both current and voltage and will indicate fouled odes
- E-Z view LED and neon lamps for easy accurate reading, pocket size



7731 9.95 H

## DEGREE WHEEL

- Manufactured from .052 in. thick aluminum with a 6 3/4 in. outside diameter and a 6 mm center hole
- Black anodized finish with easy to read numbers
- Check or set ignition and/or cam timing
- May be used on 2 & 4-stroke engines



678092 14.99 E

## MINI SPRING HOOK TOOL

- Ergonomic handle provides a secure grip at every angle
- For use on exhaust pipe springs, seat or tank holding springs, cotter pins, side stand springs and more



144166 6.99 E

## SPRING HOOK

Exhaust spring tool with rubber coated handle



6212206 14.95 L

## HEAVY DUTY SPRING HOOK

- To compliment the current light duty spring hook tool, our heavy duty version developed specifically to handle those large diameter side-stand springs found on many street bikes
- The T-handle adds security to your grip when applying tension to the spring



678127 15.99 E



## BLIND BEARING & BUSHING REMOVER

- Set includes 30 mm, 25 mm, 20 mm, 17 mm, 15 mm, 12 mm, 10 mm and 8 mm collets
- 2 pound slide-hammer
- Crossbar type shaft allows easy collet removal
- Necessary tool for most transmission rebuilds
- Can be used for wheel bearing removal



142226 271.99 E

## DELUXE SPRING TOOL



214091 17.95 G

## DELUXE SPRING TOOL MULTI-PAK



214092 39.95 G



- apparel
- accessories
- towables
- body
- controls
- electrical
- driveline
- engine
- fuel & intake
- chemicals
- tie downs
- tools
- towing & loading

# MARINE

# TOOLS

- apparel
- accessories
- towables
- body
- controls
- electrical
- driveline
- engine
- fuel & intake
- chemicals
- tie downs
- tools
- towing & loading

## SUPER-DUTY BOOSTER CABLES

- 55% more power than 10 gauge cables
- Patent pending Cinch-Lock™ Technology for safer and easier jump starts



**232025 35.95 G**

## JUMPER CABLES

- Easy to use, easy to store
- Convenient storage bag
- Heavy duty, 8 ft., 8-gauge cables won't stiffen or freeze
- Tangle resistant, encased rubber grips for safer use



**920-228 25.95 E**

## BATTERY JUMPER CABLES

- Conveniently sized for motorcycle-to-motorcycle jump start
- Five feet in length
- Heavy-duty alligator clips are color-coded red and black
- Conductor wire is firmly soldered to clamp for durability and reliability



**142500 15.99 E**

## BATTERY JUMPER CABLE SET



- 64" long
- 10 gauge
- Color coded terminal
- Clamps for safe and secure handling
- Display packaged



**EM96300 12.95 L**

MARINE

## PVC ELECTRICAL TAPE

- Black
- Heavy gauge 7 mil. thermo-plastic UL approved for insulation of splices in insulated conductors of 5000 volt rating

**3/4" x 30' W501 0.75 L**

**3/4" x 60' W502 1.20 L**

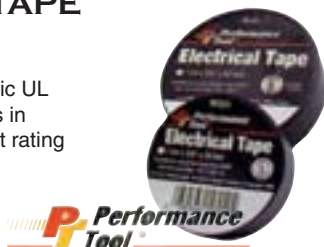

## DUCT TAPE

- 1-7/8" x 30'
- Sold each



**W3103 2.40 G**



## 2PC CAM BUCKLE SET (1" X 6')

- 1" x 6' cam buckle set
- 900 lb. break strength (300 lb. safe working load)
- 1" wide synthetic webbing
- Die cast cam buckle
- Steel "S" hooks
- Yellow
- 2-pack
- Display packaged



**W1419 14.60 G**





## SPARK PLUG WRENCH

- 12mm wrench - Fits all "D" size NGK spark plugs
- Zinc Plated
- 4-5/8" in length



**EM04110 4.95 L**



## HEAVY DUTY SPARK PLUG WRENCH

- 10mm - 14mm
- 3 way tip to fit all ATV spark plugs
- Chrome finish
- 2-7/8" in length



**EM04100 4.95 L**



## SPARK PLUG HOLE THREAD CHASER

- Quickly & easily cleans dust, carbon & metal particles from spark plug hole
- 18mm turn with 13/16" deep socket
- Display packaged



**W80539 7.25 G**



## RATCHET SPARK PLUG WRENCH

- Designed to fit where there is limited space on many water-cooled 2-stroke machines
- Ratchet mechanism works one way
- Fits standard 13/16" plugs



**678147 15.99 E**

## 3/8" DR SOCKETS 14MM/18MM

- Heat treated alloy steel
- Drop forged for strength
- Polished
- Display Packaged



14mm **W886 3.90 G**

18mm **W890 4.85 G**



## SPARK PLUG WRENCH

- Cast, chrome finished
- Combination wrench fits 14mm or 18mm spark plugs

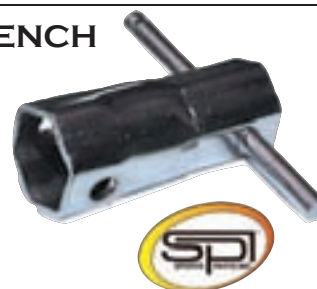

**LP15849 5.95 L**



## HEAVY DUTY NUT SPLITTER

- Removes rusted, stripped, and stubborn nuts
- Self-centering wobble tip
- Offset design for easier operation
- Splits nuts 7/16" to 3/4"
- Drop forged steel construction
- Plated to resist corrosion
- Heat treated chisel



**W88030 16.75 G**



## HEAVY DUTY 3 JAW GEAR PULLERS

- Heavy duty drop forged steel
- Heat treated for maximum strength
- Jaws plated for corrosion resistance
- Reversible jaws for multiple applications



4" **9020 14.95 B**

6" **9021 20.95 B**

8" **9022 30.95 B**



## UNIVERSAL FLY WHEEL PULLER

- One-piece machined design for extra strength
- Puller includes:
  - (6) 6mm bolts
  - (4) 8mm bolts with washers



**725-010 44.95 G**



## FLYWHEEL PULLER

- Equivalent to Yamaha tool 90890-01362, Kawasaki tool 57001-259
- Used for removal of the flywheel or rotor if applicable
- Premium quality high carbon steel
- Heat treated for strength and durability
- Durable hot black oxide finish
- Laser etched with Motion Pro logo and part number
- Limited lifetime warranty



## FLYWHEEL PULLER

- For most ATVs, snowmobiles, motorcycles and watercraft engines
- Complete with hardware kit and adapter for male or female removal



**629620 41.95 L**

| KAWASAKI |             | CC   | YEAR    | PART #        |         |
|----------|-------------|------|---------|---------------|---------|
| JS 300A  | 300 SX      | 0300 | 87 - 91 | <b>678160</b> | 29.99 E |
| JS 300B  | Jet Ski 300 | 0300 | 86 - 88 | <b>678160</b> | 29.99 E |
| JS 440A  | Jet Ski 440 | 0440 | 77 - 92 | <b>678160</b> | 29.99 E |
| JS 550A  | Jet Ski 550 | 0550 | 82 - 89 | <b>678160</b> | 29.99 E |
| JS 550B  | 550 SX      | 0550 | 90      | <b>678160</b> | 29.99 E |
| JS 550C  | 550 SX      | 0550 | 91 - 95 | <b>678160</b> | 29.99 E |

- apparel
- accessories
- towables
- body
- controls
- electrical
- driveline
- engine
- fuel & intake
- chemicals
- tie downs
- tools
- towing & loading

# MARINE

## 12V AUXILIARY POWER SOURCES

The following items provide a dependable source of power for electrical accessories using a standard adapter plug. For spotlights, tire pumps, GPS, cell phones etc. Can be installed on any 12V system such as snowmobiles, ATVs, tractors, boats, vehicles, motor homes etc.

### CIGARETTE LIGHTER WITH MAP LIGHT

30" extension with combination lighter/map light. Easy... Handy... Plugs into lighter socket. Comes with hang clip.



EM44420 14.95 L



### POWER OUTLET

12 Volt power outlet. Requires 12 volt battery source. Fits all Ski-Doo models plus many others. Replaces Ski-Doo #861-5072-00



571085 13.95 L

### CIGARETTE LIGHTER

Moisture-resistant lighter designed for all weather use in an open space. Clamp-on design fits almost anywhere.



EM44410 16.95 L



### UNIVERSAL DC CONNECTOR

With dash adapter. Will fit your electric shields, handlebar grip heater, hot socks, phone bags, etc. Rca standard.



621601 6.95 L

### EXTENSION POWER CORD

With On/Off switch. Can take up to 12 amp and 150 watts of current.



621201 9.95 L

### 9 FOOT POWER OUTLET

Clips to any 12 volt battery. Perfect item to plug in spotlights, cell phones, etc. 3 foot cord and 15 amp safety fuse. Plastic.



621203 6.95 L

### DUAL POWER OUTLET

The perfect solution when you want to plug in several items at one time.



621202 9.95 L

### 12-VOLT 3-WAY OUTLET

- 12-volt DC accessory plug
- Built-in 10 amp fuse protects against overload
- Useful for multiple 12-volt accessories: cell phone charger, GPS, laptop, strobe light
- Retail packaged

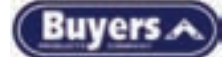

BY5601 6.45 G

### POWERPOINT 12 VOLT POWER OUTLET W/RELAY

- Wire length 150cm
- Mounts to your handlebars or can be installed without handlebar clamp
- 100% waterproof
- Includes everything needed to install



120140 48.95 L

### CIGARETTE LIGHTER POWER PORT

Equipped with an LED power-alert & USB output jack



120141 13.95 L

### RCA JACK DUAL SPLITTER

- Converts any single-output RCA power source into two power ports
- Works great when you need to operate communication systems, heated helmet shields and other electrical accessories



120142 5.95 L

### CIGARETTE LIGHTER POWER PORT

Equipped with an LED power-alert, RCA output jack



|                         |        |      |   |
|-------------------------|--------|------|---|
| Replaceable 10 Amp Fuse | 120120 | 9.95 | L |
| Non-replaceable Fuse    | 621200 | 7.95 | L |

### EMERGENCY CELL PHONE CHARGER

- Features 2 bright white LEDs
- Provides limited battery charge for emergency situations
- Charger specifications: Input voltage is 1.2 to 1.5 volts. Output voltage is 5.7v +/- 5%
- Charging time is 1 to 3 hours (varies by phone, battery levels and capacity)
- Typical efficiency is 88 to 93%
- Includes 7 adaptors for Nokia, Samsung, Sony Ericsson, Apple, Blackberry and Motorola brand cell phones



260077 10.60 G

apparel  
accessories  
towables  
body  
controls  
electrical  
driveline  
engine  
fuel & intake  
chemicals  
tie downs  
tools  
towing & loading

MARINE

## CARBURETOR LEAK DETECTOR

Provides a simple method of checking needle and seat pressure as well as impulse diaphragms, etc.

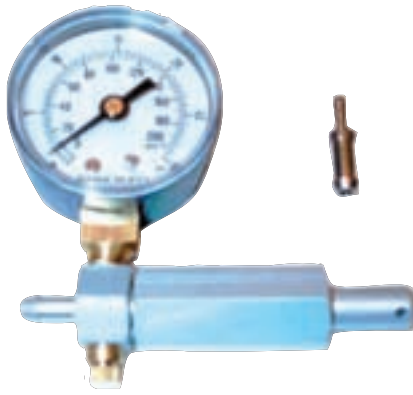

**LD1075 56.95 G**

## CARBURETOR VACUUM SYNCHRONIZER

### FOR BALANCING MULTIPLE CARBURETORS

This precision instrument gives mechanics and technicians a visual method of balancing carburetors with a high degree of accuracy, assuring the ultimate in performance from an engine



**ED4027 53.95 D**

## POP OFF GAUGE

Used to calibrate pop off pressure - calibrates 1/2 psi increments up to 30 psi

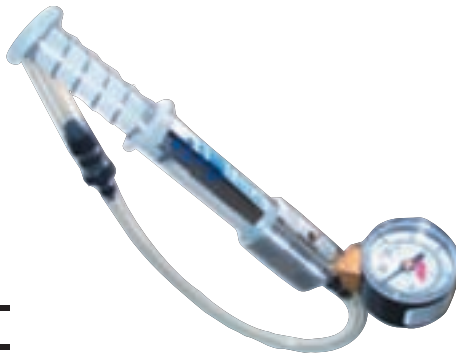

**MKBN 68.95 B**

## CARBURETOR POCKET TUNER

This pocket size calculator can be used to determine required jetting changes in carburetors due to changes in temperature and altitude.



**MK550 7.20 G**

## CARB ADJUSTING TOOL

Designed for multi-units. Fits both Mikuni and Keihin carburetors. 11" long, made of alloy steel.



**678022 18.99 E**

## MIKUNI CARB TOOL KIT

Service tool kit includes all tools necessary to service Mikuni carburetors.



Genuine Mikuni **VMTK 29.65 D**  
Imported **LP15866 14.95 L**

## 90 DEGREE 1/4 INCH HEX DRIVER

- Precision made of aircraft grade aluminum and stainless steel
- Designed for hard-to-reach areas and air/fuel mixture screws on multi-cylinder motorcycles
- Gear driven 1/4 in. hex drive
- Includes five 1/4 in. hex drive bits (all 1/2 in. long) - Straight-slot, Phillips, D-shaped air/fuel mixture screw bit, 6 mm hex jet bit & 1/4 in.-hex-to-1/4 in.-drive bit
- Can be used with any 1/4 in. or 6mm hex bits
- Strongest tool of its type on the market
- Max torque is 60 in. lbs.
- 17.5 in. long
- Replaceable drive gears
- Limited 1-year warranty
- Replaces OEM Harley-Davidson® #HD-33413-A



**142164 76.99 E**

- apparel
- accessories
- towables
- body
- controls
- electrical
- driveline
- engine
- fuel & intake
- chemicals
- tie downs
- tools**
- towing & loading

# MARINE

# TOOLS

- apparel
- accessories
- towables
- body
- controls
- electrical
- driveline
- engine
- fuel & intake
- chemicals
- tie downs
- tools
- towing & loading

MARINE

## COMPRESSION TESTER 0-300 PSI

- Tapered rubber tip fits all common spark plug holes.
- Large easy to read gauge.
- SAE (0 PSI to 300 PSI) and Metric (1 to 21 kg/cm2)



**260097 19.95 G**



## FCR CARB TOOL

- Contains longer bits for reaching into recessed cavities to adjust Keihin FCR carburetors
- Ideal for trail riders and garage mechanics alike
- Includes 6mm hex for main jets, long-reach straight slot for pilot jets & a 3mm Allen for float bowl removal.



**678181 16.50 E**

## MAIN JET WRENCH & CARRIER

- Rubber cap holds spare main jets in handle
- Aftermarket



**6mm hex 678023 5.50 E**

## SPARE JET CARRIER

Now you can store 19 spare main jets in a molded neoprene rubber carrier complete with special jet removal tool (LP15859). Carrier may be placed in tool box without loss or damage to precision jets.



**LP07301 7.95 L**

## SYNCPRO CARB TUNER

- Precise four channel vacuum indicator designed specifically for intake synchronization of engines with multiple carburetors or throttle bodies (max vacuum range 40cm Hg)
- New mercury-free design uses non toxic manometer fluid
- For use with any 2, 3 or 4 cylinder four stroke motorcycles
- Spill proof design means the tool can be stored in a horizontal or vertical position
- Rugged, impact resistant ABS enclosure with convenient storage area for adapters
- Includes manometer fluid, hoses, 5mm adapters, in-line restrictors and instructions
- Unaffected by barometric pressure changes
- Includes hang hook to clip onto the handlebars for easy use
- Easy to read scale for precise synchronization
- Rubber feet on enclosure bottom helps prevent sliding
- Optional 6mm adapters are available for use on most Yamaha models
- 5mm adapters are used on many Honda and Suzuki models
- Most Kawasaki models do not need adapters



**678411 102.99 A**

## 6MM CARB ADAPTOR SET

Replacement carb adaptor set for use with vacuum carb synchronization tools



**678040 10.50 E**

## SYNC PROMANOMETER FLUID REFILL

- Non-toxic / Mercury free
- Motion Pro blue color
- SyncPro Manometer Fluid Refill does NOT work with older Motion Pro mercury carburetor synchronizers



**678415 6.99 E**

## TWO-STROKE LEAK DOWN TESTER (DETECTOR)

- Designed to check for air leaks in 2-stroke engines
- Includes air pressure gauge, pump-up bulb and most fittings and adapters for single and twin cylinder 2-stroke motorcycle engines
- Packed in a convenient carry box, complete with instructions



**678071 308.99 E**

## COMPRESSION TESTER

- Designed to check cylinder compression
- Contains hoses for 10, 12 & 14mm spark plug applications
- Features a quick disconnect with a pressure release valve and a 3000 lb. gauge
- Packed in a convenient carry box, complete with instructions



**678188 119.99 E**

## STEEL O-CLIPS & PINCER TOOL

### PINCER TOOL

O-clip pincer tool is available to install and remove the O-clips

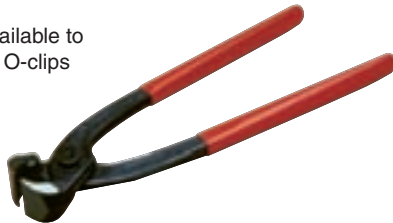

**670024 19.50 E**

### FUEL HOSE CLIP

- |               |                              |             |   |
|---------------|------------------------------|-------------|---|
| <b>670025</b> | 5/16" clips (for 3/16" hose) | <b>6.99</b> | E |
| <b>670026</b> | 7/16" clips (for 1/4" hose)  | <b>6.99</b> | E |
| <b>670027</b> | 1/2" clips (for 5/16" hose)  | <b>7.50</b> | E |

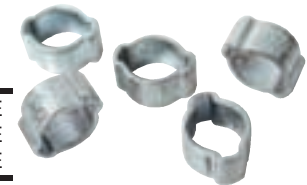

## STEPLESS CLAMP FUEL LINE FITTINGS KIT

- Convenient kit includes 70 pcs of hardware, a Motion Pro Side Jaw Pincer tool, and a convenient fuel line clamp size chart
- Kit includes following items packed in a convenient storage box:

Contains:

- |         |  |        |
|---------|--|--------|
| 142612  | Stepless Clamps, 7.8mm to 9.5mm range,   | 10 pcs |
| 143502  | Stepless Clamps, 9.6mm to 11.3mm range,  | 10 pcs |
| 142613  | Stepless Clamps, 10.3mm to 12.8mm range, | 10 pcs |
| 142614  | Stepless Clamps, 10.8mm to 13.3mm range, | 10 pcs |
| 142615  | Stepless Clamps, 12.0mm to 14.5mm range, | 10 pcs |
| 143503  | Stepless Clamps, 13.2mm to 15.7mm range, | 10 pcs |
| 142616  | Stepless Clamps, 14.8mm to 18.0mm range, | 10 pcs |
| 12-0073 | Side Jaw Pincer Tool                     |        |



**143504 124.99 E**



- apparel
- accessories
- towables
- body
- controls
- electrical
- driveline
- engine
- fuel & intake
- chemicals
- tie downs
- tools**
- towing & loading

# MARINE

- apparel
- accessories
- towables
- body
- controls
- electrical
- driveline
- engine
- fuel & intake
- chemicals
- tie downs
- tools
- towing & loading

## HARDWARE ASSORTMENTS



**200 PC SPRING ASSORTMENT**



W5200 9.05 L

**560 PC COTTER PIN ASSORTMENT**



W5205 10.70 L

**150 PC COTTER PIN ASSORTMENT**



W5206 14.20 L

**300 PC E-CLIP ASSORTMENT**



W5208 10.20 L

**150 PC HAIR PIN ASSORTMENT**



W5210 9.20 L

**300 PC SNAP RING ASSORTMENT**



W5212 9.50 L

**160 PC WIRE TERMINAL ASSORTMENT**



W52131 17.10 L

**70 PC GREASE FITTING ASSORTMENT**



W5215 15.20 L

**720 PC WASHER ASSORTMENT**



W5218 7.95 L

**200 PC HEX HEAD DRILL SCREW ASSORTMENT**



W5220 10.90 L

**347 PC NUT & BOLT ASSORTMENT-SAE**



W52211 7.30 L

**347 PC NUT & BOLT ASSORTMENT-METRIC**



W52221 7.30 L

**500 PC RIVET ASSORTMENT**



W5228 14.95 L

**150 PC WING NUT ASSORTMENT**



W5219 13.10 L

**1200 PC NUT, BOLT, & WASHER ASSORTMENT**



W5226 39.95 L

**285 PC MULTI-USE ELECTRICAL REPAIR KIT**



W5207 38.60 L

**120 PC FUSES**



W5368 13.95 L

**26 PC HOSE CLAMPS**



W5348 8.95 L

## METRIC KIT REPLACEMENT HARDWARE

Priced per package • Sold in packages of 10 only • All the popular metric nuts, bolts & washers that fit your atv, motorcycle and snowmobile

| PART # | DESCRIPTION & (HEAD SIZE)          | PART #  | DESCRIPTION & (HEAD SIZE)        | PART # | DESCRIPTION & (HEAD SIZE)      |
|--------|------------------------------------|---------|----------------------------------|--------|--------------------------------|
| MP0005 | Nut, 5mm (8mm) 0.80 G              | MP0110  | Nut, Flange 10mm (14mm) 2.86 E   | MP0206 | Nut, Nylock 6mm (10mm) 1.23 E  |
| MP0006 | Nut, 6mm (10mm) 1.23 E             | MP0112  | Nut, Flange 12mm (17mm) 3.83 E   | MP0208 | Nut, Nylock 8mm (12mm) 1.89 E  |
| MP0008 | Nut, 8mm (12mm) 1.57 G             | MP0405  | Nut, Acorn 5mm (8mm) 1.70 G      | MP0210 | Nut, Nylock 10mm (14mm) 3.52 E |
| MP0010 | Nut, 10mm (14mm) 1.89 E            | MP0406  | Nut, Acorn 6mm (10mm) 2.51 E     | MP1004 | Washer, Flat 4mm 0.60 G        |
| MP0012 | Nut, 12mm (17mm) 3.83 E            | MP0408  | Nut, Acorn 8mm (13mm) 2.23 E     | MP1005 | Washer, Flat 5mm 0.69 H        |
| MP0306 | Nut, Fuji-Lock 6mm (10mm) 3.83 E   | MP0410  | Nut, Acorn 10mm (14mm) 4.17 G    | MP1006 | Washer, Flat 6mm 0.92 E        |
| MP0308 | Nut, Fuji-Lock 8mm (13mm) 4.99 G   | MP0412  | Nut, Acorn 12mm (17mm) 5.14 G    | MP1008 | Washer, Flat 8mm 1.57 G        |
| MP0310 | Nut, Fuji-Lock 10mm (17mm) 6.50 G  | MP36251 | Washer, fender 6mm 1.57 G        | MP1010 | Washer, Flat 10mm 1.57 G       |
| MP0312 | Nut, Fuji-Lock 12mm (19mm) 13.26 E | MP38251 | Washer, fender 8mm 1.49 G        | MP1012 | Washer, Flat 12mm 1.75 G       |
| MP2004 | Washer, Lock 4mm 0.89 G            | MP0610  | Bolt, m6x10 (10mm) 1.60 G        | MP0415 | Bolt, m4x15 (12mm) 1.35 G      |
| MP2005 | Washer, Lock 5mm 1.71 G            | MP0615  | Bolt, m6x15 (10mm) 1.75 G        | MP0425 | Bolt, m4x25 (12mm) 3.55 L      |
| MP2006 | Washer, Lock 6mm 1.25 G            | MP0620  | Bolt, m6x20 (10mm) 1.99 G        | MP0810 | Bolt, m8x10 (12mm) 4.17 G      |
| MP2008 | Washer, Lock 8mm 2.15 G            | MP0625  | Bolt, m6x25 (10mm) 1.99 G        | MP0815 | Bolt, m8x15 (12mm) 3.30 G      |
| MP2010 | Washer, Lock 10mm 1.80 G           | MP0630  | Bolt, m6x30 (10mm) 2.35 G        | MP0820 | Bolt, m8x20 (12mm) 3.25 G      |
| MP2012 | Washer, Lock 12mm 3.55 G           | MP0635  | Bolt, m6x35 (10mm) 2.49 G        | MP0825 | Bolt, m8x25 (12mm) 3.49 G      |
| MP0520 | Bolt, m5x20 (8mm) 1.49 G           | MP0640  | Bolt, m6x40 (10mm) 2.75 G        | MP0830 | Bolt, m8x30 (12mm) 3.50 G      |
| MP0525 | Bolt, m5x25 (8mm) 1.59 G           | MP0645  | Bolt, m6x45 (10mm) 4.17 G        | MP0835 | Bolt, m8x35 (12mm) 5.80 G      |
| MP0530 | Bolt, m5x30 (8mm) 4.05 L           | MP0650  | Bolt, m6x50 (10mm) 2.50 G        | MP0840 | Bolt, m8x40 (12mm) 4.50 G      |
| MP1020 | Bolt, m10x20 (14mm) 7.59 G         | MP1220  | Bolt, m12x20 (17mm) 14.20 L      | MP0845 | Bolt, m8x45 (12mm) 6.43 E      |
| MP1025 | Bolt, m10x25 (14mm) 7.74 G         | MP1230  | Bolt, m12x30 (17mm) 16.15 L      | MP0850 | Bolt, m8x50 (12mm) 5.60 G      |
| MP1030 | Bolt, m10x30 (14mm) 8.64 E         | MP1816  | Bolt, Flange m8x16 (10mm) 2.99 G | MP2610 | Screw, Allen Head m6x10 2.80 G |
| MP1035 | Bolt, m10x35 (14mm) 9.99 G         | MP1820  | Bolt, Flange m8x20 (10mm) 2.99 G | MP2612 | Screw, Allen Head m6x12 2.74 G |
| MP1040 | Bolt, m10x40 (14mm) 11.39 G        | MP1825  | Bolt, Flange m8x25 (10mm) 3.49 G | MP2616 | Screw, Allen Head m6x16 3.11 G |
| MP1045 | Bolt, m10x45 (14mm) 12.50 G        | MP1830  | Bolt, Flange m8x30 (10mm) 3.50 G | MP2618 | Screw, Allen Head m6x18 3.46 E |
| MP1050 | Bolt, m10x50 (14mm) 12.50 G        | MP1835  | Bolt, Flange m8x35 (10mm) 3.99 G | MP2620 | Screw, Allen Head m6x20 3.46 E |
| MP1610 | Bolt, Flange m6x10 (8mm) 1.99 G    | MP1840  | Bolt, Flange m8x40 (10mm) 3.99 G | MP2625 | Screw, Allen Head m6x25 3.80 G |
| MP1616 | Bolt, Flange m6x16 (8mm) 2.25 G    | MP1850  | Bolt, Flange m8x50 (10mm) 5.25 G | MP2630 | Screw, Allen Head m6x30 4.17 G |
| MP1620 | Bolt, Flange m6x20 (8mm) 2.35 G    | MP3608  | Screw, Pan Head m6x8 1.99 G      | MP2635 | Screw, Allen Head m6x35 4.85 G |
| MP1625 | Bolt, Flange m6x25 (8mm) 2.30 G    | MP3612  | Screw, Pan Head m6x12 2.25 G     | MP2640 | Screw, Allen Head m6x40 4.85 G |
| MP1630 | Bolt, Flange m6x30 (8mm) 2.65 G    | MP3616  | Screw, Pan Head m6x16 2.25 G     | MP2645 | Screw, Allen Head m6x45 5.20 G |
| MP1635 | Bolt, Flange m6x35 (8mm) 2.75 G    | MP3618  | Screw, Pan Head m6x18 3.99 G     | MP2650 | Screw, Allen Head m6x50 5.57 G |
| MP1640 | Bolt, Flange m6x40 (8mm) 2.49 G    | MP3620  | Screw, Pan Head m6x20 2.75 G     | MP2655 | Screw, Allen Head m6x55 5.92 E |
| MP1645 | Bolt, Flange m6x45 (8mm) 2.99 G    | MP3625  | Screw, Pan Head m6x25 2.99 G     | MP2660 | Screw, Allen Head m6x60 6.75 G |
| MP2820 | Screw, Allen Head m8x20 5.80 G     | MP3630  | Screw, Pan Head m6x30 3.25 G     | MP2665 | Screw, Allen Head m6x65 7.05 G |
| MP2825 | Screw, Allen Head m8x25 6.29 E     | MP3635  | Screw, Pan Head m6x35 3.60 G     | MP2670 | Screw, Allen Head m6x70 7.50 G |
| MP2830 | Screw, Allen Head m8x30 6.99 G     | MP3640  | Screw, Pan Head m6x40 3.99 G     | MP3510 | Screw, Pan Head m5x10 1.25 G   |
| MP2835 | Screw, Allen Head m8x35 5.50 G     | MP3645  | Screw, Pan Head m6x45 4.10 G     | MP3512 | Screw, Pan Head m5x12 1.75 G   |
| MP2840 | Screw, Allen Head m8x40 5.89 G     | MP3650  | Screw, Pan Head m6x50 4.39 G     | MP3516 | Screw, Pan Head m5x16 1.99 G   |
| MP2845 | Screw, Allen Head m8x45 6.20 G     | MP3655  | Screw, Pan Head m6x55 7.74 G     | MP3520 | Screw, Pan Head m5x20 2.25 G   |
| MP0105 | Nut, Flange 5mm (8mm) 0.99 G       | MP3660  | Screw, Pan Head m6x60 8.20 G     | MP3525 | Screw, Pan Head m5x25 2.35 G   |
| MP0106 | Nut, Flange 6mm (10mm) 1.57 G      | MP0204  | Nut, Nylock 4mm (7mm) 0.99 G     | MP3530 | Screw, Pan Head m5x30 2.49 G   |
| MP0108 | Nut, Flange 8mm (12mm) 2.23 E      | MP0205  | Nut, Nylock 5mm (8mm) 0.99 G     |        |                                |

### TOOL PACK HARDWARE KIT CARD OF 12 PACKS

- Display holds 12 hardware kits
- Kits have 22 pieces that contain nuts, bolts, and washers most commonly needed for Off-Road/MX repairs
- Designed for modern off-road, MX and Dual Sport motorcycles
- Developed to carry in your T6 Tool Pack for trail side repairs, but equally as useful in your toolbox



**MP1200 59.88 G**



### METRIC HARDWARE KITS & REPLACEMENT HARDWARE

- Kits feature grade 5 hardware with a zinc finish
- Sold in an adjustable section box measuring 13.5" x 9.25"

**ALL KITS ARE 250 PIECES**

| PART # | DESCRIPTION   |          |
|--------|---|----------|
| MP0200 | Hardware Kit, Standard Metric Bolts: An assortment of 6mm bolts from 6x10 through 6x45, 8mm bolts 8x10 through 8x50 & 10mm bolts 10x20 through 10x50 (all in 5mm increments)                                | 134.99 G |
| MP0100 | Hardware Kit, Metric Nuts: An assortment of standard, nylock, flange, fuji lock and low dome acorn nuts   | 99.99 G  |
| MP0400 | Hardware Kit, Allen Bolts: An assortment of 6mm allen head bolts from 6x10 through 6x70, 8mm allen head bolts from 8x20 through 8x45 (all in 5mm increments)  | 129.99 G |
| MP0300 | Hardware Kit, Flange Head Bolts: An assortment of 6mm flange head bolts from 6x10 through 6x45 and 8mm flange head bolts from 8x16 through 8x50 (all in 5mm increments)                                     | 51.99 G  |
| MP0000 | Hardware Kit, Washers: An assortment of flat & lock washers from 4mm through 12mm. Includes 6mm (19mm outside dia.) and 8mm (22mm outside dia. fender washers)  | 49.99 G  |
| MP0500 | Hardware Kit, Pan Head Screws: Assortment of 5mm pan head screws from 5x10 through 5x30 (in 5mm increments) 6mm pan head screws including 6x8, 6x12, 6x16, 6x18, then 6x20 through 6x60 (in 5mm increments) | 78.99 G  |
| MP1100 | Hardware Kit, Off-road: All essential fasteners for an off-road mechanic's shop   | 42.99 E  |

- apparel
- accessories
- towables
- body
- controls
- electrical
- driveline
- engine
- fuel & intake
- chemicals
- tie downs
- tools
- towing & loading

# MARINE

## MOTORSPORTS CONTAINERS

- Ergonomically contoured handle and bottom grip for easy pouring.
- Extra large cap with rubber o-ring gasket.
- Made from virgin density polyethylene.
- Adjustable screw on air vent.
- Containers have accurate graduated marks indicating gallons and liters.
- 5 gallon capacity.
- Hose sold separately (Part #650643)
- Three year warranty



**HOSE SOLD SEPARATELY**

### SQUARE CONTAINERS



Red 650637 32.95 D



White 650636 32.95 D



Blue 650638 32.95 D

\* For each pink container sold, a percentage of the proceeds will be donated by VP Racing Fuels to support the cancer prevention research, education and community outreach programs of the Prevent Cancer Foundation. The VP Breast Cancer Awareness Motorsport Containers carry a 3-year limited warranty against cracks, leaks or splitting. Hoses not included.

NOTE: The VP Breast Cancer Awareness Motorsport Container is intended only for use as a rapid refueling device for racing vehicles used in professional off road and closed course competition racing events. It is NOT a portable fuel container as described by ASTM, EPA, ARB or other state or federal agencies. Intended for racing fuel only; not to be used for street legal fuels.



Pink 650646\* 32.95 D



Like all VP Sportsman's Containers, the rugged new Camo container is made with only the highest quality virgin high-density polyethylene, including 30% more material than standard containers to withstand the roughest treatment. The containers are subjected to a 15-point quality test and carry a 3-year limited warranty. They feature an ergonomically contoured handle, bottom grip for easy pouring and a non-breakable multipurpose cap with rubber gaskets.

Excellent for storage & transport of:

- Water
- Automotive & industrial fluid
- Deer corn, milo & oats
- Feed pellets, bird seed
- Rock salt
- Oil & liquid absorbents

Great for mixing/ dispensing:

- Animal attractants & feed
- Herbicides, insecticides



Camo 650659 32.95 D

- apparel
- accessories
- towables
- body
- controls
- electrical
- driveline
- engine
- fuel & intake
- chemicals
- tie downs
- tools
- towing & loading

# MARINE



**MOTORSPORTS  
CONTAINERS**

- Ergonomically contoured handle and bottom grip for easy pouring.
- Extra large cap with rubber o-ring gasket.
- Made from virgin density polyethylene.
- Adjustable screw on air vent.
- Containers have accurate graduated marks indicating gallons and liters.
- 5 gallon capacity.
- Hose sold separately (Part #650643)
- Three year warranty

**HOSE SOLD SEPARATELY**



**ROUND CONTAINERS**



Green 650639 32.95 D

Yellow 650640 32.95 D

Orange 650641 32.95 D

White 650642 32.95 D



Blue 650647 32.95 D



Red 650648 32.95 D



Orange/Black 650660 32.95 D

**REPLACEMENT PARTS**



Hose 650643 9.95 D



Cap 650644 9.45 D



Vent Cap 650645 1.95 D

- apparel
- accessories
- towables
- body
- controls
- electrical
- driveline
- engine
- fuel & intake
- chemicals
- tie downs
- tools
- towing & loading

MARINE

- apparel
- accessories
- towables
- body
- controls
- electrical
- driveline
- engine
- fuel & intake
- chemicals
- tie downs
- tools
- towing & loading



## REMOVES WATER FROM FUEL

The Fuel Filter Funnel by Mr. Funnel is a heavy-duty, anti-static, and fast flow funnel with built-in filter technology. When fuel is poured through the Fuel Filter Funnel, water and debris will not pass through the filter's fluoropolymer-coated stainless steel filter. Only filtered fuel flows through to your engine, improving its efficiency, durability, and proper operation. The sump area collects the deflected water and debris for proper disposal. The Fuel Filter Funnel by Mr. Funnel will filter gasoline, diesel, heating oil, kerosene and 2-cycle mixed gas.



### What Model Do I Need?

The Mr. Funnel Fuel Filter comes in four different fast-flow models (See below). Models differ mainly on flow rate. If your need is to transfer five gallons or less of fuel, then the F1 and F3 are for you. If you are transferring more than 5 gallons, then the F8 and F15 are right for you. Our F15 is our fastest flow model at up to 15 gallons per minute! This model can also be used at a fuel pump. Get your Mr. Funnel Fuel Filter today, and keep your engine running smooth!



◀ **MODEL: F1**  
for transferring five gallons or less of fuel  
Height: 6"  
Diameter: 3.5"  
Flow Rate: 2.5 gpm

**232000 19.55 B**



◀ **MODEL: F3**  
for transferring five gallons or less of fuel  
Height: 8.75"  
Diameter: 5.5"  
Flow Rate: 3.5 gpm

**232001 25.75 B**

**Flexible Spout Extension**  
for use with 232001 funnel only



**232004 6.15 B**



◀ **MODEL: F8**  
for transferring more than five gallons of fuel  
Height: 10"  
Diameter: 8.5"  
Flow Rate: 5.0 gpm

**232002 37.05 B**



*Our fastest flow model, this model can also be used at a fuel pump.*

◀ **MODEL: F15**  
for transferring more than five gallons of fuel  
Height: 10"  
Diameter: 8.5"  
Flow Rate: 12 gpm

**232003 70.00 B**



◀ **MODEL: F1NC**  
medium non-conductive portable fuel filter  
Height: 9"  
Diameter: 5.5"  
Flow Rate: 3.5 gpm

**232023 11.95 G**



◀ **MODEL: F3NC**  
small non-conductive portable fuel filter  
Height: 6"  
Diameter: 3.5"  
Flow Rate: 2.5 gpm

**232024 15.95 G**

## QUICKFILL® FUNNEL

- Speed channels maximize flow rate
- Distinct hand hold for a better grip
- No-mess splash guard



232007 2.95 G

## GAS GAUGE FUNNEL™

- Floating indicator signals when gas tank is full, helps prevent spills and overfills
- Great for lawn mowers and more
- Clip-strip included



232008 3.95 G

## TIGHT SPOT FUNNEL

- Fits Where Other Funnels Don't™
- Ideal for tight engine compartments
- Flexible design fits into tight spots



232009 3.95 G

## 2 QUART FUNNEL WITH SCREEN

- 2 quart capacity for large volume
- Filter screen included to clean fluids
- Built-in hang tag



232010 3.95 G

## 1 PINT FUNNEL WITH SCREEN

- 1 pint capacity, great for smaller engines
- Filter screen included to clean fluids
- Built-in hang tag



232011 2.95 G

## LOCKING OIL FUNNEL™

- Lock-in oil filler hole
- Funnel holds bottle while pouring
- No waste and no-mess quick pouring



232012 1.95 G

## TRANSMISSION FUNNEL

- 18" funnel made from durable high quality copolymer plastic
- Designed for hard to reach applications
- Perfect for transmission fluid



232013 2.95 G

## MULTI-TASK 5-IN-1 FUNNEL™

- Holds one quart oil bottle
- Three interchangeable spouts, including the Flexi-Spout
- Nestable



232014 5.95 G

## SUPER MULTI-PURPOSE FUNNEL™

- Large size (18") for multiple applications
- Perfect for transmissions and other engine fluids
- High perceived value allows for higher retail price points



232015 3.95 G

- apparel
- accessories
- towables
- body
- controls
- electrical
- driveline
- engine
- fuel & intake
- chemicals
- tie downs
- tools
- towing & loading

# MARINE

- apparel
- accessories
- towables
- body
- controls
- electrical
- driveline
- engine
- fuel & intake
- chemicals
- tie downs
- tools
- towing & loading

## FLEX FUNNEL™

- Ideal for hard to reach applications
- Distinct hand holds for a better grip
- Detachable flexible spout



232016 3.95 G

## 2-PIECE FUNNEL SET

- Multi-Purpose and Big Mouth funnel combo
- No-mess splash guards
- Covers all general purpose fluid applications



232017 2.95 G

## 3 PIECE SET GENERAL PURPOSE FUNNELS

- Includes small, medium & large funnels



232018 3.95 G

## TRANSMISSION FLUID/GEAR OIL SPOUT

- On/off adjustable flow spout
- Reduced tip for transmission filler tubes
- Fits quart or gallon containers



232019 4.95 G

## NO SPILL OIL SPOUT™

- Twist on, twist off
- No Spills, No Mess!™
- Adjustable built-in valve



232020 2.95 G

## SHAKER SIPHON™

- Moves up to 3.5 gallons a minute
- 6 foot anti-static tube
- Perfect for home, auto, ranch, marine or farm



232021 12.95 G

## SUPER SIPHON™

- Clear tube to view liquid flow
- Safe and easy to use
- Perfect for transferring all types of liquids



232022 5.95 G

## PLASTIC FUNNEL W/ 18" SPOUT

- 6 Diameter funnel
- 18 Flexible spout



260112 1.95 G

## 2 PIECE FLEX FUNNEL W/HANDLE

- Removable spout for multiple applications
- Easy hold handle



260113 2.95 G

## STA-DRI FUEL DRYER NOW IN PROTECTIVE TUBE!

- Don't let water contaminated fuel ruin an engine or freeze up a fuel line
- Stop water problems by trapping it inside the Sta-Dri water cell before it enters your fuel system
- 1" X 9" nylon bag in tube
- Bag can be dried and reused
- Bag weighted to stay at bottom of tank



**STD100 11.95 G**



## PLASTIC MEASURING CONTAINER

- Perfect for mixing and measuring gas and oil
- 2 sizes available



500 ml, 17 oz **62-12061 5.95 L**  
250 ml, 8.5 oz **62-12062 4.95 L**

## RATIO-RITE PERFECT GAS/OIL MIXTURE MEASURING CUP

- Get a perfect mix every time
- Fill your polypropylene Ratio-Rite to the pre-calibrated ratio mark and pour into gas
- Ratios are from 16:1 to 44:1 for 1, 1-1/2, 2, 2-1/2 gal.
- Calibrations also include oz., cc's, and pints on the opposite side for transmission oil, for oil, etc.
- Total capacity is 24 oz.



## REPLACEMENT LID FOR RR100

- Sold separately
- Seals the cup from dirt and spillage
- Lid can be attached to cup handle to keep from being misplaced



**RR105 2.55 L**

**RR100 6.15 L**

## FUNNELS

- Heavy duty USA made
- Polyethylene construction
- Fine mesh brass screen



2 Quart **PT493 3.99 G**

Fill All **PT520 5.39 G**

## 2 QUART PLASTIC FUNNEL

- Rugged, corrosion resistant all purpose funnel
- Complete with fine mesh straining screen and handy hanging tab
- Capacity indicates what the funnel will hold when the outlet is blocked



**W54276 3.60 L**

## ALL PURPOSE FUNNELS



**1/2 Pint**

**W4007 1.00 L**



**1 Pint**

**W4015 1.30 L**



**1 Quart**

**W4064 2.95 L**



**18 in.**

**W40340 3.60 L**

- apparel
- accessories
- towables
- body
- controls
- electrical
- driveline
- engine
- fuel & intake
- chemicals
- tie downs
- tools
- towing & loading

# MARINE

## HOUR METERS • MINI TACH • STOP WATCH

- apparel
- accessories
- towables
- body
- controls
- electrical
- driveline
- engine
- fuel & intake
- chemicals
- tie downs
- tools
- towing & loading

### HOUR METER

- Track the service life of your vehicle - track your oil changes, valve adjustments, spark plugs, etc.
- Easy installation - peel & stick, no wiring necessary, or attach with enclosed hardware, and no battery required, connects to spark plug wire
- Works on any gas engine
- Records & displays to 9,999.9 hours
- Hour glass symbol appears & flashes on/off to indicate counting time
- Automatic roll over
- 100% epoxy encapsulated casing resists water
- One year warranty



**HL8063 35.99 G**



### RE-SETTABLE HOUR METER DIRT BIKE, ATV & SNOWMOBILES

- Use on any gasoline engine 2/4 stroke
- Flashes "Clean Air Filter" at 5 hours
- Flashes "Change Oil" every 10 hours
- Flashes "Valve Service" every 20 hours
- All services count down the last 10 hours
- All services are easily reset with a touch of a button
- Timer Mode allows you to record individual sessions
- Total hours accumulated is not resettable



**HL8067 39.99 G**



### HOUR/TACH METER

- Has same features as hour meter plus tachometer feature
- Works on any gas engine up to 2 cylinders and 9000 rpm
- Firing pattern 1 spark = 1rpm
- Resolution 10 RPMs
- Maximum RPMs 9000
- Suitable for all single and twin, two or four cycle gasoline engines operation within specified tachometer firing pattern



**HL8061 35.99 G**



### VIBRATION METER

- Track the service life of all non-engine applications - automatic vibration activated recording
- Easy installation - peel and stick, no wiring necessary, or attach with enclosed hardware
- Records and displays to 9,999.9 hours
- Hour glass symbol appears and flashes on/off to indicate counting time
- Automatic roll over / Resolution 0.1 hour
- 100% epoxy encapsulated casing resists water
- No power required - sealed waterproof lifetime battery



**HL8065 47.40 L**



### ROBIC STOP WATCH

- Easy to use timer allows you to focus on the event or activity
- Includes Event-Lap/Split Lap Counter
- Ultra precise multi-mode stopwatch with memory recall and lap counter
- Lap, split or event timing
- Five memory recall
- Auto lap counter up to 99
- Auto lap/Split release
- 1st-5th place times
- Water resistant to 30 meters
- Break-Away safety lanyard
- Uses CR-2032 Lithium battery



**HL8100 35.99 L**



### SPORTECH MINI TACH **-HOLESHOT-**

The Sportech Mini-Tach is the ultimate tuning device! It accurately records up to 10,000 RPMs and also meters total engine run time. RPM is recorded as the engine runs; engine run time is displayed when the engine is off. This is the best way to determine proper sled gearing, and it's also an excellent way to monitor engine use for proper on-time maintenance. Mini-Tach will work on all 1 or 2 cylinder 4-stroke engines with electronic ignition. Installs in just minutes with no special tools or mechanical experience.



**770295 69.95 G**

### HOUR/TACH ADJUSTABLE METER

- Includes log book
- rack your service and settings
- Adjustable input and re-settable Max RPM
- Works on all gasoline engines
- No battery or ground wire required
- Easy installation
- 100% epoxy encapsulated cases are water resistant
- Record and display in increments of .01 hours up to 9,999.9 hours
- Hourglass symbols appear and flash on/off to indicate counting time
- Automatic roll-over



**WISeco**

**109000 36.95 G**

### HOUR METER

- Includes log book
- rack your service and settings
- Adjustable input and re-settable Max RPM
- Works on all gasoline engines
- No battery or ground wire required
- Easy installation

**WISeco**

**109002 36.95 G**



### INSTRUMENT STYLE BRACKET

- Fits standard Wiseco hour meter or tachometer

**WISeco**

**109001 9.95 G**





## POLYETHYLENE RIP-STOP TARPS

• 5 oz. polyethylene • Bright blue • 8 X 8 weave • Grommets every 3 feet • Waterproof • Tear proof

| PART #  | CUT SIZE |       |   |
|---------|----------|-------|---|
| BPT57   | 5 X 7    | 1.95  | G |
| BPT810  | 8 X 10   | 4.40  | G |
| BPT815  | 8 X 15   | 6.60  | G |
| BPT1012 | 10 X 12  | 6.55  | G |
| BPT1018 | 10 X 18  | 9.90  | G |
| BPT1212 | 12 X 12  | 7.90  | G |
| BPT1225 | 12 X 25  | 16.45 | G |
| BPT1530 | 15 X 30  | 24.70 | G |
| BPT1620 | 16 X 20  | 17.55 | G |
| BPT2030 | 20 X 30  | 32.95 | G |
| BPT2040 | 20 X 40  | 43.95 | G |

- apparel
- accessories
- towables
- body
- controls
- electrical
- driveline
- engine
- fuel & intake
- chemicals
- tie downs

- tools
- towing & loading

# MARINE



## BROWN/GREEN REVERSIBLE TARP

• 10X10 Weave • Brown on one side/Green on the other • Blends in with spring and fall colors • Features strong plastic reinforced corners for added strength

| PART #  | CUT SIZE |       |   |
|---------|----------|-------|---|
| EK57030 | 6 X 8    | 5.75  | G |
| EK57031 | 8 X 10   | 9.55  | G |
| EK57032 | 10 X 12  | 14.40 | G |
| EK57033 | 12 X 16  | 22.95 | G |
| EK57034 | 12 X 20  | 28.75 | G |
| EK57035 | 16 X 20  | 38.55 | G |
| EK57036 | 18 X 24  | 51.75 | G |

### HEAVY DUTY CAMO TARP

- 10 x 10 weave with reinforced corners
- Increased UV content for longer life
- Rust resistant grommets
- Lightweight and flexible easy storage



| PART #  | CUT SIZE |       |   |
|---------|----------|-------|---|
| EK57005 | 10 X 12  | 25.70 | G |

### HEAVY DUTY MESH TARP

The mesh design allows the air to flow through and works great for covering loads that need containment but not water repellency. The flapping we see with most tarps is drastically reduced with the mesh design.

Ideal for:

- Trailer covers
- Dump truck covers



| PART #  | CUT SIZE |       |   |
|---------|----------|-------|---|
| EK57056 | 6 X 8    | 29.45 | G |
| EK57057 | 8 X 10   | 42.70 | G |
| EK57058 | 10 X 12  | 58.80 | G |
| EK57059 | 12 X 16  | 86.75 | G |

## RATCHETING TIE DOWN WITH WEB CLAMP

Erickson's Strap Trap holds the excess web not being used by simply clamping it into the ratchet handle so it can't blow in the wind. the clamping mechanism is much like a mouse trap, lift the spring loaded clamp and place the folded webbing under the clamp, release the strap trap and you have trapped the excess web.

| SIZE     | MAX LOAD | SAFE WORKING LOAD | QTY    | MFG # | PART #  |         |
|----------|----------|-------------------|--------|-------|---------|---------|
| 1" x 15' | 1,500#   | 500#              | 1 pack | 31350 | EK31350 | 10.60 G |
| 1" x 8'  | 1,500#   | 500#              | 2 pack | 31351 | EK31351 | 16.75 G |
| 1" x 10' | 1,500#   | 500#              | 4 pack | 31352 | EK31352 | 33.10 G |



- apparel
- accessories
- towables
- body
- controls
- electrical
- driveline
- engine
- fuel & intake
- chemicals
- tie downs
- tools
- towing & loading

## ADJUSTABLE TARP STRAP

24" long • 6 per package

Adjustable tarp straps have heavy reinforced holes every 6" along the strap to hook back into or move the end hook to make it shorter.



**ERICKSON**

EK6724 11.75 pkg G

## TARP CLIP

Heavy duty nylon clip, sold each



**ERICKSON**

EK51029 2.45 EA G

## BLACK RUBBER TIE DOWNS

- Quick and easy, just hook and secure into place
- Extra heavy duty 3/4" flat rubber tie downs with heavy reinforced ends and heavy 2-1/2" steel hooks
- Maximum resistance to all weather conditions

**ERICKSON**



|         |     |      |   |
|---------|-----|------|---|
| LP13910 | 10" | 1.39 | L |
| LP13915 | 15" | 1.69 | L |
| LP13921 | 21" | 2.19 | L |
| LP13931 | 31" | 2.79 | L |
| LP13941 | 41" | 2.99 | L |

## BLACK RUBBER TARP STRAPS

These rubber bungee cords are a versatile tie down strap and are easily stored. These rubber straps have a 2" S-Hook on each end.

Package of 10 Includes:

- (4) - 9"
- (2) - 15"
- (2) - 21"
- (2) - 31"



**ERICKSON**

EK06610 14.45 pkg G

## FLAT BUNGEE CORDS

- A hardened metal wire form is placed in the center of the moulded polycarbonate hook - making it super strong
- Sold each

**ERICKSON**

|     |         |      |   |
|-----|---------|------|---|
| 12" | EK06912 | 2.90 | G |
| 18" | EK06918 | 3.15 | G |
| 24" | EK06924 | 3.25 | G |
| 30" | EK06930 | 3.45 | G |
| 36" | EK06936 | 3.60 | G |
| 42" | EK06942 | 3.85 | G |



## DELUXE BUNGEE CORDS

- Talk about quality! That's what the deluxe bungee is all about
- An Industrial grade bungee comes secured to a moulded polycarbonate hook with a hardened wire insert moulded in
- 3 sizes available in 3 colors

**ERICKSON**

|             |         |      |   |
|-------------|---------|------|---|
| 12", Red    | EK07012 | 2.55 | G |
| 24", Blue   | EK07024 | 3.10 | G |
| 36", Yellow | EK07036 | 3.55 | G |



## E-TRACK ADJUSTABLE TIRE STRAP

- For standard tires
- Sold each
- Yellow

**ERICKSON**



EK08314 42.75 ea G

## ADJUSTABLE TIRE STRAP W/RATCHET

- 10,000#
- Adjustable tire strap, 1 pack
- Yellow

**ERICKSON**



EK08522 46.60 ea G

## 10,000# ADJUSTABLE TIRE STRAP W/RATCHET



**ERICKSON**

EK58522 39.95 ea G





# TOWING & LOADING

# TOWING & LOADING

## TRAILER WINCHES

- Comfort grip handle
- Zinc plate finish
- High carbon steel gears
- Heavy duty rib reinforced frames
- Engineered to keep handle effort low for smooth and easy operation
- Drums drilled for winch strap installation
- Only winches that are shown to accommodate steel cable should be used with steel cable
- Cable keeper kits are included with the winches specifying steel cable
- Winches rated for steel cable have a larger drum hub to reduce or lessen the chance of kinking or fraying
- **NOTE:** FULTON Winches are **NOT** designed to be a human hoist and should never be operated when there are persons on or under the load being moved
- All Fulton winches are attractively boxed for display



| PART #                 | WEIGHT CAPACITY | GEAR RATIO | HANDLE LENGTH | STRAP SIZE                | STRAP INCLUDED     | MOUNTING HARDWARE | FINISH    |
|------------------------|-----------------|------------|---------------|---------------------------|--------------------|-------------------|-----------|
| <b>SINGLE SPEED F2</b> |                 |            |               |                           |                    |                   |           |
| 444091                 | 127.57 B        | 1600       | 4.1:1         | 2 Position 6", 7"         | 20' x 2" w/Hook    | YES               | Sharkskin |
| 444092                 | 170.42 B        | 2000       | 5.1:1         | 4 Position 6", 7", 8", 9" | 20' x 2" w/Hook    | YES               | Sharkskin |
| <b>TWO SPEED F2</b>    |                 |            |               |                           |                    |                   |           |
| 444093                 | 229.06 B        | 3200       | 5.1:1, 3.17:1 | 4 Position 6", 7", 8", 9" | 20' x 2" w/HD Hook | YES               | Sharkskin |

| PART #                     | WEIGHT CAPACITY | GEAR RATIO | HANDLE LENGTH | RATCHET TYPE | ROPE    | CABLE       | STRAP SIZE | STRAP BOLT SIZE | STRAP INCL.            |     |
|----------------------------|-----------------|------------|---------------|--------------|---------|-------------|------------|-----------------|------------------------|-----|
| <b>SINGLE SPEED FULTON</b> |                 |            |               |              |         |             |            |                 |                        |     |
| FT276                      | 40.96 E         | 600        | 3.1:1         | 6"           | TWO WAY | 36' x 1/4"  | N/A        | 15' x 2"        | 1/4" x 2-1/2" GRADE 5  | NO  |
| FT290                      | 41.92 E         | 900        | 3.1:1         | 7"           | TWO WAY | 36' x 1/4"  | N/A        | 15' x 2"        | 1/4" x 2-1/2" GRADE 5  | NO  |
| 444094                     | 54.75 B         | 900        | 3.1:1         | 7"           | TWO WAY | 36' x 1/4"  | N/A        | 15' x 2"        | 1/4" x 2-1/2" GRADE 5  | YES |
| 444095                     | 57.00 B         | 900        | 3.1:1         | 6"           | TWO WAY | 36' x 1/4"  | N/A        | 12' x 2"        | 1/4" x 2-1/2" GRADE 5  | YES |
| FT277                      | 48.22 E         | 1100       | 4.1:1         | 7"           | TWO WAY | 30' x 5/16" | N/A        | 20' x 2"        | 1/4" x 2-1/2" GRADE 5  | YES |
| 444096                     | 58.75 B         | 1100       | 4.1:1         | 7"           | TWO WAY | 30' x 5/16" | N/A        | 20' x 2"        | 1/4" x 2-1/2" GRADE 5  | NO  |
| FT278                      | 50.22 E         | 1300       | 4.1:1         | 8"           | TWO WAY | 30' x 5/16" | N/A        | 20' x 2"        | 1/4" x 2-1/2" GRADE 5  | NO  |
| 444097                     | 62.61 B         | 1300       | 4.1:1         | 8"           | TWO WAY | 30' x 5/16" | N/A        | 20' x 2"        | 1/4" x 2-1/2" GRADE 5  | YES |
| 444098                     | 96.28 B         | 1400       | 4.1:1         | 8"           | TWO WAY | N/A         | N/A        | 20' x 2"        | 5/16" x 2-1/2" GRADE 5 | YES |
| FT280                      | 53.30 E         | 1500       | 4.1:1         | 8"           | TWO WAY | 20' x 5/16" | N/A        | 20' x 2"        | 1/4" x 2-1/2" GRADE 5  | NO  |
| 444099                     | 68.39 B         | 1500       | 4.1:1         | 8"           | TWO WAY | 20' x 5/16" | N/A        | 20' x 2"        | 1/4" x 2-1/2" GRADE 5  | YES |
| 444100                     | 73.18 B         | 1600       | 5.1:1         | 9"           | TWO WAY | 20' x 7/16" | N/A        | 20' x 2"        | 3/8" x 2-3/4" GRADE 5  | NO  |
| FT284                      | 78.48 E         | 1800       | 5.1:1         | 10"          | TWO WAY | 20' x 7/16" | N/A        | 20' x 2"        | 3/8" x 2-3/4" GRADE 5  | NO  |
| FT274                      | 89.22 E         | 1800       | 5.1:1         | 10"          | TWO WAY | 20' x 7/16" | N/A        | 20' x 2"        | 3/8" x 2-3/4" GRADE 5  | YES |
| FT304                      | 117.57 E        | 1800       | 5.1:1         | 10"          | TWO WAY | N/A         | N/A        | 20' x 2"        | 3/8" x 2-3/4" GRADE 5  | YES |

| PART #                  | WEIGHT CAPACITY | GEAR RATIO | HANDLE LENGTH  | RATCHET TYPE | ROPE               | CABLE | STRAP SIZE   | STRAP BOLT SIZE | STRAP INCL. | HAND BRAKE | HUB SIZE  |        |
|-------------------------|-----------------|------------|----------------|--------------|--------------------|-------|--------------|-----------------|-------------|------------|-----------|--------|
| <b>TWO SPEED FULTON</b> |                 |            |                |              |                    |       |              |                 |             |            |           |        |
| 444103                  | 145.34 B        | 2000       | 4.1:1 & 9.8:1  | 10"          | TWO WAY W/ NEUTRAL | N/A   | N/A          | 20' x 2"        | N/A         | YES        | 1619-01   | 1"     |
| FT288                   | 146.56 E        | 2600       | 5.1:1 & 12.2:1 | 10"          | TWO WAY W/ NEUTRAL | N/A   | N/A          | 20' x 2"        | N/A         | NO         | 1619-01   | 1"     |
| 444106                  | 153.01 B        | 2600       | 5.1:1 & 12.2:1 | 10"          | TWO WAY W/ NEUTRAL | N/A   | 100' x 7/32" | N/A             | CABLE ONLY  | N/A        | 1619-01   | 1-3/4" |
| 444107                  | 193.95 B        | 3200       | 5.1:1 & 12.2:1 | 10"          | TWO WAY W/ NEUTRAL | N/A   | 100' x 7/32" | N/A             | CABLE ONLY  | N/A        | 1619-01   | 1-3/4" |
| FT289                   | 207.21 E        | 3200       | 5.1:1 & 12.2:1 | 10"          | TWO WAY W/ NEUTRAL | N/A   | 100' x 7/32" | N/A             | CABLE ONLY  | N/A        | INSTALLED | 1-3/4" |
| 444108                  | 322.98 B        | 3700       | 5.1:1 & 12.2:1 | 10"          | TWO WAY W/ NEUTRAL | N/A   | 90' x 7/32"  | N/A             | CABLE ONLY  | N/A        | INCLUDED  | 1-3/4" |

## FULTON

### BRAKE WINCHES

Fulton brand K-Series self-activating automatic brake winches hold the load securely when the crank handle is released. Typical applications include boat lifts, grain augers, manual fork lifts, retractable swing keels, dumpster lid lifts, and manual hoists. Drum hubs are 10 times the recommended cable size to maximize cable life. The KX series offer plated gear covers for improved gear train protection and a dual ratchet system.



| PART # | 1ST LAYER LBS | FULL DRUM LBS | DIAMETER | DRUM STORAGE | TEST STRENGTH LBS | GEAR RATIO | HANDLE LENGTH | DRUM HUB DIAMETER | CABLE INCLUDED |    |
|--------|---------------|---------------|----------|--------------|-------------------|------------|---------------|-------------------|----------------|----|
| 444110 | 119.45        | B 1000        | 500      | 7/32"        | 50'               | 5600       | 4.1:1         | 11"               | 2-1/4"         | NO |
| 444111 | 174.02        | B 1500        | 700      | 1/4"         | 70'               | 7000       | 5.1:1         | 11"               | 2-1/2"         | NO |
| 444112 | 280.34        | B 2500        | 1500     | 5/16"        | 70'               | 9800       | 15.8:1        | 11"               | 3-1/8"         | NO |

### HAND WINCHES

- Includes hook
- Nylon strap attached
- Winch does free wheel
- Zinc plated
- 2 sizes
- Cranks in and out under load
- Full color retail package



| PART # | LOAD CAPACITY | GEAR RATIO | HUB SIZE | HANDLE LENGTH |       |
|--------|---------------|------------|----------|---------------|-------|
| BY800  | 33.95         | G 800#     | 4.1:1    | 1-1/2" x 26'  | 7"    |
| BY820  | 67.95         | E 2000#    | 9.8:1    | 2" x 20'      | 9.84" |

### XLT SERIES CUSTOMIZED WINCHES

#### 20' WINCH STRAP W/HOOK INCLUDED

- 1400# capacity - 4.1:1 gear ratio
- Zinc plated finish on winch
- High carbon steel gears
- 8" comfort grip handle
- Two way ratchet
- Polypropylene plastic shell
- 20' x 2" drum storage strap
- Black only
- Boxed

| PART # | LOAD CAPACITY | GEAR RATIO | HUB SIZE | HANDLE LENGTH | RATCHET TYPE | HAND BRAKE | REPLACEMENT HANDLE # |
|--------|---------------|------------|----------|---------------|--------------|------------|----------------------|
| -----  | 1400#         | 4.1:1      | 3/4"     | 8"            | Two Way      | No         | FT6302 16.89 E       |
| FT304  | 117.57        | E 1800#    | 5.1:1    | 7/8"          | 10"          | Two Way    | -----                |



### TRAILER WINCHES WITH STRAP ATTACHED

| PART #        | DESCRIPTION         |
|---------------|---------------------|
| FT272 81.93 E | Same as FT280 1500# |
| FT274 89.22 E | Same as FT284 1800# |



- accessories
- towables
- body
- controls
- electrical
- driveline
- engine
- fuel & intake
- chemicals
- tie downs
- tools
- towing & loading

# MARINE

# TOWING & LOADING



## MARINE SLIDES TRAILER BUNK SLIDES

Makes launching your boat or watercraft easy, slides effortlessly off bunks and into the water.

- The new unique profile provides extra cushioning between the boat and trailer bunks
- Washout channels flush sand and debris off of the slides and away from the hull
- Safer unloading and loading because of reduced friction and stress by 400% on the trailer cranking mechanisms, ropes and hull bow hooks
- Allows you to unload and load your boat or watercraft in shallower water
- Fast and simple installation for both horizontal and vertical bunks
- Made from a low-friction composite which is impervious to sun, weather and salt water
- Excellent for use on work stations, lifts, boat and watercraft dollies

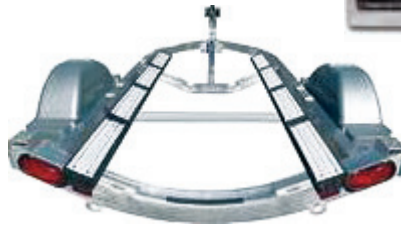

| PART#   | MFG # | DESCRIPTION                 |       |   |
|---------|-------|-----------------------------|-------|---|
| PD23010 | 23010 | 10 Pack - 3" x 15" Black    | 34.95 | G |
| PD23011 | 23011 | 10 Pack - 3" x 15" White    | 34.95 | G |
| 362015  | 23013 | 10 Pack - 3" x 15" Yellow   | 34.95 | D |
| 362016  | 23030 | 10 Pack - 1.5" x 15" Black  | 19.95 | B |
| 362017  | 23031 | 10 Pack - 1.5" x 15" White  | 19.95 | B |
| 362018  | 23033 | 10 Pack - 1.5" x 15" Yellow | 19.95 | B |



## BUNK WRAP II RETAIL TRAILER BUNK WRAPS

Renew Your Old Shaggy Carpeted Bunks with a Permanent Solution!

- Reduce the spread of invasive species.
- Eliminate electrolysis breakdown on aluminum.
- Wraps directly over carpet or on bare wood!
- Slot fastening for wrinkle-free temp adjustment.
- Great for trailers and boat lifts!
- Made with proprietary High-Impact Glide Guard technology plastic.
- Material will not wear, crack, chip or fade.
- This is a permanent solution, GUARANTEED FOR LIFE!



| PART # | MFG #    | DESCRIPTION  |       |   |
|--------|----------|--|-------|---|
| 362011 | 23050    | 2x4 Gray on 16' Roll w/4 Endcaps & Stainless Hardware  | 49.99 | D |
| 362013 | 23052    | 2x6 Gray on 16' Roll w/4 Endcaps & Stainless Hardware  | 64.95 | D |
| 362012 | 23050-BK | 2x4 Black on 16' Roll w/4 Endcaps & Stainless Hardware | 49.99 | D |
| 362014 | 23052-BK | 2x6 Black on 16' Roll w/4 Endcaps & Stainless Hardware | 64.95 | D |



## SLYDZ-ON SPRAY-ON BUNK LUBRICANT

Makes launching your boat or watercraft easy, slides effortlessly off bunks and into the water.

- Reduces cranking torque required by as much as 275%
- Safer unloading and loading by dramatically reducing stress on the trailer crank mechanisms, ropes and hull bow hooks
- Allows you to unload and load your boat or watercraft in shallower water
- Fast and simple application for both horizontal and vertical bunks
- Made from a unique blend of anti-friction compounds
- Excellent for use on work stations, boat lifts and watercraft dollies
- Comes in 1 pint (16 fl. oz.) easy-to-use spray bottle and is applied directly to carpeted bunks



| PART #  | MFG # | DESCRIPTION             |       |   |
|---------|-------|-------------------------|-------|---|
| PD23200 | 23200 | 16 fl. oz. Spray Bottle | 14.95 | G |

- accessories
- towables
- body
- controls
- electrical
- driveline
- engine
- fuel & intake
- chemicals
- tie downs
- tools
- towing & loading

MARINE

## WINCH STRAPS

- Winch straps are 2" wide and have an overall tensile strength of 5000#
- Easy to install and no more tangling in the drum!
- Each strap is skin packaged and comes with a heavy duty forged latch hook

| PART #  | PRICE | SIZE       | DESCRIPTION      |
|---------|-------|------------|------------------|
| LR50465 | 11.89 | G 2" x 15' | 5000# w/loop end |
| LR50470 | 14.01 | G 2" x 20' | 5000# w/loop end |
| LR50472 | 15.48 | G 2" x 20' | 5000# w/tail     |
| LR50475 | 15.15 | G 2" x 25' | 5000# w/loop end |



## HAND WINCH STRAPS WITH CASTED HOOK

- Cast hook with safety hatch
- Bolt on
- Display packaged

| PART #  | PRICE | SIZE       | STRENGTH | COLOR |
|---------|-------|------------|----------|-------|
| EK06404 | 16.30 | G 2" x 25' | 3300#    | Black |
| EK06410 | 23.95 | G 2" x 20' | 10,000#  | Blue  |



## WINCH STRAP & HOOK

2" x 20' nylon web winch strap with loop end



**FT207 15.00 E**

## PERSONAL WATERCRAFT WINCH STRAP

- 2" x 12' 1,800
- Includes loop nylon strap with hook

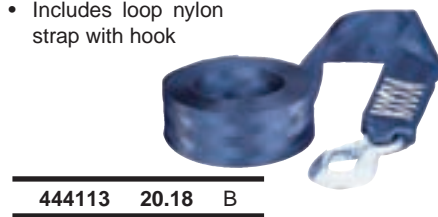

**444113 20.18 B**

## HEAVY DUTY WINCH STRAP AND HOOK

- 2" x 20' 10,000 lb minimum breaking strength
- 4,000 lb max working load

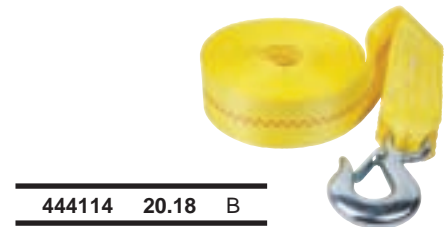

**444114 20.18 B**

## WINCH CABLES

- Galvanized steel 7 x 9 aircraft cable is made to handle the heavy loads
- Each cable is fitted with a heavy duty galvanized latch hook, pull proof loop and a fastener end for replacement use on Powerwinch, DL, Superwinch and other quality power winches
- Also great for hand crank winches

| SIZE        | STRENGTH | PART #  | PRICE | SIZE |
|-------------|----------|---------|-------|------|
| 5/32" x 25' | 2800#    | LR59378 | 18.00 | G    |
| 3/16" x 20' | 4200#    | LR59379 | 20.16 | G    |
| 1/8" x 20'  | 2000#    | LR59380 | 14.35 | G    |
| 3/16" x 25' | 4200#    | LR59385 | 20.09 | G    |
| 3/16" x 50' | 4200#    | LR59390 | 31.07 | G    |
| 7/32" x 25' | 5600#    | LR59395 | 23.80 | G    |
| 7/32" x 50' | 5600#    | LR59400 | 33.09 | G    |



## SNAP HOOK

- Forged steel with tensile strength of 7500#
- Sold each (bulk)



**CS16795 7.95 G**



## SNAP HOOKS

- Replace your worn out hook with a new zinc plated forged latch hook
- Skin packaged each

| PART #  | PRICE | SIZE | STRENGTH |
|---------|-------|------|----------|
| LR50640 | 5.55  | G    | 7000#    |
| LR50645 | 10.44 | G    | 7500#    |
| LR50641 | 11.30 | G    | 12,000#  |



## WINCH HOOK & CABLE

- 3/16" x 25' galvanized cable with attached snap hook
- 4200# nominal strength



**FT325 21.30 E**



## BOW SAFETY CHAIN

- Safety chain connects the boat to the bow stand of the trailer
- 3/16" x 15-1/2"
- Packaged each

**LR81201 5.38 G**



accessories  
towables  
body  
controls  
electrical  
driveline  
engine  
fuel & intake  
chemicals  
tie downs  
tools  
towing & loading

MARINE

# TOWING & LOADING

## ROLLER BRACKET ASSEMBLIES

PRE-ASSEMBLED FOR EASY INSTALLATION

- Strong hot-dipped galvanized brackets hold shock-absorbing rollers to give proper keel support

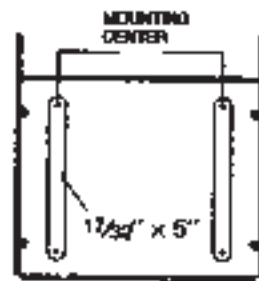

1 7/32" x 5" slot for verticle adjustment.  
Attach with 1/2" or 7/16" bolts.

### BLACK RUBBER

| PART #  | ROLLER           | SHAFT | MOUNTING CENTER |
|---------|------------------|-------|-----------------|
| CS10400 | 32.25 G 4" Spool | 5/8"  | 2"              |
| CS10401 | 36.45 G 5" Keel  | 5/8"  | 3"              |
| CS10403 | 53.55 G 8" Keel  | 5/8"  | 6"              |
| CS10404 | 61.25 G 10" Keel | 5/8"  | 8"              |
| CS10405 | 72.25 G 12" Keel | 5/8"  | 10"             |

### YELLOW RUBBER

|         |                  |      |     |
|---------|------------------|------|-----|
| CS10451 | 43.35 G 5" Spool | 5/8" | 3"  |
| CS10453 | 65.95 G 8" Keel  | 5/8" | 6"  |
| CS10455 | 79.00 G 12" Keel | 5/8" | 10" |

## WOBBLE ROLLER RETAINER RINGS

- Packs of 2 rings with washers
- Used to hold wobble rollers



PART # CS10980 9.45 G  
Washer SAE 1-1/8"

## STATIONARY KEEL ROLLER BRACKETS

- Mount on tongue or frame for keel support
- No mounting hardware included
- Sold each (bulk)

GALVANIZED



For Frame  
2-3/4" Hole Centered  
4" Roller

PART # CS32100  
30.95 G



For 2" Wide Tongue  
2-3/4" Hole Centered  
4" Roller

PART # CS32110  
30.00 G



For 3" Wide Tongue  
3-1/2" Hole Centered  
5" Roller

PART # CS32150  
30.75 G

## ADJUSTABLE TONGUE KEEL ROLLER BRACKETS

- Offset brackets mount on tongue to hold roller for keel support
- Assembled
- Hardware included
- Display packaged
- Offset: 1"
- Length: 11-1/2"
- 3/8" diameter bolts



2 SIZES

| PART #  | DESCRIPTION                 |
|---------|-----------------------------|
| CS32003 | 41.30 G For 3" Tongue       |
| CS32005 | 40.95 G For 2" Tongue       |
| CS32004 | 14.25 G Brackets Only, Pair |

## SPRING LATCH WELD ON

- 5/8" x 4" (overall) zinc plated pin
- 2-1/2" loop handle
- Stainless steel spring and a 2" x 1-1/2" x 1-1/4" steel housing
- Retaining pin extends 7/8" past housing when closed and 7/32" when open

PART # BY2598  
7.95 H  
Sold Each



## TILT LATCHES

- Designed for tilt style trailers and utility trailer gates
- Weld or bolt to tongue
- Plain base of 7 ga. steel
- Handle, spring, and plunger are zinc plated
- Sold each (bulk)

| PART # | DESCRIPTION          | MOUNTING        |
|--------|----------------------|-----------------|
| BY382  | 7.95 H 1/4" Four Way | Bolt On/Weld On |



## ANGLE "L" BRACKETS

- Use as top mounted roller bracket or as tie down
- Heavy 7 gauge steel, hot dipped galvanized for long life
- Holds 1/2" roller shaft
- 2" x 2-1/2"
- Sold in pairs



GALVANIZED

CS10211 9.35 G

## BLACK BOAT TRAILER ROLLERS ROLLERS ARE OEM REPLACEMENTS FOR MANY TRAILERS

### HD KEEL ROLLERS



| PART # | LENGTH      | DIA.   | SHAFT |
|--------|-------------|--------|-------|
| 690098 | 19.95 G 12" | 3-1/2" | 5/8"  |
| 690096 | 16.95 G 10" | 3-1/2" | 5/8"  |
| 690088 | 14.95 G 8"  | 3-1/2" | 5/8"  |

### SUPER HD KEEL ROLLERS



| PART # | LENGTH     | DIA.   | SHAFT |
|--------|------------|--------|-------|
| 690055 | 18.95 G 8" | 3-1/2" | 5/8"  |
| 690053 | 14.95 G 5" | 3"     | 5/8"  |

### SPOOL ROLLERS



| PART # | LENGTH    | DIA. | SHAFT |
|--------|-----------|------|-------|
| 690075 | 7.95 G 8" | 3"   | 5/8"  |
| 690046 | 6.95 G 5" | 3"   | 5/8"  |
| 690045 | 6.95 G 5" | 3"   | 1/2"  |
| 690044 | 5.95 G 4" | 3"   | 1/2"  |

### MOLDED SIDE GUIDE ROLLERS



| PART # | LENGTH      | DIA.   | SHAFT |
|--------|-------------|--------|-------|
| 690128 | 14.95 G 12" | 2-1/2" | 5/8"  |
| 690126 | 7.95 G 9"   | 2"     | 1/2"  |

### MOLDED Y BOW STOPS



| PART # | SIZE         | SPAN |
|--------|--------------|------|
| 690032 | 13.95 G 4x4" | 7"   |
| 690030 | 11.95 G 3x3" | 6"   |
| 690020 | 11.95 G 2x2" | 4"   |

### BOW ROLLERS



| PART # | SIZE        | SHAFT |
|--------|-------------|-------|
| 690036 | 5.95 G 4"   | 1/2"  |
| 690035 | 3.80 G 2x2" | 4"    |

### ROCKER & RIB ROLLERS

| RIBBED PART # | LENGTH    | DIA.   | SHAFT |
|---------------|-----------|--------|-------|
| 690158        | 9.95 G 3" | 5"     | 5/8"  |
| 690155        | 9.95 G 3" | 5"     | 3/4"  |
| 690154        | 9.95 G 3" | 4-3/8" | 5/8"  |
| 690153        | 9.95 G 3" | 4-3/8" | 3/4"  |

| PLAIN PART # | DIA.           | SHAFT   |
|--------------|----------------|---------|
| 690150       | 13.95 G 4-3/8" | 4" 3/4" |



### END CAPS FOR BOW, SPOOL, KEEL AND SIDE GUIDE ROLLERS

| PART # | LENGTH        | DIA.   | SHAFT |
|--------|---------------|--------|-------|
| 690168 | 3.95 G 1-1/4" | 3-1/2" | 5/8"  |
| 690167 | 2.95 G 1-1/4" | 3"     | 1/2"  |
| 690165 | 2.95 G 1-3/4" | 2-1/2" | 5/8"  |
| 690160 | 2.95 G 1-3/4" | 2-1/2" | 1/2"  |



## THERMAL PLASTIC RUBBER (TPR) ROLLERS

### TPR HEAVY DUTY KEEL ROLLERS



| PART # | LENGTH      | DIA.   | SHAFT |
|--------|-------------|--------|-------|
| 690212 | 22.95 G 12" | 3-1/2" | 5/8"  |
| 690208 | 19.95 G 8"  | 3-1/2" | 5/8"  |

### TPR SPOOL ROLLERS



| PART # | LENGTH    | DIA. | SHAFT |
|--------|-----------|------|-------|
| 690205 | 9.95 G 5" | 3"   | 5/8"  |
| 690204 | 8.95 G 4" | 3"   | 5/8"  |
| 690202 | 8.95 G 4" | 3"   | 1/2"  |

### TPR BOW ROLLERS



| PART # | LENGTH    | DIA.   | SHAFT |
|--------|-----------|--------|-------|
| 690224 | 5.95 G 4" | 3-1/2" | 1/2"  |
| 690222 | 4.95 G 3" | 3"     | 1/2"  |

### TPR RIB ROLLERS



| PART # | LENGTH    | DIA. | SHAFT |
|--------|-----------|------|-------|
| 690218 | 9.95 G 5" | 3"   | 1"    |
| 690216 | 9.95 G 5" | 3"   | 3/4"  |

### TPR BOW BELLS



3-1/2"

| PART # | SIZE        |
|--------|-------------|
| 690210 | 4.95 G 1/2" |

### TPR END CAPS FOR BOW, SPOOL AND KEEL ROLLERS



3-1/2" x 1-1/4"

| PART # | SIZE        |
|--------|-------------|
| 690211 | 2.95 G 1/2" |

### TPR KEEL PADS



12" Pad, Side Hole

| PART # | SIZE   |
|--------|--------|
| 690200 | 8.15 G |

accessories

towables

body

controls

electrical

driveline

engine

fuel & intake

chemicals

tie downs

tools

towing & loading

MARINE

# TOWING & LOADING

ON THIS PAGE ARE THE NECESSARY PARTS TO MAKE YOUR OWN CUSTOM ROLLER KIT. ALL YOU DO IS PICK A BRACKET, A SHAFT AND TWO PAL NUTS. FIND THE CORRECT SIZE ROLLER ON THE FOLLOWING PAGES AND ASSEMBLE THE PERFECT SIZE.

accessories  
towables  
body  
controls  
electrical  
driveline  
engine  
fuel & intake  
chemicals  
tie downs  
tools  
towing & loading

## ONE-PIECE KEEL ROLLER BRACKETS



- Heavy duty one piece brackets
- which mount to cross member to hold roller
- For 5/8" shaft with 17/32" x 5" lot
- for adjustment
- 11 gauge steel
- Galvanized finish

| PART #  | ROLLER      | SLOT CNTR. |
|---------|-------------|------------|
| CS10300 | 14.20 G 4"  | 2"         |
| CS10301 | 14.95 G 5"  | 3"         |
| CS10303 | 19.40 G 8"  | 6"         |
| CS10304 | 20.55 G 10" | 8"         |
| CS10305 | 22.10 G 12" | 10"        |

## SPLIT TWO-PIECE KEEL ROLLER BRACKETS

- Two piece brackets to accommodate any length roller
- 17/32" x 5" slot for vertical
- adjustment
- 11 gauge steel
- Zinc plated - 5/8" shaft
- Sold in pairs only



|        |         |       |   |
|--------|---------|-------|---|
| PART # | CS10500 | 15.70 | G |
|--------|---------|-------|---|

## ZINC PLATED ROLLER SHAFTS

- Sold each (bulk)



| PART #  | LENGTH | DIA.         |
|---------|--------|--------------|
| CS10700 | 4.81 G | 5-1/4" 1/2"  |
| CS10701 | 5.01 G | 6-1/4" 1/2"  |
| CS10704 | 1.38 H | 4-5/8" 1/2"  |
| CS10705 | 8.95 G | 12-3/4" 1/2" |
| CS10721 | 1.80 H | 5-1/4" 5/8"  |
| CS10722 | 6.17 G | 6-1/4" 5/8"  |
| CS10725 | 7.67 G | 9-1/4" 5/8"  |
| CS10726 | 7.77 G | 11-1/8" 5/8" |
| CS10727 | 9.24 G | 13-1/2" 5/8" |

## PAL NUTS

- Zinc plated push on to secure rollers to shaft
- Push on metal cap
- 2 sizes
- Sold each (bulk)



| PART # | SIZE        |
|--------|-------------|
| 690188 | 0.45 E 1/2" |
| 690190 | 0.50 G 5/8" |

## VERTICAL BUNK BRACKETS

- Galvanized bracket will adjust vertically to hold 2" bunks on edge
- Width: 2", double slots



8-1/2" long

| PART #  | EACH SLOT             |
|---------|-----------------------|
| CS10604 | 8.20 G 7/16" x 2-1/2" |

## ADJUSTABLE BUNK BRACKETS

- Zinc plated
- Heavy gauge steel brackets mount 2" bunks on edge
- Slotted vertical adjustment to standard or deep V-hulls
- Width: 2"
- Slot 17/32"

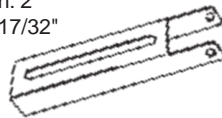

| PART #  | LENGTH        | EACH SLOT       |
|---------|---------------|-----------------|
| CS10600 | 7.55 9-1/2"   | 7/16" x 6"      |
| CS10601 | 10.80 12-5/8" | 17/32" x 9-1/8" |

## BOLSTER/SWIVEL BRACKET ASSEMBLIES

- 2-1/2" width
- Bunk mount holes 2-1/2" on center



| PART #  | ASSEM. LENGTH | SLOT   | CTN |
|---------|---------------|--------|-----|
| CS10000 | 11.95 9"      | 2-3/4" | 48  |
| CS10001 | 13.95 11"     | 3-3/4" | 36  |
| CS10002 | 15.95 13"     | 4-3/4" | 36  |

## STATIONARY BUNK BRACKETS

- Zinc Plated
- U-brackets mount on top of trailer cross members to hold 2" x 4" bunks on edge
- Made of 10 gauge steel

1-1/2" wide



| PART #  | HEIGHT | BOARD SIZE   |
|---------|--------|--------------|
| CS28104 | 3.25 G | 2-1/4" 2 x 4 |

## ROLLER BUNK MOUNTING BRACKET

- Galvanized swivel top bracket provides vertical and tilting adjustment for roller bunks
- Mount on trailer cross member
- Non-slip dimples for security
- Pair of bunks requires at least 4 brackets
- Slots: 17/32" x 3-3/4"
- Width: 2-1/2"
- Assembled length: 11"



| PART #  | DESCRIPTION                     |
|---------|---------------------------------|
| CS10003 | 14.60 G Assembled bracket, bulk |
| CS10101 | 9.25 G Bracket only             |



## TAILLIGHT BRACKETS

- Galvanized brackets to hold trailer side rail
- Punched to hold lights and wiring

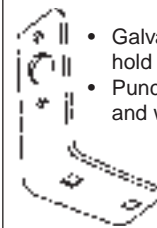

|         |        |
|---------|--------|
| CS26057 | 3.15 G |
|---------|--------|

## BOLSTER SUPPORT BRACKETS

- Zinc plated
- Heavy 11 gauge steel with double slot for vertical adjustment
- Non-slip dimples for better hold
- Width: 2-1/2"
- Slot Width: 17/32"



| PART #  | LENGTH  | EACH SLOT  |
|---------|---------|------------|
| CS10100 | 6.50 G  | 9" 2-3/4"  |
| CS10101 | 9.25 G  | 11" 3-3/4" |
| CS10102 | 10.55 G | 13" 4-3/4" |

## SWIVEL/BOLSTER BRACKET



TO CREATE THE ABOVE ORDER ONE OF EACH AND SIMPLY BOLT THE ANGLE BRACKET TO THE SUPPORT BRACKET.



## SWIVEL ANGLE BRACKET

- Zinc plated
- For use with bolster brackets to secure tie downs

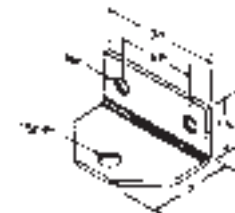

| PART #  | HOLE CENTERS            |
|---------|-------------------------|
| CS10200 | 2.20 G 2-1/2" on center |
| CS10201 | 2.20 G 2" on center     |

MARINE





## BOAT GUIDES TRAILER POSITIONERS

For quick, easy boat centering, in and out of the water • Ideal for boat lifts and trailers  
 • Simple design - no moving parts to corrode, hang up or damage your boat • Fully adjustable for all popular trailers • Easy installation - no drilling required • Non-marring white finish for high visibility • Extra long mounting hardware fits all popular trailers and boat lifts • Trailer lights can be kept out of the water by attaching boat guides

Boat Guides' Extra Height Improves  
 Visability When Launching or Backing Up

Easy On and  
 Off the Trailer



| PART #       | DESCRIPTION   |
|--------------|---|
| FT158 98.89  | E 44" Boat Guides with Hardware - Boxed for Display |
| FT160 104.63 | E 50" Boat Guides with Hardware - Boxed for Display |



## ROLLER BUNKS

- Change bunk trailers to roller type
- Channel-style bunks pre-assembled
- Pair supports up to 1,500 lbs.
- Made of heavy gauge galvanized steel for long lasting rust protection
- Can be mounted on existing flat bunkboards, or used with our special mounting brackets (sold separately) for height and angle adjustment
- No hardware is included
- Channel: 2-1/8" W x 2-1/2" H



| PART #         | LENGTH | ROLLERS |
|----------------|--------|---------|
| CS27700 184.95 | G 4'   | 5       |
| CS27710 219.95 | G 5'   | 6       |

## HEAVY DUTY CARPETED BUNK BOARDS

- Marine grade 2" X 4" bunks covered with top quality, weather-resistant marine carpet (black) to protect hulls from scratching when launching, loading or trailering
- Long-lasting black carpet has minimal water retention, durable backing

| PART #        | LENGTH  |
|---------------|---------|
| CS27800 26.90 | G 3 Ft. |
| CS27810 40.45 | G 4 Ft. |
| CS27820 54.00 | G 5 Ft. |



• Sold in pairs



## REPLACEMENT CARPET

- Deluxe, high quality, weather-resistant carpet renews trailer bunk appearance and protects boats from scratches
- Durable backing with minimal water retention
- Width of 10" will completely surround 2" X 4" bunk
- Black only



|               |                |       |
|---------------|----------------|-------|
| CS11330 21.95 | G 11" x 12 Ft. | Boxed |
|---------------|----------------|-------|

**MOST TRAILER MANUFACTURERS USE GRADE 5 SCREWS AND BOLTS FOR MAXIMUM SAFETY AND SECURITY. GRADE 5 HARDWARE HAS A HIGHER TENSILE STRENGTH THAN THE GRADE 2 HARDWARE USUALLY FOUND IN HARDWARE STORES.**

### HEX HEAD BOLTS

- Packs of 4 bolts, washers and nuts
- Zinc plated steel, grade 5
- Used to mount tongue to trailer frame



| PART #       | SIZE              |
|--------------|-------------------|
| CS10921 0.99 | J 7/16" - 14 x 1" |

### HEX HEAD BOLTS

- Packs of 4 bolts, washers and nuts
- Zinc plated steel, grade 5
- Can be used to mount brackets, coupler and winch stands



| PART #       | SIZE              |
|--------------|-------------------|
| CS11035 1.50 | AD 3/8" - 16 x 3" |

### #14 PAN HEAD PHILLIPS TAPPING SCREWS

- Packs of 8 screws
- Usually used to attach vertical or horizontal wooden bunks to bunk brackets



| PART #       | SIZE        |
|--------------|-------------|
| CS11006 0.99 | J 14 x 3/4" |

### 3/8" - 16 SLOTTED TRUSS HEAD BOLTS

- Display packages of 4 bolts, washers and nuts
- Zinc plated steel, grade 2
- Can be used to mount fenders to fender brackets



| PART #       | SIZE               |
|--------------|--------------------|
| CS10941 3.75 | J 3/8" - 16 x 3/4" |



### PYRAMIDAL TYPE WASHERS

- Packs of 4 zinc plated star-shaped pyramidal type washers used with U-bolts for heavy duty applications
- Gripping teeth have high holding strength and will withstand extreme torques



| PART #       | SIZE    |
|--------------|---------|
| CS10806 2.40 | G 7/16" |
| CS10805 2.40 | G 3/8"  |

- accessories
- towables
- body
- controls
- electrical
- driveline
- engine
- fuel & intake
- chemicals
- tie downs
- tools
- towing & loading

MARINE

# TOWING & LOADING

## BUNK BOARD GUIDE-ON BLACK CARPET INSTALLED

Carpeted bunkboards provide proper center loading in wind or side current conditions • 2" x 4" x 5 Ft. boards tilt and are covered with high grade marine carpet • Distance between galvanized upright posts can be adjusted to fit trailer • Can be mounted on top of frame for extra height • Complete in display box • Height: 21" • Adjust: out to 13" each side • Fits: Frame up to 3" W x 4-1/4" H • Tube: 1-1/2" sq. 16 ga. • Matl: Pre-galvanized steel • Angle: 75°

**CS27600 182.95 G Sold Per Pair Boxed**

**FOR BOTH STYLES**  
Use kit #**CS11416** longer u-bolts for frames up to 3" x 5-1/4"  
Use kit #**CS27630** for raised mounting of tail lights



## SHORT BUNK STYLE BOAT GUIDE-ON BLACK CARPET INSTALLED

Same solid construction as our larger model • Bunk is 24" long, covered with deluxe marine carpet, and mounted with an extra strong adjustable bracket • Can be mounted on top of frame for extra height • Complete in display box • Height: 21" • Adjust: out to 13" each side • Fits: Frame up to 3" W x 4-1/4" H • Tube: 1-1/2" sq. 16 ga. Matl: Pre-galvanized steel • Angle: 75°

**CS27660 159.95 G Sold Per Pair Boxed**



## JON BOAT FRONT SUPPORT BUNK

### BLACK CARPET INSTALLED

Carpeted 2" x 24" bunk cushions and supports front of jon boat or other flat bottom boat • Adjusts from 5-1/2" to 8" above tongue • Place on tongue at proper length for boat • Brackets are hot dipped galvanized • Complete with mounting hardware for 2" or 3" tongue



**CS27850 56.15 G Sold Per Pair Boxed**

## LONGER U-BOLT KIT

### FOR FRAMES UP TO 3" WIDE X 5-1/4" HEIGHT

- Longer u-bolts to mount all styles of boat guides on taller trailer frames up to 5-1/4" in height
- Leg length is 6" with thread length of 2"
- 5' bunkboard style guide-on requires 2 sets, all other guide-ons require 1 set



**CS11416 19.95 G Sold Per Kit Set of 4 U-bolts**

## ROLLER GUIDE-ON

### ROLLERS ALREADY PRE-ASSEMBLED TO POSTS

Makes boat loading easier • Galvanized posts are pre-assembled with 9" roller and end caps • Can be mounted on top of frame for extra height • Complete in display box • Height: 21" • Adjust: out to 13" each side • Fits: frame up to 3" W x 4-1/4" H • Post: 1-1/2" sq. 16 ga. • Matl: pre-galvanized steel • Angle: 90°

**PART # CS27610 153.25 G Sold Per Pair**



### REPLACEMENT PARTS

| PART #  | DESCRIPTION    | MEASUREMENTS   |
|---------|----------------|----------------|
| 690126  | 7.95 G Roller  | 2" x 9"        |
| 690160  | 2.95 G End Cap | 2" x 1-3/4"    |
| CS10705 | 8.95 G Shaft   | 1/2" x 12-3/4" |
| 690188  | 0.45 E Cap Nut | 1/2"           |



## GUIDE-ON LIGHT BRACKETS

### FOR 40" AND 60" POST STYLE

- Mounts lights out from PVC post approx. 7-1/2"
- Includes 2 formed galvanized brackets, 2 pieces of color coded 3-conductor bonded wire, 8 ft. length each, 4 terminals and 4 butt connectors plus hardware for mounting to PVC posts (does not include lights)



**CS27650 42.40 G Sold Per Kit**

### FOR BUNKBOARD, SHORT BUNK, AND ROLLER STYLE

- Mount tail lights high and dry
- Includes 2 2-3/4" x 6" galvanized brackets plus hardware for mounting to pre-punched boat guide-on upright posts (does not include lights or wiring)



**CS27630 22.05 G Sold Per Kit**

## TOP LIGHT KIT FOR POST STYLE BOAT GUIDES - LED

### FITS INSIDE 2" PVC PIPE

- Add a pair of these amber and red lamps on top of your existing post guide-ons and see your trailer's position clearly as you back up



**PART # CS27656A 36.70 G LED Top Light Kit For Post Guides, Packaged**

accessories  
towables  
body  
controls  
electrical  
driveline  
engine  
fuel & intake  
chemicals  
tie downs  
tools  
towing & loading

MARINE

## 1-9

|                           |     |
|---------------------------|-----|
| <b>1/2 Dr. Extensions</b> |     |
| Performance Tool .....    | 421 |
| <b>1/2 Dr. Sockets</b>    |     |
| Performance Tool .....    | 422 |
| <b>1/4 Inch Adapter</b>   |     |
| Performance Tool .....    | 419 |
| <b>12V Outlet</b>         |     |
| Buyers .....              | 442 |
| <b>2 Part Epoxy</b>       |     |
| JB Weld .....             | 367 |
| <b>2 Stroke Oil</b>       |     |
| Bel-Ray.....              | 342 |
| PJ1 .....                 | 348 |
| <b>3 Jaw Puller</b>       |     |
| Performance Tool .....    | 441 |
| <b>3 Way Outlet</b>       |     |
| Buyers .....              | 442 |
| <b>6 In 1 Lubricant</b>   |     |
| Bel-Ray.....              | 346 |
| <b>90 Degree Driver</b>   |     |
| Motion Pro.....           | 443 |

## A

|                                   |         |
|-----------------------------------|---------|
| <b>ACF-50</b>                     |         |
| Corrosion Block.....              | 384-385 |
| Corrosion Protectant .....        | 384-385 |
| Waterproof Grease.....            | 385     |
| <b>Adapter</b>                    |         |
| Performance Tool .....            | 419     |
| <b>Adhesive Gel</b>               |         |
| Threebond.....                    | 364     |
| <b>Air Filter</b>                 |         |
| K&N.....                          | 308-313 |
| <b>Air Filter Cleaner</b>         |         |
| K&N.....                          | 357     |
| Klotz .....                       | 339     |
| Maxima.....                       | 335     |
| PJ1 .....                         | 349     |
| Uni.....                          | 356     |
| <b>Air Filter Cleaner Kit</b>     |         |
| Maxima.....                       | 336     |
| <b>Air Filter Degreaser</b>       |         |
| K&N.....                          | 357     |
| <b>Air Filter Maintenance Kit</b> |         |
| K&N.....                          | 357     |
| Uni.....                          | 356     |
| <b>Air Filter Oil</b>             |         |
| K&N.....                          | 357     |
| Uni.....                          | 356     |

|                            |         |
|----------------------------|---------|
| <b>Air Pressure Gauge</b>  |         |
| Airhead.....               | 110     |
| <b>Air Pump</b>            |         |
| Airhead.....               | 107-110 |
| <b>Airhead</b>             |         |
| Air Pressure Gauge.....    | 110     |
| Air Pump .....             | 107-110 |
| Aquazooka .....            | 44-45   |
| Bindings .....             | 58-59   |
| Designer Tubes .....       | 84-85   |
| Dock Line .....            | 39      |
| Double Tubes .....         | 62-78   |
| Electric Air Pump.....     | 107-110 |
| Hand Pump .....            | 109     |
| Hot Dog Tube .....         | 77      |
| Inflatable Boat .....      | 87-88   |
| Inflatable Kayak.....      | 87-88   |
| Inflatable Mat.....        | 79      |
| Inflatable SUP .....       | 89-92   |
| Kayak Paddle .....         | 97      |
| Keyhole Life Jacket.....   | 16      |
| Kneeboard.....             | 57      |
| Kwik Connect .....         | 39      |
| Leash .....                | 42      |
| Life Jacket .....          | 12-16   |
| Life Vest.....             | 12-16   |
| Multi Rider Rope .....     | 101-102 |
| Noodle.....                | 86      |
| Paddle .....               | 96-98   |
| Personal Floats .....      | 80-86   |
| Pfd.....                   | 12-16   |
| Pong Float.....            | 81      |
| Rescue Bag.....            | 39      |
| River Tube .....           | 83      |
| Skim Wakeboard .....       | 57      |
| Squirt Gun.....            | 44-45   |
| Stand Up Paddle Board..... | 89-94   |
| Suction Cup Tie Down.....  | 43      |
| SUP Cargo Net .....        | 41      |
| SUP Carrier.....           | 40      |
| SUP Paddle.....            | 96-97   |
| SUP Stabilizers .....      | 40      |
| Telescoping Paddle .....   | 98      |
| The Orb .....              | 95      |
| Tow Behinds.....           | 62-78   |
| Tow Ropes .....            | 99-106  |
| Training Ski's .....       | 60      |
| Tubes.....                 | 62-78   |
| Wake Trainer .....         | 61      |
| Wakeboard .....            | 52-57   |
| Water Cannon .....         | 44-45   |
| Water Ski's .....          | 60      |
| Zero Stretch Tow Rope..... | 101     |

|                             |         |
|-----------------------------|---------|
| <b>Alarms</b>               |         |
| WSM .....                   | 206-207 |
| <b>Allen Key</b>            |         |
| Performance Tool .....      | 423     |
| <b>Allen Wrench</b>         |         |
| Performance Tool .....      | 423     |
| <b>Aluminum Cleaner</b>     |         |
| Bio-Kleen.....              | 327     |
| <b>Anchor</b>               |         |
| Atlantis .....              | 49      |
| Jet Logic.....              | 32      |
| <b>Ankra</b>                |         |
| Cam Lock Strap.....         | 388-389 |
| Rat Pak.....                | 389     |
| Ratchet Strap .....         | 388-389 |
| Soft Hook Extension.....    | 389     |
| Tie Down Strap.....         | 388-389 |
| <b>Angle Grinder</b>        |         |
| Performance Tool .....      | 430     |
| <b>Anti Fog Cleaner</b>     |         |
| Liquid Performance .....    | 360     |
| Sled Brite.....             | 325     |
| <b>Anti Fog Coating</b>     |         |
| Bike Bright.....            | 377     |
| <b>Anti Freeze</b>          |         |
| Bel-Ray.....                | 345     |
| Maxima.....                 | 333-334 |
| <b>Anti Seize Lubricant</b> |         |
| Permatex .....              | 380     |
| <b>Antifreeze</b>           |         |
| Liquid Performance .....    | 362     |
| <b>Aquazooka</b>            |         |
| Airhead.....                | 44-45   |
| <b>Armature Coil</b>        |         |
| WSM .....                   | 219-223 |
| <b>Assembly Lube</b>        |         |
| Bel-Ray.....                | 345     |
| Klotz .....                 | 339     |
| PJ1 .....                   | 352     |
| <b>Atlantis</b>             |         |
| Anchor.....                 | 49      |
| Drain Plug .....            | 48      |
| Floating Lanyard.....       | 50      |
| Flush Kits .....            | 285-288 |
| Hull Guard Fender.....      | 49      |
| Key Floats .....            | 48      |
| Lanyard .....               | 50      |
| Sand Anchor .....           | 49      |
| Stake Anchor.....           | 49      |
| Sunglasses Floats.....      | 48      |
| <b>Axle Strap</b>           |         |
| Erickson .....              | 395     |

## B

- Ball End Allen Set**
  - Performance Tool ..... 424
- Ball Pein Hammer**
  - Performance Tool ..... 424
- Batteries**
  - Battery Tender ..... 183-184
  - Power Sonic ..... 179-181
  - Yuasa ..... 174-178
- Battery Acid Tester**
  - ..... 205
- Battery Cables**
  - ..... 205
- Battery Charger**
  - Battery Tender ..... 194-197
  - Yuasa ..... 193
- Battery Charger Leads**
  - Battery Tender ..... 198
- Battery Chargers**
  - Genius ..... 199-200
- Battery Cleaner**
  - Permatex ..... 378
- Battery Cross Reference Chart**
  - ..... 190-191
- Battery Pack**
  - Genius ..... 203
- Battery Siphon**
  - ..... 415
- Battery Tender**
  - Batteries ..... 183-184
  - Battery Charger ..... 194-197
  - Battery Charger Leads ..... 198
  - Multi Bank Charger ..... 196
  - Terminal Cleaner ..... 197
  - USB Charger ..... 197
- Battery Terminal Cleaner**
  - Performance Tool ..... 438
- Battery Tester**
  - Yuasa ..... 193
- Bearing And Race Driver**
  - Performance Tool ..... 433
- Bel-Ray**
  - 2 Stroke Oil ..... 342
  - 6 In 1 Lubricant ..... 346
  - Anti Freeze ..... 345
  - Assembly Lube ..... 345
  - Biodegradable Lubricant ..... 341
  - Brake Cleaner ..... 344
  - Coolant ..... 345
  - Fabric Filter Oil ..... 346
  - Gear Oil ..... 343
  - Injection Oil ..... 341-342
  - Rust Preventative Coating ..... 341
  - Semi Synthetic Gear Oil ..... 343
  - Silicone Lubricant ..... 342
  - Waterproof Grease ..... 342
  - Waterproof Grease ..... 345
- Benol Injection Oil**
  - Klotz ..... 338
- Bike Bright**
  - Anti Fog Coating ..... 377
  - Chain Lube ..... 375
  - Chamois ..... 376
  - Display Rack ..... 377
  - Helmet Freshener ..... 375
  - Jumbo Polishing Towel ..... 376
  - Microfiber Drying Towel ..... 376
  - Moto Mask Windshield Coating .. 377
  - Moto Shine ..... 375
- Bike Brite**
  - Blue Buster ..... 374
  - Moto Spray Wash ..... 374
  - Windshield Cleaner ..... 375
  - Wipes ..... 375
- Bike Magik**
  - Degreaser ..... 324
  - Quick Shine ..... 324
  - Super Suds Wash ..... 324
- Bike Spirits**
  - Carb Cleaner ..... 386
  - Chain Lube ..... 386
  - Chain Lube With Graphite ..... 386
  - Cycle Wash ..... 386
  - Fuel System Cleaner ..... 386
  - Spray Cleaner ..... 386
- Bilge Cleaner**
  - Bio-Kleen ..... 328
- Bindings**
  - Airhead ..... 58-59
- Bio Wash**
  - Maxima ..... 336
- Biodegradable Lubricant**
  - Bel-Ray ..... 341
- Bio-Kleen**
  - Aluminum Cleaner ..... 327
  - Bilge Cleaner ..... 328
  - Black Streak Remover ..... 328
  - Boat Wax ..... 326
  - Fiberglass Cleaner ..... 327
  - Fiberglass Restore And Shine ... 329
  - Glass Cleaner ..... 329
  - H2O Repel ..... 326
  - Hull Cleaner ..... 328
  - Leather And Fabric Cleaner ..... 327
  - Metal Polish ..... 326
  - Oxidation Remover ..... 327
  - Polishing Ball ..... 326
  - Quick Shine ..... 328
  - Remove All ..... 328
  - Renew Polish ..... 326
  - Salt Cleaner ..... 329
  - Super Suds Wash ..... 329
  - Vinyl Conditioner ..... 327
  - Wheel Gel ..... 329
- Black Silicone**
  - JB Weld ..... 371
- Black Streak Remover**
  - Bio-Kleen ..... 328
- Blind Bearing Remover Tool**
  - Motion Pro ..... 439
- Blue Buster**
  - Bike Brite ..... 374
- Blue Silicone**
  - JB Weld ..... 371
  - Permatex ..... 380
- Boat Rollers**
  - Yates Rubber ..... 462-463
- Boat Wax**
  - Bio-Kleen ..... 326
- Bolt Assortment**
  - Performance Tool ..... 446
- Bolt Sizing Tool**
  - Performance Tool ..... 433
- Booster Ball**
  - Sports Stuff ..... 116
- Booster Pack**
  - Genius ..... 201
- Bottom End Kits**
  - Hot Rods ..... 272
- Bow Rollers**
  - Yates Rubber ..... 462-463
- Bow Stops**
  - Yates Rubber ..... 462-463
- Braided Fuel Line**
  - Motion Pro ..... 318
- Brake Cleaner**
  - Bel-Ray ..... 344
  - Liquid Performance ..... 360
  - Permatex ..... 378
  - PJ1 ..... 350
- Brake Winches**
  - Fulton ..... 459
- Break Away Knife**
  - Performance Tool ..... 428
- Break In Oil**
  - Maxima ..... 334
- Brush**
  - Performance Tool ..... 430
- Bumpers**
  - Hull Huger ..... 35-37
- Bungee Cord**
  - Erickson ..... 400-401
  - Highlands ..... 411
  - Highlands ..... 411-412
- Bunk Brackets**
  - Fulton ..... 464
- Bunk Carpets**
  - Caliper ..... 460
- Bunk Guide On**
  - Shipshape ..... 466
- Bunk Slides**
  - Caliper ..... 460
- Buoys**
  - Kwik Tek ..... 38
- Buyers**
  - 12V Outlet ..... 442
  - 3 Way Outlet ..... 442
  - Hand Winch ..... 459
  - Ratchet Strap ..... 405
  - Spring Latch ..... 462



- C Clamp**  
Performance Tool ..... 426
- Cable Lubricant**  
PJ1 ..... 352
- Cable Ties**  
Performance Tool ..... 432
- Caliper**  
Bunk Carpets ..... 460  
Bunk Slides ..... 460
- Cam Chain**  
ProX ..... 249-257
- Cam Lock Strap**  
Ancra ..... 388-389  
Erickson ..... 390-395  
Highlands ..... 407  
SPI ..... 405
- Carb Adapter**  
K&N ..... 305-307
- Carb Adjusting Tool**  
Motion Pro ..... 443
- Carb And Choke Cleaner**  
Gold Eagle ..... 355
- Carb Approved Fuel Line**  
..... 317
- Carb Cleaner**  
Bike Spirits ..... 386
- Carb Leak Detector**  
..... 443
- Carb Rebuild Kit**  
Keihin ..... 296  
Winderosa ..... 304
- Carb Synchronizer**  
Edelbrock ..... 443
- Carb Tool Kit**  
Mikuni ..... 443
- Carburetor Cleaner**  
Ipone ..... 347  
PJ1 ..... 350
- Cargo Bar**  
Erickson ..... 403
- Cargo Net**  
Erickson ..... 401
- CDI Box**  
WSM ..... 230
- Chain Lube**  
Bike Bright ..... 375  
Bike Spirits ..... 386  
Permatex ..... 378
- Chain Lube With Graphite**  
Bike Spirits ..... 386
- Chamois**  
Bike Bright ..... 376
- Channel Lock Pliers**  
Performance Tool ..... 425
- Charge Coil**  
WSM ..... 219-223
- Chisel Set**  
Performance Tool ..... 429
- Choke Block Off**  
Keihin ..... 296
- Chrome Oil Filter**  
K&N ..... 308-313
- Chrome Protector**  
Erickson ..... 396
- Cipa**  
Die Cast Mirror ..... 140-142  
Dock Cleat ..... 144  
Hand Mirror ..... 143  
Mirror ..... 140-145  
Wing Mirror ..... 143
- Circlips**  
ProX ..... 249-257  
Wiseco ..... 240-246
- Circuit Tester**  
Performance Tool ..... 438
- Classic Accessories**  
Covers ..... 148-156  
Pwc Covers ..... 152-156  
Seat Cover ..... 153  
Towable Covers ..... 148-152
- Claw Retriever**  
Performance Tool ..... 437
- Clean Up**  
Maxima ..... 335
- Clear Pvc Fuel Line**  
..... 318
- Clear Silicone**  
JB Weld ..... 371
- Clymer**  
Repair Manual ..... 17-19
- Coil**  
WSM ..... 219-223
- Combination Wrench**  
Performance Tool ..... 428
- Combo Y Drive Wrench**  
Motion Pro ..... 416
- Cometic**  
Gasket Kit ..... 273-274  
Top End Gasket Kit ..... 273-274
- Compression Tester**  
Motion Pro ..... 445  
Performance Tool ..... 444
- Connecting Rod**  
Hot Rods ..... 271  
ProX ..... 249-257  
WSM ..... 270
- Contact Cleaner**  
Klotz ..... 339  
Maxima ..... 336  
PJ1 ..... 350
- Container Hose**  
VP Racing ..... 449
- Containers**  
VP Racing ..... 448-449
- Control Cables**  
WSM ..... 161-172
- Coolant**  
Bel-Ray ..... 345  
Liquid Performance ..... 362  
Maxima ..... 333-334  
Star Tron ..... 356
- Cooler Caddy**  
Sports Stuff ..... 135
- Corrosion Block**  
ACF-50 ..... 384-385
- Corrosion Control Grease**  
Lubrimatic ..... 381
- Corrosion Protectant**  
ACF-50 ..... 384-385  
S100 ..... 321
- Counter Balance Seal**  
Winderosa ..... 277
- Counter Balancer**  
Hot Rods ..... 272
- Coupler**  
WSM ..... 236-237
- Coupler Shaft**  
WSM ..... 237
- Covers**  
Classic Accessories ..... 148-156
- Crank Bearings**  
ProX ..... 249-257  
Wiseco ..... 240-246
- Crank Pin**  
ProX ..... 249-257
- Crank Seals**  
Hot Rods ..... 272  
Wiseco ..... 240-246
- Crank Web**  
ProX ..... 249-257
- Crankshaft**  
Hot Rods ..... 271
- Creeper**  
Performance Tool ..... 415
- Crimping Tool**  
Performance Tool ..... 426
- Cup Oil Filter Wrench**  
Emgo ..... 425
- Cupped Wire Brush**  
Performance Tool ..... 436
- Custom Lettering Kit**  
Hardline ..... 22-23
- Cycle Wash**  
Bike Spirits ..... 386  
Liquid Performance ..... 361
- Cylinder Hone**  
Performance Tool ..... 438

## D

|                                |         |
|--------------------------------|---------|
| <b>Dampeners</b>               |         |
| WSM .....                      | 236     |
| <b>Deep Sockets</b>            |         |
| Performance Tool .....         | 419     |
| <b>Degreaser</b>               |         |
| Bike Magik .....               | 324     |
| <b>Degree Wheel</b>            |         |
| Motion Pro .....               | 439     |
| <b>Designer Safety Glasses</b> |         |
| Elvex .....                    | 435     |
| <b>Designer Tubes</b>          |         |
| Airhead .....                  | 84-85   |
| <b>Detail + Wax</b>            |         |
| S100 .....                     | 322     |
| <b>Detailing Swabs</b>         |         |
| S100 .....                     | 323     |
| <b>Die Cast Mirror</b>         |         |
| Cipa .....                     | 140-142 |
| <b>Diesel Fuel Treatment</b>   |         |
| K100 .....                     | 353     |
| <b>Digital Caliper</b>         |         |
| Performance Tool .....         | 432     |
| <b>Display Rack</b>            |         |
| Bike Bright .....              | 377     |
| Maxima .....                   | 337     |
| <b>Distress Strobe</b>         |         |
| Marine FX .....                | 47      |
| <b>Dock Bumper</b>             |         |
| Hull Hugr .....                | 37      |
| <b>Dock Cleat</b>              |         |
| Cipa .....                     | 144     |
| <b>Dock Line</b>               |         |
| Airhead .....                  | 39      |
| <b>Double Tubes</b>            |         |
| Airhead .....                  | 62-78   |
| <b>Drain Pan</b>               |         |
| Flo Tools .....                | 414     |
| Performance Tool .....         | 415     |
| <b>Drain Plug</b>              |         |
| Atlantis .....                 | 48      |
| <b>Drill Bit</b>               |         |
| Performance Tool .....         | 429     |
| <b>Drive Shaft</b>             |         |
| WSM .....                      | 232-235 |
| <b>Dry Pak</b>                 |         |
| Dry Pak .....                  | 25-30   |
| <b>Dry Pak</b>                 |         |
| Dry Pak .....                  | 25-30   |
| Waterproof Camera Case .....   | 28      |
| Waterproof Cell Phone Case ..  | 25-30   |
| Waterproof Gear Bag .....      | 29-30   |
| <b>Drying Towel</b>            |         |
| S100 .....                     | 321     |
| <b>Duct Tape</b>               |         |
| Performance Tool .....         | 440     |

## E

|                                 |         |
|---------------------------------|---------|
| <b>Ear Muffs</b>                |         |
| Elvex .....                     | 434     |
| <b>Edelbrock</b>                |         |
| Carb Synchronizer .....         | 443     |
| <b>Electric Air Pump</b>        |         |
| Airhead .....                   | 107-110 |
| Sports Stuff .....              | 138     |
| <b>Electro Pods</b>             |         |
| Marine FX .....                 | 46-47   |
| <b>Elvex</b>                    |         |
| Designer Safety Glasses .....   | 435     |
| Ear Muffs .....                 | 434     |
| Go-Specs .....                  | 435     |
| Hard Hat .....                  | 434     |
| Hearing Protection .....        | 434     |
| Safety Glasses .....            | 434     |
| <b>Emergency Charger</b>        |         |
| Performance Tool .....          | 442     |
| <b>Emgo</b>                     |         |
| Cup Oil Filter Wrench .....     | 425     |
| Spark Plug Wrench .....         | 441     |
| <b>Emgo</b>                     |         |
| In Line Fuse .....              | 205     |
| Jumper Cables .....             | 205,440 |
| Mirror .....                    | 21      |
| <b>Engine Brightener</b>        |         |
| S100 .....                      | 322     |
| <b>Engine Case Paint</b>        |         |
| PJ1 .....                       | 351     |
| <b>Engine Degreaser</b>         |         |
| Permatex .....                  | 378     |
| <b>Engine Mounts</b>            |         |
| WSM .....                       | 278-279 |
| <b>Engine Oil</b>               |         |
| Klotz .....                     | 338-340 |
| Maxima .....                    | 330-332 |
| PJ1 .....                       | 348     |
| <b>Erickson</b>                 |         |
| Axle Strap .....                | 395     |
| Bungee Cord .....               | 400-401 |
| Cam Lock Strap .....            | 390-395 |
| Cargo Bar .....                 | 403     |
| Cargo Net .....                 | 401     |
| Chrome Protector .....          | 396     |
| Flat Bungee .....               | 400,456 |
| Logistic Strap .....            | 395     |
| Mesh Tarp .....                 | 455     |
| Mini Winch .....                | 398     |
| Poly Tarp .....                 | 455     |
| Ratchet Strap .....             | 390-395 |
| Recovery Strap .....            | 397     |
| Retractable Ratchet Strap ..... | 390     |
| Rope Ratchet .....              | 403     |
| Rubber Handle Tie Downs ..      | 392-393 |
| Rubber Tarp Strap .....         | 401,456 |
| Strap Hanger .....              | 397     |
| Tarps .....                     | 455     |
| Tie Down Strap .....            | 390-395 |
| Tie Off .....                   | 404     |
| Tire Strap .....                | 404     |
| Tow Ropes .....                 | 397     |
| Transom Tie Down .....          | 401     |
| Transom/Bow Eyelet .....        | 402     |
| Transom/Bow U Bolt .....        | 402     |
| Winch Strap .....               | 399,461 |

|                          |         |
|--------------------------|---------|
| <b>Ester Engine Oil</b>  |         |
| Maxima .....             | 331-332 |
| <b>Ethanol Equalizer</b> |         |
| Liquid Performance ..... | 359     |
| <b>Ethanol Treatment</b> |         |
| Gold Eagle .....         | 354     |
| K100 .....               | 353     |
| <b>Exciter Coil</b>      |         |
| WSM .....                | 219-223 |
| <b>Exhaust Paint</b>     |         |
| PJ1 .....                | 351     |
| <b>Extensions</b>        |         |
| Performance Tool .....   | 419     |
| <b>Extractor Set</b>     |         |
| Performance Tool .....   | 430     |
| <b>Ez-Throttle</b>       |         |
| Hardline .....           | 158     |

## F

|                                     |         |
|-------------------------------------|---------|
| <b>Fabric Filter Oil</b>            |         |
| Bel-Ray .....                       | 346     |
| Klotz .....                         | 339     |
| <b>Fast Orange</b>                  |         |
| Permatex .....                      | 379     |
| <b>Fat Bungey</b>                   |         |
| Highlands .....                     | 411     |
| <b>Feeler Gauge</b>                 |         |
| Performance Tool .....              | 433     |
| <b>Fiberglass Cleaner</b>           |         |
| Bio-Kleen .....                     | 327     |
| <b>Fiberglass Restore And Shine</b> |         |
| Bio-Kleen .....                     | 329     |
| <b>Fittings</b>                     |         |
| .....                               | 316     |
| <b>Flame Arrestor</b>               |         |
| K&N .....                           | 305-307 |
| <b>Flashlight</b>                   |         |
| Performance Tool .....              | 431     |
| <b>Flat Bungey</b>                  |         |
| Erickson .....                      | 400,456 |
| <b>Flex Funnel</b>                  |         |
| Flo Tools .....                     | 452     |
| <b>Flex Socket</b>                  |         |
| Performance Tool .....              | 419     |
| <b>Flo Tools</b>                    |         |
| Drain Pan .....                     | 414     |
| Flex Funnel .....                   | 452     |
| Funnel .....                        | 451-453 |
| Locking Oil Funnel .....            | 451     |
| Multi Funnel .....                  | 451     |
| Shaker Siphon .....                 | 452     |
| Transmission Funnel .....           | 451     |

## G

## H

- Floating Lanyard**  
Atlantis ..... 50
- Floating Trampoline**  
Sports Stuff ..... 136
- Flush Kits**  
Atlantis ..... 285-288
- Flywheel Puller**  
Motion Pro ..... 441
- Fog Blocker**  
PJ1 ..... 352
- Fogging Oil**  
Gold Eagle ..... 355  
Lubrimatic ..... 382
- Folding Knife**  
Performance Tool ..... 428
- Fuel De-Icer**  
Maxima ..... 334
- Fuel Dryer**  
Sta-Dri ..... 453
- Fuel Filter**  
Visu Filter ..... 314-315
- Fuel Fittings**  
..... 316
- Fuel Line**  
..... 317
- Fuel Pump Rebuild**  
Winderosa ..... 304
- Fuel Shut Off**  
..... 316
- Fuel Stabilizer**  
Gold Eagle ..... 354  
K100 ..... 353  
Maxima ..... 334
- Fuel System Cleaner**  
Bike Spirits ..... 386  
Liquid Performance ..... 359
- Fuel System Lube**  
Klotz ..... 338
- Fuel Treatment**  
K100 ..... 353  
Star Tron ..... 356
- Full Gasket Set**  
Winderosa ..... 275-276
- Fulton**  
Brake Winches ..... 459  
Bunk Brackets ..... 464  
Hand Winch ..... 458-459  
Safety Chain ..... 461  
Snap Hook ..... 461  
Winch Cable ..... 461
- Funnel**  
Flo Tools ..... 451-453  
Mr. Funnel ..... 450  
Performance Tool ..... 453
- Fuse Assortment**  
Performance Tool ..... 446
- Gas Additive**  
Star Tron ..... 356
- Gas Line Anti Freeze**  
Gold Eagle ..... 355
- Gasket Kit**  
Cometic ..... 273-274  
Winderosa ..... 275-276  
Wiseco ..... 240-246
- Gasket Maker**  
Threebond ..... 363
- Gasket Scraper**  
Performance Tool ..... 429
- Gear Lube**  
Lubrimatic ..... 382
- Gear Oil**  
Bel-Ray ..... 343  
Maxima ..... 333
- Genius**  
Battery Chargers ..... 199-200  
Battery Pack ..... 203  
Booster Pack ..... 201  
On Board Charger ..... 201-202  
Solar Charger ..... 203
- Glass Cleaner**  
Bio-Kleen ..... 329
- Glue**  
Threebond ..... 364
- Gold Eagle**  
Carb And Choke Cleaner ..... 355  
Ethanol Treatment ..... 354  
Fogging Oil ..... 355  
Fuel Stabilizer ..... 354  
Gas Line Anti Freeze ..... 355  
Octane Booster ..... 355  
Water Remover ..... 355
- Go-Specs**  
Elvex ..... 435
- Grease Gun**  
Lubrimatic ..... 381,414  
Performance Tool ..... 383,414
- Grease Spray**  
Ipone ..... 347
- Grip Lock**  
Threebond ..... 365
- Grooved Mats**  
Hydro-Turf ..... 146-147
- H2O Repel**  
Bio-Kleen ..... 326
- Hammer**  
Performance Tool ..... 424
- Hand Cleaner**  
Permatex ..... 379
- Hand Mirror**  
Cipa ..... 143  
SPI ..... 21
- Hand Pump**  
Airhead ..... 109  
Sports Stuff ..... 138
- Hand Soap**  
Permatex ..... 379
- Hand Winch**  
Buyers ..... 459  
Fulton ..... 458-459
- Handlebar Grips**  
..... 159-160  
Progrip ..... 159  
Spider Grips ..... 160
- Hard Hat**  
Elvex ..... 434
- Hardline**  
Custom Lettering Kit ..... 22-23  
Ez-Throttle ..... 158  
Hour/Tach Meter ..... 454  
Letter Kit ..... 22-23  
Mini Tach ..... 454  
Number Kit ..... 22-23  
Stop Watch ..... 454
- Hardware Assortments**  
Performance Tool ..... 446
- Head Lamp**  
Performance Tool ..... 431
- Hearing Protection**  
Elvex ..... 434
- Helix**  
Hose Protector ..... 318
- Helmet Freshener**  
Bike Bright ..... 375
- Hex Bit Sockets**  
Performance Tool ..... 422
- Hi Temp Silicone**  
JB Weld ..... 372
- Hi Temp Thread Locker**  
Threebond ..... 366
- Hi-Flo**  
Oil Filter ..... 283-284
- High Heat Epoxy**  
JB Weld ..... 370
- High Speed Jet**  
Mikuni ..... 298
- Highlands**  
Bungee Cord ..... 411  
Bungee Cord ..... 411-412  
Cam Lock Strap ..... 407  
Fat Bungee ..... 411  
Ratchet Strap ..... 407-410  
Retractable Ratchet Strap ..... 408  
Stainless Steel Ratchet Strap ..... 409



|                          |         |
|--------------------------|---------|
| <b>Hose Protector</b>    |         |
| Helix .....              | 318     |
| <b>Hot Dog Tube</b>      |         |
| Airhead .....            | 77      |
| <b>Hot Rods</b>          |         |
| Bottom End Kits .....    | 272     |
| Connecting Rod .....     | 271     |
| Counter Balancer .....   | 272     |
| Crank Seals .....        | 272     |
| Crankshaft .....         | 271     |
| Main Bearings .....      | 272     |
| Rod Kit .....            | 271     |
| <b>Hour Meter</b>        |         |
| Wiseco .....             | 454     |
| <b>Hour/Tach Meter</b>   |         |
| Hardline .....           | 454     |
| <b>Hull Bumper</b>       |         |
| Hull Huger .....         | 35-37   |
| <b>Hull Cleaner</b>      |         |
| Bio-Kleen .....          | 328     |
| <b>Hull Guard Fender</b> |         |
| Atlantis .....           | 49      |
| <b>Hull Huger</b>        |         |
| Bumpers .....            | 35-37   |
| Dock Bumper .....        | 37      |
| Hull Bumper .....        | 35-37   |
| Hull Protector .....     | 35-37   |
| <b>Hull Protector</b>    |         |
| Hull Huger .....         | 35-37   |
| <b>Hydro-Turf</b>        |         |
| Grooved Mats .....       | 146-147 |
| Mats .....               | 146-147 |
| Oil Extractor .....      | 415     |

|                               |         |
|-------------------------------|---------|
| <b>Ignition Coil</b>          |         |
| WSM .....                     | 219-223 |
| <b>Ignition Tester</b>        |         |
| .....                         | 439     |
| <b>Impact Driver</b>          |         |
| Performance Tool .....        | 424     |
| <b>Impeller Protector</b>     |         |
| Jet Logic .....               | 34      |
| <b>In Line Fuse</b>           |         |
| Emgo .....                    | 205     |
| <b>Inflatable Boat</b>        |         |
| Airhead .....                 | 87-88   |
| <b>Inflatable Kayak</b>       |         |
| Airhead .....                 | 87-88   |
| <b>Inflatable Mat</b>         |         |
| Airhead .....                 | 79      |
| <b>Inflatable SUP</b>         |         |
| Airhead .....                 | 89-92   |
| <b>Injection Oil</b>          |         |
| Bel-Ray .....                 | 341-342 |
| Maxima .....                  | 331-332 |
| PJ1 .....                     | 348     |
| <b>Injector Cleaner</b>       |         |
| PJ1 .....                     | 349     |
| <b>In-Line Fuel Filter</b>    |         |
| Visu Filter .....             | 314-315 |
| <b>Intake Gaskets</b>         |         |
| WSM .....                     | 290-293 |
| <b>Ipone</b>                  |         |
| Carburetor Cleaner .....      | 347     |
| Grease Spray .....            | 347     |
| Moto-Wash .....               | 347     |
| Multi Purpose Lubricant ..... | 347     |

|                                   |         |
|-----------------------------------|---------|
| <b>JB Weld</b>                    |         |
| 2 Part Epoxy .....                | 367     |
| Black Silicone .....              | 371     |
| Blue Silicone .....               | 371     |
| Clear Silicone .....              | 371     |
| Hi Temp Silicone .....            | 372     |
| High Heat Epoxy .....             | 370     |
| Kwik Wood Epoxy .....             | 369     |
| Low Viscosity Thread Locker ..... | 373     |
| Marine Weld Epoxy .....           | 368     |
| Minute Weld Epoxy .....           | 368     |
| Perma-Lock Thread Locker .....    | 373     |
| Plastic Weld Epoxy .....          | 368     |
| Quick Epoxy .....                 | 367     |
| Radiator Stop Leak .....          | 370     |
| Ultimate Black Silicone .....     | 372     |
| Water Weld Epoxy .....            | 369     |
| White Silicone .....              | 371     |
| Wood Weld Epoxy .....             | 368     |
| <b>Jet Carrier</b>                |         |
| SPI .....                         | 444     |
| <b>Jet Logic</b>                  |         |
| Anchor .....                      | 32      |
| Impeller Protector .....          | 34      |
| Lanyard .....                     | 33      |
| Pwc Fenders .....                 | 34      |
| Sand Anchor .....                 | 32      |
| Tube Anchor .....                 | 32      |
| Whistle .....                     | 33      |
| <b>Jet Pump Lubricant</b>         |         |
| Klotz .....                       | 340     |
| <b>Jet Wrench</b>                 |         |
| Motion Pro .....                  | 444     |
| <b>Juice</b>                      |         |
| Jumper Cables .....               | 440     |
| <b>Jumbo Polishing Towel</b>      |         |
| Bike Bright .....                 | 376     |
| <b>Jumper Cables</b>              |         |
| Emgo .....                        | 205,440 |
| Juice .....                       | 440     |
| Yuasa .....                       | 193     |



## K

## L

## M

**K&N**

|                                 |         |
|---------------------------------|---------|
| Air Filter.....                 | 308-313 |
| Air Filter Cleaner.....         | 357     |
| Air Filter Degreaser.....       | 357     |
| Air Filter Maintenance Kit..... | 357     |
| Air Filter Oil.....             | 357     |
| Carb Adapter.....               | 305-307 |
| Chrome Oil Filter.....          | 308-313 |
| Flame Arrestor.....             | 305-307 |
| Oil Filter.....                 | 280-282 |
| Oil Filter.....                 | 308-313 |
| Sealing Grease.....             | 357     |

**K100**

|                            |     |
|----------------------------|-----|
| Diesel Fuel Treatment..... | 353 |
| Ethanol Treatment.....     | 353 |
| Fuel Stabilizer.....       | 353 |
| Fuel Treatment.....        | 353 |

**Katahdin Gear**

|                  |    |
|------------------|----|
| Kid Carrier..... | 20 |
|------------------|----|

**Kayak Paddle**

|              |    |
|--------------|----|
| Airhead..... | 97 |
|--------------|----|

**Keihin**

|                       |     |
|-----------------------|-----|
| Carb Rebuild Kit..... | 296 |
| Choke Block Off.....  | 296 |
| Main Jets.....        | 297 |
| Needle Valve.....     | 295 |
| Slow Jets.....        | 297 |

**Key Floats**

|               |    |
|---------------|----|
| Atlantis..... | 48 |
|---------------|----|

**Keyhole Life Jacket**

|              |    |
|--------------|----|
| Airhead..... | 16 |
|--------------|----|

**Kid Carrier**

|                    |    |
|--------------------|----|
| Katahdin Gear..... | 20 |
|--------------------|----|

**Kill Switch Keys**

|               |    |
|---------------|----|
| Kwik Tek..... | 38 |
|---------------|----|

**Klotz**

|                          |         |
|--------------------------|---------|
| Air Filter Cleaner.....  | 339     |
| Assembly Lube.....       | 339     |
| Benol Injection Oil..... | 338     |
| Contact Cleaner.....     | 339     |
| Engine Oil.....          | 338-340 |
| Fabric Filter Oil.....   | 339     |
| Fuel System Lube.....    | 338     |
| Jet Pump Lubricant.....  | 340     |
| Nitro Additive.....      | 339     |
| Octane Booster.....      | 338     |
| Outboard Engine Oil..... | 340     |

**Kneeboard**

|              |    |
|--------------|----|
| Airhead..... | 57 |
|--------------|----|

**Kwik Connect**

|              |    |
|--------------|----|
| Airhead..... | 39 |
|--------------|----|

**Kwik Tek**

|                       |    |
|-----------------------|----|
| Buoys.....            | 38 |
| Kill Switch Keys..... | 38 |
| Rope Floats.....      | 38 |

**Kwik Wood Epoxy**

|              |     |
|--------------|-----|
| JB Weld..... | 369 |
|--------------|-----|

**Lanyard**

|                |    |
|----------------|----|
| Atlantis.....  | 50 |
| Jet Logic..... | 33 |

**Laser Pointer**

|                       |     |
|-----------------------|-----|
| Performance Tool..... | 431 |
|-----------------------|-----|

**Leash**

|              |    |
|--------------|----|
| Airhead..... | 42 |
|--------------|----|

**Leather And Fabric Cleaner**

|                |     |
|----------------|-----|
| Bio-Kleen..... | 327 |
|----------------|-----|

**Leather Cleaner**

|                 |     |
|-----------------|-----|
| Sled Brite..... | 325 |
|-----------------|-----|

**Leather Renew And Protect**

|          |     |
|----------|-----|
| PJ1..... | 350 |
|----------|-----|

**Letter Kit**

|               |       |
|---------------|-------|
| Hardline..... | 22-23 |
|---------------|-------|

**Life Jacket**

|              |       |
|--------------|-------|
| Airhead..... | 12-16 |
|--------------|-------|

**Life Vest**

|              |       |
|--------------|-------|
| Airhead..... | 12-16 |
|--------------|-------|

**Light Strips**

|                |    |
|----------------|----|
| Marine FX..... | 46 |
|----------------|----|

**Lighting Coil**

|          |         |
|----------|---------|
| WSM..... | 219-223 |
|----------|---------|

**Liquid Performance**

|                               |     |
|-------------------------------|-----|
| Anti Fog Cleaner.....         | 360 |
| Antifreeze.....               | 362 |
| Brake Cleaner.....            | 360 |
| Coolant.....                  | 362 |
| Cycle Wash.....               | 361 |
| Ethanol Equalizer.....        | 359 |
| Fuel System Cleaner.....      | 359 |
| Metal Polish.....             | 359 |
| Microfiber Cloth.....         | 361 |
| Non-Glycol Coolant.....       | 362 |
| Paint Polish.....             | 358 |
| Poly Wax.....                 | 359 |
| Quick Detailing Kit.....      | 358 |
| Spray Cleaner And Polish..... | 358 |
| Topkote Finishing Spray.....  | 360 |

**Lithium Grease**

|                 |     |
|-----------------|-----|
| Lubrimatic..... | 381 |
|-----------------|-----|

**Locking Oil Funnel**

|                |     |
|----------------|-----|
| Flo Tools..... | 451 |
|----------------|-----|

**Logistic Strap**

|               |     |
|---------------|-----|
| Erickson..... | 395 |
|---------------|-----|

**Low Permeation Fuel Line**

|                 |     |
|-----------------|-----|
| Motion Pro..... | 318 |
|-----------------|-----|

**Low Viscosity Thread Locker**

|              |     |
|--------------|-----|
| JB Weld..... | 373 |
|--------------|-----|

**Lubrimatic**

|                               |         |
|-------------------------------|---------|
| Corrosion Control Grease..... | 381     |
| Fogging Oil.....              | 382     |
| Gear Lube.....                | 382     |
| Grease Gun.....               | 381,414 |
| Lithium Grease.....           | 381     |
| Midget Grease Gun.....        | 381     |
| Quart Pump.....               | 382     |
| White Lithium Grease.....     | 381     |

**Magnetic Retriever**

|                       |     |
|-----------------------|-----|
| Performance Tool..... | 437 |
|-----------------------|-----|

**Magnetic Tray**

|                       |     |
|-----------------------|-----|
| Performance Tool..... | 438 |
|-----------------------|-----|

**Main Bearings**

|               |         |
|---------------|---------|
| Hot Rods..... | 272     |
| ProX.....     | 249-257 |
| Wiseco.....   | 240-246 |

**Main Jets**

|             |     |
|-------------|-----|
| Keihin..... | 297 |
|-------------|-----|

**Maintenance Free Battery**

|                  |         |
|------------------|---------|
| Power Sonic..... | 179-180 |
| Yuasa.....       | 174-175 |

**Marine FX**

|                      |       |
|----------------------|-------|
| Distress Strobe..... | 47    |
| Electro Pods.....    | 46-47 |
| Light Strips.....    | 46    |
| Marker Lights.....   | 47    |

**Marine Weld Epoxy**

|              |     |
|--------------|-----|
| JB Weld..... | 368 |
|--------------|-----|

**Marker Lights**

|                |    |
|----------------|----|
| Marine FX..... | 47 |
|----------------|----|

**Mats**

|                 |         |
|-----------------|---------|
| Hydro-Turf..... | 146-147 |
|-----------------|---------|

**Maxima**

|                             |         |
|-----------------------------|---------|
| Air Filter Cleaner.....     | 335     |
| Air Filter Cleaner Kit..... | 336     |
| Anti Freeze.....            | 333-334 |
| Bio Wash.....               | 336     |
| Break In Oil.....           | 334     |
| Clean Up.....               | 335     |
| Contact Cleaner.....        | 336     |
| Coolant.....                | 333-334 |
| Display Rack.....           | 337     |
| Engine Oil.....             | 330-332 |
| Ester Engine Oil.....       | 331-332 |
| Fuel De-Icer.....           | 334     |
| Fuel Stabilizer.....        | 334     |
| Gear Oil.....               | 333     |
| Injection Oil.....          | 331-332 |
| Mix Bottle.....             | 336     |
| Octane Booster.....         | 335     |
| Pail Pump.....              | 337     |
| Penetrant Lube.....         | 336     |
| Pwc Engine Oil.....         | 332     |
| Silicone Detailer.....      | 336     |
| Speed Wax.....              | 335     |
| Waterproof Grease.....      | 337     |

**Measuring Container**

|       |     |
|-------|-----|
| ..... | 453 |
|-------|-----|

**Mechanic Gloves**

|                       |     |
|-----------------------|-----|
| Performance Tool..... | 438 |
|-----------------------|-----|

**Mesh Tarp**

|               |     |
|---------------|-----|
| Erickson..... | 455 |
|---------------|-----|

**Metal Polish**

|                         |     |
|-------------------------|-----|
| Bio-Kleen.....          | 326 |
| Liquid Performance..... | 359 |
| Sled Brite.....         | 325 |

**Microfiber Cloth**

|                         |     |
|-------------------------|-----|
| Liquid Performance..... | 361 |
|-------------------------|-----|

**Microfiber Drying Towel**

|                  |     |
|------------------|-----|
| Bike Bright..... | 376 |
|------------------|-----|

**Midget Grease Gun**

|                 |     |
|-----------------|-----|
| Lubrimatic..... | 381 |
|-----------------|-----|



|                                      |                                     |                                    |
|--------------------------------------|-------------------------------------|------------------------------------|
| <b>Mikuni</b>                        | Oil Filter Magnet..... 277          | <b>Needle Bearing</b>              |
| Carb Tool Kit..... 443               | Pincers ..... 445                   | Wiseco ..... 240-246               |
| High Speed Jet..... 298              | Pivot Head Wrench ..... 417         | <b>Needle Valve</b>                |
| Needle Valve ..... 299               | Quick Connect Coupling ..... 316    | Keihin ..... 295                   |
| Needle Valve Spring..... 299         | Snap Ring Pliers ..... 437          | Mikuni..... 299                    |
| Pop-Off Valve..... 299               | Step Less Clamps ..... 445          | <b>Needle Valve Spring</b>         |
| Slow Speed Jet ..... 298             | Syncpro Carb Tool..... 444          | Mikuni..... 299                    |
| Super Bn Parts..... 301              | T Handle Rack ..... 436             | <b>Nitro Additive</b>              |
| Throttle Shaft Rebuild ..... 299     | T Handle Spinner Wrench ..... 416   | Klotz ..... 339                    |
| <b>Mini Fuse Assortment</b>          | T Handle Wrench ..... 416,436       | <b>Non-Chlorinated Brake Clean</b> |
| Performance Tool ..... 433           | Titanium Wrenches ..... 417         | Permatex ..... 380                 |
| <b>Mini Sledge</b>                   | <b>Moto Mask Windshield Coating</b> | <b>Non-Glycol Coolant</b>          |
| Performance Tool ..... 424           | Bike Bright..... 377                | Liquid Performance ..... 362       |
| <b>Mini Tach</b>                     | <b>Moto Shine</b>                   | <b>Noodle</b>                      |
| Hardline..... 454                    | Bike Bright..... 375                | Airhead..... 86                    |
| <b>Mini Winch</b>                    | <b>Moto Spray Wash</b>              | <b>Nozzle Cable</b>                |
| Erickson ..... 398                   | Bike Brite..... 374                 | WSM ..... 172                      |
| <b>Minute Weld Epoxy</b>             | <b>Motor Mounts</b>                 | <b>Number Kit</b>                  |
| JB Weld ..... 368                    | WSM ..... 278-279                   | Hardline..... 22-23                |
| <b>Mirror</b>                        | <b>Moto-Wash</b>                    | <b>Nut Assortment</b>              |
| Cipa..... 140-145                    | Ipone ..... 347                     | Performance Tool ..... 446         |
| Emgo ..... 21                        | <b>Mr. Funnel</b>                   | <b>Nut Splitter</b>                |
| <b>Mix Bottle</b>                    | Funnel ..... 450                    | Performance Tool ..... 441         |
| Maxima..... 336                      | Water Removing Funnel..... 450      |                                    |
| <b>Motion Pro</b>                    | <b>Multi Bank Charger</b>           |                                    |
| 90 Degree Driver ..... 443           | Battery Tender..... 196             |                                    |
| Blind Bearing Remover Tool ..... 439 | <b>Multi Funnel</b>                 |                                    |
| Braided Fuel Line ..... 318          | Flo Tools ..... 451                 |                                    |
| Carb Adjusting Tool ..... 443        | <b>Multi Meter</b>                  |                                    |
| Combo Y Drive Wrench ..... 416       | Performance Tool ..... 438          |                                    |
| Compression Tester ..... 445         | <b>Multi Purpose Lubricant</b>      |                                    |
| Degree Wheel ..... 439               | Ipone ..... 347                     |                                    |
| Flywheel Puller..... 441             | <b>Multi Rider Rope</b>             |                                    |
| Jet Wrench ..... 444                 | Airhead..... 101-102                |                                    |
| Low Permeation Fuel Line..... 318    | <b>Multi Tool</b>                   |                                    |
|                                      | Performance Tool ..... 426          |                                    |

## O

## P

|                               |         |  |  |
|-------------------------------|---------|--|--|
| <b>Octane Booster</b>         |         |  |  |
| Gold Eagle .....              | 355     |  |  |
| Klotz .....                   | 338     |  |  |
| Maxima.....                   | 335     |  |  |
| PJ1 .....                     | 349     |  |  |
| <b>Oil Extractor</b>          |         |  |  |
| Hydro-Turf .....              | 415     |  |  |
| <b>Oil Filter</b>             |         |  |  |
| Hi-Flo.....                   | 283-284 |  |  |
| K&N.....                      | 280-282 |  |  |
| K&N.....                      | 308-313 |  |  |
| <b>Oil Filter Magnet</b>      |         |  |  |
| Motion Pro.....               | 277     |  |  |
| <b>Oil Filter Pliers</b>      |         |  |  |
| Performance Tool .....        | 425     |  |  |
| <b>Oil Filter Wrench</b>      |         |  |  |
| Performance Tool .....        | 425     |  |  |
| <b>Oil Seal Set</b>           |         |  |  |
| ProX .....                    | 249-257 |  |  |
| Winderosa .....               | 275-277 |  |  |
| <b>On Board Charger</b>       |         |  |  |
| Genius.....                   | 201-202 |  |  |
| <b>Outboard Engine Oil</b>    |         |  |  |
| Klotz .....                   | 340     |  |  |
| <b>Oxidation Remover</b>      |         |  |  |
| Bio-Kleen.....                | 327     |  |  |
|                               |         |  |  |
| <b>Paddle</b>                 |         |  |  |
| Airhead.....                  | 96-98   |  |  |
| <b>Pail Pump</b>              |         |  |  |
| Maxima.....                   | 337     |  |  |
| <b>Paint Polish</b>           |         |  |  |
| Liquid Performance .....      | 358     |  |  |
| <b>Pal Nuts</b>               |         |  |  |
| .....                         | 464     |  |  |
| <b>Paste Wax</b>              |         |  |  |
| S100.....                     | 320     |  |  |
| <b>Penetrant Lube</b>         |         |  |  |
| Maxima.....                   | 336     |  |  |
| PJ1 .....                     | 352     |  |  |
| <b>Performance Tool</b>       |         |  |  |
| 1/2 Dr. Extensions .....      | 421     |  |  |
| 1/2 Dr. Sockets .....         | 422     |  |  |
| 1/4 Inch Adapter.....         | 419     |  |  |
| 3 Jaw Puller.....             | 441     |  |  |
| Adapter.....                  | 419     |  |  |
| Allen Key .....               | 423     |  |  |
| Allen Wrench.....             | 423     |  |  |
| Angle Grinder .....           | 430     |  |  |
| Ball End Allen Set .....      | 424     |  |  |
| Ball Pein Hammer .....        | 424     |  |  |
| Battery Terminal Cleaner..... | 438     |  |  |
| Bearing And Race Driver ..... | 433     |  |  |
| Bolt Assortment.....          | 446     |  |  |
| Bolt Sizing Tool.....         | 433     |  |  |
| Break Away Knife .....        | 428     |  |  |
| Brush.....                    | 430     |  |  |
| C Clamp .....                 | 426     |  |  |
| Cable Ties .....              | 432     |  |  |
| Channel Lock Pliers .....     | 425     |  |  |
| Chisel Set.....               | 429     |  |  |
| Circuit Tester .....          | 438     |  |  |
| Claw Retriever.....           | 437     |  |  |
| Combination Wrench.....       | 428     |  |  |
| Compression Tester .....      | 444     |  |  |
| Creeper .....                 | 415     |  |  |
| Crimping Tool .....           | 426     |  |  |
| Cupped Wire Brush.....        | 436     |  |  |
| Cylinder Hone .....           | 438     |  |  |
| Deep Sockets .....            | 419     |  |  |
| Digital Caliper.....          | 432     |  |  |
| Drain Pan .....               | 415     |  |  |
| Drill Bit.....                | 429     |  |  |
| Duct Tape .....               | 440     |  |  |
| Emergency Charger .....       | 442     |  |  |
| Extensions.....               | 419     |  |  |
| Extractor Set .....           | 430     |  |  |
| Feeler Gauge .....            | 433     |  |  |
| Flashlight.....               | 431     |  |  |
| Flex Socket.....              | 419     |  |  |
| Folding Knife .....           | 428     |  |  |
| Funnel .....                  | 453     |  |  |
| Fuse Assortment.....          | 446     |  |  |
| Gasket Scraper .....          | 429     |  |  |
| Grease Gun.....               | 383,414 |  |  |
| Hammer .....                  | 424     |  |  |
| Hardware Assortments.....     | 446     |  |  |
|                               |         |  |  |
| Head Lamp.....                | 431     |  |  |
| Hex Bit Sockets .....         | 422     |  |  |
| Impact Driver .....           | 424     |  |  |
| Laser Pointer .....           | 431     |  |  |
| Magnetic Retriever .....      | 437     |  |  |
| Magnetic Tray .....           | 438     |  |  |
| Mechanic Gloves.....          | 438     |  |  |
| Mini Fuse Assortment .....    | 433     |  |  |
| Mini Sledge .....             | 424     |  |  |
| Multi Meter .....             | 438     |  |  |
| Multi Tool .....              | 426     |  |  |
| Nut Assortment .....          | 446     |  |  |
| Nut Splitter .....            | 441     |  |  |
| Oil Filter Pliers.....        | 425     |  |  |
| Oil Filter Wrench.....        | 425     |  |  |
| Pick .....                    | 429     |  |  |
| Piston Ring Compressor .....  | 437     |  |  |
| Piston Ring Installer .....   | 437     |  |  |
| Plastic Caliber .....         | 432     |  |  |
| Pliers .....                  | 424     |  |  |
| Pocket Flashlight .....       | 431     |  |  |
| Pocket Screwdriver.....       | 427     |  |  |
| Punch Set.....                | 429     |  |  |
| Ratchet.....                  | 418     |  |  |
| Ratchet Strap .....           | 406     |  |  |
| Ratchet Wrench.....           | 418     |  |  |
| Riveter Set.....              | 437     |  |  |
| Roll Around Stool .....       | 436     |  |  |
| Rubber Mallet .....           | 424     |  |  |
| Scraper.....                  | 429     |  |  |
| Screw Assortment .....        | 446     |  |  |
| Screwdriver .....             | 427     |  |  |
| Screwdriver Set.....          | 427     |  |  |
| Seal Pick .....               | 429     |  |  |
| Size Catcher.....             | 433     |  |  |
| Snap Ring Assortment .....    | 446     |  |  |
| Socket Adapter.....           | 419     |  |  |
| Socket Rail .....             | 418     |  |  |
| Sockets.....                  | 418     |  |  |
| Spark Plug Gaper.....         | 433     |  |  |
| Spark Plug Socket.....        | 441     |  |  |
| Spark Tester .....            | 439     |  |  |
| Spotlight .....               | 430     |  |  |
| Stapler.....                  | 430     |  |  |
| Star Bit Sockets.....         | 422     |  |  |
| Step Drill Set .....          | 429     |  |  |
| Stubby Bit Driver .....       | 427     |  |  |
| Swivel Mirror.....            | 438     |  |  |
| T Handle Hex Key Set.....     | 423     |  |  |
| Tape Measure .....            | 432     |  |  |
| Tappet Feeler Gauge.....      | 433     |  |  |
| Torque Wrench.....            | 427     |  |  |
| U-Joint Socket.....           | 419     |  |  |
| Utility Knife .....           | 428     |  |  |
| Voltage Checker .....         | 438     |  |  |
| Washer Assortment.....        | 446     |  |  |
| Wire Brush .....              | 436     |  |  |
| Wire Pliers.....              | 426     |  |  |
| Wobble Extension Set.....     | 419     |  |  |
| Work Light .....              | 430     |  |  |
| Zip Ties.....                 | 432     |  |  |

|                                  |         |  |  |
|----------------------------------|---------|--|--|
| <b>Perma-Lock Thread Locker</b>  |         |  |  |
| JB Weld .....                    | 373     |  |  |
| <b>Permatex</b>                  |         |  |  |
| Anti Seize Lubricant .....       | 380     |  |  |
| Battery Cleaner .....            | 378     |  |  |
| Blue Silicone .....              | 380     |  |  |
| Brake Cleaner .....              | 378     |  |  |
| Chain Lube.....                  | 378     |  |  |
| Engine Degreaser .....           | 378     |  |  |
| Fast Orange .....                | 379     |  |  |
| Hand Cleaner .....               | 379     |  |  |
| Hand Soap .....                  | 379     |  |  |
| Non-Chlorinated Brake Clean .... | 380     |  |  |
| Rubber Gloves .....              | 379     |  |  |
| Thread Lock Gel.....             | 380     |  |  |
| Thread Locker .....              | 380     |  |  |
| Ultra Black.....                 | 380     |  |  |
| White Lithium Grease.....        | 378     |  |  |
| <b>Personal Floats</b>           |         |  |  |
| Airhead.....                     | 80-86   |  |  |
| Sports Stuff .....               | 130-132 |  |  |
| <b>Pfd</b>                       |         |  |  |
| Airhead.....                     | 12-16   |  |  |
| <b>Pick</b>                      |         |  |  |
| Performance Tool .....           | 429     |  |  |
| <b>Pincers</b>                   |         |  |  |
| Motion Pro.....                  | 445     |  |  |
| <b>Piston</b>                    |         |  |  |
| ProX .....                       | 249-257 |  |  |
| Wiseco .....                     | 240-246 |  |  |
| WSM .....                        | 258-265 |  |  |
| <b>Piston Kits</b>               |         |  |  |
| ProX .....                       | 249-257 |  |  |
| Wiseco .....                     | 240-246 |  |  |
| WSM .....                        | 266-269 |  |  |
| <b>Piston Pin</b>                |         |  |  |
| ProX .....                       | 249-257 |  |  |
| Wiseco .....                     | 240-246 |  |  |
| <b>Piston Ring</b>               |         |  |  |
| ProX .....                       | 249-257 |  |  |
| Wiseco .....                     | 240-246 |  |  |
| WSM .....                        | 258-265 |  |  |
| <b>Piston Ring Compressor</b>    |         |  |  |
| Performance Tool .....           | 437     |  |  |
| <b>Piston Ring Installer</b>     |         |  |  |
| Performance Tool .....           | 437     |  |  |
| <b>Pivot Head Wrench</b>         |         |  |  |
| Motion Pro.....                  | 417     |  |  |
| <b>PJ1</b>                       |         |  |  |
| 2 Stroke Oil .....               | 348     |  |  |
| Air Filter Cleaner .....         | 349     |  |  |
| Assembly Lube.....               | 352     |  |  |
| Brake Cleaner .....              | 350     |  |  |
| Cable Lubricant .....            | 352     |  |  |
| Carburetor Cleaner .....         | 350     |  |  |
| Contact Cleaner.....             | 350     |  |  |
| Engine Case Paint.....           | 351     |  |  |
| Engine Oil.....                  | 348     |  |  |
| Exhaust Paint .....              | 351     |  |  |
| Fog Blocker .....                | 352     |  |  |
| Injection Oil .....              | 348     |  |  |
| Injector Cleaner.....            | 349     |  |  |
| Leather Renew And Protect.....   | 350     |  |  |
| Octane Booster .....             | 349     |  |  |
| Penetrant Lube.....              | 352     |  |  |
| Porcelain Epoxy.....             | 351     |  |  |
| Spray Wash .....                 | 350     |  |  |
| Super Cleaner .....              | 350     |  |  |
| Synthetic Engine Oil.....        | 348     |  |  |
| Wrinkle Paint .....              | 351     |  |  |
| <b>Plastic Caliber</b>           |         |  |  |
| Performance Tool .....           | 432     |  |  |
| <b>Plastic Repair Kit</b>        |         |  |  |
| Threebond.....                   | 365     |  |  |
| <b>Plastic Weld Epoxy</b>        |         |  |  |
| JB Weld.....                     | 368     |  |  |
| <b>Pliers</b>                    |         |  |  |
| Performance Tool .....           | 424     |  |  |
| <b>Pocket Flashlight</b>         |         |  |  |
| Performance Tool .....           | 431     |  |  |
| <b>Pocket Screwdriver</b>        |         |  |  |
| Performance Tool .....           | 427     |  |  |
| <b>Polishing Ball</b>            |         |  |  |
| Bio-Kleen.....                   | 326     |  |  |
| <b>Polishing Soap</b>            |         |  |  |
| S100.....                        | 322     |  |  |
| <b>Poly Tarp</b>                 |         |  |  |
| Erickson .....                   | 455     |  |  |
| <b>Poly Wax</b>                  |         |  |  |
| Liquid Performance .....         | 359     |  |  |
| <b>Pong Float</b>                |         |  |  |
| Airhead.....                     | 81      |  |  |
| <b>Pop-Off Valve</b>             |         |  |  |
| Mikuni.....                      | 299     |  |  |
| <b>Porcelain Epoxy</b>           |         |  |  |
| PJ1 .....                        | 351     |  |  |
| <b>Post Style Lights</b>         |         |  |  |
| .....                            | 466     |  |  |
| <b>Power Outlet</b>              |         |  |  |
| SPI .....                        | 442     |  |  |
| <b>Power Sonic</b>               |         |  |  |
| Batteries .....                  | 179-181 |  |  |
| Maintenance Free Battery ...     | 179-180 |  |  |
| <b>Primer</b>                    |         |  |  |
| .....                            | 315     |  |  |
| <b>Primer Bulb</b>               |         |  |  |
| .....                            | 315     |  |  |
| <b>Primer Kit</b>                |         |  |  |
| .....                            | 315     |  |  |
| <b>Progrip</b>                   |         |  |  |
| Handlebar Grips .....            | 159     |  |  |
| <b>ProX</b>                      |         |  |  |
| Cam Chain .....                  | 249-257 |  |  |
| Circlips .....                   | 249-257 |  |  |
| Connecting Rod .....             | 249-257 |  |  |
| Crank Bearings .....             | 249-257 |  |  |
| Crank Pin .....                  | 249-257 |  |  |
| Crank Web.....                   | 249-257 |  |  |
| Main Bearings .....              | 249-257 |  |  |
| Oil Seal Set .....               | 249-257 |  |  |
| Piston .....                     | 249-257 |  |  |
| Piston Kits .....                | 249-257 |  |  |
| Piston Pin.....                  | 249-257 |  |  |
| Piston Ring.....                 | 249-257 |  |  |
| Rings .....                      | 249-257 |  |  |
| Rod Kit .....                    | 249-257 |  |  |
| Seals .....                      | 249-257 |  |  |
| <b>Pulser Coil</b>               |         |  |  |
| WSM .....                        | 219-223 |  |  |
| <b>Punch Set</b>                 |         |  |  |
| Performance Tool .....           | 429     |  |  |
| <b>Pvc Repair Kit</b>            |         |  |  |
| Sports Stuff .....               | 138     |  |  |
| <b>Pwc Covers</b>                |         |  |  |
| Classic Accessories .....        | 152-156 |  |  |
| <b>Pwc Engine Oil</b>            |         |  |  |
| Maxima.....                      | 332     |  |  |
| <b>Pwc Fenders</b>               |         |  |  |
| Jet Logic.....                   | 34      |  |  |
| <b>Pyramidal Washers</b>         |         |  |  |
| .....                            | 465     |  |  |

## Q

|                               |     |
|-------------------------------|-----|
| <b>Quart Pump</b>             |     |
| Lubrimatic.....               | 382 |
| <b>Quick Connect Coupling</b> |     |
| Motion Pro.....               | 316 |
| <b>Quick Connector</b>        |     |
| Sports Stuff.....             | 137 |
| <b>Quick Detailing Kit</b>    |     |
| Liquid Performance.....       | 358 |
| <b>Quick Epoxy</b>            |     |
| JB Weld.....                  | 367 |
| <b>Quick Shine</b>            |     |
| Bike Magik.....               | 324 |
| Bio-Kleen.....                | 328 |

## R

|                           |         |
|---------------------------|---------|
| <b>Radiator Stop Leak</b> |         |
| JB Weld.....              | 370     |
| <b>Rat Pak</b>            |         |
| Ancra.....                | 389     |
| <b>Ratchet</b>            |         |
| Performance Tool.....     | 418     |
| <b>Ratchet Strap</b>      |         |
| Ancra.....                | 388-389 |
| Buyers.....               | 405     |
| Erickson.....             | 390-395 |
| Highlands.....            | 407-410 |
| Performance Tool.....     | 406     |
| <b>Ratchet Wrench</b>     |         |
| Performance Tool.....     | 418     |
| <b>Ratio Rite</b>         |         |
| .....                     | 453     |
| <b>Rca Jack Splitter</b>  |         |
| SPI.....                  | 442     |
| <b>Rebuild Kit</b>        |         |
| WSM.....                  | 266-269 |
| <b>Recovery Strap</b>     |         |
| Erickson.....             | 397     |
| <b>Rectifiers</b>         |         |
| Ricks Motorsports.....    | 224-225 |
| <b>Reed Gaskets</b>       |         |
| WSM.....                  | 290-293 |
| <b>Regulator</b>          |         |
| Ricks Motorsports.....    | 224-225 |
| Wild Boar.....            | 214-217 |
| <b>Relay</b>              |         |
| WSM.....                  | 218     |
| <b>Remove All</b>         |         |
| Bio-Kleen.....            | 328     |
| <b>Renew Polish</b>       |         |
| Bio-Kleen.....            | 326     |
| <b>Repair Manual</b>      |         |
| Clymer.....               | 17-19   |

|                                  |         |
|----------------------------------|---------|
| <b>Replacement Carpet</b>        |         |
| .....                            | 465     |
| <b>Rescue Bag</b>                |         |
| Airhead.....                     | 39      |
| <b>Retractable Ratchet Strap</b> |         |
| Erickson.....                    | 390     |
| Highlands.....                   | 408     |
| <b>Reverse Cables</b>            |         |
| WSM.....                         | 161-162 |
| <b>Ricks Motorsports</b>         |         |
| Rectifiers.....                  | 224-225 |
| Regulator.....                   | 224-225 |
| Stator.....                      | 224-225 |
| <b>Ring</b>                      |         |
| WSM.....                         | 258-265 |
| <b>Ring Set</b>                  |         |
| WSM.....                         | 258-265 |
| <b>Ring Terminal</b>             |         |
| .....                            | 205     |
| <b>Rings</b>                     |         |
| ProX.....                        | 249-257 |
| Wiseco.....                      | 240-246 |
| <b>River Tube</b>                |         |
| Airhead.....                     | 83      |
| <b>Riveter Set</b>               |         |
| Performance Tool.....            | 437     |
| <b>Rod Kit</b>                   |         |
| Hot Rods.....                    | 271     |
| ProX.....                        | 249-257 |
| WSM.....                         | 270     |
| <b>Roll Around Stool</b>         |         |
| Performance Tool.....            | 436     |
| <b>Roller Guide On</b>           |         |
| Shipshape.....                   | 466     |
| <b>Roller Shaft</b>              |         |
| .....                            | 464     |
| <b>Rollers</b>                   |         |
| Yates Rubber.....                | 462-463 |
| <b>Rope Floats</b>               |         |
| Kwik Tek.....                    | 38      |
| <b>Rope Ratchet</b>              |         |
| Erickson.....                    | 403     |
| <b>Rtv Sealant</b>               |         |
| Threebond.....                   | 363     |
| <b>Rubber Adhesive</b>           |         |
| Threebond.....                   | 364     |
| <b>Rubber Dampener</b>           |         |
| WSM.....                         | 236     |
| <b>Rubber Gloves</b>             |         |
| Permatex.....                    | 379     |
| <b>Rubber Handle Tie Downs</b>   |         |
| Erickson.....                    | 392-393 |
| <b>Rubber Mallet</b>             |         |
| Performance Tool.....            | 424     |
| <b>Rubber Tarp Strap</b>         |         |
| Erickson.....                    | 401,456 |
| <b>Rust Preventative Coating</b> |         |
| Bel-Ray.....                     | 341     |

## S

|                                |         |
|--------------------------------|---------|
| <b>S100</b>                    |         |
| Corrosion Protectant.....      | 321     |
| Detail + Wax.....              | 322     |
| Detailing Swabs.....           | 323     |
| Drying Towel.....              | 321     |
| Engine Brightener.....         | 322     |
| Paste Wax.....                 | 320     |
| Polishing Soap.....            | 322     |
| Special Surface Cleaner.....   | 323     |
| Total Care Kit.....            | 320     |
| Wheel Cleaner.....             | 321     |
| <b>Safety Chain</b>            |         |
| Fulton.....                    | 461     |
| <b>Safety Glasses</b>          |         |
| Elvex.....                     | 434     |
| <b>Salt Cleaner</b>            |         |
| Bio-Kleen.....                 | 329     |
| <b>Sand Anchor</b>             |         |
| Atlantis.....                  | 49      |
| Jet Logic.....                 | 32      |
| <b>Scraper</b>                 |         |
| Performance Tool.....          | 429     |
| <b>Screw Assortment</b>        |         |
| Performance Tool.....          | 446     |
| <b>Screwdriver</b>             |         |
| Performance Tool.....          | 427     |
| <b>Screwdriver Set</b>         |         |
| Performance Tool.....          | 427     |
| <b>Seal 'N' Air</b>            |         |
| Threebond.....                 | 365     |
| <b>Seal Pick</b>               |         |
| Performance Tool.....          | 429     |
| <b>Sealing Grease</b>          |         |
| K&N.....                       | 357     |
| <b>Seals</b>                   |         |
| ProX.....                      | 249-257 |
| Wiseco.....                    | 240-246 |
| <b>Seat Cover</b>              |         |
| Classic Accessories.....       | 153     |
| <b>Semi Synthetic Gear Oil</b> |         |
| Bel-Ray.....                   | 343     |
| <b>Shaker Siphon</b>           |         |
| Flo Tools.....                 | 452     |
| <b>Shipshape</b>               |         |
| Bunk Guide On.....             | 466     |
| Roller Guide On.....           | 466     |
| <b>Silicone Detailer</b>       |         |
| Maxima.....                    | 336     |
| <b>Silicone Liquid Gasket</b>  |         |
| Threebond.....                 | 364     |
| <b>Silicone Lubricant</b>      |         |
| Bel-Ray.....                   | 342     |
| <b>Silicone Sealant</b>        |         |
| Threebond.....                 | 365     |
| <b>Siphon Pump</b>             |         |
| .....                          | 415     |
| <b>Size Catcher</b>            |         |
| Performance Tool.....          | 433     |
| <b>Skim Wakeboard</b>          |         |
| Airhead.....                   | 57      |
| <b>Sled Brite</b>              |         |
| Anti Fog Cleaner.....          | 325     |
| Leather Cleaner.....           | 325     |
| Metal Polish.....              | 325     |

|                                 |         |                                      |         |                             |         |
|---------------------------------|---------|--------------------------------------|---------|-----------------------------|---------|
| <b>Slow Jets</b>                |         | <b>Sports Stuff</b>                  |         | <b>Steering Cables</b>      |         |
| Keihin .....                    | 297     | Booster Ball .....                   | 116     | WSM .....                   | 166-170 |
| <b>Slow Speed Jet</b>           |         | Cooler Caddy .....                   | 135     | <b>Step Drill Set</b>       |         |
| Mikuni .....                    | 298     | Electric Air Pump .....              | 138     | Performance Tool .....      | 429     |
| <b>Snap Hook</b>                |         | Floating Trampoline .....            | 136     | <b>Step Less Clamps</b>     |         |
| Fulton .....                    | 461     | Hand Pump .....                      | 138     | Motion Pro .....            | 445     |
| <b>Snap Ring Assortment</b>     |         | Personal Floats .....                | 130-132 | <b>Stop Watch</b>           |         |
| Performance Tool .....          | 446     | Pvc Repair Kit .....                 | 138     | Hardline .....              | 454     |
| <b>Snap Ring Pliers</b>         |         | Quick Connector .....                | 137     | <b>Storage Containers</b>   |         |
| Motion Pro .....                | 437     | Tow Behinds .....                    | 111-133 | VP Racing .....             | 448-449 |
| <b>Sno Stuff</b>                |         | Water Sports Gloves .....            | 137     | <b>Strap Hanger</b>         |         |
| Universal Flywheel Puller ..... | 441     | <b>Spotlight</b>                     |         | Erickson .....              | 397     |
| <b>Socket Adapter</b>           |         | Performance Tool .....               | 430     | <b>Stubby Bit Driver</b>    |         |
| Performance Tool .....          | 419     | <b>Spray Cleaner</b>                 |         | Performance Tool .....      | 427     |
| <b>Socket Rail</b>              |         | Bike Spirits .....                   | 386     | <b>Suction Cup Tie Down</b> |         |
| Performance Tool .....          | 418     | <b>Spray Cleaner And Polish</b>      |         | Airhead .....               | 43      |
| <b>Sockets</b>                  |         | Liquid Performance .....             | 358     | <b>Sunglasses Floats</b>    |         |
| Performance Tool .....          | 418     | <b>Spray Wash</b>                    |         | Atlantis .....              | 48      |
| <b>Soft Hook Extension</b>      |         | PJ1 .....                            | 350     | <b>SUP Cargo Net</b>        |         |
| Ancra .....                     | 389     | <b>Spring Hook</b>                   |         | Airhead .....               | 41      |
| <b>Solar Charger</b>            |         | SPI .....                            | 439     | <b>SUP Carrier</b>          |         |
| Genius .....                    | 203     | <b>Spring Latch</b>                  |         | Airhead .....               | 40      |
| <b>Solenoid</b>                 |         | Buyers .....                         | 462     | <b>SUP Paddle</b>           |         |
| Wild Boar .....                 | 214-217 | <b>Spring Tool</b>                   |         | Airhead .....               | 96-97   |
| <b>Spark Plug Gaper</b>         |         | .....                                | 439     | <b>SUP Stabilizers</b>      |         |
| Performance Tool .....          | 433     | <b>Squirt Gun</b>                    |         | Airhead .....               | 40      |
| <b>Spark Plug Socket</b>        |         | Airhead .....                        | 44-45   | <b>Super Bn Parts</b>       |         |
| Performance Tool .....          | 441     | <b>Sta-Dri</b>                       |         | Mikuni .....                | 301     |
| <b>Spark Plug Wrench</b>        |         | Fuel Dryer .....                     | 453     | <b>Super Cleaner</b>        |         |
| Emgo .....                      | 441     | <b>Stainless Steel Ratchet Strap</b> |         | PJ1 .....                   | 350     |
| <b>Spark Tester</b>             |         | Highlands .....                      | 409     | <b>Super Glue</b>           |         |
| Performance Tool .....          | 439     | <b>Stake Anchor</b>                  |         | Threebond .....             | 364     |
| <b>Special Surface Cleaner</b>  |         | Atlantis .....                       | 49      | <b>Super Suds Wash</b>      |         |
| S100 .....                      | 323     | <b>Stand Up Paddle Board</b>         |         | Bike Magik .....            | 324     |
| <b>Speed Wax</b>                |         | Airhead .....                        | 89-94   | Bio-Kleen .....             | 329     |
| Maxima .....                    | 335     | <b>Stapler</b>                       |         | <b>Switches</b>             |         |
| <b>SPI</b>                      |         | Performance Tool .....               | 430     | WSM .....                   | 206-207 |
| Cam Lock Strap .....            | 405     | <b>Star Bit Sockets</b>              |         | <b>Swivel Mirror</b>        |         |
| Hand Mirror .....               | 21      | Performance Tool .....               | 422     | Performance Tool .....      | 438     |
| Jet Carrier .....               | 444     | <b>Star Tron</b>                     |         | <b>Syncpro Carb Tool</b>    |         |
| Power Outlet .....              | 442     | Coolant .....                        | 356     | Motion Pro .....            | 444     |
| Rca Jack Splitter .....         | 442     | Fuel Treatment .....                 | 356     | <b>Synthetic Engine Oil</b> |         |
| Spring Hook .....               | 439     | Gas Additive .....                   | 356     | PJ1 .....                   | 348     |
| Tie Down Strap .....            | 405     | <b>Start/Stop Switch</b>             |         | <b>Sython Hose</b>          |         |
| Wear Ring .....                 | 238     | WSM .....                            | 206-207 | .....                       | 415     |
| Wrist Mirror .....              | 21      | <b>Starter Drive</b>                 |         |                             |         |
| <b>Spider Grips</b>             |         | Wild Boar .....                      | 208-213 |                             |         |
| Handlebar Grips .....           | 160     | <b>Starter Rebuild Kit</b>           |         |                             |         |
|                                 |         | Wild Boar .....                      | 208-213 |                             |         |
|                                 |         | <b>Starter Relay</b>                 |         |                             |         |
|                                 |         | WSM .....                            | 218     |                             |         |
|                                 |         | <b>Starters</b>                      |         |                             |         |
|                                 |         | Wild Boar .....                      | 208-213 |                             |         |
|                                 |         | <b>Stator</b>                        |         |                             |         |
|                                 |         | Ricks Motorsports .....              | 224-225 |                             |         |
|                                 |         | WSM .....                            | 219-223 |                             |         |

## T

|                                |         |
|--------------------------------|---------|
| <b>T Fitting</b>               | 316     |
| <b>T Handle Hex Key Set</b>    |         |
| Performance Tool               | 423     |
| <b>T Handle Rack</b>           |         |
| Motion Pro                     | 436     |
| <b>T Handle Spinner Wrench</b> |         |
| Motion Pro                     | 416     |
| <b>T Handle Wrench</b>         |         |
| Motion Pro                     | 416,436 |
| <b>Taillight Bracket</b>       |         |
|                                | 464     |
| <b>Tape Measure</b>            |         |
| Performance Tool               | 432     |
| <b>Tappet Feeler Gauge</b>     |         |
| Performance Tool               | 433     |
| <b>Tarps</b>                   |         |
| Erickson                       | 455     |
| <b>Telescoping Paddle</b>      |         |
| Airhead                        | 98      |
| <b>Terminal Cleaner</b>        |         |
| Battery Tender                 | 197     |
| <b>The Orb</b>                 |         |
| Airhead                        | 95      |
| <b>Thread Lock Gel</b>         |         |
| Permatex                       | 380     |
| <b>Thread Locker</b>           |         |
| Permatex                       | 380     |
| Threebond                      | 366     |
| <b>Threebond</b>               |         |
| Adhesive Gel                   | 364     |
| Gasket Maker                   | 363     |
| Glue                           | 364     |
| Grip Lock                      | 365     |
| Hi Temp Thread Locker          | 366     |
| Plastic Repair Kit             | 365     |
| Rtv Sealant                    | 363     |
| Rubber Adhesive                | 364     |
| Seal 'N' Air                   | 365     |
| Silicone Liquid Gasket         | 364     |
| Silicone Sealant               | 365     |
| Super Glue                     | 364     |
| Thread Locker                  | 366     |
| <b>Throttle Cables</b>         |         |
| WSM                            | 163-165 |
| <b>Throttle Shaft Rebuild</b>  |         |
| Mikuni                         | 299     |
| <b>Tie Down Strap</b>          |         |
| Ancra                          | 388-389 |
| Erickson                       | 390-395 |
| SPI                            | 405     |
| <b>Tie Off</b>                 |         |
| Erickson                       | 404     |
| <b>Tilt Cables</b>             |         |
| WSM                            | 171     |
| <b>Tire Strap</b>              |         |
| Erickson                       | 404     |
| <b>Titanium Wrenches</b>       |         |
| Motion Pro                     | 417     |
| <b>Top End Bearing</b>         |         |
| Wiseco                         | 240-246 |
| <b>Top End Gasket Kit</b>      |         |
| Cometic                        | 273-274 |
| Winderosa                      | 275-276 |
| Wiseco                         | 240-246 |

|                                |         |
|--------------------------------|---------|
| <b>Top End Kits</b>            |         |
| Wiseco                         | 240-246 |
| WSM                            | 266-269 |
| <b>Topkote Finishing Spray</b> |         |
| Liquid Performance             | 360     |
| <b>Torque Wrench</b>           |         |
| Performance Tool               | 427     |
| <b>Total Care Kit</b>          |         |
| S100                           | 320     |
| <b>Tow Behinds</b>             |         |
| Airhead                        | 62-78   |
| Sports Stuff                   | 111-133 |
| <b>Tow Ropes</b>               |         |
| Airhead                        | 99-106  |
| Erickson                       | 397     |
| <b>Towable Covers</b>          |         |
| Classic Accessories            | 148-152 |
| <b>Training Ski's</b>          |         |
| Airhead                        | 60      |
| <b>Transmission Funnel</b>     |         |
| Flo Tools                      | 451     |
| <b>Transom Tie Down</b>        |         |
| Erickson                       | 401     |
| <b>Transom/Bow Eyelet</b>      |         |
| Erickson                       | 402     |
| <b>Transom/Bow U Bolt</b>      |         |
| Erickson                       | 402     |
| <b>Tube Anchor</b>             |         |
| Jet Logic                      | 32      |
| <b>Tubes</b>                   |         |
| Airhead                        | 62-78   |
| <b>Tygon Line</b>              |         |
|                                | 317     |

## U

|                                  |     |
|----------------------------------|-----|
| <b>U-Joint Socket</b>            |     |
| Performance Tool                 | 419 |
| <b>Ultimate Black Silicone</b>   |     |
| JB Weld                          | 372 |
| <b>Ultra Black</b>               |     |
| Permatex                         | 380 |
| <b>Uni</b>                       |     |
| Air Filter Cleaner               | 356 |
| Air Filter Maintenance Kit       | 356 |
| Air Filter Oil                   | 356 |
| <b>Universal Flywheel Puller</b> |     |
| Sno Stuff                        | 441 |
| <b>USB Charger</b>               |     |
| Battery Tender                   | 197 |
| <b>Utility Knife</b>             |     |
| Performance Tool                 | 428 |

## V

|                          |         |
|--------------------------|---------|
| <b>Vent Cap</b>          |         |
| VP Racing                | 449     |
| <b>Vinyl Conditioner</b> |         |
| Bio-Kleen                | 327     |
| <b>Visu Filter</b>       |         |
| Fuel Filter              | 314-315 |
| In-Line Fuel Filter      | 314-315 |
| <b>Voltage Checker</b>   |         |
| Performance Tool         | 438     |
| <b>Voltage Regulator</b> |         |
| WSM                      | 226-229 |
| <b>VP Racing</b>         |         |
| Container Hose           | 449     |
| Containers               | 448-449 |
| Storage Containers       | 448-449 |
| Vent Cap                 | 449     |

## W

|                                   |       |
|-----------------------------------|-------|
| <b>Wake Trainer</b>               |       |
| Airhead                           | 61    |
| <b>Wakeboard</b>                  |       |
| Airhead                           | 52-57 |
| <b>Washer Assortment</b>          |       |
| Performance Tool                  | 446   |
| <b>Water Cannon</b>               |       |
| Airhead                           | 44-45 |
| <b>Water Remover</b>              |       |
| Gold Eagle                        | 355   |
| <b>Water Removing Funnel</b>      |       |
| Mr. Funnel                        | 450   |
| <b>Water Ski's</b>                |       |
| Airhead                           | 60    |
| <b>Water Sports Gloves</b>        |       |
| Sports Stuff                      | 137   |
| <b>Water Weld Epoxy</b>           |       |
| JB Weld                           | 369   |
| <b>Waterproof Camera Case</b>     |       |
| Dry Pak                           | 28    |
| <b>Waterproof Cell Phone Case</b> |       |
| Dry Pak                           | 25-30 |
| <b>Waterproof Gear Bag</b>        |       |
| Dry Pak                           | 29-30 |
| <b>Waterproof Grease</b>          |       |
| ACF-50                            | 385   |
| Bel-Ray                           | 342   |
| Bel-Ray                           | 345   |
| Maxima                            | 337   |
| <b>Wear Ring</b>                  |       |
| SPI                               | 238   |
| WSM                               | 238   |
| <b>Wheel Cleaner</b>              |       |
| S100                              | 321   |
| <b>Wheel Gel</b>                  |       |
| Bio-Kleen                         | 329   |

|                             |         |
|-----------------------------|---------|
| <b>Whistle</b>              |         |
| Jet Logic.....              | 33      |
| <b>White Lithium Grease</b> |         |
| Lubrimatic.....             | 381     |
| Permatex.....               | 378     |
| <b>White Silicone</b>       |         |
| JB Weld.....                | 371     |
| <b>Wild Boar</b>            |         |
| Regulator.....              | 214-217 |
| Solenoid.....               | 214-217 |
| Starter Drive.....          | 208-213 |
| Starter Rebuild Kit.....    | 208-213 |
| Starters.....               | 208-213 |
| <b>Winch Cable</b>          |         |
| Fulton.....                 | 461     |
| <b>Winch Strap</b>          |         |
| Erickson.....               | 399,461 |
| <b>Winderosa</b>            |         |
| Carb Rebuild Kit.....       | 304     |
| Counter Balance Seal.....   | 277     |
| Fuel Pump Rebuild.....      | 304     |
| Full Gasket Set.....        | 275-276 |
| Gasket Kit.....             | 275-276 |
| Oil Seal Set.....           | 275-277 |
| Top End Gasket Kit.....     | 275-276 |
| <b>Windshield Cleaner</b>   |         |
| Bike Brite.....             | 375     |
| <b>Wing Mirror</b>          |         |
| Cipa.....                   | 143     |
| <b>Wipes</b>                |         |
| Bike Brite.....             | 375     |
| <b>Wire Brush</b>           |         |
| Performance Tool.....       | 436     |
| <b>Wire Pliers</b>          |         |
| Performance Tool.....       | 426     |
| <b>Wiseco</b>               |         |
| Circlips.....               | 240-246 |
| Crank Bearings.....         | 240-246 |
| Crank Seals.....            | 240-246 |
| Gasket Kit.....             | 240-246 |
| Hour Meter.....             | 454     |
| Main Bearings.....          | 240-246 |
| Needle Bearing.....         | 240-246 |
| Piston.....                 | 240-246 |
| Piston Kits.....            | 240-246 |
| Piston Pin.....             | 240-246 |
| Piston Ring.....            | 240-246 |

|                             |         |
|-----------------------------|---------|
| Rings.....                  | 240-246 |
| Seals.....                  | 240-246 |
| Top End Bearing.....        | 240-246 |
| Top End Gasket Kit.....     | 240-246 |
| Top End Kits.....           | 240-246 |
| Wrist Pin Bearing.....      | 240-246 |
| <b>Wobble Extension Set</b> |         |
| Performance Tool.....       | 419     |
| <b>Wood Weld Epoxy</b>      |         |
| JB Weld.....                | 368     |
| <b>Work Light</b>           |         |
| Performance Tool.....       | 430     |
| <b>Wrinkle Paint</b>        |         |
| PJ1.....                    | 351     |
| <b>Wrist Mirror</b>         |         |
| SPI.....                    | 21      |
| <b>Wrist Pin Bearing</b>    |         |
| Wiseco.....                 | 240-246 |
| <b>WSM</b>                  |         |
| Alarms.....                 | 206-207 |
| Armature Coil.....          | 219-223 |
| CDI Box.....                | 230     |
| Charge Coil.....            | 219-223 |
| Coil.....                   | 219-223 |
| Connecting Rod.....         | 270     |
| Control Cables.....         | 161-172 |
| Coupler.....                | 236-237 |
| Coupler Shaft.....          | 237     |
| Dampeners.....              | 236     |
| Drive Shaft.....            | 232-235 |
| Engine Mounts.....          | 278-279 |
| Exciter Coil.....           | 219-223 |
| Ignition Coil.....          | 219-223 |
| Intake Gaskets.....         | 290-293 |
| Lighting Coil.....          | 219-223 |
| Motor Mounts.....           | 278-279 |
| Nozzle Cable.....           | 172     |
| Piston.....                 | 258-265 |
| Piston Kits.....            | 266-269 |
| Piston Ring.....            | 258-265 |
| Pulser Coil.....            | 219-223 |
| Rebuild Kit.....            | 266-269 |
| Reed Gaskets.....           | 290-293 |
| Relay.....                  | 218     |
| Reverse Cables.....         | 161-162 |
| Ring.....                   | 258-265 |
| Ring Set.....               | 258-265 |

|                        |         |
|------------------------|---------|
| Rod Kit.....           | 270     |
| Rubber Dampener.....   | 236     |
| Start/Stop Switch..... | 206-207 |
| Starter Relay.....     | 218     |
| Stator.....            | 219-223 |
| Steering Cables.....   | 166-170 |
| Switches.....          | 206-207 |
| Throttle Cables.....   | 163-165 |
| Tilt Cables.....       | 171     |
| Top End Kits.....      | 266-269 |
| Voltage Regulator..... | 226-229 |
| Wear Ring.....         | 238     |



|                                |         |
|--------------------------------|---------|
| <b>Y Fitting</b>               |         |
| .....                          | 316     |
| <b>Yates Rubber</b>            |         |
| Boat Rollers.....              | 462-463 |
| Bow Rollers.....               | 462-463 |
| Bow Stops.....                 | 462-463 |
| Rollers.....                   | 462-463 |
| <b>Yuasa</b>                   |         |
| Batteries.....                 | 174-178 |
| Battery Charger.....           | 193     |
| Battery Tester.....            | 193     |
| Jumper Cables.....             | 193     |
| Maintenance Free Battery... .. | 174-175 |



|                              |     |
|------------------------------|-----|
| <b>Zero Stretch Tow Rope</b> |     |
| Airhead.....                 | 101 |
| <b>Zip Ties</b>              |     |
| Performance Tool.....        | 432 |