

2016

TRAILER

PARTS AND ACCESSORIES



AUTOMATIC
DISTRIBUTORS

WWW.AUTODIST.COM
207.942.6769 • 800.341.1658

PATENTED TECHNOLOGY

SUPERGLIDES II

PRO

The sled and ATV glide with traction!

FEATURES:

- Features improved traction for your feet
- Sleds glide with ease; no more ripping up your plywood deck
- Traction for your ATV; no more spinning tires
- Moisture minimizing venting; prevents premature wood rot
- An industry's first; traction for your feet
- Kit lengths; 20' (8 pcs) 8.5" wide, includes 48 custom designed screws
- All boxes come with mounting hardware and mounting instructions
- Full kit Super-Glides (8 pc = 20' feet) includes screw/grommet kit)



SUPERTRAC

The #1 Multi-Purpose Tie Down System

The new SUPERTRAC is a multi-purpose, fully adjustable and lockable tie-down anchor system for use anywhere you need to tie down and secure cargo. SUPERTRAC can be installed in pick-up trucks, trailers, vans or just about anywhere you need to add an anchor point to tie down your cargo. Comes standard with 1 piece SUPERTRAC, SUPERTRAC Deck Hook, End caps and Stainless Steel Hardware.

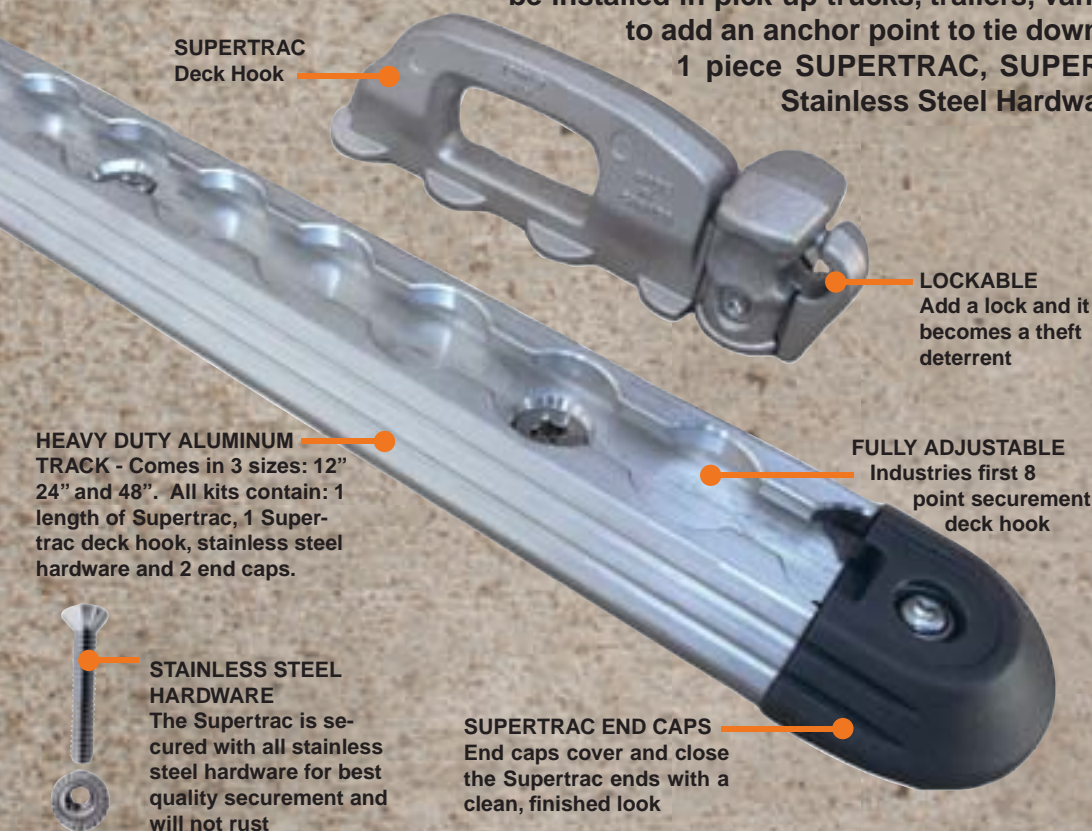

SUPERTRAC Deck Hook

LOCKABLE
Add a lock and it becomes a theft deterrent

FULLY ADJUSTABLE
Industries first 8 point securement deck hook

HEAVY DUTY ALUMINUM TRACK - Comes in 3 sizes: 12" 24" and 48". All kits contain: 1 length of Supertrac, 1 Supertrac deck hook, stainless steel hardware and 2 end caps.

STAINLESS STEEL HARDWARE
The Supertrac is secured with all stainless steel hardware for best quality securement and will not rust

SUPERTRAC END CAPS
End caps cover and close the Supertrac ends with a clean, finished look





TIRES & WHEELS

5-16

AXLES, HUBS & SPRINGS

17-38

TONGUE ACCESSORIES

39-52

HITCHES

53-76

ELECTRICAL

77-148

BRAKE PARTS

149-176

TRAILER HARDWARE

177-182

LOCKS & PINS

183-198

TOWING & LOADING

199-222

TIE DOWNS

223-248

TOOLS

249-298

CHEMICALS

299-326

NEW FOR 2016!

ELECTRICAL



TRAILER LIGHTING



TRAILER LIGHT KITS

pages 88-90



STROBE / BEACON LIGHT

page 91



LICENSE / UTILITY LIGHT

page 91



WORK / UTILITY LIGHT

page 91

TIRES & WHEELS



- tires & wheels
- axles, hubs & springs
- tongue accessories
- hitches
- electrical
- brake parts
- trailer hardware
- locks & pins
- towing & loading
- tie downs
- tools
- chemicals

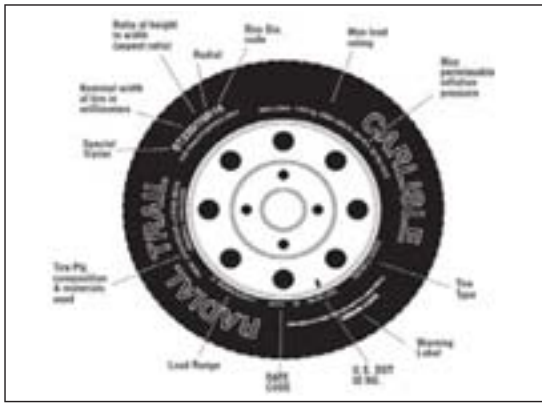

TIRE & WHEEL ASSEMBLIES (HIGH SPEED) TUBELESS

Our highway speed trailer tires are approved for over the highway use and comply with the US Department of Transportation requirements. Long lasting wrap around tread provides safe transportation.

PART #	MFG #	TIRE SIZE	# HOLES	LOAD RANGE	RIM COLOR	MAXIMUM LOAD CAPACITY LBS @ PSI	
TIRE AND WHEEL ASSEMBLIES							
691002	30027	480X8	4	B	WHITE	585 @ 60	73.70 B
691042	15516	480X8	5	B	WHITE	585 @ 60	73.70 B
692003	30062	480X8	4	C	GALVANIZED	760 @ 90	105.15 B
692043	30068	480X8	5	C	GALVANIZED	760 @ 90	106.20 B
691004	30030	570X8	4	B	WHITE	715 @ 50	97.55 B
691044	15813	570X8	5	B	WHITE	715 @ 50	97.80 B
692004	30065	570X8	4	B	GALVANIZED	715 @ 50	114.30 B
692044	30069	570X8	5	B	GALVANIZED	715 @ 50	114.30 B
692005	30064	570X8	4	C	GALVANIZED	910 @ 75	127.90 B
692045	30070	570x8	5	C	GALVANIZED	910 @ 75	123.95 B
691011	15655	18.5X8.5-8	4	C	WHITE	935 @ 50	146.35 B
691074	15621	20.5X8.5-10	4	B	WHITE	910 @ 35	157.55 B
691020	15491	20.5X8.5-10	4	C	WHITE	1100 @ 50	184.35 B
692054	32315	20.5X8.5-10	4	B	GALVANIZED	910 @ 35	188.45 B
692059	32317	20.5X8.5-10	4	C	GALVANIZED	910 @ 35	217.30 B
SPOKED RIMS IN EITHER WHITE OR GALVANIZED							
691026	42113	480X12	4	B	WHITE	785 @ 60	126.85 B
692065	30076	480X12	5	B	GALVANIZED	785 @ 60	143.15 B
692066	30073	480X12	5	C	GALVANIZED	990 @ 90	173.00 G
691030	42115	530X12	4	B	WHITE	855 @ 55	134.90 B
691070	42123	530X12	5	B	WHITE	855 @ 55	134.90 B
691032	42116	530X12	4	C	WHITE	1050 @ 80	154.45 B
691072	42124	530X12	5	C	WHITE	1050 @ 80	154.45 B
692028	30074	530X12	4	B	GALVANIZED	855 @ 55	156.50 B
692029	30077	530X12	5	B	GALVANIZED	855 @ 55	156.50 B
CUSTOM WHITE SPOKED PNEUMATIC TIRE							
691093	42130	ST175/80DX13	5	C	WHITE	1360 @ 50	201.85 B
691095	41893	ST205/75DX14	5	C	WHITE	1760 @ 50	221.45 B
691090	42136	ST215/75DX14	5	C	WHITE	1870 @ 50	230.70 B
691097	42501	ST205/75DX15	5	C	WHITE	1820 @ 50	243.95 B
CUSTOM WHITE SPOKED RADIAL TIRE							
692082	417851	ST205/75RX14	5	C	WHITE	1760 @ 50	208.95 B
692086	417861	ST215/75RX14	5	C	WHITE	1570 @ 50	204.95 B



TRAILER



LOAD STAR TIRE & WHEEL ASSEMBLIES

Computer designed tread features a radial tire appearance with bias tire's durability.
Advanced rubber compound gives longer tread wear and low rolling resistance.
Flatter tread profile allows for increased towing stability.

PART #	MFG #	TIRE SIZE	# HOLES	LOAD RANGE	RIM COLOR	MAXIMUM LOAD CAPACITY LBS @ PSI		
TIRE AND WHEEL ASSEMBLIES								
698102	30000	480X8	4	B	WHITE	590 @ 60	38.95	D
698142	30020	480X8	5	B	WHITE	590 @ 60	38.95	D
698204	30050	480X8	4	C	GALVANIZED	745 @ 90	47.95	D
698245	30070	480X8	5	C	GALVANIZED	745 @ 90	47.95	D
698104	30080	570X8	4	B	WHITE	715 @ 50	53.95	D
698144	30100	570X8	5	B	WHITE	715 @ 50	53.95	D
698208	30130	570X8	4	C	GALVANIZED	910 @ 75	64.95	D
698248	30150	570X8	5	C	GALVANIZED	910 @ 75	64.95	D
698126	30540	480X12	4	B	WHITE	780 @ 60	69.95	D
698166	30580	480X12	5	B	WHITE	780 @ 60	69.95	D
698174	30630	480X12	4	C	GALVANIZED	990 @ 90	70.95	D
698175	30670	480X12	5	C	GALVANIZED	990 @ 90	70.95	D
698130	30700	530X12	4	B	WHITE	840 @ 55	77.95	D
698170	30740	530X12	5	B	WHITE	840 @ 55	77.95	D
698172	30780	530X12	4	C	WHITE	1045 @ 80	83.95	D
698173	30820	530X12	5	C	WHITE	1045 @ 80	83.95	D
698178	30790	530X12	4	C	GALVANIZED	1045 @ 80	83.95	D
698179	30850	530X12	5	C	GALVANIZED	1045 @ 80	83.95	D
PNEUMATIC TIRE								
698190	3S140	ST175/80DX13	5	C	WHITE	1360 @ 50	115.95	D
698200	3S160	ST175/80DX13	5	C	GALVANIZED	1360 @ 50	112.95	D
698191	3S440	ST205/75DX14	5	C	WHITE	1760 @ 50	141.95	D
698192	3S550	ST215/75DX14	5	C	WHITE	1870 @ 50	153.95	D
698202	3S560	ST215/75DX14	5	C	GALVANIZED	1870 @ 50	160.95	D
698193	3S640	ST205/75DX15	5	C	WHITE	1820 @ 50	143.95	D
698201	3S650	ST205/75DX15	5	C	GALVANIZED	1820 @ 50	151.95	D
RADIAL TIRE								
698091	S1952	ST175/80RX13	5	C	GALVANIZED	1360 @ 50	129.95	D
698092	S2156	ST205/75RX14	5	C	GALVANIZED	1760 @ 50	173.95	D
698093	S2397	ST205/75RX15	5	C	GALVANIZED	1820 @ 50	184.95	D
698196	S2508	ST225/75RX15	6	C	WHITE	2150 @ 50	205.95	D



tires & wheels

axles, hubs & springs

tongue accessories

hitches

electrical

brake parts

trailer hardware

locks & pins

towing & loading

tie downs

tools

chemicals

TRAILER

TIRES & WHEELS

LOAD STAR TIRE & WHEEL ASSEMBLIES

All purpose tread design, Designed like radial tires.



- tires & wheels
- axles, hubs & springs
- tongue accessories
- hitches
- electrical
- brake parts
- trailer hardware
- locks & pins
- towing & loading
- tie downs
- tools
- chemicals

PART #	MFG #	TIRE SIZE	REPLACES	# HOLES	LOAD RANGE	RIM COLOR	MAXIMUM LOAD CAPACITY LBS @ PSI		
TIRE AND WHEEL ASSEMBLIES									
698260	3H250	215/60X8	18.5X8.5X8	4	B	WHITE	770 @ 35	76.95	D
698262	3H270	215/60X8	18.5X8.5X8	5	B	WHITE	770 @ 35	76.95	D
698264	3H290	215/60X8	18.5X8.5X8	4	C	WHITE	940 @ 50	80.95	D
698266	3H310	215/60X8	18.5X8.5X8	5	C	WHITE	940 @ 50	80.95	D
698270	3H260	215/60X8	18.5X8.5X8	4	B	GALVANIZED	770 @ 35	80.95	D
698272	3H280	215/60X8	18.5X8.5X8	5	B	GALVANIZED	770 @ 35	81.95	D
698274	3H300	215/60X8	18.5X8.5X8	4	C	GALVANIZED	940 @ 50	87.95	D
698276	3H320	215/60X8	18.5X8.5X8	5	C	GALVANIZED	940 @ 50	85.95	D
698300	3H292	215/60X8	18.5X8.5X8	4	C	SILVER	940 @ 50	84.95	D
698302	3H312	215/60X8	18.5X8.5X8	5	C	SILVER	940 @ 50	80.95	D
698280	3H330	205/65X10	20.5X8.00X10	4	B	WHITE	905 @ 35	92.95	D
698282	3H350	205/65X10	20.5X8.00X10	5	B	WHITE	905 @ 35	92.95	D
698284	3H370	205/65X10	20.5X8.00X10	4	C	WHITE	1105 @ 50	99.95	D
698286	3H390	205/65X10	20.5X8.00X10	5	C	WHITE	1105 @ 50	99.95	D
698290	3H340	205/65X10	20.5X8.00X10	4	B	GALVANIZED	905 @ 35	110.95	D
698292	3H360	205/65X10	20.5X8.00X10	5	B	GALVANIZED	905 @ 35	110.95	D
698294	3H380	205/65X10	20.5X8.00X10	4	C	GALVANIZED	1105 @ 50	117.95	D
698296	3H400	205/65X10	20.5X8.00X10	5	C	GALVANIZED	1105 @ 50	117.95	D
698298	3H440	205/65X10	20.5X8.00X10	5	D	GALVANIZED	1330 @ 50	123.95	D
698310	3H371	205/65X10	20.5X8.00X10	4	C	SILVER	1105 @ 50	97.95	D
698312	3H394	205/65X10	20.5X8.00X10	5	C	SILVER	1105 @ 50	101.95	D
698320	3H432	205/65X10	20.5X8.00X10	5	D	SILVER	1330 @ 50	109.95	D
698324	3H482	205/65X10	20.5X8.00X10	5	E	SILVER	1535 @ 50	113.95	D



WHITE RIM



GALVANIZED RIM



SILVER RIM



Lug nuts (or bolts) are tightened as shown

TRAILER

Wheel Torque Chart	Stud Size	lbs/ft
	1/2" -20	70-90
Standard Wheels	9/16" -18	110-140
	5/8" -18	125-140

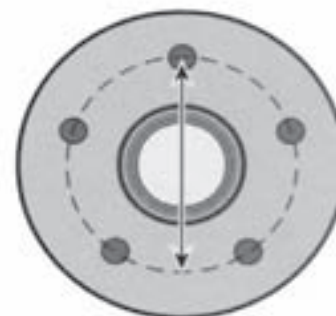

Bolt pattern is measured through center bolt circle

WHEELS

We offer a wide range of sizes and styles for most any trailer application painted wheels have e-coat and powder coat finish for a long lasting finish.



693252



693284



693270



693294

PART #	MFG #	WHEEL SIZE INCHES	BOLT	BOLT PATTERN INCHES	FITS HOLE INCHES	TIRE SIZE	SOLID / SPOKE	COLOR		
WHEELS										
693202	20001	8X3.75	4	4	2-1/2	480X8/570X8	SOLID	WHITE	16.95	D
693252	20006	8X3.75	5	4.5	2-13/16	480X8/570X8	SOLID	WHITE	16.95	D
693282	20003	8X3.75	4	4	2-1/2	480X8/570X8	SOLID	GALVANIZED	19.95	D
693284	20008	8X3.75	5	4.5	2-13/16	480X8/570X8	SOLID	GALVANIZED	19.95	D
693206	20011	8X5.375	4	4	2-1/2	16-1/2X8	SOLID	WHITE	18.95	D
693256	20016	8X5.375	5	4.5	2-13/16	16-1/2X8	SOLID	WHITE	18.95	D
693210	20021	8X7	4	4	2-1/2	18-1/2X8	SOLID	WHITE	23.95	D
693260	20026	8X7	5	4.5	2-13/16	18-1/2X8	SOLID	WHITE	23.95	D
693240	20019	8X7	4	4	2-1/2	18-1/2X8	SOLID	SILVER	23.95	D
693242	20027	8X7	5	4.5	2-13/16	18-1/2X8	SOLID	SILVER	22.95	D
693283	20023	8X7	4	4	2-1/2	18-1/2X8	SOLID	GALVANIZED	25.95	D
693285	20028	8X7	5	4.5	2-13/16	18-1/2X8	SOLID	GALVANIZED	26.95	D
693215	20035	9X4	4	4	2-1/2	690X9	SOLID	WHITE	20.95	D
693265	20038	9X4	5	4.5	2-13/16	690X9	SOLD	WHITE	20.95	D
693220	20041	10X6	4	4	2-1/2	20-1/2X10	SOLID	WHITE	34.95	D
693270	20046	10X6	5	4.5	2-13/16	20-1/2X10	SOLID	WHITE	34.95	D
693244	20042	10X6	4	4	2-1/2	20-1/2X10	SOLID	SILVER	34.95	D
693246	20047	10X6	5	4.5	2-13/16	20-1/2X10	SOLID	SILVER	34.95	D
693278	20043	10X6	4	4	2-1/2	20-1/2X10	SOLID	GALVANIZED	40.95	D
693280	20048	10X6	5	4.5	2-13/16	20-1/2X10	SOLID	GALVANIZED	40.95	D
693226	20102	12X4	4	4	2-1/2	480X12/530X12	SOLID	WHITE	28.95	D
693276	20112	12X4	5	4.5	2-13/16	480X12/530X12	SOLID	WHITE	28.95	D
693286	20124	12X4	4	4	2-13/16	480X12/530X12	SPOKE	GALVANIZED	34.95	D
693288	20124	12X4	5	4.5	2-13/16	480X12/530X12	SPOKE	GALVANIZED	34.95	D
693230	20122	12X4	4	4	2-13/16	480X12/530X12	SPOKE	WHITE STRIPE	28.95	D
693232	20132	12X4	5	4.5	2-13/16	480X12/530X12	SPOKE	WHITE STRIPE	28.95	D
693290	20234	13X4.5	5	4.5	2-13/16	B78X13	SPOKE	GALVANIZED	45.95	D
693300	20232	13X4.5	5	4.5	2-5/8	B78X13	SPOKE	WHITE STRIPE	39.95	D
693292	20354	14X6	5	4.5	2-13/16	F78X14/G78X14	SPOKE	GALVANIZED	58.95	D
693301	20352	14X6	5	4.5	2-5/8	F78X14/G78X14	SPOKE	WHITE STRIPE	51.95	D
693294	20524	15X6	5	4.5	2-13/16	F78X15/H78/15	SPOKE	GALVANIZED	66.95	D
693302	20422	15X5	5	4.5	2-5/8	F78X15/H78/15	SPOKE	WHITE STRIPE	51.95	D

tires & wheels

axles, hubs & springs

tongue accessories

hitches

electrical

brake parts

trailer hardware

locks & pins

towing & loading

tie downs

tools

chemicals

TRAILER

- tires & wheels
- axles, hubs & springs
- tongue accessories
- hitches
- electrical
- brake parts
- trailer hardware
- locks & pins
- towing & loading
- tie downs
- tools
- chemicals



CARLISLE TIRE ONLY

USA trail tires are approved for over the highway use, These tires comply with the U.S. Department of transportation requirements. Their long-lasting, wrap around tread provides sure cornering and safe travel.

PART #	MFG #	TIRE SIZE	LOAD RANGE	MAX LOAD CAPACITY @ PSI	
CARLISLE TIRE ONLY					
693002	519056	480X8	B	590 @ 60	66.95 B
693004	519086	570X8	B	715 @ 50	88.95 B
693005	519087	570X8	C	910 @ 75	101.95 B
693007	519297	16.5X6.5X8	C	795 @ 70	95.95 B
693011	519472	18.5X8.5X8	C	905 @ 35	132.95 B
693018	519141	20.5X8.5X10	B	940 @ 50	134.95 B
693020	519142	20.5X8.5X10	C	1105 @ 50	166.95 B
693028	519062	480X12	B	780 @ 60	99.95 B
693030	519076	530X12	B	840 @ 55	102.95 B
693093	519161	ST175/80DX13	C	1360 @ 50	156.95 B
693095	519300	ST205/75DX14	C	1760 @ 50	163.95 B
693090	519315	ST215/75DX14	C	1820 @ 50	173.95 B
693097	519400	ST205/75DX15	C	1870 @ 50	176.95 B
CARLISLE RADIAL TIRE ONLY					
693040	5198121	ST175/80RX13	C	1360 @ 50	112.95 B
693044	5151371	ST205/75RX15	C	1820 @ 50	160.95 B



LOAD STAR TIRE ONLY

Load star provides a wide range of trailer tires designed to run cooler and longer, reduce rolling resistance and increase durability.

PART #	MFG #	TIRE SIZE	LOAD RANGE	MAX LOAD CAPACITY @ PSI	
LOAD STAR TIRE ONLY					
698002	10002	480X8	B	590 @ 60	25.95 D
698004	10010	570X8	B	715 @ 50	40.95 D
698006	10012	570X8	C	910 @ 75	43.95 D
698028	10060	480X12	B	780 @ 60	40.95 D
698030	10064	530X12	B	840 @ 55	48.95 D
698090	1ST76	ST175/80DX13	C	1360 @ 50	76.95 D
698095	1ST86	ST205/75DX14	C	1760 @ 50	96.95 D
698096	1ST90	ST215/75DX14	C	1820 @ 50	107.95 D
698097	1ST92	ST205/75DX15	C	1870 @ 50	96.95 D
698252	1HP26	215/60X8	C	940 @ 50	69.95 D
698254	1HP52	205/65X10	C	1105 @ 50	81.95 D
698256	1HP54	205/65X10	D	1270 @ 50	83.95 D

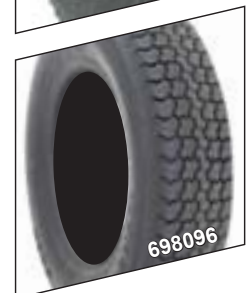
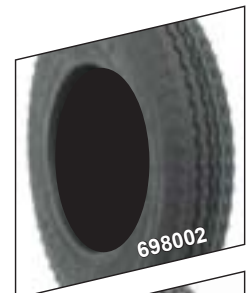

LAWN/GARDEN & TRAILER TUBES



TR13



TR87

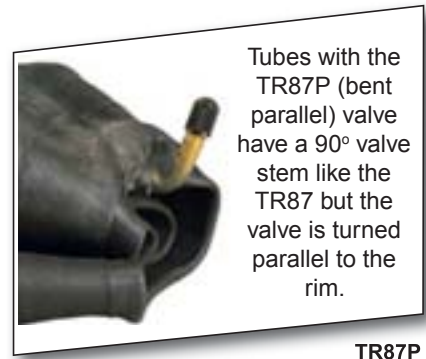

Tubes with the TR87P (bent parallel) valve have a 90° valve stem like the TR87 but the valve is turned parallel to the rim.

TR87P

PART #	MFG #	TUBE SIZE	TUBE VALVE STYLE		
Y-0430	320030	9 X 3.50-4	TR87	8.95	J
Y-0431	320031	9 X 3.50-4	TR87P	8.95	J
Y-0401	320050	280 X 2.50-4	TR87	8.95	J
Y-0406	320010	280 X 2.50-4	TR87P	8.95	J
Y-0411	320040	410 X 3.50-4	TR13	8.95	J
Y-0402	320100	410 X 3.50-4	TR87	9.95	J
Y-0403	320020	410 X 3.50-4	TR87P	8.95	J
Y-0501	320150	340 X 3.00-5	TR87	8.95	J
Y-0505	320070	410 X 350-5	TR13	9.95	J
Y-0502	320200	410 X 3.50-5	TR87	9.95	J
Y-0506	320060	410 X 3.50-5	TR87P	9.95	J
Y-0509	323980	10 X 4.50-5	TR87	10.95	J
Y-0507	11055230	11 X 4.00-5	TR13	6.95	B
Y-0504	320080	11 X 4.00-5	TR87	12.95	J
Y-0511	323520	11 X 6.00-5	TR87	11.95	J
Y-0512	323970	11 X 7.10-5	TR87	11.95	J
Y-0600	7143	145 X 70-6	TR13	9.65	G
Y-0615	11061706	145 X 70-6	TR87	10.95	B
Y-0606	904	400 X 6	TR13	7.10	J
Y-0601	320250	410 X 3.50-6	TR87	8.95	J
Y-0609	320160	410 X 3.50-6	TR13	8.95	J
Y-0604	320260	13 X 5.00-6	TR87	11.95	J
Y-0611	323790	13 X 5.00-6	TR13	11.95	J
Y-0690	320090	13 X 6.50-6	TR87	14.95	J
Y-0607	320170	13 X 6.50-6	TR13	13.95	J
Y-0670	320270	530 X 4.50-6	TR87	11.95	J
Y-0602	320290	15 X 6.00-6	TR87	12.95	J
Y-0605	323800	15 X 600 - 6	TR13	12.95	H
Y-0802	320110	300 X 8	TR13	8.95	J

PART #	MFG #	TUBE SIZE	TUBE VALVE STYLE		
Y-0801	320360	350 X 4.00-8	TR87	9.95	J
Y-0821	320120	350 X 4.00-8	TR13	8.95	J
Y-0803	320400	480 X 4.00-8	TR13	9.95	J
Y-0806	320130	480 X 4.00-8	TR87P	10.95	J
Y-0804	320450	570 X 5.00-8	TR13	11.95	J
Y-0805	320420	16 X 6.50/7.50-8	TR13	12.95	J
Y-0807	11086820	18 X 8.50/9.50 X 8	TR6	21.95	B
Y-0811	320410	18 X 6.50/8.50/9.50-8	TR13	18.95	J
Y-0809	320440	22X11.00-8	TR6	21.95	J
Y-0812	11088430	22 X 11.00-8	TR13	24.95	B
Y-0902	321500	690 X 6.00-9	TR13	18.95	J
Y-0907	11098420	22X11.00-9	TR6	23.95	B
Y-0904	321520	25X12.00-9	TR6	22.95	B
Y-0905	11099230	25X12.00-9	TR13	24.95	B
Y-1070	320770	20X8.00/10.00-10	TR13	22.95	J
Y-1018	11108020	21X7.00-10	TR6	23.95	B
Y-1017	11108320	22X8.00-10	TR6	24.95	B
Y-1016	11108420	22X11.00-10	TR6	27.95	B
Y-1101	11119020	23.5X8.00-11	TR6	26.95	B
Y-1102	11119120	24X9.00-11	TR6	24.95	B
Y-1202	320901	530 X 4.50-12	TR13	12.55	J
Y-1210	321371	22/23 X 8 R11/12	TR6	27.95	J
Y-1207	321370	23X8.50/9.50/10.50-12	TR13	22.95	J
Y-1212	321051	24/26 X 12	TR6	32.95	G
Y-1204	11084520	25X8.00-12	TR6	34.95	B
Y-1205	11109520	25X10.00-12	TR6	29.95	B
Y-1206	11129220	25/26 X 12 X 12	TR6	28.95	B
Y-1250	321050	26 X 12-12	TR13	31.95	B

TUBELESS VALVES



PART #	MFG #		HOLE SIZE	LENGTH		
690412	TR412	RUBBER STEM SNAP IN STRAIGHT	1/2"	1"	0.80	L
690413	TR412	RUBBER STEM SNAP IN STRAIGHT	1/2"	1-1/4"	0.80	L

tires & wheels

axles, hubs & springs

tongue accessories

hitches

electrical

brake parts

trailer hardware

locks & pins

towing & loading

tie downs

tools

chemicals

TRAILER

TIRES & WHEELS

FULTON HDPE PLASTIC FENDERS

Fulton plastic fenders are injection molded, Corrosion proof, impact resistant, 300lbs. capacity molded in color "scratch proof" built in fender skirt. Features mounting slots.



- tires & wheels
- axles, hubs & springs
- tongue accessories
- hitches
- electrical
- brake parts
- trailer hardware
- locks & pins
- towing & loading
- tie downs
- tools
- chemicals



- Mounting slots make installation fast and easy!
- Replace your rusted and damaged fender with a Fulton quality engineered plastic fender
- Attractive, sleek styling
- Each fender individually packaged in a poly bag with installation instructions

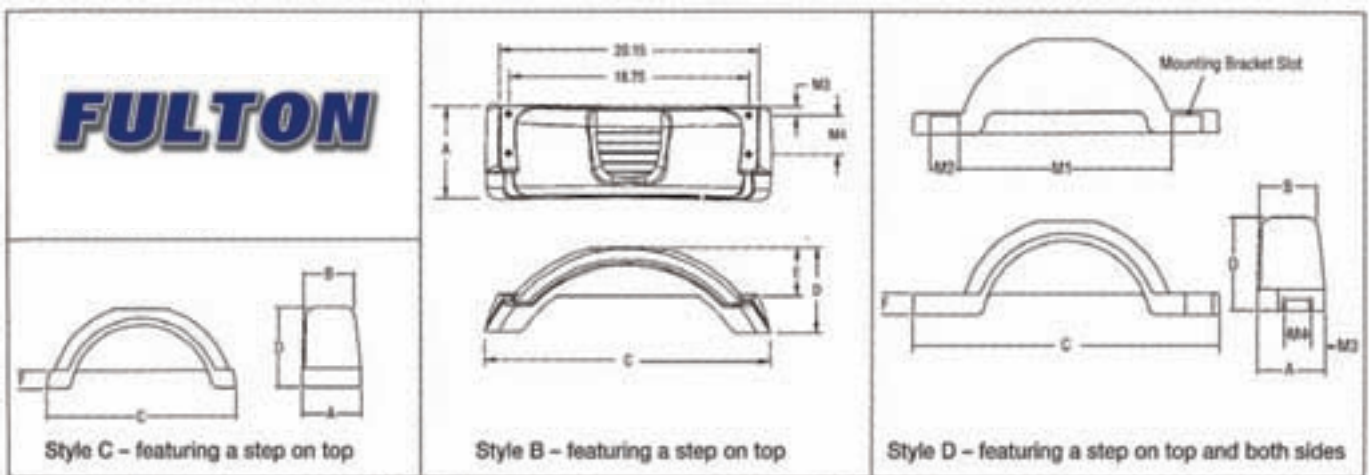

STYLE B

PART # WHITE	PART # BLACK	PART # SILVER	TIRE SIZE	A	B	C	D	E	F	M (1)	M (2)	M (3)	M (4)	UNIT WT LBS.
444357	13.87 B	444360 13.40 B	8"-12"	7.35"	-----	22.30"	6.50"	3.75"	2.18"	-----	-----	.075"	3.00"	1-1/4"

STYLE C

PART # WHITE	PART # BLACK	PART # SILVER	TIRE SIZE	A	B	C	D	E	F	M (1)	M (2)	M (3)	M (4)	UNIT WT LBS.
-----	444362 25.43 B	444365 25.95 B	13"	9.00"	7.70"	29.25"	12.00"	-----	2.75"	-----	-----	-----	-----	3
-----	-----	444366 30.95 B	14"	9.70"	8.00"	31.30"	12.75"	-----	3.00"	-----	-----	-----	-----	3-3/4

STYLE D

PART # WHITE	PART # BLACK	PART # SILVER	TIRE SIZE	A	B	C	D	E	F	M (1)	M (2)	M (3)	M (4)	UNIT WT LBS.
-----	444367 22.07 B	444368 23.29 B	12"	7.50"	6.90"	33.50"	8.75"	-----	2.50"	22.70"	4.00"	1.50"	3.00"	2-1/2
-----	444369 28.68 B	444370 30.78 B	13"	9.00"	7.70"	40.00"	12.00"	-----	2.75"	28.00"	4.00"	2.12"	3.75"	3-3/4
-----	444371 32.74 B	444372 34.43 B	14"	9.70"	8.00"	43.40"	12.75"	-----	3.00"	30.00"	4.00"	2.12"	3.75"	4-3/4

TRAILER

TIE DOWN ENGINEERING PLASTIC FENDERS

Upgrade your trailer with these high impact polyethylene fenders. Plastic fenders are UV protected. Designed for normal and low profile tire. Small fenders have "no load" capacity and fits 8" to 12" wheels. Large fenders have a 200 lbs. capacity and fit 13"-15" wheels.



PART #	MFG #	DESCRIPTION	DIMENSIONAL SIZE	TIRE SIZE	COLOR	PROFILE	UM		
LR17026	17026	PLASTIC FENDER	7-3/4"W X 21"L X 5"H	8" - 12"	WHITE	LOW	EA	14.66	G
LR17033	17033	PLASTIC FENDER	7-3/4"W X 21"L X 5"H	8" - 12"	BLACK	LOW	EA	14.76	G
276001	44332	PLASTIC FENDER	11-3/8"W x 45"L x 11"H	14"	WHITE	STEP	EA	48.03	G
276002	44331	PLASTIC FENDER	11-3/8"W x 45"L x 11"H	14"	BLACK	STEP	EA	48.03	G

TIE DOWN ENGINEERING BRACKETS

Fender brackets come packaged as a pair 2 required for each fender.

PART #	MFG #	DESCRIPTION	WHEEL SIZE	COLOR	PROFILE	UM		
LR81231	81231	BRACKET FOR 8"-12"	8" to 12"	GALVANIZED	LOW	PR	16.67	G
276000	44141	BRACKET FOR LARGE FENDERS	LARGE	GALVANIZED	STEP	EA	11.49	G



SMITH METAL FENDERS

Heavy-duty 16 gauge steel.

- Fenders can be drilled to fit a variety of mounting options
- Fenders are paintable
- Mounting brackets not included



JEEP STYLE FENDERS

PART #	MFG #	DESCRIPTION	DIMENSIONAL SIZE	TIRE SIZE	COLOR	UM		
CS18000	18000	METAL FENDER	8-1/2"W X 23-3/4"L X 7-1/2"H	8"	METAL	EA	27.75	G

ROUND 16 GAUGE GALVANIZED STEEL FENDER

PART #	MFG #	DESCRIPTION	DIMENSIONAL SIZE	TIRE SIZE	COLOR	UM		
FND08	17700G	METAL FENDER	7"W X 20"L X 6"H	8"	GALVANIZED	EA	19.80	G
FND12	17701G	METAL FENDER	7"W X 23-1/2"L X 6-3/4"H	12"	GALVANIZED	EA	20.75	G
FND13	17800G	METAL FENDER	8"W X 27-3/4"L X 11"H	13"	GALVANIZED	EA	30.00	G
FND14	17900G	METAL FENDER	9"W X 31-1/2"L X 13-1/4"H	14"-15"	GALVANIZED	EA	38.45	G

SMITH FENDER BRACKETS

- Galvanized brackets built for smith metal fenders
- Use two brackets per a fender. (No hardware included).

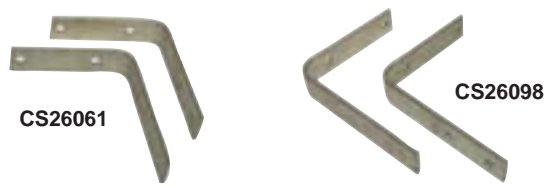

PART #	MFG #	DESCRIPTION	WHEEL SIZE	COLOR	PROFILE	UM		
CS26061	26061GA	BRACKET FOR 7" WIDE FENDER	8" - 12"	GALVANIZED	L SHAPE	EA	22.95	H
CS26098	26098GA	BRACKET FOR 8"-9" WIDE FENDER	13" - 15"	GALVANIZED	L SHAPE	EA	22.95	H

- tires & wheels
- axles, hubs & springs
- tongue accessories
- hitches
- electrical
- brake parts
- trailer hardware
- locks & pins
- towing & loading
- tie downs
- tools
- chemicals

TRAILER

- tires & wheels
- axles, hubs & springs
- tongue accessories
- hitches
- electrical
- brake parts
- trailer hardware
- locks & pins
- towing & loading
- tie downs
- tools
- chemicals

TRAILER

FULTON HIGH MOUNT SPARE TIRE CARRIER

Fits most 4, 5 and 6 lug wheels up to 16-1/2". Provides 4-3/4" lift and over 7" of offset to mount tire up and out of the way zinc-plated to resist corrosion. Easy bolt on no cutting or drilling. Fits trailer tongue up to 3" wide and 5" high. All hardware included.

PART #	MFG #	DESCRIPTION	UM		
928052	HDSTC0101	SPARE TIRE CARRIER	EA	52.92	G

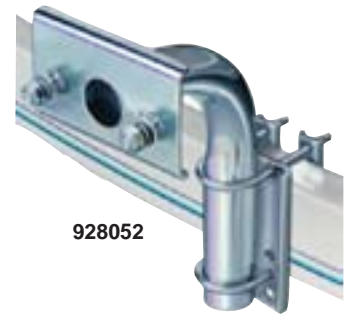

928052

FULTON HIGH MOUNT SPARE TIRE CARRIER

Heavy duty, welded and reinforced steel plate construction zinc-plated to resist corrosion. Adjustable bolt circle to fit 4 and 5 lug wheels. Fits all trailer tongues 3" wide and 4" high includes zinc-plated hardware. Features a security locking hole to lock wheel in place.

PART #	MFG #	DESCRIPTION	UM		
FT122	STC1000101	HI-MOUNT SPARE TIRE CARRIER	EA	36.96	E

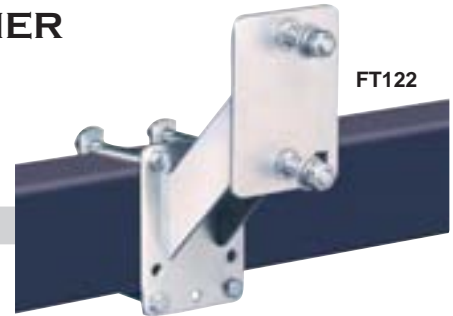

FT122

FULTON SPARE TIRE CARRIER

Fits 8" - 15" wheels with 4 or 5 lug rims. Includes lug nuts to secure wheel to frame. Heavy-duty 1/2" diameter construction. Zinc-plated to resist rust

PART #	MFG #	DESCRIPTION	UM		
FT120	ETC0101	ECONOMY SPARE TIRE CARRIER	EA	10.65	E
FT119	ETCHL0700	ECONOMY SPARE TIRE CARRIER W/LOCKING LEVERS	EA	27.01	E

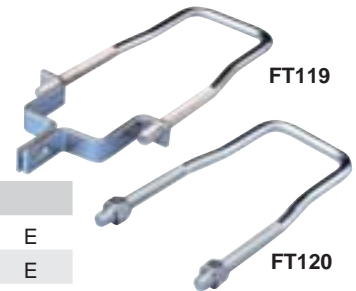

FT119

FT120

SMITH HEAVY DUTY SPARE TIRE CARRIER

Strong 7 gauge steel construction. Hooks securely on frame or tongue. Holds 4 or 5 lug wheels and adjusts for frames 3" wide and 4" highside offset is 4-1/2" from frame with a 5" rise. For more ground clearance. All mounting hardware is included.

PART #	MFG #	DESCRIPTION	UM		
CS27310	27310G	HEAVY-DUTY SPARE TIRE CARRIER	EA	36.95	G



CS27310

SMITH HEAVY DUTY SPARE TIRE CARRIER

Heavy 7/16" u-bolt secures tire on tongue or frame up to 3" wide holds 4 or five lug will fit 8"-14" and most 15" wheels adjustable threaded brackets will hold padlock for security. Thread length 3" u-bolt is 8-3/8" long zinc plated

PART #	MFG #	DESCRIPTION	UM		
CS27200	27200	WITH LUG NUTS	EA	10.35	G
CS27201	27201	WITH LOCKING BRACKETS	EA	14.20	G
CS27202	27202	WITH BRACKETS AND KEYED PADLOCK	EA	24.95	G



CS27201

CS27202

CS27200

SPARE TIRE COVERS

- Weather and UV Protection
- Strong black vinyl with corded edge and elastic closure for snug fit
- Protects tires from sun and foul weather
- Display packaged



PART #	MFG #	TIRE SIZE	DIAMETER	DEPTH	UM		
CS27410	27410	12"	21"	6-1/2"	EA	16.75	G
CS27420	27420	13"	25"	7-1/2"	EA	21.95	G
CS27430	27430	14"	27"	8-1/2"	EA	22.20	G
CS27440	27440	15"	29"	9-1/2"	EA	22.65	G

ULTRA-MAX WHEEL LOCKS

TX0100	TWL100	TRIMAX ULTRA-MAX WHEEL LOCK	EA	259.95	B
TX0175	TCL75	TRIMAX WHEEL CHOCK LOCK	EA	94.95	E



TX0175



TX0100

WHEEL CHOCKS

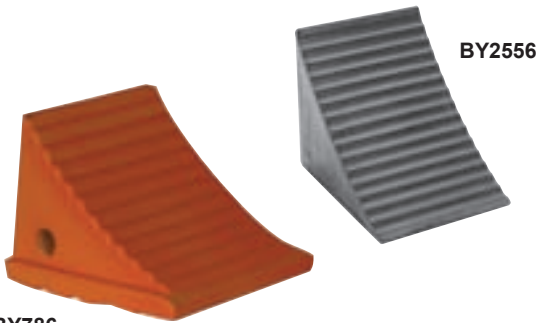

BY786

BY2556



BY1467



444355

BY2556	WC2556A	HEAVY DUTY RUBBER WHEEL CHOCK	EA	39.95	G
BY786	WC786	POLYURETHANE WHEEL CHOCK	EA	29.95	G
BY1467	WC1467A	RUBBER WHEEL CHOCK	EA	12.95	G
FT090	TK1000100	FULTON GORILLA GUARD	EA	104.41	E
444355	7000100	TIRE CHOCKS (ORDER IN 6 PAIR MULTIPLE ONLY)	SET	12.33	B



SOLO HITCH ALIGNMENT SYSTEM

- Convenient one person hitch alignment system
- Magnetic base for fast and easy location
- Telescoping rods adjust up to 42"
- Easy to use the first time

PART #	MFG #	DESCRIPTION	UM		
444356	63300	SOLO HITCH ALIGNMENT SYSTEM	EA	28.43	B



tires & wheels

axles, hubs & springs

tongue accessories

hitches

electrical

brake parts

trailer hardware

locks & pins

towing & loading

tie downs

tools

chemicals

TRAILER

tires & wheels

axles, hubs & springs

tongue accessories

hitches

electrical

brake parts

trailer hardware

locks & pins

towing & loading

tie downs

tools

chemicals

TRAILER

MINI DIAL TIRE PRESSURE GAUGE

- 1 to 60 PSI range
- Measures 1 one pound increments
- 1" easy to read white face dial
- Proper tire maintenance saves money by improving fuel economy and reducing tire wear
- Ideal for cars, trucks, SUV's, bicycles and more



P Performance Tool
260069 4.95 G

DIGITAL TIRE PRESSURE GAUGE

- Backlit display and convenient lighted tip.
- Triple function display P.S.I., BAR, and KPa.
- Auto off feature: Automatically shuts off in 30 seconds when not in use



P Performance Tool
260070 13.95 G

12V COMPACT TIRE INFLATOR

- Plugs into 12-Volt Accessory Outlet
- Includes Two Nozzle Adapters and Sport Needle
- Great for Tires, Toys and Sporting Goods
- 10 Ft. Power Cord
- 18 in. Hose Length with Universal Valve Adapter
- Handy on/off switch
- Easy to read pressure gauge
- High output 250 PSI motor



P Performance Tool
260006 18.95 G

MINI TIRE INFLATOR

- 100 PSI high pressure air compressor inflates standard car tire in under 8 minutes.
- Compact size for easy storage with convenient storage compartment.
- 9' power cord with fused 12V power plug.
- 12V power cord plugs into vehicle power outlet.
- Built in dial pressure gauge.
- Accessories include sports ball needle, raft and toy inflator nozzles and Presta valve adapter.
- 17.5" high pressure hose.



P Performance Tool
260007 23.95 G

TIRE INFLATOR W/LED

- 100 PSI high pressure air compressor.
- Large easy to read built in dial pressure gauge.
- 3 Super bright LEDs for night time emergencies.
- 15" high pressure hose with screw on chuck.
- 10' power cord with fused 12V power plug.
- 12V power cord plugs into vehicle power outlet.
- Inflates standard car tire in under 4 minutes (Performance based upon 175/70 R13 tire to 30 PSI).
- Accessories include sports ball needle, raft and toy inflator nozzles and Presta valve adapter.



P Performance Tool
260008 32.95 G

4 WAY FOLDING LUG WRENCH

- SAE heavy duty drop forged steel
- Chrome plated to resist corrosion
- SAE and metric sizes: 11/16", 3/4", 13/16" and 7/8", 17mm, 19mm, 21mm and 23mm
- Folds down for compact storage



P Performance Tool
260089 17.95 G

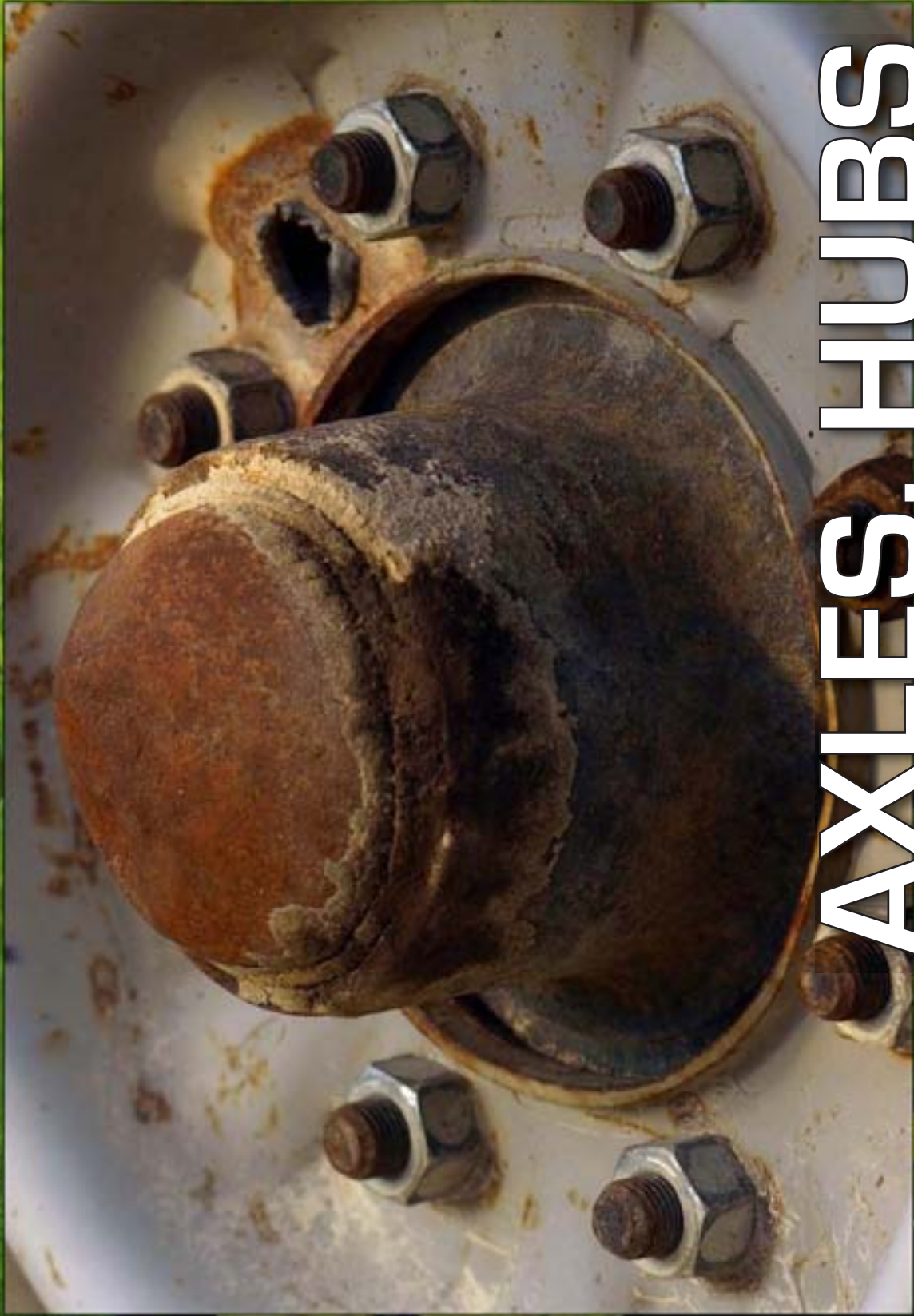

AXLES, HUBS & SPRINGS



AXLES, HUBS & SPRINGS

- tires & wheels
- axles, hubs & springs
- tongue accessories
- hitches
- electrical
- brake parts
- trailer hardware
- locks & pins
- towing & loading
- tie downs
- tools
- chemicals



RELIABLE TRAILER AXLES

All axles come with axle nut and cotter pin attached and include spring seats (loose) that can be mounted over or under.

NOTE: ALL AXLES MUST BE INSTALLED WITH CENTER BOW UP. THE CENTER BOW EXISTS UNTIL WEIGHT IS PUT ON THE AXLE.

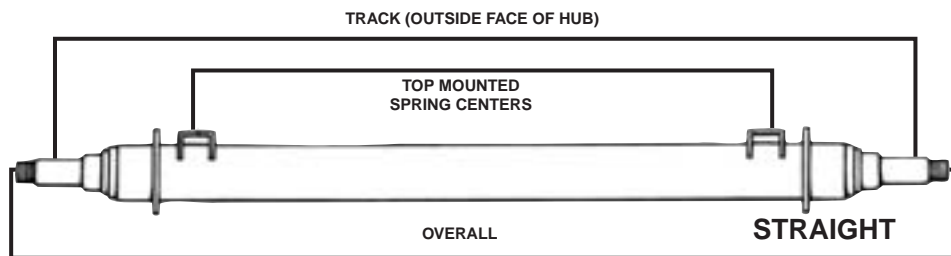

2000# ROUND TUBE AXLES UNFLANGED "L" SERIES

PART #	MFG #		TRACK WIDTH	SPRING CENTER FLANGE	OVERALL LENGTH	AXLE SIZE	HUB USED	SPINDLE SIZE	BRAKE SIZE ELECTRIC/ HYDRAULIC
230052	SP-2000-48"	83.95	E 48"	30" - 38-1/2"	52-1/2"	1-3/4"	230060, 230061	1-1/16" straight	7" X 1-1/4" ELECTRIC 7" X 1-3/4" HYDRAULIC
230053	SP-2000-54"	96.95	E 54"	36" - 44-1/2"	58"	1-3/4"	230060, 230061	1-1/16" straight	7" X 1-1/4" ELECTRIC 7" X 1-3/4" HYDRAULIC
230054	SP-2000-012	96.95	E 60"	42" - 50-1/2"	64-1/2"	1-3/4"	230060, 230061	1-1/16" straight	7" X 1-1/4" ELECTRIC 7" X 1-3/4" HYDRAULIC
230055	SP-2000-64"	103.95	E 64"	46" - 54-1/2"	68-1/2"	1-3/4"	230060, 230061	1-1/16" straight	7" X 1-1/4" ELECTRIC 7" X 1-3/4" HYDRAULIC
230056	SP-2000-72"	104.95	E 72"	54" - 62-1/2"	76-1/2"	1-3/4"	230060, 230061	1-1/16" straight	7" X 1-1/4" ELECTRIC 7" X 1-3/4" HYDRAULIC
230057	SP-2000-84"	114.95	E 84"	66" - 74-1/2"	88-1/2"	1-3/4"	230060, 230061	1-1/16" straight	7" X 1-1/4" ELECTRIC 7" X 1-3/4" HYDRAULIC

3500# ROUND TUBE AXLES BRAKE FLANGED "H" SERIES

PART #	MFG #		TRACK WIDTH	SPRING CENTER FLANGE	OVERALL LENGTH	AXLE SIZE	HUB USED	SPINDLE SIZE	BRAKE SIZE ELECTRIC/ HYDRAULIC
RL3560	SP-3500-60"	126.60	G 60"	42" - 48"	65"	2-3/8"	HSH545	1-3/8" - 1-1/16" stepped	10" X 2-1/4" ELECTRIC 10" X 2-1/4" HYDRAULIC
RL3572	SP-3500-72"	136.95	E 72"	54" - 60"	77"	2-3/8"	HSH545	1-3/8" - 1-1/16" stepped	10" X 2-1/4" ELECTRIC 10" X 2-1/4" HYDRAULIC
RL3584	SP-3500-84"	146.95	G 84"	66" - 72"	89"	2-3/8"	HSH545	1-3/8" - 1-1/16" stepped	10" X 2-1/4" ELECTRIC 10" X 2-1/4" HYDRAULIC
RL3588	SP-3500-88"	153.95	E 88"	70" - 76"	93"	2-3/8"	HSH545	1-3/8" - 1-1/16" stepped	10" X 2-1/4" ELECTRIC 10" X 2-1/4" HYDRAULIC
RL3588D	SP-3500-88"D	220.55	E 88"	70" - 74"	93"	2-3/8"	HSH545	1-3/8" - 1-1/16" stepped	10" X 2-1/4" ELECTRIC 10" X 2-1/4" HYDRAULIC

7000# ROUND TUBE AXLES BRAKE FLANGED

PART #	MFG #		TRACK WIDTH	SPRING CENTER FLANGE	OVERALL LENGTH	AXLE SIZE	HUB USED	SPINDLE SIZE	BRAKE SIZE ELECTRIC/ HYDRAULIC
RL7086	SP-7000-86"	233.05	H 88"	70" - 74"	92"	3"	N/A	1-3/4" - 1-1/4" STEPPED	12" X 2" ELECTRIC 12" X 2" HYDRAULIC
RL7090	SP-7000-90"	238.20	H 92"	74" - 76"	96"	3"	N/A	1-3/4" - 1-1/4" STEPPED	12" X 2" ELECTRIC 12" X 2" HYDRAULIC

RUBBER TORSION AXLES

- 3 sizes
- All beams are E-coated
- Rubber cushioned inside steel bar absorbs road shock and provides torque action that improves load handling and reduces shock transfer and trailer swaying
- All axles come cambered with one piece forged spindle and arm



PART #	MFG#		WEIGHT	TRACK WIDTH	OUTSIDE BRACKETS	AXLE SIZE	HUB USED	SPINDLE SIZE
RL3600	RT2000-237	329.95	G 2000#	62"	48"	N/A	HSH545	N/A
RL3602	RT2000-236	369.95	G 2000#	73-1/2"	60"	N/A	N/A	N/A
RL3604	RT2700-064	355.05	G 2700#	86"	72"	N/A	HSH46,56	1" STRAIGHT

TRAILER

FLEXIRIDE SUSPENSION UNIT

- Flexiride allows independent suspension for each wheel
- Each piece is completely independent of one another
- Will fit any width trailer. Weld base plate to cross member, check to be square with frame (very important)
- Bolt flexiride arm to base plate with arm trailing to rear of trailer
- 3 sizes available
- Sold in pairs
- Base plates extra - sold each (order 2 for pair)
- Note: Spindle nut, washer, and cotter pin must be ordered separately

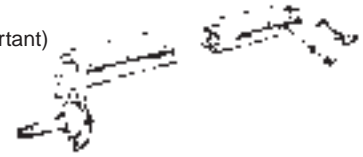

PART #	MFG #	WEIGHT		SPINDLE SIZE	HUB USED	SPINDLE BEARING	SPINDLE NUT	SPINDLE WASHER	SPINDLE COTTER PIN	
FR935	FR-935	249.20	B	935#	1" STRAIGHT	N/A	LM44643	ANT1	SWP1	CP2
FR1400	FR1400B	285.40	B	1400#	1-1/16" STRAIGHT	N/A	LM44649	ANT1	SWP1	CP2
FR2000*	FR-2000	348.95	H	2000#	1-1/16" STRAIGHT	N/A	LM44649	ANT1	SWP3	CP2

*HAS A GREASABLE SPINDLE, NEEDS LOCK WASHER PART #230058

SPRING SEAT

PART #	MFG #	AXLE WIDTH	SPRING WIDTH
690996	SS100	2.55 H	1-3/4" 1-3/4"

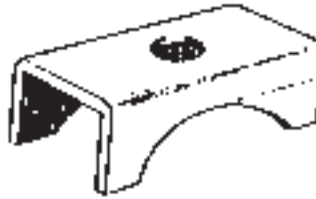

SPINDLE WASHERS

PART #	MFG #	STYLE	SIZE	U/M
SWP34	SW-750	1.60 N	A 3/4"	EA
SWP1	11070	0.62 E	A 1"	EA
SWP3	SW3	0.90 L	B 1-3/16"	EA
SWP2	SW-2	1.25 L	C TONGUE	EA
230058	FS12-12	0.95 G	C TONGUE	EA

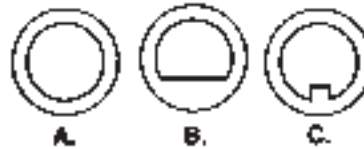

SPINDLE NUTS

PART #	MFG #	STYLE	SIZE	U/M
ANT1	11065	2.18 L	SLOTTED 1"	EA



SPINDLE COTTER PIN

PART #	MFG #	A	B	U/M
CP2	11075Z	0.17 G	2" 1/8"	EA
CP103	SCP103	0.30 H	1-15/16" 3/8"	EA

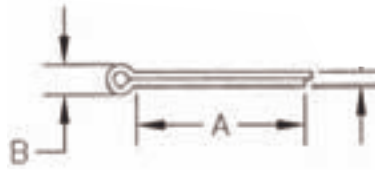

SPINDLE NUT LOCK SHIELD

PART #	MFG #	A	B	U/M
75-813	LS813	1.55 G	.845" 1.140"	EA

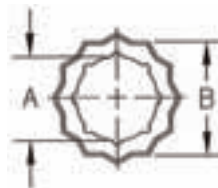

SPINDLE NUT KITS

PART #	MFG #	NUT	WASHER	COTTER PIN	U/M
230010	230010	2.40 L	ANT1 SWP1	CP2	EA
230011	230011	2.70 L	ANT1 SWP3	CP2	EA



tires & wheels

axles, hubs & springs

tongue accessories

hitches

electrical

brake parts

trailer hardware

locks & pins

towing & loading

tie downs

tools

chemicals

TRAILER

AXLES, HUBS & SPRINGS

RELIABLE COMPLETE HUB KITS

- Hub assemblies include nuts, bolts, 2 bearings, 2 cups, 1 grease seal, and 1 dust cap
- Hubs only are sold with only the cups installed



4 HOLE HUBS

PART #		BEARING SIZE	INNER	BEARING SIZE	OUTER	HUB LENGTH	DISTANCE BET. RACES	HUB CAPACITY	HUB ONLY		
HSH4	29.95	G	1"	LM44643	1"	LM44643	4-1/8"	2-7/16"	1000#	230017 23.70	G
HSH46	29.95	G	1-1/16"	LM44649	1-1/16"	LM44649	4-1/8"	2-7/16"	1150#	230017 23.70	G
230060	32.95	H	1-1/16"	LM44649	1-1/16"	LM44649	4-1/8"	2-7/16"	-----	230017 23.70	G

5 HOLE HUBS

PART #		BEARING SIZE	INNER	BEARING SIZE	OUTER	HUB LENGTH	DISTANCE BET. RACES	HUB CAPACITY	HUB ONLY		
HSH5	31.95	G	1"	LM44643	1"	LM44643	4-1/8"	2-7/16"	1000#	230018 20.95	G
HSH525	32.95	G	1"	LM44643	1"	LM44643	3-1/2"	1-11/16"	700#	230020 25.85	G
HSH56	36.95	G	1-1/16"	LM44649	1-1/16"	LM44649	4-1/8"	2-7/16"	1150#	230018 20.95	G
HSH545	38.95	G	1-3/8"	LM68149	1-1/16"	LM44649	4-1/4"	2-1/8"	1750#	230019 30.80	G
HSH812	109.95	G	1-1/4"	LM67048	1-1/4"	LM67048	4-3/16"	2-3/16"	1250#	-----	
230061	32.95	H	1-1/16"	LM44649	1-1/16"	LM44649	4-1/8"	2-7/16"	-----	230018 20.95	G

SHIPSHAPE COMPLETE HUB KITS

- Includes: hub, bearings, seal, lug nuts, dust cap, grease
- Painted, cast iron replacement hubs for all types of trailers
- All hubs are studded (as shown)



4 HOLE HUBS

PART #	MFG #		BEARING SIZE	INNER	BEARING SIZE	OUTER	HUB LENGTH	DISTANCE BET. RACES	HUB CAPACITY	HUB
CS13110	13100	54.95	G	1"	L44643	1"	L44643	4-1/8"	2-7/16"	1250# N/A
CS13109	13109	56.95	G	1-1/16"	L44649	1-1/16"	L44649	4-1/8"	2-7/16"	1350# N/A

5 HOLE HUBS

PART #	MFG #		BEARING SIZE	INNER	BEARING SIZE	OUTER	HUB LENGTH	DISTANCE BET. RACES	HUB CAPACITY	HUB
CS13210	13210	59.95	G	1"	L44643	1"	L44643	4-1/8"	2-7/16"	1250# N/A

TURBO LUBE COMPLETE HUB KITS

- Turbo Lube oil bath lubricating system rotates individual roller bearings over four times through oil for each wheel revolution keeping your hub and bearings cooler, reducing wear and friction, and actually increasing tow vehicle mileage
- The unique see through threaded oil cap assures a leak proof seal and lets you know if your bearings have adequate lubrication for the next long haul
- 75-90 weight gear oil recommended (not included)



4 HOLE HUBS

PART #	MFG #		BEARING SIZE	INNER	BEARING SIZE	OUTER	HUB LENGTH	DISTANCE BET. RACES	HUB CAPACITY	HUB
LR81038*	N/A	39.50	B	1"	LM44643	1"	LM44643	4-1/8"	2-7/16"	1350# N/A

* FITS ALL WHEELS WITH A CENTER HOLE OF 2.90" OR LARGER, MAY NOT FIT ON ALL 8"-13" WHEELS

REPLACEMENT OIL CAP & SEAL ONLY

PART #	MFG #		
LR48394A	48399A	10.26	G

TRAILER

- tires & wheels
- axles, hubs & springs
- tongue accessories
- hitches
- electrical
- brake parts
- trailer hardware
- locks & pins
- towing & loading
- tie downs
- tools
- chemicals

WHEEL BOLTS

PART #	MFG #		A	B	C	THREAD	STYLE	U/M	
			LENGTH	LENGTH	DIAMETER				
75-5024	ST-502-04	1.50	G	1.813"	.438"	.543"	1/2"-20	PRESS IN	EA
75-500	ST-500	1.65	G	2"	1.063"	.688"	1/2"-20	SCREW IN	EA
WBP5	WBP-5	1.00	L	1-3/4"	1/4"	1/2"	1/2"-20	PRESS IN	EA
WBP3	WBP-3	1.00	L	7/8"	1/4"		3/8"-24	PRESS IN	EA

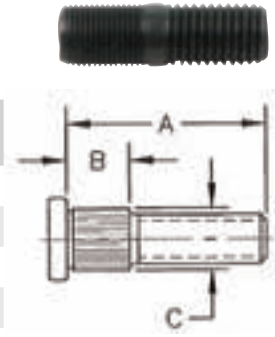

WHEEL BOLTS, NUTS, AND KITS

PART #	MFG #		THREAD	DESCRIPTION	U/M
WBT12	11060	1.03	J 1/2"-20	WHEEL BOLT	EA
LNT12	11051	0.25	H 1/2"-20	LUG NUT	EA
LNT76	LN76	0.50	L 7/16"-20	LUG NUT	EA
230012	230012	5.25	L 1/2"-20	WHEEL BOLT	PKG 5
230013	230013	1.95	L 1/2"-20	LUG NUT	PKG 5
230014	230014	3.25	L 7/16"-20	LUG NUT	PKG 5



tires & wheels

axles, hubs & springs

tongue accessories

hitches

electrical

brake parts

trailer hardware

locks & pins

towing & loading

tie downs

tools

chemicals

TRAILER

AXLES, HUBS & SPRINGS

- tires & wheels
- axles, hubs & springs
- tongue accessories
- hitches
- electrical
- brake parts
- trailer hardware
- locks & pins
- towing & loading
- tie downs
- tools
- chemicals

TIE DOWN ENGINEERING SPINDLES



- Spindle is turned from high-tensile, cold-rolled steel on automotive-quality CNC lathes
- Spindle must be properly welded to axle tube
- 1" spindle end
- Includes castle nut, washer and cotter pin
- Sold individually



PART #	MFG #	CAPACITY	END SIZE	LENGTH	STUB LENGTH	HUB LENGTH	INNER BEARING	SIZE	OUTER BEARING	SIZE	STUB STYLE		
LR80055	80055	20.60	G	1250#	1-1/4"	8-1/2"	2-5/8"	3-7/16"	LM44643	1"	LM44643	1"	ROUND
LR80060	80060	20.60	G	1350#	1-1/4"	7"	2"	3-7/16"	LM44649	1-1/16"	LM44649	1-1/16"	ROUND
LR80235	80235	24.63	G	1750#	1-3/4"	8"	2-9/16"	3-1/4"	LM68149	1-3/8"	LM44649	1-1/16"	ROUND

RELIABLE SPINDLES



- Cotter pin, washer, and castle nut sold separately
- Sold each (bulk)

PART #	MFG #	CAPACITY	END SIZE
RL1250	S-1250	16.95	E
RL1350	S-1350	13.55	E

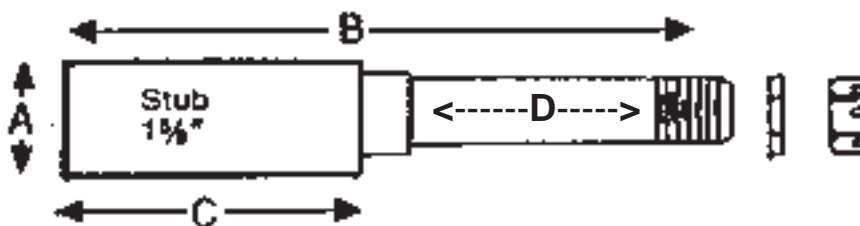

CAPACITY PER PAIR	END SIZE	LENGTH	STUB LENGTH	HUB LENGTH	INNER BEARING	SIZE	OUTER BEARING	SIZE	STUB STYLE	COTTER PIN	WASHER	CASTLE NUT
2500#	1-1/4"	8-1/2"	3-1/8"	3-3/8"	LM44643	1"	LM44643	1"	ROUND	CP2	SWP1	ANT1
2700#	1-1/4"	8-1/2"	3-1/8"	3-3/8"	LM44649	1-1/16"	LM44649	1-1/16"	ROUND	CP2	SWP1	ANT1

Sold in display packages with castle nut, washer, and cotter pin included.

PART #	MFG #	CAPACITY PER PAIR	END SIZE	LENGTH	STUB LENGTH	HUB LENGTH	INNER BEARING	SIZE	OUTER BEARING	SIZE	STUB STYLE		
RL2000	2000	27.95	G	2500#	1-1/4"	8-1/2"	3-3/4"	3-3/8"	LM44643	1"	LM44643	1"	ROUND
RL2001	2001	27.95	G	2700#	1-1/4"	8-1/2"	3-3/4"	3-3/8"	LM44649	1-1/16"	LM44649	1-1/16"	ROUND

TRAILER

LEAF SPRINGS

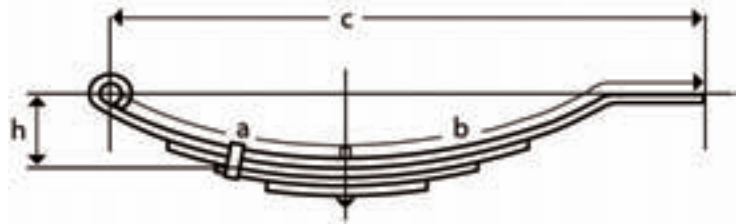

SLIPPER STYLE - FLAT END

PART #	MFG #	PER SPRING CAPACITY	# OF LEAVES	UNLOADED LENGTH	CENTER EYE TO SPRING BOLT (A)	SPRING BOLT TO SPRING END (B)	FREE OPEN (H)	SPRING WIDTH	BUSHING INCLUDED?		
25" LONG											
SLS0925	UNA203	900#	3	25"	12.10"	14.50"	3.50"	1-3/4"	YES	27.00	G
SLS1225	UNA207	2300#	5	25"	12.10"	14.50"	3.50"	1-3/4"	YES	51.05	E
30" LONG											
SLS0830	UNA-038*(F)	880#	2	30"	15"	17.75"	4.88"	1-3/4"	USE LSB2	35.45	E
SLS1430	UNA-039*(F)	1430#	3	30"	15"	17.75"	4.88"	1-3/4"	USE LSB2	42.80	E
SLS1830	UNA-040*(F)	1830#	4	30"	15"	17.75"	4.88"	1-3/4"	USE LSB2	55.65	E
SLS2330	UNA-040N (F)	2290#	5	30"	15"	17.75"	4.88"	1-3/4"	USE LSB2	74.00	G

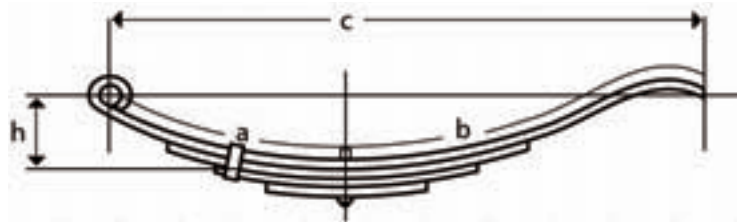

SLIPPER STYLE - RADIUS END

PART #	MFG #	PER SPRING CAPACITY	# OF LEAVES	UNLOADED LENGTH	CENTER EYE TO SPRING BOLT (A)	SPRING BOLT TO SPRING END (B)	FREE OPEN (H)	SPRING WIDTH	BUSHING INCLUDED?		
25" LONG											
SLS7025	UNA-178 (R)	750#	3	25"	12"	14.50"	4"	1-3/4"	YES	21.25	E
SLS9025	UNA-179 (R)	900#	4	25"	12"	14.50"	4"	1-3/4"	YES	27.95	E
SLS1125	UNA-180 (R)	1240#	5	25"	12"	14.50"	4"	1-3/4"	YES	35.85	E
SLS1027	UNA-132	1000#	2	27.50"	13.62"	16.50"	4.63"	1-3/4"	YES	36.20	E

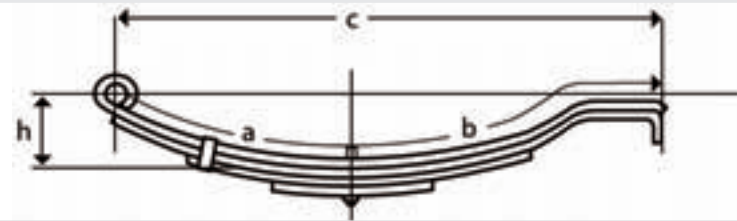

SLIPPER STYLE - HOOK DOWN

PART #	MFG #	PER SPRING CAPACITY	# OF LEAVES	UNLOADED LENGTH	CENTER EYE TO SPRING BOLT (A)	SPRING BOLT TO SPRING END (B)	FREE OPEN (H)	SPRING WIDTH	BUSHING INCLUDED?		
25" LONG											
SLS2530	UNA-231 (HD)	2500#	4	26.48"	11.96"	15.90"	3.06"	2"	YES	59.30	E
30" LONG											
SLS0730	UNA-195 (HD)	750#	3	30"	14.60"	18.75"	4.13"	1-3/4"	YES	36.20	E
SLS1030	UNA-196 (HD)	1000#	4	30"	14.75"	18.90"	4.31"	1-3/4"	YES	42.40	E
SLS1530	UNA-197	1250#	5	30"	14.75"	18.50"	4.31"	1-3/4"	YES	50.10	E

- tires & wheels
- axles, hubs & springs
- tongue accessories
- hitches
- electrical
- brake parts
- trailer hardware
- locks & pins
- towing & loading
- tie downs
- tools
- chemicals

TRAILER

AXLES, HUBS & SPRINGS

LEAF SPRINGS CONTINUED

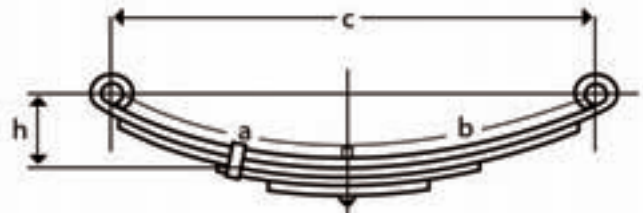

DOUBLE EYE SPRING

PART #	MFG #	PER SPRING CAPACITY	# OF LEAVES	UNLOADED LENGTH	CENTER EYE TO SPRING BOLT (A)	SPRING BOLT TO SPRING END (B)	FREE OPEN (H)	SPRING WIDTH	BUSHING INCLUDED?		
20" LONG											
DES7020	UNA-168	700#	3	20.31"	11"	11"	3.38"	1-3/4"	YES	20.40	H
DES1020	UNA-169	1000#	3	20.38"	11"	11"	3.19"	1-3/4"	YES	20.95	G
25" LONG											
DES1225	UNA-219	1250#	3	25.13"	13.29"	13.29"	3.18"	1-3/4"	YES	26.55	E
DES1525	UNA-212	1830#	4	25.13"	13.19"	13.19"	3.25"	1-3/4"	YES	34.10	E
DES2025	UNA-220	2000#	3	25.25"	13.25"	13.25"	3"	1-3/4"	YES	32.00	E
DES3025	UNA-221	3000#	4	25.13"	13.29"	13.29"	3.29"	1-3/4"	YES	40.30	E
26" LONG											
DES1026	UNA-124	1000#	4	26"	14.07"	14.07"	4"	1-3/4"	YES	32.35	E
DES2526	UNA-052	2500#	5	26"	14"	14"	4.25"	1-3/4"	YES	53.60	E
27" LONG											
DES1027	UNA-141	1000#	3	27"	13.98"	13.98"	2.83"	1-3/4"	YES	35.25	H
DES1727	UNA-210	1750#	4	27"	13.98"	13.98"	2.75"	1-3/4"	YES	47.65	E
DES3027	UNA142	3000#	6	27"	14.14"	14.14"	3.25"	1-3/4"	YES	76.45	E
29.70" LONG											
DES0630	UNA-035	650#	3	29.70"	15.63"	15.63"	4"	1-3/4"	USE LSB2	33.45	E
DES1130	UNA-036	1250#	5	29.70"	15.63"	15.63"	4"	1-3/4"	USE LSB2	53.50	D
DES1530	UNA-032	1500#	7	29.70"	15.63"	15.63"	4"	1-3/4"	USE LSB2	67.95	E
29.75" LONG											
DES1230	UNA-224	1250#	3	29.75"	15.87"	15.87"	4.38"	1-3/4"	YES	45.20	E

- tires & wheels
- axles, hubs & springs
- tongue accessories
- hitches
- electrical
- brake parts
- trailer hardware
- locks & pins
- towing & loading
- tie downs
- tools
- chemicals

TRAILER

PLASTIC SPRING BUSHINGS

PART #	MFG #	OUTSIDE DIAMETER	INSIDE DIAMETER	LENGTH	STYLE	U/M		
LSB1	PE 227	11/16"	9/16"	1-3/4"	2	EA	0.80	J
LSB2	PE 225	7/8"	9/16"	1-3/4"	2	EA	1.15	J
LSB4	PE226	11/16"	1/2"	1-3/4"	2	EA	0.80	J
LSB5	PE224	7/8"	1/2"	1-3/4"	2	EA	1.15	J
LSB182	PE182	7/8"	1/2"	11/16"	1	EA	1.15	J

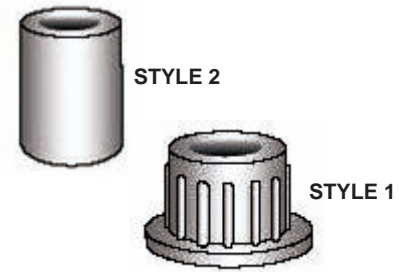

EQUALIZERS

- Sold each
- With nylon bushing

PART #	MFG #	LENGTH (L)	HEIGHT (H)	BUSHING ID (D)	BUSHING PART #		
690990	13-10	6.06"	4"	9/16" (3)	LSB1	10.40	G
690991	13-104	5.70"	2.03"	9/16" (3)	LSB1	6.70	H
690992	E-1	7.75"	2.88"	9/16" (3)	LSB1	10.40	G
324000	91356	6.13"	2.44"	9/16" (3)	LSB1	9.95	G
324001	A2252CB34	7.75"	2.88"	9/16" (2) 3/4" (1)	LSB1 N/A	12.95	G
324002	458	6.25"	2.03"	9/16" (2) 3/4" (1)	LSB1 N/A	10.95	G

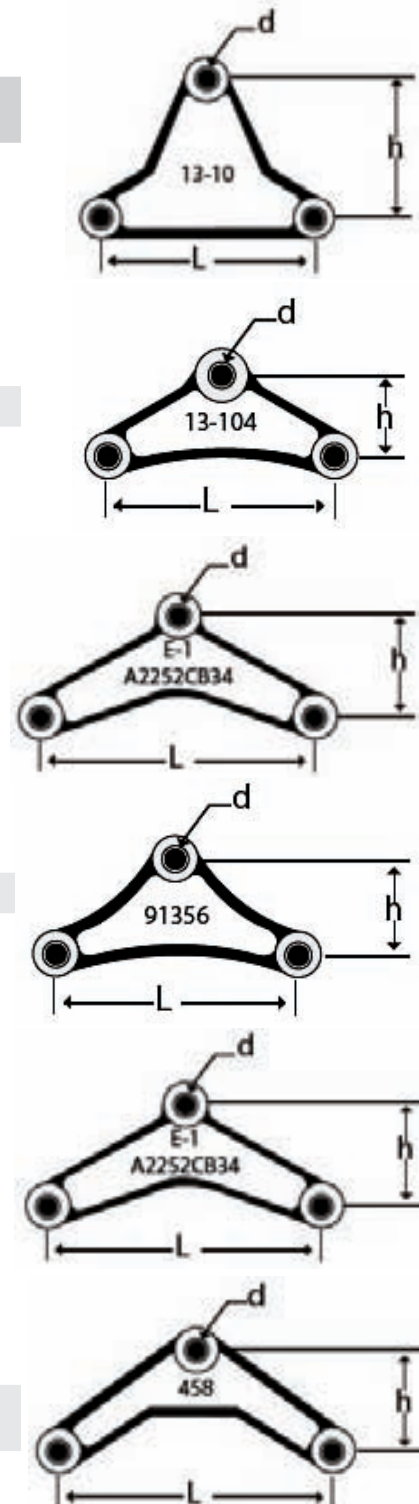

- tires & wheels
- axles, hubs & springs
- tongue accessories
- hitches
- electrical
- brake parts
- trailer hardware
- locks & pins
- towing & loading
- tie downs
- tools
- chemicals

TRAILER

AXLES, HUBS & SPRINGS

GREASEABLE WHEEL BEARING PROTECTORS

- tires & wheels
- axles, hubs & springs
- tongue accessories
- hitches
- electrical
- brake parts
- trailer hardware
- locks & pins
- towing & loading
- tie downs
- tools
- chemicals

TRAILER

BEARING BUDDY

- Sold in pairs only
- The ultimate in wheel bearing protection for your trailer
- Replaces dust cap on trailer hub for easy lubrication and maximum protection
- Prevents bearing failure, keeps water and dirt out of hubs
- Bearings receive constant lubrication, never need to be repacked
- Quick lubricant check level
- Quality construction: heavy chrome plated barrel, stainless steel internal parts



PART #	MFG #	FITS HUBS	OUTER BEARING	OUTER CUP	BUDDY BRA	U/M		
BB1781	41202	1-3/4"	LM11949	LM11910	BB17	PR	22.95	G
BB1980	42102	2"	LM44643 LM44649	LM44610	BB19	PR	25.95	G
BB2328	43102	2-5/16"	LM67048	LM67010	BB23	PR	27.95	G



BEARING BUDDY II WITH AUTO CHECK

- Sold in pairs only
- Visual lubricant and pressure indicator
- Fits 2" hubs
- Blue ring recessed

PART #	MFG #	FITS HUBS	OUTER BEARING	OUTER CUP	BUDDY BRA	U/M		
BB1985	42202	2"	LM44643	LM44610	BB19	PR	25.95	G



BEARING BUDDY BRA

- Sold in pairs only
- Bearing Buddy Bras fit over Bearing Buddys to capture grease that can be thrown onto the wheels when the automatic pressure relief feature releases excess grease
- Blister packaged

PART #	MFG #	FITS HUBS	BEARING BUDDY	U/M		
BB17	70017	1-3/4"	BB1781	PR	3.40	J
BB19	70019	2"	BB1980/ BB1985	PR	3.40	J
BB23	70023	2-5/16"	BB2328	PR	3.40	J



FULTON WHEEL BEARING PROTECTORS

- Sold in pairs only
- Provide permanent protection against damage from water and dirt entering the wheel bearings
- Prevent corrosion resulting from water entering the hub when the trailer wheels are suddenly submerged
- Automatically maintain the correct internal pressure - can not damage seals



PART #	MFG #	FITS HUBS	OUTER BEARING	OUTER CUP	COVER INCLUDED	PROTECTOR COVER	U/M	
FT178	BPC1780604	1-3/4"	LM11949,	LM11910	YES	444000	PR	12.12 E
FT198	BPC1980604	2"	LM44643/ LM44649	LM44610	YES	444001	PR	11.99 E
FT232*	BP232S0604	2-5/16"	LM67048	LM67010	NO	444002	PR	22.09 E
FT244**	BP244S0604	2-5/16"	LM67048	LM67010	NO	444002	PR	22.09 E



*FT232 HUB NOT COUNTER BORED. ** FT244 HUB COUNTER BORED.

GREASEABLE WHEEL BEARING PROTECTORS CONTINUED

TIE DOWN WHEEL BEARING PROTECTOR

- Sold in pairs only
- Pumps grease directly into bearing
- 1.98" OD
- 2 to a card
- Skin packaged



PART #	MFG #	FITS HUBS	OUTER BEARING	OUTER CUP	COVER INCLUDED	PROTECTOR COVER	U/M
LR81168	81168	2"	LM44643/ LM44649	LM44610	YES	N/A	PR 9.72 G

TIE DOWN WHEEL BEARING PROTECTOR COVER

PART #	MFG #	FITS HUBS	BEARING PROTECTOR	U/M
LR81174	81174	2"	LR81168	PR 3.39 G



NON GREASEABLE DUST CAPS

PART #	MFG #	SIZE	U/M
GCP34	GC-2	1-3/4"	EA 3.00 G
GCP10	16200	1-15/16"	EA 1.98 L
LR81167	81167	1-15/16"	PR 3.49 G
GCP14	001926	2-5/16"	EA 4.05 E
856658	6658	2-7/16"	PR 10.21 E
855652	5652	2-1/2"	EA 5.72 E



GCP34



LR81167

CONE BEARINGS AND BEARING CUPS ONLY

Sold each



CONE BEARING PART #	CONE BEARING MFG #	BEARING CUP PART #	BEARING CUP MFG #	SPINDLE SIZE	INSIDE DIAMETER	OUTSIDE DIAMETER
LM11949	LM-11949	5.50 L	LM11910	LM-11910	2.15 L	3/4" 0.75" 1.781"
LM44643	L44643	4.15 L	LM44610	L-44610	1.40 L	1" 1" 1.98"
LM44649	L-44649	3.25 L	LM44610	L-44610	1.40 L	1-1/16" 1.0625" 1.98"
LM67048	LM-67048	4.70 L	LM67010	LM-67010	2.25 L	1-1/4" 1.25" 2.328"
LM15123	LM15123	6.10 L	LM15245	15245	3.05 L	1-1/4" 1.25" 2.4409"
LM14125A	14125A	7.00 L	----			1-1/4" 1.25" 2.717"
LM68149	LM68149	5.10 L	LM68111	L-68111	1.75 L	1-3/8" 1.3775" 2.3612"
LM48548	LM48548	6.65 G	LM48510	LM-48510	3.25 L	1-3/8" 1.375" 2.5625"
LM25580	L-25580	8.55 L	LM25520	25520	4.80 L	1-3/4" 1.75" 3.265"

- tires & wheels
- axles, hubs & springs
- tongue accessories
- hitches
- electrical
- brake parts
- trailer hardware
- locks & pins
- towing & loading
- tie downs
- tools
- chemicals

TRAILER

AXLES, HUBS & SPRINGS

BEARING AND CUP PACKAGED

PART #	MFG #	SPINDLE SIZE	BEARING	CUP	INSIDE DIAMETER	OUTSIDE DIAMETER	WIDTH		
LM11949CC	L11940/11949CC	3/4"	LM11949	LM11910	0.75"	1.781"	0.61"	8.30	L
LM44643CC	LM44610/L44643	1"	LM44643	LM44610	1"	1.98"	0.56"	6.30	L
LM67048CC	L67010/67048	1-1/4"	LM67048	LM67010	1.25"	2.328"	0.625"	7.20	L
LM15123CC	LM15123/LM15245	1-1/4"	LM15123	LM15245	1.25"	2.4409"	0.715"	9.40	L
LM14125CC	L14125/14276	1-1/4"	LM14125A	LM14276	1.25"	2.717"	0.7813"	11.15	L
LM68149CC	LM68111/LM68149	1-3/8"	LM68149	LM68111	1.3775"	2.3612"	0.625"	7.45	L
LM48548CC	L48510/48548	1-3/8"	LM48548	LM48510	1.375"	2.5625"	0.71"	10.25	L
LM25580CC	LM25580/LM25520	1-3/4"	LM25580	LM25520	1.75"	3.265"	0.9375"	14.85	L

GREASE SEALS

PART #	MFG #	ID	OD	UM		
GS204020	GS-3	1.125"	1.780"	EA	1.95	G
LR81311	81311	1.125"	1.780"	PR	4.84	G
GS203025	12192TB	1.250"	1.980"	EA	1.35	L
LR81310	81310	1.250"	1.980"	PR	4.02	G
GS150198	15192TB	1.500"	1.987"	EA	1.40	L
GS203013	GS-4	1.500"	2.330"	EA	1.40	G
LR81312	81312	1.500"	2.330"	PR	4.84	G
GS545138	171255T	1.720"	2.565"	EA	1.60	L
LR81313	81313	1.720"	2.565"	PR	4.49	G
855607	5607	1.750"	2.330"	PR	7.36	E
855606	21333TB	2.125"	3.376"	EA	2.10	G
855605	22333TB	2.250"	3.376"	EA	1.60	G
856605	6605	2.750"	2.376"	PR	8.16	E



BEARING KITS

- Kits are retail packaged
- All kits are complete with 2 bearings, 2 cups, 1 grease seal, and 1 cotter pin



PART #	MFG #	SPINDLE SIZE	INNER BEARING	OUTER BEARING	INNER CUP	OUTER CUP	GREASE SEAL	COTTER PIN		
TBK3	WB750-0700	3/4"	LM11949	LM11949	LM11910	LM11910	GS204020	CP2	19.95	G
TBK1	WB100 0700	1"	LM44643	LM44643	LM44610	LM44610	GS203025	CP2	12.95	G
420001	----	1-1/16"	LM44649	LM44649	LM44610	LM44610	GS150198	CP2	9.95	G
TBK9	WB106-0700	1-1/16"	LM44649	LM44649	LM44610	LM44610	GS203025	CP2	12.95	G
TBK4	WB125-0700	1-1/4"	LM67048	LM67048	LM67010	LM67010	GS203013	CP2	12.95	G
TBK8	WB125T0700	1-1/4"-3/4"	LM67048	LM11949	LM67010	LM11910	GS203013	CP2	18.95	G
TBK5*	----	1-3/8"-1-1/16"	LM48548	LM44649	LM48510	LM44610	GS545138	CP2	14.95	G
TBK6*	WB138T0700	1-3/8"-1-1/16"	LM68149	LM44649	LM68111	LM44610	GS545138	CP2	14.95	G
TBK10	----	1-3/4"-1-1/4"	LM25580	LM67048	LM25520	LM67010	855605	CP2	19.95	G

*TBK5 = OLD STYLE HSH545 HUB, *TBK6 = NEW STYLE

RELIABLE SPINDLE KITS

- Kits are retail packaged
- All kits are complete with 2 bearings, 2 cups, 1 grease seal, 1 cotter pin, and 1 dust cap



PART #	MFG #	SPINDLE SIZE	U/M		
RL1130	1130	1"	KIT	25.95	G
RL1131	1131	1-1/16"	KIT	26.95	G
RL1134	1134	1-3/8"-1-1/16"	KIT	27.95	H

TRAILER

- tires & wheels
- axles, hubs & springs
- tongue accessories
- hitches
- electrical
- brake parts
- trailer hardware
- locks & pins
- towing & loading
- tie downs
- tools
- chemicals

TIE DOWN U-BOLTS

Pairs of U-bolts are packaged with nuts and washers.
All U-bolts are zinc plated to prevent rust.



LR86205

LR86217

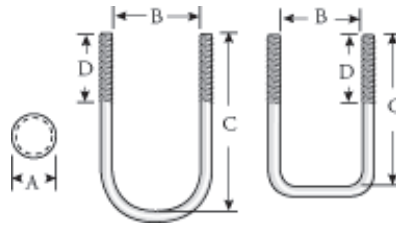

How to measure for u-bolts:

- A = Rod width - threads per inch
- B = Between leg length (inside thread)
- C = Leg length
- D = Thread length

PART #	MFG #	"A" ROD WIDTH	"B" BETWEEN LEG	"C" LEG LENGTH	"D" THREAD LENGTH	SQUARE/ ROUND	NUTS/ WASHERS	U/M		
LR83069	83069Z	3/8-16	3-1/8"	3"	1-3/4"	SQUARE	NO	EA	1.30	L
LR86209		3/8-16	3-1/8"	3"	1-3/4"	SQUARE	YES	PR	4.55	G
LR10978	10978Z	3/8-16	4-1/8"	3"	1-3/4"	SQUARE	NO	EA	1.40	G
LR86211		3/8-16	4-1/8"	3"	1-3/4"	SQUARE	YES	PR	4.75	G
LR83043	83043Z	3/8-16	1-5/8"	3-9/16"	1-3/4"	SQUARE	NO	EA	1.30	L
LR86219		3/8-16	1-5/8"	3-9/16"	1-3/4"	SQUARE	YES	PR	4.35	G
LR10975	10975Z	3/8-16	2-1/8"	4"	1-3/4"	SQUARE	NO	EA	1.40	G
LR86208		3/8-16	2-1/8"	4"	1-3/4"	SQUARE	YES	PR	4.75	G
LR10967	10967Z	3/8-16	1-3/4"	4-13/16"	1-3/4"	ROUND	NO	EA	1.60	G
LR86216		3/8-16	1-3/4"	4-13/16"	1-3/4"	ROUND	YES	PR	5.15	G
LR83707	83707Z	7/16-14	2-1/16"	2-5/16"	1"	SQUARE	NO	EA	1.30	L
LR86228		7/16-14	2-1/16"	2-5/16"	1"	SQUARE	YES	PR	4.85	G
LR83704	83704Z	7/16-14	4-1/16"	2-13/16"	1-3/4"	SQUARE	NO	EA	1.80	L
LR86234		7/16-14	4-1/16"	2-13/16"	1-3/4"	SQUARE	YES	PR	5.80	G
LR86230	83708Z	7/16-14	3-1/16"	3-5/16"	1-3/4"	SQUARE	YES	PR	5.80	G
LR10989	10989Z	7/16-14	1-9/16"	3-9/16"	2"	SQUARE	NO	EA	1.65	G
LR86212		7/16-14	1-9/16"	3-9/16"	2"	SQUARE	YES	PR	5.45	G
LR84051	84051Z	7/16-14	2-1/16"	4-5/16"	2"	SQUARE	NO	EA	2.01	L
LR86229		7/16-14	2-1/16"	4-5/16"	2"	SQUARE	YES	PR	6.05	G
LR83703	83703Z	7/16-14	3-1/16"	4-5/16"	2"	SQUARE	NO	EA	2.05	L
LR86231		7/16-14	3-1/16"	4-5/16"	2"	SQUARE	YES	PR	6.35	G
LR10981	10981Z	1/2-13	3-1/8"	3"	1-1/2"	SQUARE	NO	EA	1.95	G
LR86205		1/2-13	3-1/8"	3"	1-1/2"	SQUARE	YES	PR	6.55	G
LR10983	10983Z	1/2-13	4-1/8"	3"	2"	SQUARE	NO	EA	2.15	G
LR86207		1/2-13	4-1/8"	3"	2"	SQUARE	YES	PR	7.25	G
LR84430	84430Z	1/2-13	3-1/16"	3-13/16"	1-1/2"	SQUARE	NO	EA	2.25	L
LR86214		1/2-13	3-1/16"	3-13/16"	1-1/2"	SQUARE	YES	PR	7.15	G
LR84503	84503Z	1/2-13	2-1/8"	4"	2"	SQUARE	NO	EA	2.15	L
LR86204		1/2-13	2-1/8"	4"	2"	SQUARE	YES	PR	10.88	G
LR84470	84470Z	1/2-13	3-1/8"	4"	2"	SQUARE	NO	EA	2.35	L
LR86206		1/2-13	3-1/8"	4"	2"	SQUARE	YES	PR	7.35	G
LR10991	10991Z	1/2-13	1-9/16"	4-1/16"	2"	SQUARE	NO	EA	2.05	G
LR86213		1/2-13	1-9/16"	4-1/16"	2"	SQUARE	YES	PR	6.75	G
LR84406	84406Z	1/2-13	2-1/16"	4-13/16"	2"	SQUARE	NO	EA	2.45	L
LR86215		1/2-13	2-1/16"	4-13/16"	2"	SQUARE	YES	PR	7.55	G
LR84751	84751Z	1/2-13	2-3/8"	5-3/8"	2"	ROUND	NO	EA	2.65	L
LR86217		1/2-13	2-3/8"	5-3/8"	2"	ROUND	YES	PR	8.05	G
LR84758	84758Z	1/2-13	3-1/16"	6-11/16"	2"	ROUND	NO	EA	2.87	L
LR86218		1/2-13	3-1/16"	6-11/16"	2"	ROUND	YES	PR	9.50	G

- tires & wheels
- axles, hubs & springs
- tongue accessories
- hitches
- electrical
- brake parts
- trailer hardware
- locks & pins
- towing & loading
- tie downs
- tools
- chemicals

TRAILER

AXLES, HUBS & SPRINGS

TIE DOWN U-BOLT KITS

Used for mounting brackets to trailer frame. Zinc plated to help prevent rusting. Includes flat washers and nyloc nuts.

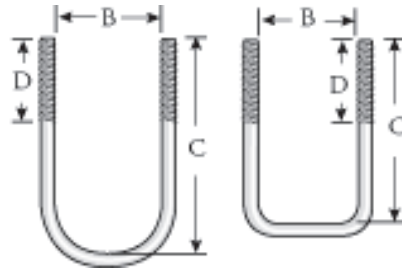

How to measure for u-bolts:

- A = Rod width - threads per inch
- B = Between leg length (inside thread)
- C = Leg length
- D = Thread length

PART #	MFG #	"A" ROD WIDTH	"B" BETWEEN LEG	"C" LEG LENGTH	"D" THREAD LENGTH	SHAPE	EACH/ PAIR		
LR86204	86204	1/2"-13	2-1/8"	4"	2"	SQUARE	PAIR	10.88	G
276005	86205	1/2"-13	3-1/8"	3"	1-1/2"	SQUARE	PAIR	9.47	G
276006	86206	1/2"-13	3-1/8"	4"	2"	SQUARE	PAIR	9.83	G
276007	86207	1/2"-13	4-1/8"	3"	2"	SQUARE	PAIR	10.02	G
276008	86208	3/8"-16	2-1/8"	4"	1-3/4"	SQUARE	PAIR	10.23	G
276009	86209	3/8"-16	3-1/8"	3"	1-3/4"	SQUARE	PAIR	9.18	G
276010	86210	3/8"-16	3-1/8"	4"	1-3/4"	SQUARE	PAIR	9.47	G
276011	86211	3/8"-16	4-1/8"	3"	1-3/4"	SQUARE	PAIR	9.63	G
276012	86212	7/16"-14	1-9/16"	3-9/16"	2"	SQUARE	EACH	5.26	G
276013	86213	1/2"-13	1-9/16"	4-1/16"	2"	SQUARE	EACH	6.20	G
276014	86214	1/2"-13	3-1/16"	3-13/16"	1-1/2"	SQUARE	EACH	6.10	G
276015	86215	1/2"-13	2-1/16"	4-13/16"	2"	SQUARE	EACH	6.51	G
276016	86216	3/8"-16	1-3/4"	4-13/16"	1-3/4"	ROUND	EACH	4.59	G
276017	86217	1/2"-13	2-3/8"	5-3/8"	2"	ROUND	EACH	6.87	G
276018	86218	1/2"-13	3-1/16"	6-11/16"	2"	ROUND	EACH	8.22	G
276019	86219	3/8"-16	1-5/8"	3-9/16"	1-3/4"	SQUARE	EACH	4.35	G
276020	86228	7/16"-14	1-9/16"	3-9/16"	2"	SQUARE	EACH	4.81	G
276021	86229	7/16"-14	2-1/16"	4-5/16"	2"	SQUARE	EACH	5.21	G
276022	86230	7/16"-14	3-1/16"	3-5/16"	1-3/4"	SQUARE	EACH	5.21	G
276023	86231	7/16"-14	3-1/16"	4-5/16"	2"	SQUARE	EACH	5.29	G
276024	86234	7/16"-14	4-1/16"	2-13/16"	1-3/4"	SQUARE	EACH	5.36	G

LOCK NUTS



PART #	MFG #	SIZE	U/M		
LR10627	10627	3/8"-16	EA	0.28	L
LR10654	10654	7/16"-14	EA	0.25	L
LR10645	10645	1/2"-13	EA	0.35	L

WASHERS



PART #	MFG #	SIZE	U/M		
LR10502	10502	3/8"	EA	0.20	L
LR10510	10510	7/16"	EA	0.25	L
LR10573	10573	1/2"	EA	0.25	L

SMITH U-BOLTS

- Contains parts to attach two springs to axle
- Includes 2 tie plates, 4 u-bolts, 8 locknuts, and washers



- tires & wheels
- axles, hubs & springs**
- tongue accessories
- hitches
- electrical
- brake parts
- trailer hardware
- locks & pins
- towing & loading
- tie downs
- tools
- chemicals

ZINC, YELLOW

PART #	MFG #	A ROD WIDTH	B BETWEEN LEG	C LEG LENGTH	D THREAD LENGTH	SQUARE/ ROUND	NUTS/ WASHERS	U/M		
CS22003	22003ZN	3/8"-16	1-5/8"	3-3/8"	2-1/2"	SQUARE	NO	EA	1.35	G
CS21008	21008ZN	3/8"-16	1-15/16"	4"	1-1/2"	ROUND	NO	EA	2.25	G
CS22017	22017ZY	1/2"-20	2.12"	4-1/2"	2"	SQUARE	NO	EA	3.59	G
CS21000	21000ZN	1/2"-20	3-1/8"	7"	2"	ROUND	NO	EA	2.15	G

ZINC PLATED



PART #	MFG#	A ROD WIDTH	B BETWEEN LEG	C LEG LENGTH	D THREAD LENGTH	SQUARE/ ROUND	NUTS/ WASHERS	U/M		
CS15251	15251	7-16"-14	2-1/8"	4"	2"	SQUARE	NO	EA	2.15	H
CS15252	15252	7-16"-14	3-1/8"	3"	2-1/4"	SQUARE	NO	EA	1.70	G
CS15253	15253	7-16"-14	3-1/8"	4"	2-1/4"	SQUARE	NO	EA	1.98	H
CS15254	15254	7-16"-14	4-1/8"	4"	2-1/4"	SQUARE	NO	EA	2.32	G

WASHERS



PART #	MFG #	SIZE	U/M		
CS10961	10961	7/16"	EA	0.20	J

LOCK NUTS



PART #	MFG #	SIZE	U/M		
CS10811	10811	7/16"-14	EA	0.17	H

ADDITIONAL U-BOLTS

PART #	MFG #	A ROD WIDTH	B BETWEEN LEG	C LEG LENGTH	D THREAD LENGTH	SQUARE/ ROUND	NUTS/ WASHERS	UM		
690950	11-54	3/8"-24	1-7/8"	4-1/4"	1-3/4"	ROUND	NO	EA	2.00	G
827046	US7301213Y	7/16"-14	3-1/16"	2-13/16"	2"	SQUARE	NO	EA	1.25	G
827048	US7301305G	7/16"-14	3-1/16"	3-5/16"	2"	SQUARE	NO	EA	1.95	G
827050	US7301405Y	7/16"-14	3-1/16"	4-5/16"	2"	SQUARE	NO	EA	1.50	G

TRAILER

- tires & wheels
- axles, hubs & springs
- tongue accessories
- hitches
- electrical
- brake parts
- trailer hardware
- locks & pins
- towing & loading
- tie downs
- tools
- chemicals

TRAILER

PYRAMID WASHERS

PART #	MFG #	SIZE	U/M
CS10805	10805	3/8"	PKG 4 2.40 G
CS10806	10806	7/16"	PKG 4 2.40 G

RELIABLE U-BOLTS



U-BOLTS SOLD EACH

PART #	MFG #	LEG WIDTH	LENGTH	BOLT DIA.	THREAD LENGTH	U/M
230045	UB-R-120	1-3/4"	4-1/4"	1/2"	2"	EA 3.70 G
230046	UB-R-220	2-1/2"	5-1/4"	1/2"	2-1/4"	EA 4.30 G
230047	UB-R-320	3-1/8"	6"	1/2"	2"	EA 5.50 G
230048	UB-R-322	3-1/8"	7"	1/2"	2"	EA 6.35 G
230049	UB-S-220	2-1/8"	4-1/2"	1/2"	2"	EA 4.90 G

ITEM	PART #	MFG #	SIZE	U/M
WASHER	230051	SW1001	1-1/16"	EA 3.85 G
LOCK NUT	230040	N-101	1/2"	EA 0.60 G

U-BOLT KITS

- Each kit contains:
 - 4 u-bolts
 - 2 tie plates
 - 8 lock nuts & washers
- Display packaged

PART #	MFG #	AXLE SIZE	AXLE STYLE	BETWEEN LEG	U/M
RL3001	3001	1-3/4"	ROUND	1-1/4"	PKG 23.90 G
RL3003	3003	2-3/8"	ROUND	1-1/4"	PKG 32.95 G
RL3005	3005	3"	ROUND	1-3/4"	PKG 32.95 G
RL3011	3011	2"	SQUARE	1-3/4"	PKG 28.95 G



Display packaged



Back View

All u-bolts are:

- 1/2"-20 thread
- Zinc plated
- Boxed (bulk)

PART #	MFG #	AXLE SIZE	AXLE STYLE	U-BOLT	TIE PLATE	LOCK NUTS	U/M
75-1010	UBK-R120	1-3/4"	ROUND	230045	230041	230040	PKG 25.05 G
75-1014	UBK-R220	2-3/8"	ROUND	230046	230042	230040	PKG 34.95 H
75-1016	UBK-R320	3"	ROUND	230047	230043	230040	PKG 32.65 G
75-1018	UBK-R322	3"	ROUND	230048	230043	230040	PKG 35.60 G
75-1022	UBK-R372	3"	ROUND	230048	230044	230040	PKG 37.80 G
75-1026	UNK-S220	2"	SQUARE	230049	230044	230040	PKG 34.40 G

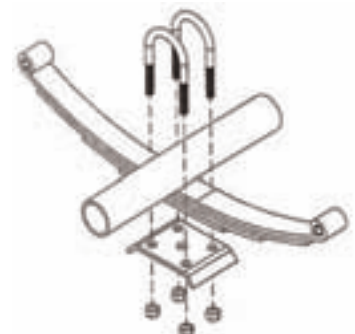

SMITH AXLE TIE PLATES

Galvanized steel • 1/4" thick



FORMED

PART #	MFG #	A	B	C	D	U-BOLT	HOLE DIAMETER	U/M		
CS20001	20001G	5.83"	2.94"	2.31"	3.75"	1/2"	.56"	EA	5.45	H
CS20003	20003G	5.83"	3.62"	2.26"	3.75"	1/2"	.56"	EA	4.35	H

FLAT

PART #	MFG #	A	B	C	D	U-BOLT	HOLE DIAMETER	U/M		
CS20015	20015G	3.5"	2.25"	2.25"	3.5"	3/8"	.44"	EA	4.05	H
CS20022	20022G	3.5"	2.25"	2"	3"	3/8"	.44"	EA	1.97	H
CS20023	20023GA	4"	2.63"	2.38"	3.81"	1/2"	.56"	EA	3.80	G
CS20044	20044GA	5"	2.75"	2.38"	3.75"	1/2"	9/16"X13/16" SLOTS	EA	5.20	G

THREE HOLE FLAT

PART #	MFG #	A	B	C	U-BOLT	UM		
CS20024	20024G	5"	3.56"	1.5"	1/2"	EA	2.35	H

AXLE TIE PLATES

Oiled Finish • 1/4" Thick • These plates are recommended for 3" round axles • Sold each (bulk)

PART #	MFG #	A	B	C	D	U/M		
828864	4201-3	2.3/8"	3-5/8"	11/16"	1/2"	EA	4.95	D

TWO HOLE FLAT

PART #	MFG #	A	B	C	D	U/M		
828474	28-01255-0	N/A	4-1/2"	N/A	1/2"	EA	2.10	H

TIE DOWN TIE PLATE

Sold 2 to a package

PART #	MFG #	A	B	C	D	U-BOLT	HOLE DIAMETER	U/M		
LR81186	81186	5"	2-15/16"	2-1/2"	3-3/4"	1/2"	9/16"X13/16" SLOTS	PR	9.00	G

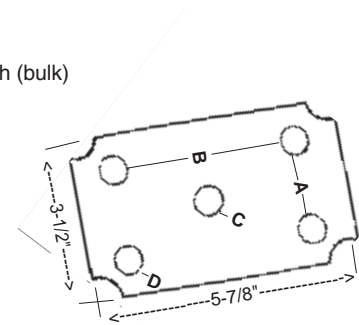
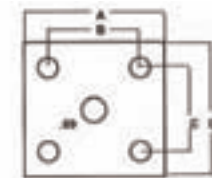
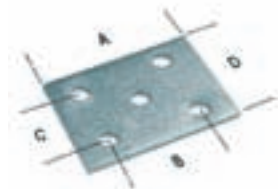
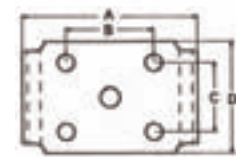
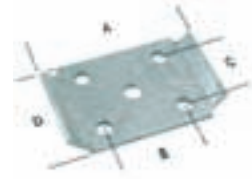

- tires & wheels
- axles, hubs & springs
- tongue accessories
- hitches
- electrical
- brake parts
- trailer hardware
- locks & pins
- towing & loading
- tie downs
- tools
- chemicals

TRAILER

AXLES, HUBS & SPRINGS

AXLE TIE PLATES

PART #	MFG #	A LONG LENGTH	B SHORT LENGTH	C BOLT SPACE LONG	D BOLT SPACE SHORT	HOLE DIA.	U/M		
230041	TP-R-120	3-1/2"	3-1/2"	2-1/4"	2-1/4"	1/2"	EA	5.90	G
230042	TP-R-220	5-1/2"	3-1/2"	3"	2-1/2"	1/2"	EA	9.95	G
230043	TP-R-320	5-3/4"	3-1/2"	3-1/2"	2-1/4"	1/2"	EA	9.70	G
230044	TP-R-370	5-3/4"	4"	3-1/2"	2-1/2"	1/2"	EA	10.40	G
230050	TP-S-220	3-3/4"	3-3/4"	2-3/4"	2-3/4"	1/2"	EA	7.65	G

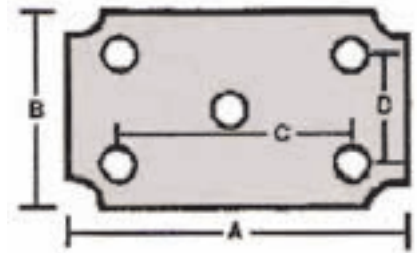

TIE DOWN AXLE TIE PLATE KITS

- Each kit contains:
 - 4 u-bolts
 - 8 lock nuts
 - 2 five hole tie plates
- Display packaged

PART #	MFG #	AXLE SIZE	AXLE STYLE	U/M		
LR81175	81175	1.90"	ROUND	PKG	24.19	G
LR81180	81180	2-3/8"	ROUND	PKG	28.28	G
LR81185	81185	2"	SQUARE	PKG	35.82	G

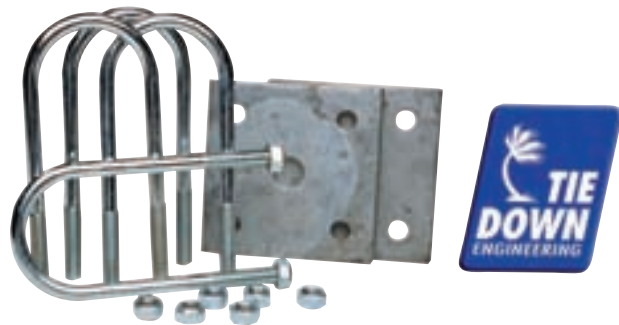

SMITH AXLE TIE PLATE KITS

- Zinc, yellow u-bolts
- Fits 1-3/4" wide springs
- Contains parts to attach 2 springs to axle
- Galvanized plates
- Includes: 2 tie plates, 4 u-bolts, 8 locknuts, & washers
- Display packaged

PART #	MFG #	AXLE SIZE	AXLE STYLE	U/M		
CS23000	23000	1-3/4"	ROUND	PKG	26.75	G
CS23002	23002	2-3/8"	ROUND	PKG	37.60	G
CS23003	23003	3"	ROUND	PKG	33.50	G
CS23102	23102	1-1/2"	SQUARE	PKG	18.95	G
CS23103	23103	2"	SQUARE	PKG	29.00	G



SMITH U-BOLT WITH FRAME STRAP

- Zinc plated u-bolts with straps offer extra strength and security when attaching parts or accessories to trailer frame
- Straps are 1-1/4" wide and hot dipped galvanized for protection
- Washers and nuts are also included
- Display packaged

PART #	MFG #	U-BOLT WIDTH	U-BOLT LENGTH	STRAP LENGTH	U/M	
CS15903	15903	4-1/8"	3"	6"	PKG	9.05 H



TRAILER

SMITH FRAME STRAPS

- Heavy 1/4" steel
- Use with 7/16" or 1/2" diameter u-bolts or shackle bolts

GALVANIZED FINISH



PART #	MFG #	LENGTH	HOLE CENTER	WIDTH	BOLT HOLE SIZE	U/M			
CS20016	20016G	4"	2-9/16"	1-1/4"	.565"	EA	1.80	J	
CS20017	20017G	5"	3-1/2"	1-1/4"	.565"	EA	1.95	H	
CS20018	20018G	4"	2.58"	1"	.565"	EA	1.85	H	
CS20028	20028G	6"	4.53"	1-1/4"	.565"	EA	2.52	G	

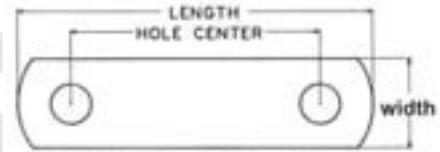

PLAIN FINISH

PART #	MFG #	LENGTH	HOLE CENTER	WIDTH	BOLT HOLE SIZE	U/M			
690962	14100G	4-3/8"	3-1/4"	1-1/4"	9/16"	EA	2.81	AE	

TIE DOWN FRAME STRAPS

- Used on double eye springs
- 1/4" thick plated steel
- Skin packaged (each)



PART #	MFG #	LENGTH	HOLE CENTER	WIDTH	BOLT HOLE SIZE	U/M			
LR86276	86276	4-3/8"	3-1/4"	1-1/4"	9/16"	EA	7.54	G	

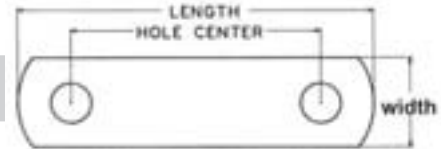

TIE DOWN SPRING HANGERS - WELD-ON

- Weld-on
- Sold each
- Front bracket and rear "C" clip bracket
- Use with 1-3/4" spring and 9/16" shackle bolt



PART #	MFG #	A	B	C	STYLE	LOCATION	WEIGHT LIMIT PER AXLE	U/M		
LR86274	86274	2-1/4"	1-1/2"	1-1/2"	1	FRONT	1000#-3500#	EA	4.78	G
LR86275	86275	2"	1"	1"	2	REAR	5200#-8000#	EA	4.04	G

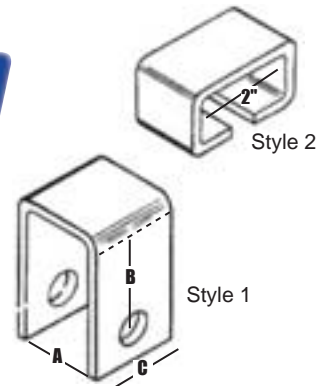

SMITH SPRING HANGERS - BOLT ON

- Hot-dipped galvanized brackets bolt beneath trailer frame
- For light duty use with 1-3/4" slipper springs
- Front bracket length of 2-1/4"
- Made of 7 gauge steel
- Uses 9/16" shackle bolt below



PART #	MFG #	SPRING	LOCATION	BOLT	LENGTH	U/M			
CS14016	14016G	1-3/4"	FRONT	9/16"	2-1/4"	EA	10.95	G	
CS14017	14017G	1-3/4"	REAR	9/16"	2-1/2"	EA	9.85	G	



- tires & wheels
- axles, hubs & springs
- tongue accessories
- hitches
- electrical
- brake parts
- trailer hardware
- locks & pins
- towing & loading
- tie downs
- tools
- chemicals

TRAILER

AXLES, HUBS & SPRINGS

SMITH FLUTED SHACKLE BOLTS AND NUTS

- For use with spring hanger brackets
- Fluting prevents the bolt from turning, which can wear hanger brackets
- Case hardened grade 5 steel



SOLD EACH

PART #	MFG #	DESCRIPTION	SIZE	THREAD	LENGTH	U/M
CS11030B	11030	BOLT	9/16"	18NF	3"	EA 2.29 L
CS11031B	11031	BOLT	9/16"	18NF	3-1/2"	EA 2.19 L
CS10864	10864	NUT	9/16"	18NF	N/A	EA 0.63 L

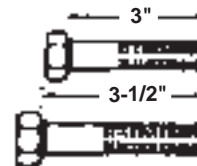

2 BOLTS AND 2 NUTS PER PACKAGE

PART #	MFG #	DESCRIPTION	SIZE	THREAD	LENGTH	U/M
230015	230015	BOLT AND NUT	9/16"	18NF	3"	PKG 5.95 L
230016	230016	BOLT AND NUT	9/16"	18NF	3-1/2"	PKG 4.25 L



SPRING SLIDERS

- Bolt-On
- Galvanized
- Spring Sliders allow you to adjust tongue weight to a specific load
- Ideal for bolt-on suspension for both the OEM and replacement applications

PART #	MFG #	SPRING STYLE	SPRING LENGTH	SIDE	U/M
823057	24-03057	DOUBLE EYE	27"	RIGHT	EA 27.50 A
823059	24-03059	DOUBLE EYE	27"	LEFT	EA 27.50 A

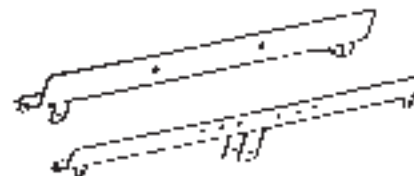

TIE DOWN HEX HEAD BOLTS

- Use for mounting brackets, couplers, and winch stands
- Grade 5, zinc plated steel
- Package contains 4 bolts, 4 washers, and 4 lock nuts

PART #	MFG #	SIZE	LENGTH	U/M
LR86256	86256	7/16"	1"	PKG 2.50 B



TRAILER

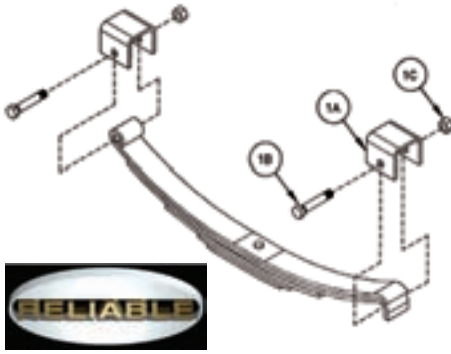

SINGLE AXLE HANGER KIT - SLIPPER STANDARD DUTY (1-3/4" SPRING)

DETAIL	PART #	MFG #	DESCRIPTION	KIT QTY		
	75-1000	HK1-S100	SINGLE AXLE HANGER KIT (1-3/4" SPRING)	COMPLETE	18.50	G
1A	75-101	HG-101	Front, rear hanger - 1.44"	4	3.50	G
1B	CS11030B	11030	Bolt - 9/16" - 18 x 3" long	4	2.29	L
1C	CS10864	10864	Nut - 9/16" - 18 NFT	4	0.63	L

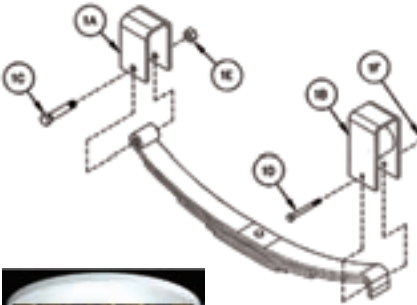

SINGLE AXLE HANGER KIT - SLIPPER HEAVY DUTY (2" SPRING)

DETAIL	PART #	MFG #	DESCRIPTION	KIT QTY		
	75-1002	HK1-S201	SINGLE AXLE HANGER KIT (2" SPRING)	COMPLETE	68.60	H
1A	75-103	HG-103	Front hanger - 4.25"	2	7.40	H
1B	75-105	HG-105	Rear hanger - 5.30"	2	26.05	G
1C	CS11031B	11031	Bolt - 9/16" - 18 x 3-1/2" long	2	2.19	L
1D	75-110	B-100	Bolt - 5/16" - 18 x 3-1/2" long	2	1.15	H
1E	CS10864	10864	Nut - 9/16" - 18 NFT	2	0.63	L
1F	75-112	N-100	Nut - 5/16" - 18 NFT	2	0.20	ZB

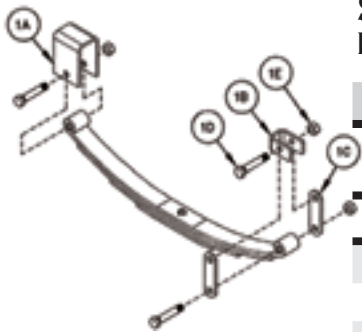

SINGLE AXLE HANGER KIT - DOUBLE EYE (SHORT & LONG) - (1-3/4" SPRING)

DETAIL	PART #	MFG #	DESCRIPTION	KIT QTY		
	75-1100	HK1-D100	SINGLE AXLE HANGER KIT (SHORT)	COMPLETE	20.45	B
	75-1101	HK1-D101	SINGLE AXLE HANGER KIT (LONG)	COMPLETE	37.95	G
1A	75-101	HG-101	Front hanger for 75-1100 - 1.44"	2	3.50	G
1A	75-102	HG-102	Front hanger for 75-1101 - 3.25"	2	5.70	G
1B	75-100	HG-100	Rear hanger - 1.12"	2	2.05	H
1C	75-120	SHL-102	Shackle link - 3-1/8" hole centers	4	2.10	H
1D	CS11030B	11030	Bolt - 9/16" - 18 x 3" long	6	2.29	L
1E	CS10864	10864	Nut - 9/16" - 18 NFT	6	0.63	L

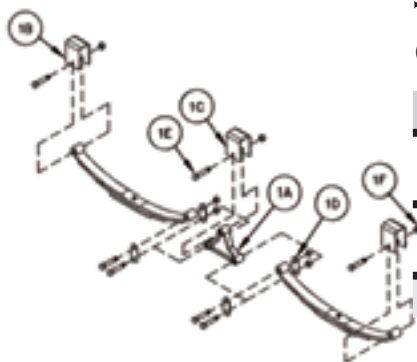

TANDEM AXLE EQUALIZER KIT - (SHORT & LONG) - (1-3/4" SPRING)

DETAIL	PART #	MFG #	DESCRIPTION	KIT QTY		
	75-1102	EK2-D102	TANDEM AXLE EQUALIZER KIT (SHORT)	COMPLETE	82.65	G
	75-1103	EK2-D103	TANDEM AXLE EQUALIZER KIT (LONG)	COMPLETE	92.10	H
1A	690990	13-10	Equalizer bar	2	10.40	G
1B	75-101	HG-101	Front, center, rear hanger for 75-2102 - 1.44"	6	3.50	G
1C	75-102	HG-102	Front, center, rear hanger for 75-2103 - 3.25"	6	5.70	G
1D	75-120	SHL-102	Shackle link - 2" hole centers	8	2.10	H
1D	CS11030B	11030	Bolt - 9/16" - 18 x 3" long	14	2.29	L
1E	CS10864	10864	Nut - 9/16" - 18 NFT	14	0.63	L



- tires & wheels
- axles, hubs & springs
- tongue accessories
- hitches
- electrical
- brake parts
- trailer hardware
- locks & pins
- towing & loading
- tie downs
- tools
- chemicals

TRAILER

- tires & wheels
- axles, hubs & springs
- tongue accessories
- hitches
- electrical
- brake parts
- trailer hardware
- locks & pins
- towing & loading
- tie downs
- tools
- chemicals

MARINE CORROSION CONTROL & TRAILER BEARING GREASE

- A sophisticated lubricant for use in severe operating conditions caused by salt water and salt air
- Water resistant, rust and corrosion preventative
- Recommended for all corrosion marine applications as well as boat trailers, wheel bearings including disc brake bearings



DESCRIPTION	QTY/CS	PART #	MFG #	
1 lb Resealable Tub	12	LB11404	11404	11.60 G
14 oz Cartridge	10	LB11402	11402	9.40 G

WHITE LITHIUM GREASE

- Includes zinc additives for a clean, white color
- Ideal for general home, shop, marine, snowmobile and industrial applications
- Provides superior performance and protection in most weather and temperature conditions



DESCRIPTION	QTY/CS	PART #	MFG #	
1 lb Resealable Tub	12	LB11350	11350	8.40 G
14 oz Cartridge	10	LB11354	11354	8.40 G

LEVER ACTION GREASE GUN

- Three way loading
- Heavy duty performance
- Display carton packaging
- Uses 14 oz. cartridge
- Zinc plated for maximum rust and corrosion resistance



DESCRIPTION	PART #	MFG #	
Lever Action Grease Gun	LB11155	30-465	28.95 G

PROFESSIONAL GREASE GUN

- Air bleeder valve eliminates air lock
- Comfort grip lever handle
- Uses standard 14 oz. grease cartridge
- Imported



DESCRIPTION	PART #	MFG #	
Professional Grease Gun	W54202	W54202	17.95 G

12" FLEXIBLE HOSE

This grease gun hose features steel 1/8" NPT male fittings on each end. Good for up to 3,000 PSI recommended working pressure. 12,000 PSI burst pressure. This hose is intended for use on hand-operated grease guns. Flexible whip.



DESC.	PART #	MFG #	
12" Hose	LB11825	10-212	7.50 G

MIDGET GREASE GUN KIT

- The ideal tool for the do-it-yourselfer
- Includes one midget gun and one 3 oz. cartridge of multi-purpose grease
- 2-way loading coupler has ball check to prevent leakage



DESCRIPTION	PART #	MFG #	
Grease Gun Kit	1727	30-192	22.15 G

HEAVY DUTY, LITHIUM BASE GREASE

Long lasting formula delivers high performance for a wide range of heavy-duty applications.



DESCRIPTION	PART #	MFG #	
Package of 4	1728	11300	14.80 G



TONGUE ACCESSORIES



TONGUE ACCESSORIES

F2 JACKS - TWIN & WIDE TRACK (1600 lbs)

Fulton, the industry leader for high performance marine jacks, is proud to introduce a revolution in trailer jack engineering. The F2, designed for use with marine, recreational and utility trailers, continues the Fulton heritage of innovation rethinking every feature and challenging industry conventions. The result is a re-engineered high quality product that will transform the industry. It's so strong and reliable that Fulton is backing it with an unprecedented LIMITED LIFETIME WARRANTY

- Maintenance free - designed to eliminate the need for lubrication and maintenance
- Corrosion resistant coatings cover internal and external components - will hold up in harsh environments
- Ergonomic design - crank, release pin and integrated wheel wedge are made of strong, engineered plastic for a comfortable touch



DESCRIPTION	PART #	MFG #	
F2™ Jack, 1,600 lbs., Twin Track	444177	141302134	267.97 B
F2™ Jack, 1,600 lbs., Wide Track	444178	141304134	267.97 B

REPLACEMENT PARTS

DESCRIPTION	PART #	MFG #	
Service Kit - F2 Handle/Crank Kit	444179	500134	25.69 B
Service Kit - F2 Handle Holdup	444180	500129	9.50 B
Service Kit - F2 Gearbox Cover Replacement	444181	500135	8.93 B
Service Kit - F2 Pull Pin Replacement	444182	500136	8.93 B
Replacement Part - 2 Washers	444183	500137	4.56 B
Kit - F2 3 x 4 Mount w/ Hardware	444184	500277	31.83 B
Replacement Part - F2 Gear Kit, Includes: Shim Washer 5/16" (1), Straight Pin 7/32" x 3/4" (1), Groove Pin 3/16" x 1-1/4" (1) & Washer 1/2" ID x 1-1/4" OD (1)	444185	500314	16.20 B
Jack Accessory, XP to F2 Adapter Kit, For F2 Swivel Mount w/4" Frame	444186	500320	37.73 B
Service Kit - F2 Twin Track Wheel Replacement	444187	500130	60.34 B
Service Kit - F2 Twin Track Wheel	444188	500138	27.02 B
Service Kit - F2 Twin Track Wheel Wedge	444189	500132	22.72 B
Service Kit - F2 Wide Track Wheel Replacement	444190	500131	47.62 B
Service Kit -F2 Wide Track Wheel Wedge	444191	500133	25.69 B



PRO SERIES™ POWERED JACK (2500 lbs)

- 18" travel.
- Integrated circuit breaker.
- Works in case of power loss with supplied manual override crank handle.
- Gloss black painted outer tube and motor assembly, clear zinc inner tube.
- Limited 1-year warranty.

PART #	MFG #	
444175	500198	209.47 B

REPLACEMENT PARTS

DESCRIPTION	PART #	MFG #	
Drive Pin & Coupling	444176	500204	39.82 B



SWIVEL JACK (1000 lbs)

- Retaining swivel ring
- Zinc finish for dependable long life
- Fits up to 3" x 5" tongue frames
- Includes all mounting hardware
- Rugged 6" poly wheel
- Heavy duty swivel retaining ring with multiple locking positions
- Spring-loaded locking pin for safe secure operation
- Easy-service gear box
- Grease fitting for easy lubrication
- 1 year warranty
- Boxed for display

FULTON

Top A	Retracted Length B	Extended Length C
10-1/2"	13"	23"

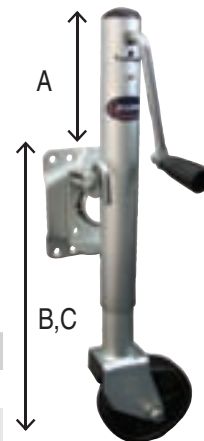

REPLACEMENT PARTS

DESCRIPTION	PART #	MFG #		
Wheel Kit	FT502	6811S00	15.36	E
Handle Kit	FT5027	0933301S00	17.31	E

PART #	MFG #		
FT800	EJ10000101	48.53	E

MARINE/RECREATIONAL SWIVEL JACK (1200 lbs)

- Retaining swivel ring operation
- Quickly and easily installed
- Complete with replaceable 6" poly wheel
- Fits all trailer tongues up to 3 x 5"
- Zinc plated
- 5 year warranty
- Boxed for display

FULTON

Top A	Retracted Length B	Extended Length C
11"	13"	23"

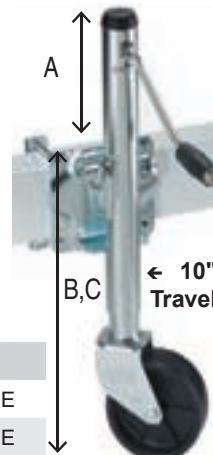

REPLACEMENT PARTS

DESCRIPTION	PART #	MFG #		
Wheel Kit	FT502	6811S00	15.36	E
Handle Kit	FT5027	0933301S00	17.31	E

PART #	MFG #		
FT503	XP100101	79.39	E

DELUXE JACK (1500 lbs) WITH BOLT THROUGH SWIVEL ATTACHMENT

- Heavy duty swivel mechanism combines ease of operation with superior load carrying capabilities
- Operates in seconds with new pull-pin swivel release
- 1:1 sidewind gear ratio provides fast, easy jack operation
- Heavy duty 2.25" zinc plated steel tubing
- Quick and easy installation
- 8" reinforced poly wheel (replaceable)
- Fits trailer tongues up to 3" x 5" x 5"
- Boxed for display

FULTON

Top A	Retracted Length B	Extended Length C
13"	12.75"	23"

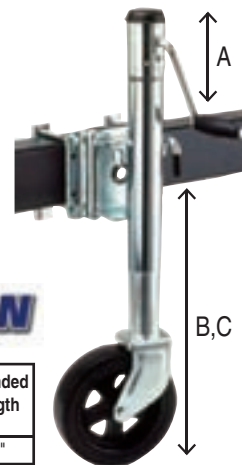

PART #	MFG #		
FT505	XP150101	113.58	E

DUAL WHEEL HEAVY DUTY JACK (1500 lbs) WITH BOLT THROUGH SWIVEL ATTACHMENT

- Heavy duty swivel mechanism combines ease of operation with superior load carrying capabilities
- 1,500 lb. capacity heavy duty dual wheel swivel jack features two (2) 6" wide profile wheels for maximum ground support
- Ideal for use on soft surfaces
- Welded independent castoring under heavy loads
- Quick and easy trailer installation
- Fits trailer tongues up to 3" x 5"
- Zinc plated
- Boxed for display

FULTON

Top A	Retracted Length B	Extended Length C
12"	12.75"	23"



PART #	MFG #		
FT125	XPD15L0101	136.08	E

- tires & wheels
- axles, hubs & springs
- tongue accessories
- hitches
- electrical
- brake parts
- trailer hardware
- locks & pins
- towing & loading
- tie downs
- tools
- chemicals

TRAILER

TONGUE ACCESSORIES

SWING AWAY MARINE JACK

- 1000 lb lift capacity
- 10" travel
- Sidewind
- 14-3/4" retracted, 24-3/4" extended
- 6" wheel
- Bolt-on mounting bracket fits up to 3" x 5" trailer frame
- Easy installation; all mounting hardware included
- Zinc finish
- Full color retail package



PART #	MFG #		
BY1610	0091610	58.95	E

ELECTRIC JACK

- 12 volt DC powered with manual crank over-ride
- 3,500 lbs lifting capacity (assists hitch ball release)
- Hardened steel gears
- Over-sized, 5 1/4" diameter foot pad prevents divots
- Zinc plated foot is adjustable on 1 1/2" centers (detachable)
- Weather sealed switch
- 26 1/2" overall height
- Retail packaged



Universal bolt-pattern for a-frame hitch



Manual crank over-ride included



PART #	MFG #		
BY3500	0093500	202.95	B

TUBE MOUNT SWIVEL JACK

Tube mount swivel jacks offer the convenience of a swivel mechanism with the durability needed for commercial, agricultural, and industrial markets



PART #	MFG #		
BY91205	0091205	35.95	H
BY91215	0091215	41.95	G
BY91220	0091220	48.95	H

REPLACEMENT PARTS

DESCRIPTION	PART #	MFG #	
Pin Kit For Mount	BY912TS	00912TS	5.85 G

A-FRAME JACK

- A-frame jacks are engineered to meet heavy-duty demands of today's rental, RV, industrial, agricultural, commercial and marine trailers
- High strength triangular steel mounting brackets provide easy bolt-on or weld-on mounting and ensure years of trouble free service
- Both jacks are sold with the foot base



- tires & wheels
- axles, hubs & springs
- tongue accessories**
- hitches
- electrical
- brake parts
- trailer hardware
- locks & pins
- towing & loading
- tie downs
- tools
- chemicals

DESCRIPTION	PART #	MFG #		
2000# A-Frame Jack w/Support Foot	BY91260	0091260	35.95	G
2000# A-Frame Jack Only	BY91261	0091261	30.95	H
5000# A-Frame Jack w//Support Foot	BY91265	0091265	41.95	G

REPLACEMENT PARTS

DESCRIPTION	PART #	MFG #		
Foot Base Only	BY91269	0091269	8.45	G

2 1/2" SQUARE JACK TOP WIND

- Fabricated from high strength, telescoping steel tubing
- Corrosion-resistant finish and high efficiency cranking mechanism give a long lasting, easy operating jack
- 7000# capacity
- 26" travel
- Retracts 22.38"
- Extends 38"



REPLACEMENT PARTS

PART #	MFG #			DESCRIPTION	PART #	MFG #		
BY91310	0091310	81.95	H	Handle Assembly	BY5522	3005222A	4.95	L

2 1/2" SQUARE JACK SIDE WIND

- Fabricated from high strength, telescoping steel tubing
- Corrosion-resistant finish and high efficiency
- Cranking mechanism give a long lasting, easy operating jack
- 7000# capacity
- 26" travel
- Retracts 25.75"
- Extends 41"



REPLACEMENT PARTS

PART #	MFG #			DESCRIPTION	PART #	MFG #		
BY91340	0091340	91.95	G	Handle Assembly	BY5525	3005525A	6.70	L
				Cap With Screw	BY5526	3005526	3.45	H

TRAILER

TONGUE ACCESSORIES

- tires & wheels
- axles, hubs & springs
- tongue accessories**
- hitches
- electrical
- brake parts
- trailer hardware
- locks & pins
- towing & loading
- tie downs
- tools
- chemicals

POWERED A-FRAME JACK

Tough & Trusted BULLDOG presents a Powered Jack with all the capacity and features you want.

- Positions quickly with 22" of total travel
- 3500 lb. lift capacity
- Integrated gearbox and motor
- Integrated gearbox and motor
- Drop leg
- Deploys and hooks up easily at night with onboard LED courtesy light, angled to illuminate coupler
- Works in case of power loss with emergency manual override capability, easily accessible from the top, crank included
- Lasts for years with industry-leading BULLDOG performance, known worldwide for unmatched strength, durability, and side load capacity
- Retains like-new appearance with corrosion-resistant surfaces
- Limited 5-year warranty



DESCRIPTION	PART #	MFG #		
3,500 lbs. Powered A-Frame Jack, Black Case	444167	500187	287.28	B
3,500 lbs. Powered A-Frame Jack, White Case	444168	500188	287.28	B

REPLACEMENT PARTS / ACCESSORIES

DESCRIPTION	PART #	MFG #		
Black Cover w/Mounting Screws	444173	500305	64.80	B
White Cover w/Mounting Screws	444174	500306	64.80	B
Manual Override Cover	444170	500201	6.07	B
LED Light Assembly	444171	500202	20.92	B
Manual Override Crank	444172	500203	25.98	B
Removable Disc Foot w/Snapper Pin	444169	500190	40.37	B



TRAILER



BULLDOG SQUARE JACK

5000# Support Capacity • 3000# Lift Capacity • Top Wind



A-FRAME

- Fixed leg less base
- Drop leg offers 13.50" additional adjustment

CAPACITY	TRAVEL	RETRACTED	EXTENDED	CLEARANCE
5000#	15"	7.40"	22.40"	14.70"

PART #	MFG #		
FT530	195321	84.67	E

tires & wheels

axles, hubs & springs

tongue accessories

hitches

electrical

brake parts

trailer hardware

locks & pins

towing & loading

tie downs

tools

chemicals

BULLDOG SQUARE JACKS

Tubular Swivel Mount • Round • 5000# Support Capacity • 3000# Lift Capacity



TOP WIND

- Fixed leg with base (pipe mount)
- Includes male mating mount, pin, and chain

SIDE WIND

- Fixed leg with base (pipe mount)
- Includes male mating mount, pin, and chain

CAPACITY	TRAVEL	RETRACTED	EXTENDED	CLEARANCE
5000#	15"	15.20"	30.20"	7.00"

CAPACITY	TRAVEL	RETRACTED	EXTENDED	CLEARANCE
5000#	15"	15.10"	30.10"	9.25"

PART #	MFG #		
FT536	195306	93.07	E

PART #	MFG #		
FT537	195356	101.95	E

BULLDOG SQUARE JACK

Tubular Swivel Mount • 8000# Support Capacity • 5000# Lift Capacity



TOP WIND

- Fixed leg with heavy duty base
- Painted outer tube
- Zinc plated inner tube
- Includes male mating mount, pin, and chain

CAPACITY	TRAVEL	RETRACTED	EXTENDED	CLEARANCE
8000#	10"	11.41"	21.41"	4.25"

PART #	MFG #		
FT532	190705	116.60	E

BULLDOG SQUARE JACK

Direct Weld • 10,000# Support Capacity • 7200# Lift Capacity



TOP WIND

- Drop leg with heavy duty base
- Drop leg offers 10.12" additional adjustment
- Painted outer tube
- Zinc plated inner tube

CAPACITY	TRAVEL	RETRACTED	EXTENDED
10,000#	10"	18.18"	38.31"

PART #	MFG #		
FT534	180304	140.13	E

TRAILER

TONGUE ACCESSORIES

- tires & wheels
- axles, hubs & springs
- tongue accessories
- hitches
- electrical
- brake parts
- trailer hardware
- locks & pins
- towing & loading
- tie downs
- tools
- chemicals

A-FRAME JACKS (Weld-on or Bolt-on)

TOP WIND

- Extra thick A-frame mounting bracket
- Painted outer and inner tubes
- 3 sizes
- Less wheel or base



PART #	MFG #	CAPACITY	TRAVEL	RETRACTED	EXTENDED	CLEARANCE		
FT510	1550220117	2000#	15"	8.20"	23.20"	12.20"	52.85	E
FT525	1750290317	5000#	15"	10.80"	25.80"	----	45.12	E

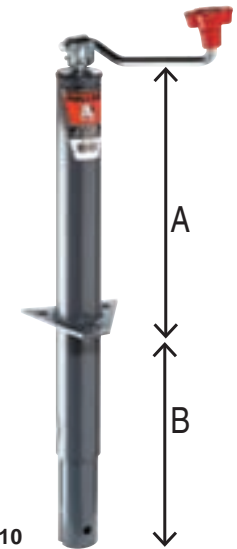

FT510

REPLACEMENT PARTS / ACCESSORIES

DESCRIPTION	PART #	MFG #		
Caster Wheel 2000-5000#	FT554	500245	31.48	E
Replacement Wheel	FT502	6811S00	15.36	E
Replacement Foot Pad	FT560	F2000 010	29.42	E

Item#	Top A	Retracted Length B	Extended Length C
FT510	12.20"	8.20"	23.20"
FT512	10.20"	10.30"	25.30"
FT525	----	10.80"	25.80"

A-FRAME JACKS (Weld-on or Bolt-on)

Easy cranking - 8 turns per inch

SIDE WIND

- Painted outer and inner tubes
- 3 sizes
- Less wheel or base



PART #	MFG #	CAPACITY	TRAVEL	RETRACTED	EXTENDED	CLEARANCE		
FT515	155157	2000#	13"	8.60"	21.50"	13.00"	61.40	E
FT520	1550100317	3000#	13"	7.00"	20.00"	14.50"	61.40	E

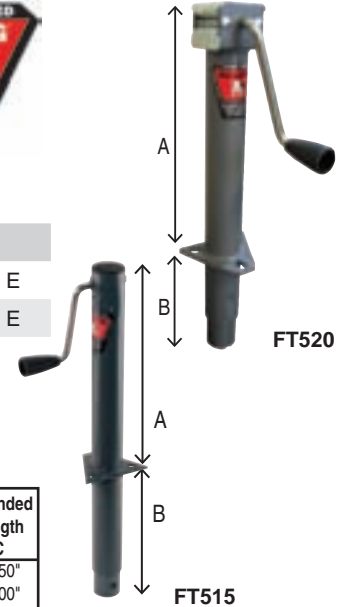

FT520

FT515

REPLACEMENT PARTS / ACCESSORIES

DESCRIPTION	PART #	MFG #		
Caster Wheel 2000-5000#	FT554	500245	31.48	E
Replacement Wheel	FT502	6811S00	15.36	E
Replacement Foot Pad	FT560	F2000 010	29.42	E

Item#	Top A	Retracted Length B	Extended Length C
FT515	13"	8.60"	21.50"
FT520	14.50"	7"	20.00"

TRAILER

WELD-ON RETAINING RING SWIVEL

TOP WIND

- 1/2" diameter plunger pin with base plate
- Includes bracket mount
- Mounting plate and snap ring are sold separately



PART #	MFG #	CAPACITY	TRAVEL	RETRACTED	EXTENDED	CLEARANCE		
FT540	1514010117	2000#	10"	11.00"	21.00"	4.00"	60.48	E
FT542	1514210117	2000#	15"	14.50"	29.50"	10.00"	85.46	E

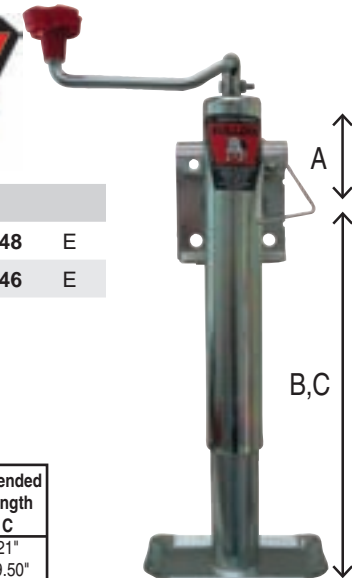

B,C

REPLACEMENT PARTS / ACCESSORIES

DESCRIPTION	PART #	MFG #		
Snap Ring	FT548	P9086-00	1.74	E
Mounting Bracket	FT549	P20520-00	6.16	E
Caster Wheel 2000-5000#	FT554	500245	31.48	E
Replacement Wheel	FT502	6811S00	15.36	E
Replacement Foot Pad	FT560	F2000 010	29.42	E

Item#	Top A	Retracted Length B	Extended Length C
FT540	4"	11"	21"
FT542	10"	14.50"	29.50"

BOLT-ON RETAINING RING SWIVEL

TOP WIND

- Assembled with mounting bracket
- 1/2" diameter plunger pin
- No base
- Fits tongue up to 3" x3"

PART #	MFG #	CAPACITY	TRAVEL	RETRACTED	EXTENDED	CLEARANCE	
FT514	1514430117	2000#	10"	11.00"	21.00"	4.00"	67.84 E

REPLACEMENT PARTS / ACCESSORIES

DESCRIPTION	PART #	MFG #		
Caster Wheel 2000-5000#	FT554	500245	31.48	E
Replacement Wheel	FT502	6811S00	15.36	E
Replacement Foot Pad	FT560	F2000 010	29.42	E

Item#	Top A	Retracted Length B	Extended Length C
FT514	4"	11"	21"

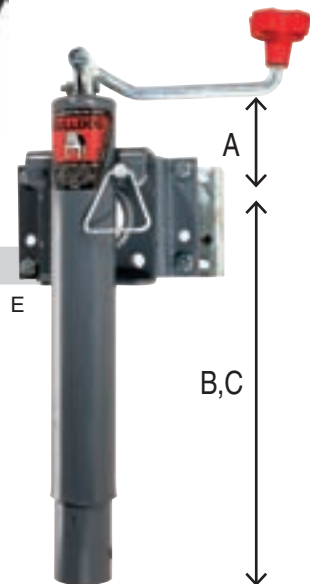

- tires & wheels
- axles, hubs & springs
- tongue accessories
- hitches
- electrical
- brake parts
- trailer hardware
- locks & pins
- towing & loading
- tie downs
- tools
- chemicals

ROUND JACK - TUBULAR SWIVEL (Weld on)

Painted outer tube • Zinc plated inner tube • Easy cranking

TOP WIND

Male mating mount included • 9/16" pin • Includes foot pad

PART #	MFG #	CAPACITY	TRAVEL	RETRACTED	EXTENDED	CLEARANCE	
FT8451	1584510117	2000#	10"	11.00"	21.00"	4.00"	77.88 E

Item#	Top A	Retracted Length B	Extended Length C
FT8451	4"	11"	21"
FT8150	6.40"	11"	21"

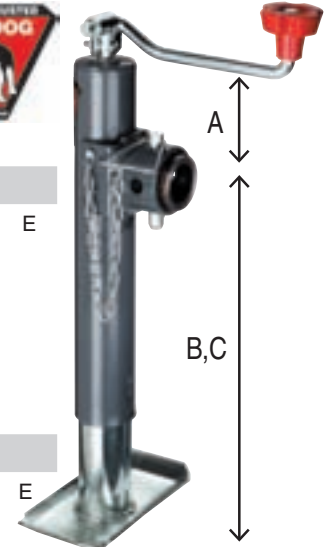

SIDE WIND

Female mating mount included • 5/8" pin • Includes foot pad

PART #	MFG #	CAPACITY	TRAVEL	RETRACTED	EXTENDED	CLEARANCE	
FT8150	198150	7000#	10"	11.00"	21.00"	6.40"	120.84 E

CASTER WHEEL MUST BE PURCHASED SEPARATELY FOR BULLDOG JACKS BULLDOG REPLACEMENT PART KITS - BULK

CASTER WHEEL ASSEMBLY

- 6" x 2" reinforced poly wheel for easy rolling and ground support
- Wheel is replaceable
- Fits 2" jacks
- 1200# load

PART #	MFG #	U/M		
FT555	CE5550301	ea	31.39	E



6" POLY WHEEL KIT

Includes wheel, spacer, bolt, nut

PART #	MFG #	U/M		
FT502	6811S00	ea	15.36	E

BOTTOM SUPPORT PLATE

- For our A-Frame jacks
- A little extra support

PART #	MFG #	U/M		
FT550	SPB500300	ea	3.48	E



FOOT PAD

- 4" x 6"
- 2.1" tall
- Zinc plated

PART #	MFG #	U/M		
FT558	185640301	ea	13.86	E



TRAILER

TONGUE ACCESSORIES

- tires & wheels
- axles, hubs & springs
- tongue accessories
- hitches
- electrical
- brake parts
- trailer hardware
- locks & pins
- towing & loading
- tie downs
- tools
- chemicals



BULLDOG REPLACEMENT PART KITS - CLAM SHELL PACKAGED

Get the attention of your customers with attractive, colorfully packaged Bulldog genuine replacement part kits in clear plastic clam shells. Engineered for maximum strength and durability, a display of these top selling genuine Bulldog replacement parts is a good way to increase overall sales. Consumers know the best way to maintain the integrity of their Bulldog products is to always use genuine replacement parts manufactured by the most trusted name in the industry.



SIDE WIND CRANK KITS

PART #	MFG #	DESCRIPTION	U/M		
FT561	500256	5.80" RADIUS ASSEMBLY AND GEAR KIT 2000#	KIT	20.01	E
FT562	500105	6.50" RADIUS ASSEMBLY W/BLACK KNOB 1000#-5000#	KIT	15.78	E
FT563	500171	8.50" RADIUS ASSEMBLY W/BLACK KNOB 7000#	KIT	21.60	E

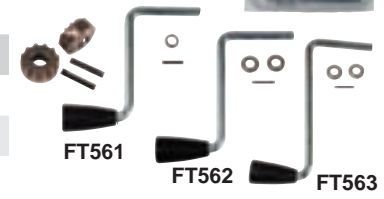

TOP WIND CRANK KIT

PART #	MFG #	DESCRIPTION	U/M		
FT564	500180	6.75" RADIUS ASSEMBLY/RED KNOB 1000#	KIT	13.00	E

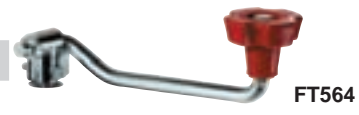

KNOB KITS

PART #	MFG #	DESCRIPTION	U/M		
FT566	500248	BLACK KNOB TEAR DROP 1000#-5000#	KIT	8.10	E
FT567	500246	RED KNOB KIT 2000#-5000#	KIT	8.10	E



PIN KITS

PART #	MFG #	DESCRIPTION	U/M		
FT577	500243	9/16" PULL PIN 3.5" LONG W/CHAIN AND DRIVE SCREW 1000# TOP WIND ONLY	KIT	8.32	E
FT578	500231	5/8" PULL PIN 3.5" LONG W/ CHAIN AND DRIVE SCREW 5000# TOP WIND ONLY	KIT	7.65	E
FT579	500232	5/8" PULL PIN 4.25" LONG W/CHAIN AND COTTER PIN	KIT	9.41	E

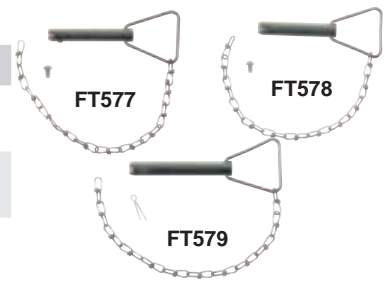

BEARING KITS

PART #	MFG #	DESCRIPTION	U/M		
FT571	500251	BEARING KIT FOR 2000# MODELS	KIT	8.10	E
FT572	500223	THRUST BEARING KIT FOR 5000# CAPACITY MODELS	KIT	11.52	E
FT573	500224	THRUST BEARING KIT FOR 8000# CAPACITY MODELS	KIT	13.65	E



BEARING KITS

PART #	MFG #	DESCRIPTION	U/M		
FT575	500106	SIDE WIND GEAR KIT FOR UP TO AND INCLUDING 5000# MODELS	KIT	11.69	E
FT576	500156	SIDE WIND GEAR KIT FOR 8000# CAPACITY MODELS	KIT	13.68	E



WHEEL KIT

PART #	MFG #	DESCRIPTION	U/M		
FT554	500245	CASTER ASSEMBLY WITH POLY WHEEL 800#	KIT	31.48	E



BASE PLATE KIT

PART #	MFG #	DESCRIPTION	U/M		
FT556	500244	REMOVABLE DISC FOOT W/ PIN 2.1" TALL FITS JACKS W/ 2" TUBE	KIT	17.42	E



TRAILER

BUYERS TOOLBOXES

POLYMER UNDERBODY TOOLBOX

- Height-18" x Depth-18" x Width-36"
- Weight-24lbs
- Constructed of molded high-density ribbed polyethylene
- D-bulb door seal protects from the elements
- Stainless steel recessed locking T-handle 3-point latch w/roller (includes 2 keys)
- Strong double-wall door
- 1/4" stainless steel full width hinge pin

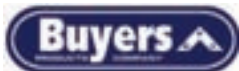

PART #	MFG #		
BY1717	1717105	312.95	G

OPTIONAL MOUNTING BRACKETS

- 15" x 14"
- 11 lbs
- Constructed of heavy duty 2" C-channel A-36 steel
- Black powder-coated for corrosion resistance
- Channel fits inside toolbox ribs
- Pre-drilled 7/16" mounting holes (hardware not included)
- Sold boxed



PART #	MFG #		
BY1701	1701000	63.95	G

POLYMER TRAILER TONGUE BOX

- Height-18" x Depth-19" x Width-36" x 18"
- Weight-21lbs
- Polymer-constructed of molded high density polyethylene
- This toolbox offers an easy way to add secure storage to your trailer

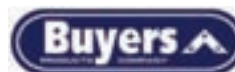

PART #	MFG #		
BY1680	1701680	174.95	E

ALL-PURPOSE POLY CHEST

- Large capacity, low profile chest mounts to floors of pickup beds, trailers, garages, etc.
- Constructed of heavy-duty, impact resistant polyethylene
- Double panel, top-opening lid w/zinc hasp
- Stainless steel hinge
- Built-in carrying handles
- Overlapping lid design seals out weather

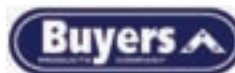

PART #	MFG #		
BY2230	1712230	143.95	G

DUAL POLY STEP • 2 STEPS, BLACK

- Utility step
- Recycled hi-density black polyethylene
- UV stable
- Built-in handle provides easy lifting
- Stackable for storage/shipment
- Non-skid step surface
- Lightweight (14.6 lbs)
- Great for industrial, agricultural and home use
- Wide grip footprint reduces slippage

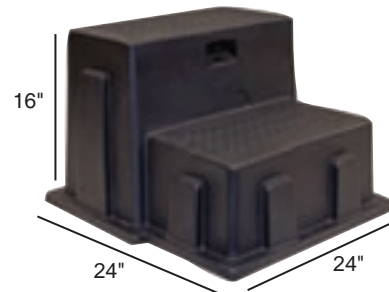
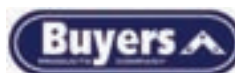

PART #	MFG #		
BY3658	3013658	76.95	G

FOLDING FOOT/GRAB STEP

- Investment cast
- E-coated finish
- 4" W x 2" D
- Sold each (bulk)



PART #	MFG #		
BY2797	B2797BPC	7.95	G

- tires & wheels
- axles, hubs & springs
- tongue accessories
- hitches
- electrical
- brake parts
- trailer hardware
- locks & pins
- towing & loading
- tie downs
- tools
- chemicals

TRAILER

TONGUE ACCESSORIES

BUYERS STRAIGHT TONGUE COUPLERS



PART #	MFG #			BALL SIZE	CHANNEL SIZE	CLASS	GTW	UM
BY91050	0091050	10.95	J	1-7/8"	2"	1	2000#	EA
BY91052	0091052	11.95	G	1-7/8"	2-1/2"	1	2000#	EA
BY91055	0091055	12.95	G	1-7/8"	3"	2	2000#	EA
BY91058	0091058	17.95	G	2"	2"	2	3500#	EA
BY91060	0091060	17.95	G	2"	2-1/2"	2	3500#	EA
BY91065	0091065	17.95	G	2"	3"	2	3500#	EA

- 2", 2 1/2", or 3" channel
- Can be bolted or welded to trailer frame
- Recreational or utility use
- Pad lock hole provided for trailer security



FULTON STRAIGHT TONGUE COUPLERS



PART #	MFG #			BALL SIZE	CHANNEL SIZE	CLASS	GTW	COLOR	UM
FT310	11200 0201*	22.33	E	1-7/8"	2"	I	2000#	ZINC	EA
FT210	11200-0217	12.95	E	1-7/8"	2"	I	2000#	PRIMED	EA
FT311	11250-0201*	22.33	E	1-7/8"	2-1/2"	I	2000#	ZINC	EA
FT211	11250-0217	12.95	E	1-7/8"	2-1/2"	I	2000#	PRIMED	EA
FT312	11300-0201*	22.33	E	1-7/8"	3"	I	2000#	ZINC	EA
FT212	11300-0217*	12.95	E	1-7/8"	3"	I	2000#	PRIMED	EA
FT313	22200 0201*	25.31	E	2"	2"	II	3500#	ZINC	EA
FT213	22200-0217*	17.28	E	2"	2"	II	3500#	PRIMED	EA
FT315	22250-0101	25.31	E	2"	2-1/2"	II	3500#	ZINC	EA
FT215	22250-0217*	17.28	E	2"	2-1/2"	II	3500#	PRIMED	EA
FT314	22300 0101*	25.31	E	2"	3"	II	3500#	ZINC	EA
FT214	22300-0217*	17.28	E	2"	3"	II	3500#	PRIMED	EA
FT316	34300-0301	30.47	E	2"	3"	III	5000#	ZINC	EA
FT216	34300-0217*	29.34	E	2"	3"	III	5000#	PRIMED	EA

- The most popular latching mechanism ever designed is now available in a complete line of FAS-LOC couplers from Fulton
- Available in 1-7/8" and 2". Class I, II and III straight tongue
- Proven Fulton FAS-LOC locking lever hooks up quickly and easily to tow vehicle
- Heavy duty safety latch designed to prevent accidental uncoupling
- Padlock hole provided for trailer security



BUYERS HEAVY DUTY STRAIGHT TONGUE COUPLERS

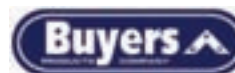

PART #	MFG #			BALL SIZE	CHANNEL SIZE	CLASS	GTW	UM
BY91560	0091560	110.95	G	2"	3"	IV	10,000#	EA
BY91562	0091562	113.95	G	2"	3"	IV	15,000#	EA

- 2 sizes
- Automatic engage latch
- Easy one hand operation
- 3" channel welded to coupler
- Cast steel coupler
- Zinc and clear chromatic finish



TRAILER

- tires & wheels
- axles, hubs & springs
- tongue accessories
- hitches
- electrical
- brake parts
- trailer hardware
- locks & pins
- towing & loading
- tie downs
- tools
- chemicals

BUYERS A-FRAME COUPLERS

- 2 sizes
- 50° frame design
- Pre-drilled for round jack mounting



PART #	MFG #			BALL SIZE	FRAME DEGREE	CLASS	GTW	UM
BY91091	0091091	23.95	G	2"	50	III	5000#	EA
BY91097	0091097	34.95	G	2-5/16"	50	IV	10,000#	EA

FULTON A-FRAME COUPLERS

- Weld on
- Bulk
- Fits 50° frames
- Ductile iron ball clamp
- Stainless steel spring & pivot pin
- Easy latch mechanism
- Positive open latch feature



PART #	MFG #			BALL SIZE	FRAME DEGREE	CLASS	GTW	UM
FT252	E33305-0303	18.85	E	2"	50	III	5000#	EA
FT254	44305R0317	56.47	E	2-5/16"	50	IV	10,000#	EA

BUYERS A-FRAME CAST COUPLERS

- Heavy-duty cast steel coupler, with steel a-frame
- Auto-engage latch
- Easy one-hand operation
- Durable, black powdercoat finish
- Can be pinned open for ease of coupling
- 50° a-frame
- Round jack mount
- 18" overall length



PART #	MFG #			BALL SIZE	FRAME DEGREE	CLASS	GTW	UM
BY91595	0091595	148.95	B	2-5/16"	50	N/A	15,000#	EA

- tires & wheels
- axles, hubs & springs
- tongue accessories
- hitches
- electrical
- brake parts
- trailer hardware
- locks & pins
- towing & loading
- tie downs
- tools
- chemicals

TRAILER

TONGUE ACCESSORIES

BUYERS ADJUSTABLE CHANNEL MOUNT ONLY

- 3 position / 5 position
- To be used with **BY91005** cast coupler

PART #	MFG #			POSITIONS	WELDED GUSSETS	UM
BY8978	B8978	15.95	G	3	NO	EA
BY8979	B8979	26.95	G	5	YES	EA

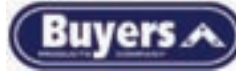

BUYERS ADJUSTABLE COUPLER REPAIR KIT

- Adjustable repair kit for coupler # **BY91015** (above)
- Sold separately

PART #	MFG #			SIZE	GTW	UM
BY91015	0091015	23.95	G	1-7/8"-2"	7000#	EA



COUPLER REPAIR KITS

- All the necessary parts are included in this repair kit
- Instead of replacing the entire trailer coupler, this kit will allow you to rebuild your old coupler

PART #	MFG #			SIZE	UM
CRK5150	5150-94	12.95	G	1-7/8"	EA
CRK5151	5151-94	13.45	G	2"	EA



FULTON HANDI GRIP COUPLER HANDLE

- Display packaged each
- Allows for easy trailer positioning
- Fits all 1-7/8" & 2" couplers
- Easy bolt on installation
- Non-corrosive finish, comfort grip handle

PART #	MFG #			UM
FT200	CH0701	13.53	E	EA



FULTON FOLD-AWAY BOLT-ON HINGE KITS

- Converts standard trailer tongues into fold-away configures while preserving the existing coupler
- Delivers strength at the pivot point with precisely machined heavy duty hinges made from die cast steel
- Easy to install bolt-on application with complete instruction manual
- Mount Fold-Away products to trailer tongues made only of steel
- Includes all mounting hardware

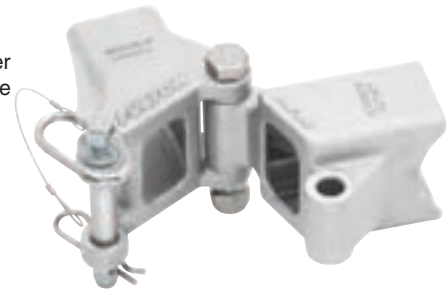

PART #	MFG #			DESCRIPTION
444376	HDPB230101	104.90	E	FULTON FOLD-AWAY BOLT-ON HINGE KIT, 2" X 3" TRAILER BEAM, ZINC FINISH, RATING 5,000 LBS.
444377	HDPB330101	120.85	E	FULTON FOLD-AWAY BOLT-ON HINGE KIT, 3" X 3" TRAILER BEAM, ZINC FINISH, RATING 5,000 LBS.
444378	HDPB340101	139.83	E	FULTON FOLD-AWAY BOLT-ON HINGE KIT, 3" X 4" TRAILER BEAM, ZINC FINISH, RATING 7,500 LBS.
444379	HDPB350101	149.63	E	FULTON FOLD-AWAY BOLT-ON HINGE KIT, 3" X 5" TRAILER BEAM, ZINC FINISH, RATING 9,000 LBS.

- tires & wheels
- axles, hubs & springs
- tongue accessories
- hitches
- electrical
- brake parts
- trailer hardware
- locks & pins
- towing & loading
- tie downs
- tools
- chemicals

HITCHES



HITCHES

TOW READY BUMPER GUARDS

Protects vehicle from coupler impact while backing up



PART #	MFG #	DESCRIPTION	U/M		
444159	80400	Black Powder Coat	EA	49.30	B
444160	80470	Diamond Plate	EA	53.68	B

WRENCH FOR HITCH BALLS

Boxed ends, 1-1/8" & 1-1/2". Zinc finish.



444161	74342	16.90	B
--------	-------	-------	---

TRIMAX TOW BALLS

Weight Rating 8,000 lbs



PART #	MFG #	DESCRIPTION	U/M		
348047	TBC2	2" Tow Ball Chrome	EA	12.99	L
348048	TBC2516	2-5/16" Tow Ball Chrome	EA	14.99	L
348049	TDBC22516	2" & 2-5/16" Double Tow Ball Chrome	EA	27.99	G
348050	TBSX2	2" Tow Ball Stainless Steel	EA	44.99	G
348051	TBSX2516	2-5/16" Tow Ball Stainless Steel	EA	49.99	G
348052	TDBSX22516	2" & 2-5/16" Double Tow Ball Stainless Steel	EA	79.99	TBA



SWIFT HITCH™ CAMERA

Hooking up your trailer is now a one person operation!
Perfect for marine, motorcycle, RV, snowmobile, ATV, camper, farm & fleet, or any trailer application

- Portable wireless camera & monitor
- Full color LCD 960 x 240 monitor
- Works day or night with infrared technology
- Excellent resolution
- Reverse option imaging for easier backing
- Magnetized camera mount
- Includes 12 volt charger and rechargeable battery
- Optic range of camera is 300 ft.
- Includes carrying cases & spare battery
- No wiring necessary. Ready to use.
- One hand operation
- Range from camera to monitor is up to 50 ft.



HL8105 SH01 299.95 L

PARTS FOR TRAILER BALLS

Nut and washer kits packaged shank reducers. Sold bulk.

PART #	MFG #	DESCRIPTION	U/M		
BY2090	1802090	NUT & WASHER 3/4"	EA	2.95	J
BY2091	1802091	NUT & WASHER 1"	EA	2.95	H
BY2092	1802092	NUT & WASHER 1-1/4"	EA	2.95	G
BY2097	1802097	BALL SHANK REDUCER 1" TO 3/4"	EA	2.95	G



HITCH BALL COVERS

Fits 1-7/8"-2" trailer balls with an adjustable inside spring to stay snug.

PART #	COLOR	U/M		
571761	BLACK	EA	0.30	L



- tires & wheels
- axles, hubs & springs
- tongue accessories
- hitches**
- electrical
- brake parts
- trailer hardware
- locks & pins
- towing & loading
- tie downs
- tools
- chemicals

HITCHES

TOW READY HITCH BALLS

Chrome external thread balls fit right every time and are selected to match:
Size of coupler, Gross trailer weight, Thickness of platform, Hole size.



BALL DIA. (A)	SHANK DIA. (B)	SHANK LENGTH (C)	DRAWBAR THICKNESS RANGE	MAX GROSS TRAILER WGT. (GTW) #	PKG/ BULK	ZINC PART #	CHROME PART #	STAINLESS PART #
1-7/8"	3/4"	1-1/2"	3/8"-5/8"	2000#	BULK	444126 8.08 B	DT5012 8.58 G	----
1-7/8"	3/4"	1-1/2"	3/8"-5/8"	2000#	PKG	444137 9.62 B	DT3572 10.15 B	----
1-7/8"	3/4"	2-3/8"	3/8"-1-3/8"	2000#	BULK	444127 10.15 B	DT5022 10.67 G	----
1-7/8"	3/4"	2-3/8"	3/8"-1-3/8"	2000#	PKG	----	DT3574 12.21 G	----
1-7/8"	3/4"	3-3/8"	3/8"-1-3/8"	2000#	BULK	----	DT4102 14.32 G	----
1-7/8"	1"	2-1/8"	3/8"-3/4"	2000#	BULK	444128 9.42 B	DT5032 9.97 G	----
1-7/8"	1"	2-1/8"	3/8"-3/4"	2000#	PKG	444138 10.98 B	DT3584 11.47 G	444149 37.17 B
1-7/8"	1"	3-3/8"	3/8"-2-1/8"	2000#	BULK	444129 10.05 B	DT4122 10.55 G	----
2"	3/4"	1-1/2"	3/8"-5/8"	3500#	BULK	444130 8.08 B	DT5062 8.58 G	----
2"	3/4"	1-1/2"	3/8"-5/8"	3500#	PKG	444139 9.62 B	DT3576 10.15 G	----
2"	3/4"	2-3/8"	3/8"-1-3/8"	3500#	BULK	444131 10.15 B	DT5072 10.67 G	----
2"	3/4"	3-3/8"	3/8"-2-1/8"	3500#	BULK	----	DT4112 14.50 G	----
2"	1"	2-1/8"	3/8"-3/4"	6000#	PKG	----	----	444150 41.67 B
2"	1"	2-1/8"	3/8"-3/4"	7500#	BULK	444132 9.89 B	DT5082 10.41 G	----
2"	1"	2-1/8"	3/8"-3/4"	7500#	PKG	444140 11.46 B	444079 11.97 G	----
2"	1"	3-3/8"	3/8"-2-1/8"	7500#	BULK	444133 11.21 B	444080 11.72 G	----
2"	1-1/4"	2-3/4"	3/8"-1"	8000#	BULK	444134 16.67 B	----	----
2"	1-1/4"	2-3/4"	3/8"-1"	8000#	PKG	----	444146 18.95 B	----
2-5/16"	1"	2-1/8"	3/8"-3/4"	6000#	PKG	----	----	444151 47.46 B
2-5/16"	1"	2-1/8"	3/8"-3/4"	7500#	BULK	444135 13.16 B	DT5042 13.68 G	----
2-5/16"	1"	2-1/8"	3/8"-3/4"	7500#	PKG	444141 14.59 B	444147 15.90 B	----
2-5/16"	1-1/4"	2-3/4"	3/8"-1"	12,000#	BULK	444136 16.61 B	DT5092 17.13 G	----
2-5/16"	1-1/4"	2-3/4"	3/8"-1"	12,000#	PKG	444142 19.10 B	444148 19.61 B	----
2-5/16"	1-1/4"	2-3/4"	3/8"-1"	14,000#	BULK	----	444143 22.51 B	----
2-5/16"	1-1/4"	2-3/4"	3/8"-1"	20,000#	BULK	----	444144 24.75 B	----
50MM	3/4"	1-1/2"	3/8"-5/8"	3500#	BULK	----	444145 10.40 B	----

BUYERS TRAILER HITCH BALLS

Buyers offers a complete line of the most popular hitch balls. Available in stainless steel, chrome, or plain finish. These hitch balls combine rugged performance with good looks.

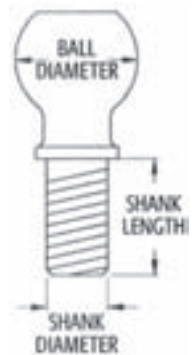

PART #	MFG #	BALL DIA.	SHANK DIA.	SHANK LENGTH	MAX GTW	COLOR	PKG/ BULK	
BY2015	1802015	1-7/8"	3/4"	2-1/8"	3500#	CHROME	PKG	7.95 G
BY2020	1802020	1-7/8"	1"	2-1/8"	5000#	CHROME	PKG	7.95 H
BY2010	1802010	2"	3/4"	2-1/8"	3500#	CHROME	PKG	7.95 G
BY2005	1802005	2"	1"	2-1/8"	5000#	CHROME	PKG	8.95 G
BY2007	1802007	2"	1"	2-3/4"	10,000#	CHROME	PKG	9.95 H
BY2026	1802026	2-5/16"	1"	2-1/8"	7500#	CHROME	PKG	10.95 G
BY2027	1802027	2-5/16"	1"	2-3/4"	10,000#	CHROME	PKG	12.95 G
BY2025	1802025	2-5/16"	1-1/4"	2-3/4"	10,000#	CHROME	PKG	13.95 G
BY2140	1802140	2"	1"	2-1/8"+1" RISE	5000#	CHROME	BULK	10.95 H
BY2144	1802144	2"	1"	2-1/8"+2" RISE	5000#	CHROME	BULK	13.95 H
BY2173	1802173	2-5/16"	1-1/4"	2-1/2"+1" RISE	7000#	CHROME	BULK	16.95 G
BY2175	1802175	2-5/16"	1-1/4"	2-1/2"+2" RISE	7000#	CHROME	BULK	17.95 G
BY2050	1802050	2-5/16"	1-1/4"	2-3/4"	30,000#	PLAIN	BULK	25.95 G
BY2056	1802056	2-5/16"	1-1/2"	2-3/4"+1" RISE	30,000#	PLAIN	BULK	31.95 G
BY2061	1802061	2-5/16"	1-1/2"	2-3/4"+2" RISE	30,000#	PLAIN	BULK	33.95 G



TOWING BALLS CHROME FINISH

TRAILER

BUYERS SAFETY CHAINS

Zinc plated. With quick link connectors all except **BY3835** are display packaged. **BY3835** has a slip hook, **BY11275** has a clevis style slip hook.

PART #	MFG #	CLASS	BREAKING STRENGTH	SIZE	U/M		
BY11215	11215	II	5000#	9/32"X48"	EA	7.95	J
BY3254	B93254SC	II	5000#	9/32"X54"	EA	8.95	G
BY11220	11220	II	5000#	9/32"X72"	EA	11.95	J
BY3835	B03835SC	IV	10,000#	3/8"X35"	EA	12.95	G
BY11275	11275	IV	15,000#	3/8"X35"	EA	12.95	J

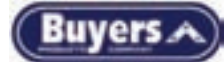

BY3835



BY3254

BUYERS QUICK LINK CONNECTOR

Zinc plated. Ideal for connecting chains, cables, wires and ropes.

PART #	MFG #	SIZE	U/M		
BY0038	7350038	3/8"	EA	4.95	G

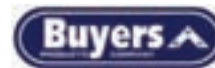

SMITH SAFETY CHAINS

Display packaged. Trailer safety chains with heat treated S-hooks. Zinc plated for corrosion resistance. Does not come with quick connectors.

PART #	MFG #	CLASS	BREAKING STRENGTH	SIZE	U/M		
CS16651	16651A	I	2000#	3/16"	PR	17.85	G
CS16661	16661A	II	3500#	5/0	PR	19.65	G
CS16671	16671A	III	5000#	1/4"	PR	21.95	G
CS16681	16681A	IV	7600#	8/0	PR	30.95	G



SMITH SAFETY HOOKS

Sold each (bulk). S-Hooks for trailer safety chain. Zinc.

PART #	MFG #	BREAKING STRENGTH	STYLE	U/M		
CS16640	16640	2000#	"S" HOOK	EA	1.20	L
CS16642	16642	5000#	"S" HOOK	EA	1.75	L
CS16795	16795A	7500#	SNAP HOOK	EA	7.95	G



CS16640



CS16795

SMITH "S" HOOK KEEPERS

Fastens over S-hook after chain is attached to the vehicle. Prevents chain from bouncing off. Comes packaged as a pair.

PART #	MFG #	U/M		
CS16691	16691A	PR	5.65	G



- tires & wheels
- axles, hubs & springs
- tongue accessories
- hitches**
- electrical
- brake parts
- trailer hardware
- locks & pins
- towing & loading
- tie downs
- tools
- chemicals

TRAILER

HITCHES

- tires & wheels
- axles, hubs & springs
- tongue accessories
- hitches**
- electrical
- brake parts
- trailer hardware
- locks & pins
- towing & loading
- tie downs
- tools
- chemicals

TIE DOWN SAFETY CHAINS

Zinc plated trailer safety chains are skin packed with S-hooks.

PART #	MFG #	CLASS	BREAKING STRENGTH	SIZE	U/M		
LR81202	81202	II	3500#	3/16"X31"	PR	15.75	G
LR81203	81203	III	5000#	1/4"X31"	PR	20.05	G
LR81204	81204	IV	7500#	5/16"X40-3/4"	PR	38.45	G
LR81205	81205	II	3500#	3/16"X36"	EA	14.08	G



TIE DOWN HITCH CABLES

Replace your noisy chains with self-coiling hitch cables. Available plain or jacketed. Both use durable galvanized aircraft cable construction. Each pair is skin packaged.

PART #	MFG #	CLASS	BREAKING STRENGTH	SIZE	FINISH	U/M		
LR59533	59533	I	2000#	36"	BLACK VINYL JACKETED	PR	19.46	G
LR59535	59535	II	3500#	36"	GALVANIZED	PR	19.46	G
LR59537	59537	II	3500#	36"	BLACK VINYL JACKETED	PR	21.58	G
LR59539	59539	III	5000#	36"	GALVANIZED	PR	25.44	G
LR59541	59541	III	5000#	36"	BLACK VINYL JACKETED	PR	27.93	G
LR59543	59543	IV	7000#	36"	GALVANIZED	PR	26.04	G
LR59545	59545	IV	7000#	36"	BLACK VINYL JACKETED	PR	27.59	G
LR59548*	59548	IV	7000#	36"	BLACK VINYL JACKETED	PR	29.82	G

LR59548* COMES WITH SAFETY LATCH HOOK

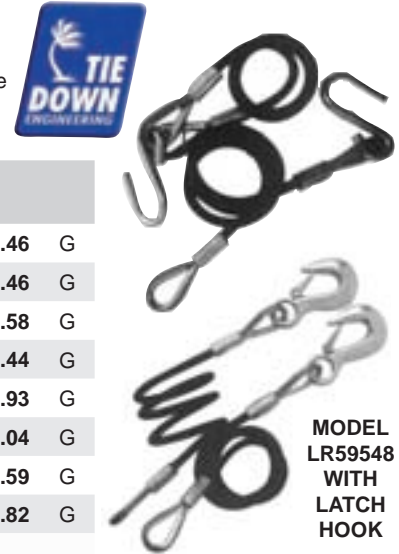

MODEL LR59548 WITH LATCH HOOK

TIE DOWN THREADED LINKS

Quick links ideal for trailer chains. Zinc plated for rust prevention.

PART #	MFG #	SIZE	U/M	PART #	
LR50646	50646	3/16"	2 PER PKG	3.90	G
LR50647	50647	1/4"	2 PER PKG	4.62	G
LR50648	50648	5/16"	1 PER PKG	3.15	G
LR50649	50649	3/8"	1 PER PKG	4.57	G



TIE DOWN LATCH HOOK

Zinc plated latch hook skin packaged each.

PART #	MFG #	BREAKING STRENGTH	U/M		
LR50640	50640	7000#	EA	5.55	G
LR50645	50645	7500#	EA	10.44	G
LR50641	50641	12000#	EA	11.30	G



TIE DOWN "S" HOOK SAFETY CHAIN KEEPER

These patented safety chain keepers attach easily to the "s" hooks to keep your chains secure to the vehicle. Retail packaged 2 per package.

PART #	MFG #	U/M		
LR81255	81255	PR	6.01	G



TRAILER

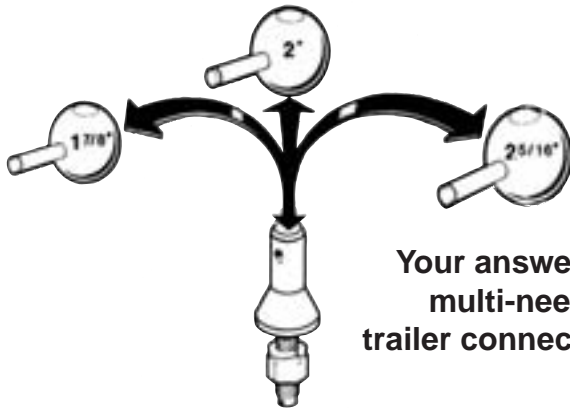

Your answer to multi-need trailer connections.

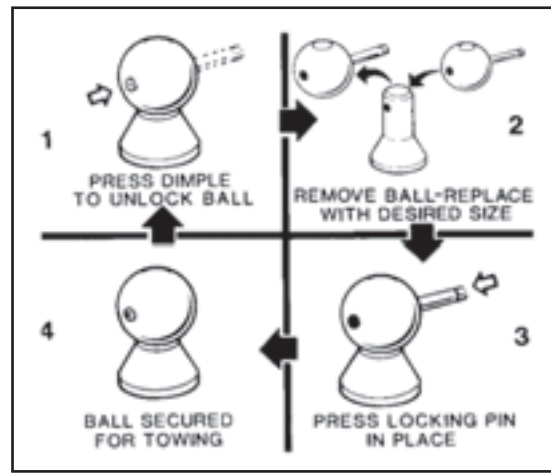

No more wrenches - three interchangeable balls (1-7/8", 2" and 2-5/16") fit on the 1" shank. The 1-7/8" and 2" balls work great on the 3/4" shank. SAE-I684-E Approved - V-5 Rated. All units shrink packaged for display.

CHROME SETS

PART #	MFG #	BALL SIZE	SHANK SIZE	SHANK LENGTH	U/M		
CB4800	800B	1-7/8", 2"	3/4"	REGULAR	SET	39.95	B
CB4900	900B	1-7/8", 2", 2-5/16"	1"	REGULAR	SET	61.95	B
CB4901	901B	1-7/8", 2"	1"	REGULAR	SET	43.95	B
CB4904	904B	2", 2-5/16"	1"	REGULAR	SET	49.95	B
CB4105	105LB	1-7/8", 2"	1"	LONG	SET	49.95	B

SOLD AS COMPLETE KITS

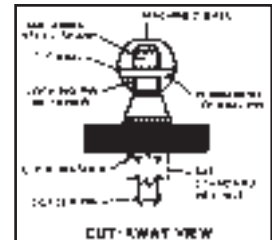

STAINLESS STEEL SETS

PART #	MFG #	BALL SIZE	SHANK SIZE	SHANK LENGTH	U/M		
CB4802	802B	1-7/8", 2"	3/4"	REGULAR	SET	76.95	B
CB4903	903B	1-7/8", 2"	1"	REGULAR	SET	75.95	B
CB4902	902B	1-7/8", 2", 2-5/16"	1"	REGULAR	SET	111.95	B
CB4906	906B	2", 2-5/16"	1"	REGULAR	SET	93.95	B



WINCH MOUNTING PLATE

Our front mounted receivers are rated for 9,000 lbs. line pull. This makes them ideal for use with winches. We offer a winch adapter that connects the winch to the receiver. They accept most models of Superwinch, Ramsey and Warn. Will not fit with S4500 Superwinch.



PART #	MFG #	DESCRIPTION	U/M		
444115	6495	Front Mount Receiver Accessory, Winch Mounting Plate	EA	161.77	B
444116	6980	Handle Kit for 444115 Winch Mounting Plate	EA	200.46	B



- tires & wheels
- axles, hubs & springs
- tongue accessories
- hitches**
- electrical
- brake parts
- trailer hardware
- locks & pins
- towing & loading
- tie downs
- tools
- chemicals

TRAILER

HITCHES

- tires & wheels
- axles, hubs & springs
- tongue accessories
- hitches**
- electrical
- brake parts
- trailer hardware
- locks & pins
- towing & loading
- tie downs
- tools
- chemicals

BALL ONLY

PART #	MFG #	SIZE	COLOR	U/M		
CB4300	300B	1-7/8"	CHROME	EA	12.95	B
CB4301	301B	1-7/8"	STAINLESS	EA	23.95	B
CB4400	400B	2"	CHROME	EA	13.95	B
CB4401	401B	2"	STAINLESS	EA	27.95	B
CB4600*	600B	2-5/16"	CHROME	EA	17.95	B
CB4601*	601B	2-5/16"	STAINLESS	EA	38.95	B

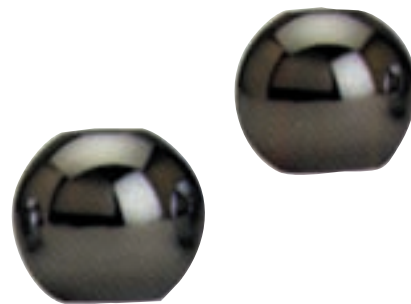

*WILL NOT WORK ON THE 3/4" SHANK

SHANK ONLY

PART #	MFG #	SIZE	LENGTH	U/M		
CB4101	101B	3/4"	LONG	EA	15.95	B
CB4102	102B	1"	REGULAR	EA	18.85	B
CB4104	105B	1"	LONG	EA	24.95	B



SHANK COVERS

PART #	MFG #	COLOR	U/M		
CB4002	005B	BLACK	EA	2.10	B

SHANK STORAGE

PART #	MFG #	DESCRIPTION	U/M		
CB4004	004B	3 BALL STORAGE BOX W/ COVER	EA	12.35	B



INTERCHANGEABLE HITCH BALL SYSTEMS

Designed to accommodate towing multiple trailers with ease, Tow Ready Interchangeable Hitch Ball System allows you to change hitch ball sizes in seconds without any tools.

- Innovative quick release changes balls in seconds
- Rated capacities up to 5,000 lbs.
- Durable heat treated shank
- New positive latch design
- No special tools required



PART #	MFG #	DESCRIPTION	FINISH		
444117	63801	3/4" Shank, 1-7/8" & 2" Balls, 5,000 lbs. Rating	Chrome	49.96	B
444118	63802	1" Shank, 1-7/8" & 2" Balls, 8,000 lbs. Rating	Chrome	52.95	B
444119	63804	1" Shank, 2" & 2-5/16" Balls, 8,000 lbs. Rating	Chrome	55.93	B
444120	63803	1" Shank, 1-7/8", 2" & 2-5/16" Balls, 8,000 lbs. Rating	Chrome	67.12	B

REPLACEMENT INTERCHANGEABLE HITCH BALLS

PART #	MFG #	DESCRIPTION	FINISH		
444121	63805	1-7/8" Replacement Ball for 3/4" & 1" Shanks	Chrome	11.93	B
444122	63806	2" Replacement Ball for 3/4" & 1" Shanks	Chrome	14.91	B
444123	63807	2-5/16" Replacement Ball for 1" Shank	Chrome	17.90	B
444124	63808	3/4" Replacement Shank	Chrome	34.31	B
444125	63809	1" Replacement Shank	Chrome	37.28	B

DRAWBAR KITS

- Boxed includes drawbar, pin and clip
- Black powder coat finish over A-Coat
- Fits 1-1/4" square receiver tube opening



PART #	MFG #	DESCRIPTION	WEIGHT CARRYING		
444152	3590	Class I 1-1/4" Drawbar Kit, Drawbar (2000 lbs. w/3/4" Ball Hole 6-5/8" Length x 5/8" Rise), Pin and Clip, Black	200/2,000 lbs. (TW/GTW)	27.97	B
444153	3591	Class I 1-1/4" Drawbar Kit, Drawbar (2000 lbs. w/3/4" Ball Hole 9-3/4" Length x 5/8" Rise), Pin and Clip, Black	200/2,000 lbs. (TW/GTW)	27.97	B
444154	3592	Class I 1-1/4" Drawbar Kit, Drawbar (2000 lbs. w/3/4" Ball Hole 9-3/4" Length x 2-1/8" Rise x 2-3/4" Drop), Pin and Clip, Black	200/2,000 lbs. (TW/GTW)	27.97	B
444155	3593	Class I 1-1/4" Drawbar Kit, Drawbar (2000 lbs. w/3/4" Ball Hole 6-5/8" Length x 2-1/8" Rise x 2-3/4" Drop), Pin and Clip, Black	200/2,000 lbs. (TW/GTW)	27.97	B
444156	3594	Class I 1-1/4" Drawbar Kit, Drawbar (2000 lbs. w/3/4" Ball Hole 10" Length x 4" Rise), Pin and Clip, Black	200/2,000 lbs. (TW/GTW)	27.97	B
444157	36063	Class II Drawbar Kit, Drawbar (3500 lbs. w/3/4" Ball Hole 11-3/4" Length x 3-1/8" Rise), Pin and Clip, Black	300/3,500 lbs. (TW/GTW)	30.95	B
444158	36078	Class II Drawbar Kit, Drawbar (3500 lbs. w/3/4" Ball Hole 7-3/8" Length x 4-3/4" Drop), Pin and Clip, Black	300/3,500 lbs. (TW/GTW)	57.53	B

ADJUSTABLE HITCHES

- Flip ball mount for added rise
- Easily remove and flip double ball assembly to change ball size
- Ball mount key locks in place for added security

PART #	MFG #	DESCRIPTION		
348044	TRZ6PB	Deluxe 6" Powder Coat Black Drop Hitch	189.95	L
348045	TRZ8PB	Deluxe 6" Powder Coat Black Drop Hitch	189.95	L
348046	TRAZ12PB	Deluxe 12" Powder Coat Black Drop Hitch	199.95	L



- tires & wheels
- axles, hubs & springs
- tongue accessories
- hitches**
- electrical
- brake parts
- trailer hardware
- locks & pins
- towing & loading
- tie downs
- tools
- chemicals

TRAILER

BALL MOUNTS

- New quick loading ball mounts feature a revolutionary angle cut design, providing a quick easy connection to the receiver
- 2" x 2" shank
- Black powder coated finish
- Angle cut design



SELECTING THE PROPER BALL MOUNT: BALL MOUNT MEASUREMENTS

DRAWBAR TYPES



PART #	MFG #	MAX GTW/TW	BALL HOLE SIZE	A LENGTH	B RISE	C DROP	STYLE	INCLUDE PIN?	U/M		
DT40342	40342-006	6000/600	1"	8-1/2"	3/4"	2"	2	NO	EA	17.73	E
DT40343	40343006	6000/600	1"	10-1/2"	3/4"	2"	2	NO	EA	20.26	E
DT40443*	40443	6000/600	1"	10-1/2"	3/4"	2"	2	YES	EA	46.29	E
DT40344	40344-006	6000/600	1"	9"	2-3/4"	4"	3	NO	EA	20.75	E
DT40345	40345-006	6000/600	1"	11"	2-3/4"	4"	3	NO	EA	22.34	E
DT40346	40346002	6000/600	1"	9-1/2"	4-3/4"	6"	3	NO	EA	52.65	E
DT40446*	40446	6000/600	1"	9-1/2"	4-3/4"	6"	3	YES	EA	28.41	E
DT36051*	36051	3500/300	3/4"	7"	5/8"	1-1/4"	1	YES	EA	30.95	G
DT36053*	36053	3500/300	3/4"	9-3/4"	5/8"	1-1/4"	1	YES	EA	30.95	G
DT36061*	36061	3500/300	3/4"	9-3/4"	3-1/8"	3-1/2"	2	YES	EA	30.95	G
DT36065*	36065	3500/300	3/4"	10"	5"	5-1/2"	2	YES	EA	30.95	G
DT36071*	36071	3500/300	3/4"	7-3/16"	2-5/8"	3-1/4"	3	YES	EA	30.95	G

*COMES IN BOX WITH PIN

TRAILER

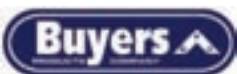

TOWING BALL MOUNT
2" or 4" DROP

HEAVY DUTY TOWING BALL MOUNT - 2" SHANK

- Single piece solid forged shank
- Fits all 2" receiver tubes
- Black powder coated for corrosion resistance
- Tongue accepts 1" & 1-1/4" diameter shank towing balls

DESCRIPTION	M. V. L.	MAX DROP	DIAMETER	M.G.T.W.	PART #	
H/D Ball Mount	2,000#	2" Drop	1" Hole	20,000#	BY3050	39.95 G
H/D Ball Mount	2,000#	2" Drop	1-1/4" Hole	20,000#	BY3051	41.95 G
H/D Ball Mount	2,000#	4" Drop	1" Hole	20,000#	BY3055	52.95 G
H/D Ball Mount	2,000#	4" Drop	1-1/4" Hole	20,000#	BY3056	52.95 G
H/D Ball Mount	1,700#	6" Drop	1" Hole	17,000#	BY3058	55.95 G
H/D Ball Mount	1,700#	6" Drop	1-1/4" Hole	17,000#	BY3059	51.95 G

BALL MOUNT - 2 1/2" SHANK

- Fits 2" receiver tubes
- 2 piece welded steel construction
- Black powder coated finish
- Tongue accepts 1-1/4" diameter shank towing balls

CAPACITY
12,000 lbs. M.G.T.W
1,200 lbs. Maximum Vertical Load



DESCRIPTION	PART #	
High-Low Ball Mount, 10" Length/5" Drop	BY3410	63.95 G



M. V. L. = MAXIMUM VERTICAL LOAD M. G. T. W. = MAXIMUM GROSS TOWING WEIGHT

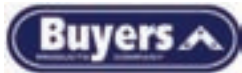

- tires & wheels
- axles, hubs & springs
- tongue accessories
- hitches**
- electrical
- brake parts
- trailer hardware
- locks & pins
- towing & loading
- tie downs
- tools
- chemicals



BY3006



BY3005

BALL MOUNT - 2" SHANK

- Straight, high-low and deep drop tube style ball mounts
- Fits 2" receiver tubes
- Two piece welded steel construction
- Tongue accepts 1" diameter shank towing balls
- Available in stainless steel, chrome plated or black powder coat finish
- 6000 M.G.T.W., 600 lbs Maximum Vertical Load

DESCRIPTION	LENGTH	MAX DROP	PART #		
Straight Ball Mount	8"	2"	BY3005	15.95	G
Straight Ball Mount Chrome Plated	8"	2"	BY3006	20.95	G
High-Low Ball Mount	8"	4"	BY3010	19.95	H
High-Low Ball Mount Chrome Plated	8"	4"	BY3011	24.95	H
High-Low Ball Mount	10"	4"	BY3013	17.95	G
Deep Drop Ball Mount	10"	6"	BY3015	26.95	G
Deep Drop Ball Mount Chrome Plated	10"	6"	BY3016	32.95	G
Deep Drop Ball Mount	10"	8"	BY3017	28.95	G
Deep Drop Ball Mount Solid Shank	10.28"	10 1/4"	BY3019 *	55.95	G

- * Note: M.V.L. 350#
- M.G.T.W. 5,000#

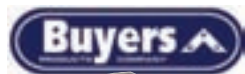

BY3110

BALL MOUNT - 1-1/4" SHANK

- Fits 1-1/4" receiver tubes
- Solid steel construction
- Black powder coat finish for durability & corrosion resistance
- Tongue accepts 3/4" diameter shank towing balls
- 3500 M.G.T.W., 300 lbs Maximum Vertical Load

LENGTH	MAX DROP	PART #		
9"	1 1/4"	BY3100	19.95	G
7"	4"	BY3110	20.95	G



444076

444073

444074

444075

444077

BALL MOUNT - 2-1/2" SQUARE SHANK FOR USE WITH TITAN HITCHES

- 2-1/2" square design for use with Titan Hitches
- Ideal for marine, agricultural and recreational use
- Black powder coat finish

RISE	DROP	LENGTH	DIAMETER	M.G.T.W.	PART #		
1-1/2"	3" Drop	9-3/4"	1-1/4" Hole	14,000#	444073	82.99	G
3-1/2"	5" Drop	10"	1-1/4" Hole	13,000#	444074	73.40	G
----	7-3/4" Drop	10-1/2"	1-1/4" Hole	13,000#	444075*	99.85	G
1-1/2"	3" Drop	10"	1-1/4" Hole	18,000#	444076	85.74	G
3-1/2"	5" Drop	10"	1-1/4" Hole	18,000#	444077	93.48	G

* Note: Use in Drop Position Only

M. V. L. = MAXIMUM VERTICAL LOAD

M. G. T. W. = MAXIMUM GROSS TOWING WEIGHT

TRAILER

- tires & wheels
- axles, hubs & springs
- tongue accessories
- hitches**
- electrical
- brake parts
- trailer hardware
- locks & pins
- towing & loading
- tie downs
- tools
- chemicals



BY3313

BALL MOUNT KITS 2" SHANKS

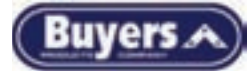

- Kit includes ball mount assembled with chrome ball and hitch pin
- Ball mounts fit 2" receiver tubes
- Chrome or black powder coated ball mount
- Two-piece welded steel construction
- 5000# chrome towing ball - 2"
- 6000# chrome towing ball - 2-5/16"
- Ball Mount Capacity: 6000 lbs M.G.T.W., 600 lbs Maximum Vertical Load



Buy 3 of the same # to receive a free display box!

DESCRIPTION	BALL SIZE	MAX DROP	PART #		
Chrome Ball Mount	1-7/8"	2"	BY3303	36.95	G
Chrome Mount w/Chrome Ball	2"	2"	BY3306	32.95	J
Chrome Mount w/Chrome Ball & Receiver Lock	2"	2"	BY3306LP	49.95	G
Black Mount w/Chrome Ball	2"	2"	BY3307	27.95	G
Black Ball Mount w/Chrome Ball	2-5/16"	2"	BY3308	31.95	G
Black Mount w/Chrome Ball	1-7/8"	4"	BY3312	26.95	G
Black Mount w/Chrome Ball	2"	4"	BY3313	29.95	G
Black Mount w/Chrome Ball	2-5/16"	4"	BY3314	36.95	G

TRAILER



DOUBLE BALL MOUNT - 2" SHANKS



- Tube-style ball mounts with 2" drop
- Fits 2" receiver tubes
- Welded steel construction
- Weld on balls in three combinations
- Black powder coated for corrosion resistance
- Ball Mount Capacity: 6000 lbs. MGTW., 600 lbs. Max. Vertical Load

SIZE	LENGTH	MAX DROP	PART #		
1-7/8" & 2" Ball	8"	2"	BY3210	54.95	G
1-7/8" & 2-5/16" Ball	8"	2"	BY3213	42.60	G
2" & 2-5/16" Ball	8"	2"	BY3215	58.95	G



MULTI-BALL HITCHES DOUBLE BALL MOUNT

- Each double ball mount features a solid receiver for 2" receiver tubes, welded steel towing balls, black powder coat finish, a 5/8" hitch pin hole and are individually boxed for shipping
- Offered in the 1-7/8" and 2" versions and the 2" and 2-5/16" versions

SIZE	CAPACITY	PART #		
2", 2-5/16" Ball	7,500 lbs.	BY2215	58.95	E

M. V. L. = MAXIMUM VERTICAL LOAD

M. G. T. W. = MAXIMUM GROSS TOWING WEIGHT

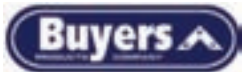

MULTI-BALL HITCHES DOUBLE BALL MOUNT



- Each double ball mount features a solid receiver for 2" receiver tubes, welded steel towing balls, black powder coat finish, a 5/8" hitch pin hole and are individually boxed for shipping
- Offered in the 1-7/8" and 2" versions and the 2" and 2-5/16" versions

SIZE	CAPACITY	PART #		
2", 2-5/16" Ball	7,500 lbs.	BY2215	58.95	E

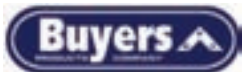

TRI-BALL HITCH -TUBULAR

30% STRONGER!



- Ball Capacity: 1-7/8" - 6,000#, 2" - 7,500#, 2-5/16" - 10,000#
- Fits 2" receiver
- Chrome welded steel towing balls
- Black powder coated finish
- 5/8" hitch pin hole
- Lightweight for easy handling & heavy-duty towing capacity
- Packaged for retail display

BY2207	64.95	E
--------	-------	---

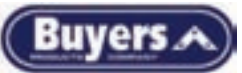

TRI-BALL HITCH WITH HOOK -TUBULAR



- Ball Capacity: 1-7/8" - 6,000#, 2" - 7,500#, 2-5/16" - 10,000#
- Hook Capacity: 10,000#
- Fits 2" receiver
- Black welded steel towing balls and hook
- Black powder coated finish
- 5/8" hitch pin hole
- Retail packaging

BY2208	96.95	E
--------	-------	---

tires & wheels

axles, hubs & springs

tongue accessories

hitches

electrical

brake parts

trailer hardware

locks & pins

towing & loading

tie downs

tools

chemicals

TRAILER

- tires & wheels
- axles, hubs & springs
- tongue accessories
- hitches**
- electrical
- brake parts
- trailer hardware
- locks & pins
- towing & loading
- tie downs
- tools
- chemicals



ADJUSTABLE TRI-BALL MOUNT - CHROME

- 1-7/8", 2", 2-5/16" balls
- Solid shank for 2" receiver tubes, welded steel towing balls, black powder coat finish, and a 5/8" hitch pin hole
- Individually boxed for shipping
- All three towing ball sizes (1-7/8", 2" and 2-5/16") on one solid shank
- 12" vertical adjustment

BY2225 213.95 E

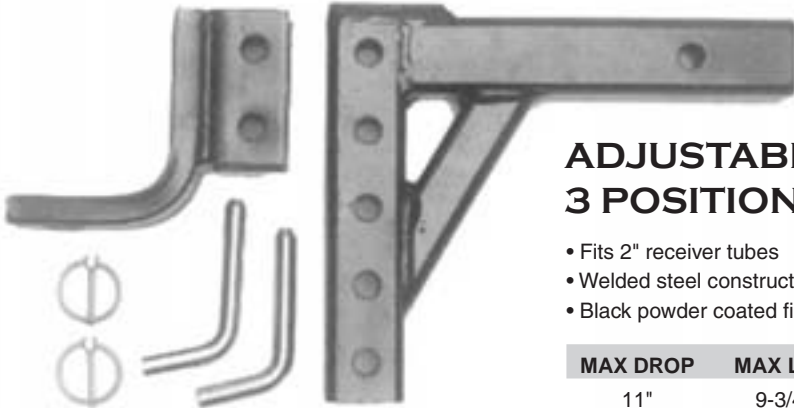

ADJUSTABLE BALL MOUNT - 3 POSITIONS

- Fits 2" receiver tubes
- Welded steel construction
- Black powder coated finish



MAX DROP	MAX LIFT	M.V.L	M.G.T.W.	PART #		
11"	9-3/4"	600#	6,000#	BY3090	62.95	H



ADJUSTABLE BALL MOUNT - 4 POSITIONS

- Fits 2" receiver tubes
- Welded steel construction
- Black powder coated finish



MAX DROP	MAX LIFT	M.V.L	M.G.T.W.	PART #		
8"	6-3/4"	600#	6,000#	BY3093	63.95	G

TRI-BALL MOUNT WITH PINTLE HOOK

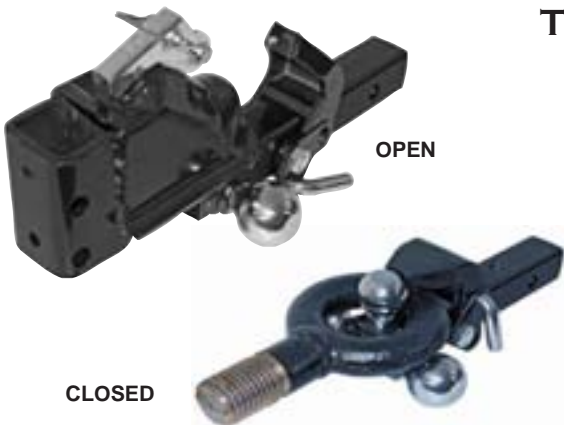

- Features 3 towing balls and a pintle hook on 1 solid steel shank
- Black powder coated shank fits 2" receivers
- 5/8" Hitch Pin hole
- 1-7/8", 2", 2-5/16" welded steel tubing ball
- 7500# cast steel pintle jaw
- Upper jaw locks in the open (up) position for coupler towing
- Upper jaw locks in the closed (down) position for lunette eye towing



BY2279 139.95 H

CAPACITY	
1-7/8" Ball	6,000 lbs M.G.T.W.
2" Ball	7,500 lbs M.G.T.W.
2-5/16" Ball	10,000 lbs M.G.T.W.
Pintle cap	7,500 lbs M.G.T.W.

M. V. L. = MAXIMUM VERTICAL LOAD

M. G. T. W. = MAXIMUM GROSS TOWING WEIGHT

RECEIVER TUBES - 2"



- Features:
- 2" receiver tubes
 - Cast steel collar
 - Black powder coated finish
 - Solid stress collar opening
 - 5/8" hitch pin hole



DIMENSIONS	PART #		
2" ID x 6" Long	BY25806	17.95	G
2" ID x 8" Long	BY25808	21.95	H
2" ID x 10" Long	BY25810	23.95	G
2" ID x 12" Long	BY25812	26.95	H
2" ID x 18" Long	BY25818	35.95	G
2" ID x 24" Long	BY25824	45.95	G
2" ID x 36" Long	BY25836	65.95	G

RECEIVER TUBES - 1-1/4" & 2-1/2"



- Features:
- Steel collar
 - Plain finish



DIMENSIONS	PART #		
1-1/4" ID x 6" Long, 1/2" Pin Hole	BY1206	20.95	G
2-1/2" ID x 8" Long, 5/8" Pin Hole	BY5808	29.95	G

2-1/2" TO 2" RECEIVER TUBE ADAPTOR



- Features:
- Reduces sleeve slides inside 2-1/2" receiver
 - Accepts all 2" hitch accessories
 - Zinc plated steel
 - Rounded corners
 - 5/8" hitch pin hole

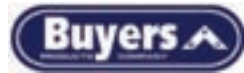

BY252 18.95 G

STEP BUMPER HITCH - 2" X 2" OPENING



- Features:
- Fits most full size trucks with step bumpers
 - Accepts many 2" square ball mounts or accessories
 - Black powder coated finish



M.V.L.	M.G.T.W.	PART #	
350#	3,500#	BY0020	43.95 G

RECEIVER EXTENSION WITH STEP



- Same features as above
- 2 lengths 12" & 18"
- Step models include 6" x 17" welded steel step with diamond tread for extra traction

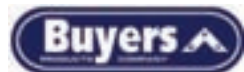

DESCRIPTION	CAPACITY	PART #	
12" Receiver Extension with Step	Reduces Hitch Capacity by 1/3	BY4015	80.95 G
18" Receiver Extension with Step	Reduces Hitch Capacity by 1/3	BY4017	94.95 L

- tires & wheels
- axles, hubs & springs
- tongue accessories
- hitches**
- electrical
- brake parts
- trailer hardware
- locks & pins
- towing & loading
- tie downs
- tools
- chemicals

TRAILER

- tires & wheels
- axles, hubs & springs
- tongue accessories
- hitches**
- electrical
- brake parts
- trailer hardware
- locks & pins
- towing & loading
- tie downs
- tools
- chemicals



HITCH ADAPTER 1-1/4" TO 2"

- Converts a 1-1/4" receiver tube to a 2" hitch
- Ideal for light-duty receiver hitch accessories
- Cast steel collar
- Black powder coated finish
- 5/8" hitch pin holes
- Reduced hitch capacity

M.V.L.	M.G.T.W.	PART #		
300#	N/A	BY4030	30.95	H



RECEIVER EXTENSION

- Extend your receiver by 7", 12" or 18"
- Cast steel collar
- Accepts all 2" hitch accessories
- Black powder coat finish
- 5/8" hitch hole
- 3 lengths

DESCRIPTION	CAPACITY	PART #		
7" Receiver Extension	Reduces Hitch Capacity by 1/3	BY4003	43.95	G
12" Receiver Extension	Reduces Hitch Capacity by 1/3	BY4005	49.95	G
18" Receiver Extension	Reduces Hitch Capacity by 1/3	BY4007	69.95	G

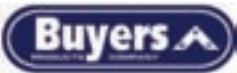

HITCH ADAPTER 2" TO 1-1/4"

- Converts a 2" receiver tube to a 1-1/4" hitch
- Cast steel collar
- Black powder coat finish
- 1/2" hitch pin included

M.V.L.	M.G.T.W.	PART #		
300#	3,000#	BY4035	22.95	G

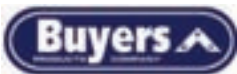

RECEIVER EXTENSION

- Dual receiver
- 12" extension

M.V.L.	M.G.T.W.	PART #		
400#	4,000#	BY4010	95.90	G

RV BUMPER RECEIVER ADAPTER



Features:

- Fits standard 4" and 4-1/2" square RV bumpers
- Zinc plated hardware included
- Ideal for bike carriers and other accessories
- Accepts 2" tubes
- Assembly required
- Boxed (7 lbs)

Notice:

- **Not for towing**
- **Not for use on decorative aluminum bumper covers**

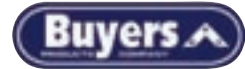

BY24 39.95 G

tires & wheels

axles, hubs & springs

tongue accessories

hitches

electrical

brake parts

trailer hardware

locks & pins

towing & loading

tie downs

tools

chemicals

TRAVEL TRAILER HITCH



Features:

- Easy to install
- 2" receiver opening
- Mounts to 4" square tube bumper of RV
- Zinc plated hardware included
- M.G.T.W.: 3,500 lbs
- Tongue weight: 350 lbs
- Class II
- Assembly required
- Boxed (9.5 lbs)

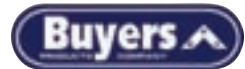

BY4060 92.95 G

RECEIVER TUBE COVERS



SIZE		PART #		
1-1/4" Square	Chrome, Metal	DT5351	24.48	B
2" Square	Chrome, Metal	444063	40.58	B
2" Square	Black Plastic	444066	3.77	B
2" Square	Elite Black Nylon	444070	7.97	B

TITAN 2-1/2" RECEIVER TUBE COVERS



SIZE	PART #	
2-1/2" Square	444078	27.50 G

2" RECEIVER TUBE COVERS

Includes Brake Light with 4-Flat Plug



SIZE	PART #	
2" Square	444072	27.87 B

UNIVERSAL RECEIVER TUBE COVERS



SIZE		PART #	
2" Square	Chevy Logo	444067	63.43 B
2" Square	Dodge Ram Logo	444068	63.43 B
2" Square	Ford Logo	444069	63.43 B

TRAILER

- tires & wheels
- axles, hubs & springs
- tongue accessories
- hitches**
- electrical
- brake parts
- trailer hardware
- locks & pins
- towing & loading
- tie downs
- tools
- chemicals



RECEIVER MOUNT TOW HOOK

- Fits 2" receiver tubes
- 10,000# capacity
- Black powder coat finish resists corrosion
- Straight pattern



BY10H 31.95 G



FORGED RECEIVER MOUNT TOW HOOK

- Fits 2" receiver tubes
- 12,000# capacity
- Black powder coat finish to resist corrosion
- Straight pattern

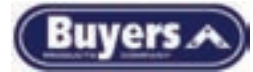

BY12H 48.95 G



FORGED RECEIVER MOUNT TOW EYE

- Fits 2" receiver tubes
- 12,000# capacity
- Black powder coat finish to resist corrosion
- Straight pattern

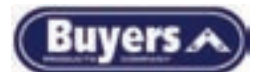

BY1225E 48.95 G



DROP FORGED HEAVY DUTY TOWING HOOK

- 3 hole
- Black finish
- 12,000# safe working load (per hook)

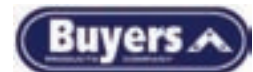

BY076 32.95 E



HEAVY DUTY TOWING SHACKLE

- Drop forged
- Black finish
- 18,000# safe working load (per hook)

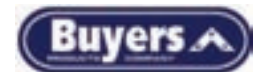

BY0681 75.95 G



CLEVIS BALL MOUNTS

- Fits 2" receiver tubes
- Uses 1" diameter shank towing ball
- Black powder coated finish
- 9-1/4" length

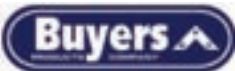

M.V.L.	M.G.T.W.	PART #	
600#	6000#	BY3060	42.95 G
800#	8000# (Solid Shank)	BY3065	51.95 G



FORGED ALLOY STEEL DRAWBAR WITH NUT

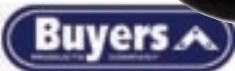

DESCRIPTION	M. V. L.	M. G. T. W.	PART #	
2.5" I. D. Eye, 5-1/2" OD, 1-1/2" Section Drawbar	3,000#	15,000#	BY2503	60.95 G
3" I.D. Eye, 6-1/4" OD, 1-5/8" Section Drawbar	9,000#	45,000#	BY2492	91.95 G

- tires & wheels
- axles, hubs & springs
- tongue accessories
- hitches**
- electrical
- brake parts
- trailer hardware
- locks & pins
- towing & loading
- tie downs
- tools
- chemicals



RIGID TYPE PINTLE HOOK - 5 TON & 8 TON

INCLUDES MOUNTING INSTRUCTIONS

- Drop forged steel
- Black powder coated finish
- Locking pin included
- Drawbar eye dimensions: 2" to 3" ID with 1-1/4" to 1-5/16" diameter section
- Boxed



BOLT KIT TO MOUNT NOT INCLUDED

BY8520 6.95 G

	M. V. L.	M. G. T. W.	PART #		
5 Ton	2,000#	10,000#	BY4205	54.95	G
8 Ton	3,200#	16,000#	BY4208	57.95	G



RIGID TYPE PINTLE HOOK - 15 TON

INCLUDES MOUNTING INSTRUCTIONS

- Drop forged steel
- Black powder coated finish
- Locking pin included
- Drawbar eye dimensions: 2" to 3" ID with 1-1/4" to 1-5/8" diameter section



BOLT KIT TO MOUNT NOT INCLUDED

BY8520 6.95 G

	M. V. L.	M. G. T. W.	PART #		
15 Ton	6,000#	30,000#	BY4206	75.95	G



RIGID TYPE PINTLE HOOK - 20 TON

INCLUDES MOUNTING INSTRUCTIONS

- Drop forged steel
- Black powder coated finish
- Locking pin included
- Drawbar eye dimensions: 2" to 3" ID with 1-1/4" to 1-5/8" diameter section

BOLT KIT TO MOUNT NOT INCLUDED

BY8525 11.15 L

	M. V. L.	M. G. T. W.	PART #		
20 Ton	8,000#	40,000#	BY4220	99.95	D



BOLT-ON RECEIVER TUBE - 10 TON

- 2" receiver tube welded to 1/2" thick steel mounting plate with standard 4-Hole pintle hook pattern
- Cast steel collar
- Solid stress collar opening
- 5/8" hitch pin hole
- Black powder coat finish

DESCRIPTION	M. V. L.	M. G. T. W.	PART #		
2-1/5" x 6"	2,000#	20,000#	BY4055	62.95	G

M. V. L. = MAXIMUM VERTICAL LOAD

M. G. T. W. = MAXIMUM GROSS TOWING WEIGHT

TRAILER

- tires & wheels
- axles, hubs & springs
- tongue accessories
- hitches**
- electrical
- brake parts
- trailer hardware
- locks & pins
- towing & loading
- tie downs
- tools
- chemicals

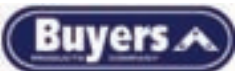

Patented Design

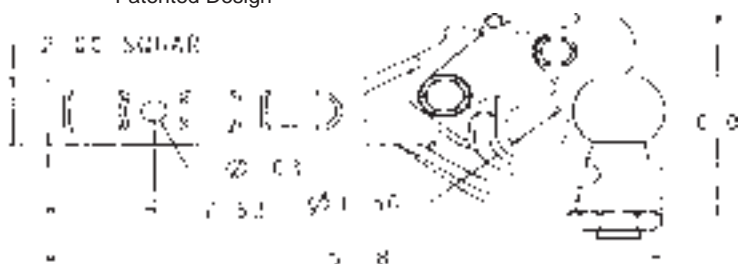

RECEIVER MOUNT - COMBINATION BALL HITCH - 6 TON

WITH INSTALLATION INSTRUCTION SHEETS OR TEMPLATES AND CAPACITY DECALS

- Single piece, drop forged lower jaw
- Integral shank fits all 2" receiver tubes
- Finished with black powder coat for superior durability and corrosion resistance
- Eliminates the need for a more costly assembly consisting of a ball hitch, pintle mount and mounting hardware, plus a significant weight savings
- Individually boxed for storage, shipping and retail display
- Drawbar eye dimensions: 2-1/2" to 3" ID with 1-1/4" to 1-9/16" diameter section
- Capacity: 12,000 lbs. M.G.T.W., 2,400# Maximum Vertical Load

BALL SIZE	PART #		
1-7/8"	BY61780	126.95	E
2"	BY62000	126.95	J
2-5/16"	BY62516	132.95	G
Pin w/Chain	BY1100	2.95	H

REPLACEMENT CHROME BALL FOR THIS PINTLE

BALL SIZE	PART #		
1-7/8"	BY1780	31.95	H
2"	BY2000	28.90	G
2-5/16"	BY2516	37.95	H

TRAILER

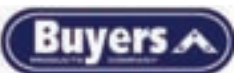

Patented Design



DESCRIPTION	PART #	PRICE	TYPE
Receiver Mount - Pintle Hook	BY0050	78.95	E

RECEIVER MOUNT - PINTLE HOOK, 5 TON

WITH INSTALLATION INSTRUCTION SHEETS OR TEMPLATES AND CAPACITY DECALS

- Single piece, drop forged lower jaw
- Integral shank fits all 2" receiver tubes
- Finished with black powder coat for superior durability and corrosion resistance
- Eliminates the need for a more costly assembly consisting of a pintle hook and mounting hardware, plus a significant weight savings
- Individually boxed for storage, shipping and retail display
- Drawbar eye dimensions: 2" to 3" ID with 1-1/4" to 1-5/8" diameter section
- Capacity: 10,000 lbs. M.G.T.W., 2,000# Maximum Vertical Load



TRAILER NOSE PLATE

- Features:
- Accepts standard 4-1/2" square bolt pattern found on most drawbars
 - Allows 3 mounting positions

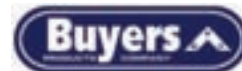

THICKNESS	HOLES	MEASUREMENTS	PART #	
3/4"	8-21/32"	30,000#	BY25750	68.95 G



8-TON FORGED ALLOY STEEL COMBINATION HITCH

INCLUDES DRILLING TEMPLATE & CAPACITY DECALS

- Drop forged combination pintle hook/ball hitch
- Forged steel ball
- Interchangeable hitch balls
- Finished with black powder coat for superior durability and corrosion resistance
- Capacity: 16,000 lbs. M.G.T.W., 3,000# Maximum Vertical Load
- **BOLT KIT TO MOUNT IS NOT INCLUDED**
- Drawbar eye dimensions: 2-1/2" to 3" ID with 1-1/4" to 1-9/16" diameter section



BOLT KIT TO MOUNT NOT INCLUDED

BY8520 6.95 G

BALL SIZE	PART #		
1-7/8"	BY4202	98.95	G
2"	BY4203	98.95	G
2-5/16"	BY4204	105.95	H
Pin w/Chain	BY1100	2.95	H

REPLACEMENT CHROME BALL FOR THIS PINTLE

BALL SIZE	PART #		
1-7/8"	BY1780	31.95	H
2"	BY2000	28.90	G
2-5/16"	BY2516	37.95	H



10-TON HITCH - DROP FORGED, BLACK POWDER COAT FINISH

WITH INSTALLATION INSTRUCTION SHEETS OR TEMPLATES AND CAPACITY DECALS

- Capacity: 20,000 lbs. M.G.T.W., 4,000 lbs. Maximum Vertical Load
- Drop forged combination pintle hook/ball hitch
- Forged steel ball
- Interchangeable hitch balls
- Finished with black powder coat for durability and corrosion resistance
- Drawbar eye dimensions: 2-3/8" to 3" up to 1-9/16" cross section



BOLT KIT TO MOUNT NOT INCLUDED

BY8520 6.95 G

BALL SIZE	PART #		
2"	BY10052	163.95	E
2-5/16"	BY10057	171.95	E

REPLACEMENT CHROME BALL FOR THIS PINTLE

BALL SIZE	PART #		
2"	BY2000	28.90	G
2-5/16"	BY2516	37.95	H

PINTLE HOOK MOUNT

These mounts are designed to adapt receiver tubes to multi-height pintle hook applications

Features:

- Continuous welds
- Solid shank
- 2" Shank diameter
- Epoxy coating
- 10,000# capacity
- 1,000# tongue weight

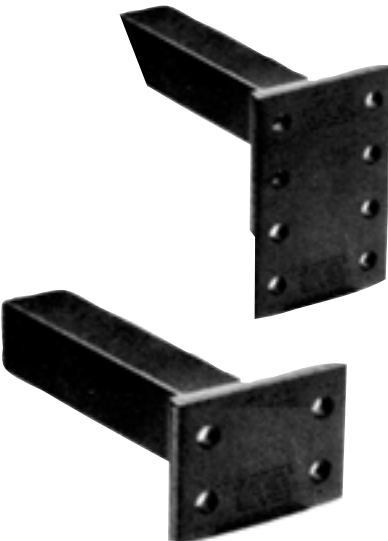

SHANK DIMENSIONS	PLATE DIMENSIONS	PAIR OF HOLES	M. V. L.	M. G. T. W.	PART #	
2" x 9"	5" x 7.38"	4	2,000#	10,000#	BY870	62.60 G
2" x 10.25"	5" x 7.38"	4	2,000#	10,000#	BY107	69.95 B
2" x 12.25"	5" x 12.50"	7	2,000#	10,000#	BY812	94.95 G
2" x 9"	5" x 3.75"	2	4,000#	20,000#	BY840	63.75 G
2" x 10.25"	5" x 5.75"	3	2,800#	14,000#	BY105	66.90 H

- tires & wheels
- axles, hubs & springs
- tongue accessories
- hitches**
- electrical
- brake parts
- trailer hardware
- locks & pins
- towing & loading
- tie downs
- tools
- chemicals

TRAILER

- tires & wheels
- axles, hubs & springs
- tongue accessories
- hitches**
- electrical
- brake parts
- trailer hardware
- locks & pins
- towing & loading
- tie downs
- tools
- chemicals

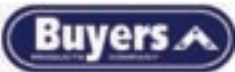

4-BOLT MOUNT DRAWBAR

Features:

- Alloy steel forging
- Black powder coated finish
- 2-1/2" ID eye with 1-1/2" section
- Drawbar welded to 4 hole square mounting plate

M.V.L.	M.G.T.W.	PART #	
7,000#	42,000#	BY25015	82.95 G

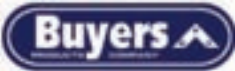

4-BOLT MOUNT DRAWBAR

Features:

- One piece forged design
- Alloy steel forging
- Black powder coat finish
- 2-1/2" ID eye with 1-1/2" section drawbar with 4 hole mounting plate

M.V.L.	M.G.T.W.	PART #	
7,000#	42,000#	BY12515	92.95 G



HEAVY DUTY FORGED 4-BOLT MOUNT DRAWBAR

Features:

- One piece forged design for safety and capacity
- Alloy steel forging
- Black powder coat finish
- 3" ID eye with 1.62 section drawbar with 4 square mounting holes
- .78" mounting hole size

M.V.L.	M.G.T.W.	PART #	
15,000#	60,000#	BY1385	120.95 G

M. V. L. = MAXIMUM VERTICAL LOAD M. G. T. W. = MAXIMUM GROSS TOWING WEIGHT





DRAWBAR LOCK

Features:

- Zinc plated
- Fits all 2-1/2"-3" lunette eyes
- Accept most 1/2" diameter padlocks (not included)



BY253 26.95 E

tires & wheels

axles, hubs & springs

tongue accessories

hitches

electrical

brake parts

trailer hardware

locks & pins

towing & loading

tie downs

tools

chemicals

ADJUSTABLE EYE ASSEMBLY



3 POSITION CHANNEL AND FASTENERS

- Ductile cast iron eye
- Formed steel channel
- 3" ID eye opening
- 1-9/16" eye section



M.V.L.	M.G.T.W.	PART #	
2,000#	12,000#	BY18128	46.95 E

5 POSITION CHANNEL AND FASTENERS



- Ductile cast iron eye
- Formed steel channel
- 3" ID eye opening
- 1-9/16" eye section



M.V.L.	M.G.T.W.	PART #	
2,000#	14,000#	BY20135	69.95 G

EYE ONLY



- Ductile cast iron eye
- 3" ID eye opening
- 1-9/16" eye section



M.V.L.	M.G.T.W.	PART #	
2,000#	14,000#	BY16137	34.95 G

TRAILER

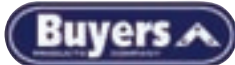

BIKE CARRIER - 4 BIKES, TOWABLE

- tires & wheels
- axles, hubs & springs
- tongue accessories
- hitches**
- electrical
- brake parts
- trailer hardware
- locks & pins
- towing & loading
- tie downs
- tools
- chemicals



- Fits all 2" receiver tubes
- Black powder coated / rubber coated finish
- Lockable (lock not included)
- Towing ball sold separately
- Fold down arms when not in use
- Fold down feature allows access to rear of vehicle



WEIGHT	M.G.T.W.	PART #	
44#	3,500#	BY5005	156.95 E

HITCH ADAPTER 1-1/4" TO 2"



- Converts a 1-1/4" receiver tube to a 2" hitch
- Ideal for light-duty receiver hitch accessories
- Cast steel collar
- Black powder coated finish
- 5/8" hitch pin holes
- Reduced hitch capacity

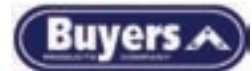

M.V.L.	PART #		
300#	BY4030	30.95	H

ALL PURPOSE UTILITY CARRIER

LR86112 162.97 B

- 500 lb. carrying capacity
- Galvanized 20" x 60" deck pan
- 16 gauge
- Solid bottom repels road grime
- Fits all 2" hitch receivers
- Dimpled floor reduces cargo shifting
- Installs in minutes
- Tie down hook slots on all sides
- UPS shippable
- 20" x 20" full color display box
- Available 1-1/4" receiver kit for class 2 hitches (see above part # **BY4030**)



FOLD-UP UTILITY CARRIER

- Same features as the 500 lb. all purpose utility carrier, now available with a fold-up hitch unit
- Fits all 2" hitch receivers

LR86168 167.15 B





ELECTRICAL

- tires & wheels
- axles, hubs & springs
- tongue accessories
- hitches
- electrical**
- brake parts
- trailer hardware
- locks & pins
- towing & loading
- tie downs
- tools
- chemicals



LED LIGHTS

ALL LIGHTS ARE DOT & SAE APPROVED



LED STOP, TURN, TAIL LIGHTS RED

- Includes grommet and plug
- Retail packaged

PART #	MFG #	DESCRIPTION		
BY26520	5626520	6-1/2" Oval Light - 20 Diodes	23.95	G
BY24118	5624118	4" Round Light - 18 Diodes	20.95	G



LED BACK-UP LIGHTS CLEAR

- Includes grommet and plug
- Retail packaged

PART #	MFG #	DESCRIPTION		
BY26324	5626324	6-1/2" Oval Light - 24 Diodes	45.95	G
BY24324	5621324	4" Round Light - 24 Diodes	45.95	G



LED TURN & PARK LIGHTS AMBER

- Includes grommet and plug
- Retail packaged

PART #	MFG #	DESCRIPTION		
BY26210	5626210	6-1/2" Oval Light - 10 Diodes	17.95	E
BY24210	5624210	4" Round Light - 10 Diodes	17.95	E



LED MARKER LIGHTS AMBER & RED

- Includes grommet and plug
- Retail packaged

PART #	MFG #	DESCRIPTION		
BY27523	5627523	3/4" Round Light - 3 Diodes - Amber	7.95	L
BY27513	5627513	3/4" Round Light - 3 Diodes - Red	7.95	G



LED STROBE LIGHTS

- 100,000 hour rated life - Quad flash amber or clear strobe light
- 12-24 VDC - 3 pin quick plug wire harness & grommet included (BY6500 & BY4000) - No external power pack required - BY6502 & BY4002 are direct wired
- Retail packaged

PART #	MFG #	DESCRIPTION		
BY6500	SL65AO	6-1/2" Oval Strobe Light - Amber	46.95	G
BY6502	SL65CO	6-1/2" Oval Strobe Light - Clear	58.95	G
BY4000	SL40AR	4" Round Strobe Light - Amber	46.95	G
BY4002	SL40CR	4" Round Strobe Light - Clear	58.95	G

☆ Connect black wires for synchronized strobe pattern or leave unconnected for random strobe pattern. ☆

New harder durometer rubber seal for better light fit

New wider base prevents vibration



LED UTILITY LIGHT CLEAR

- Rugged all purpose utility light - Shock resistant & waterproof
- 5" sealed rubber housing with polycarbonate lens
- 4.92" H x 3.15" D x 7" H
- Retail packaged

PART #	MFG #	DESCRIPTION		
BY2110	1492110	54 Diodes	43.95	G



LED TECHNOLOGY
FOR BRIGHT DEPENDABLE PERFORMANCE



- tires & wheels
- axles, hubs & springs
- tongue accessories
- hitches
- electrical
- brake parts
- trailer hardware
- locks & pins
- towing & loading
- tie downs
- tools
- chemicals

LED 6" OVAL SEALED SURFACE MOUNT STOP/TURN/TAIL LIGHT



- Features sonically sealed, waterproof lens and housing in a single unit - Hardwired
- Surface mount unit does not require panel cut out
- Clamshell packaged

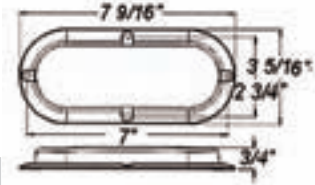

PART #	MFG #	DESCRIPTION		
OP1118	STL-78RK	10 Diodes	30.50	G

LED 6" OVAL SEALED FLUSH MOUNT STOP/TURN/TAIL LIGHT



- Features sonically sealed, waterproof lens and housing in a single unit complete with grommet and 3 prong pigtail
- Replacement grommet and 3 prong pigtail available
- Clamshell packaged

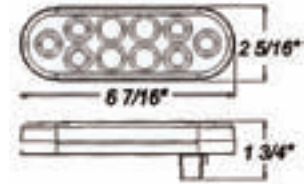

PART #	MFG #	DESCRIPTION		
OP726	STL-72RK	10 Diodes	31.10	G

LED 4" ROUND SEALED FLUSH MOUNT STOP/TURN/TAIL LIGHT



- Features sonically sealed, waterproof lens and housing in a single unit complete with grommet and 3 prong pigtail
- Replacement grommet and 3 prong pigtail available
- Clamshell packaged

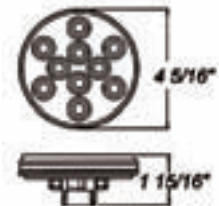

PART #	MFG #	DESCRIPTION		
OP436	STL-43RK	10 Diodes	33.60	G

LED THIN LINE DUAL LENS STOP/TURN/TAIL LIGHT



- Features replaceable, red outer lens stream line designed - Clear polycarbonate inner lens is sonic welded to housing for durability
- Packaged in bulk

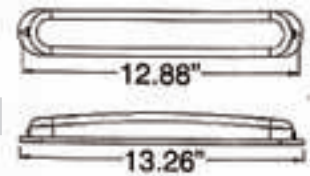

PART #	MFG #	DESCRIPTION		
OP766	STL-76RB	11 Diodes	31.00	G

TRAILER



MARKER / CLEARANCE LIGHTS

LED 2" ROUND SEALED MARKER/CLEARANCE LIGHTS



- Multiple diode **LED** clearance or side marker light features sonically sealed, waterproof lens and housing in a single unit
- Complete with grommet and plug

PART #	MFG #	DIODES	COLOR	PACKAGING		
OP557	ML-55AK	4 Diodes	Amber	Clamshell	14.05	G
OP556	MCL-55RK	3 Diodes	Red	Clamshell	14.05	G



LED 2.5" ROUND SEALED MARKER/CLEARANCE LIGHTS



- Multiple diode **LED** clearance or side marker light features sonically sealed, waterproof lens and housing in a single unit
- Complete with grommet and plug

PART #	MFG #	DIODES	COLOR	PACKAGING		
OP577	MCL-57AK	4 Diodes	Amber	Clamshell	15.15	G
OP576	MCL-57RK	3 Diodes	Red	Clamshell	15.15	G

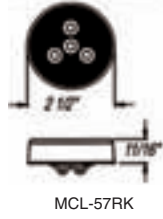

LED THIN LINE SEALED MARKER/CLEARANCE LIGHTS



- 6 diode **LED** clearance or side marker light features sonically sealed, waterproof lens and housing in a single unit
- Complete with base and plug assembly

PART #	MFG #	DIODES	COLOR	PACKAGING		
OP676	MCL-67RK	6 Diodes	Red	Clamshell	12.95	G

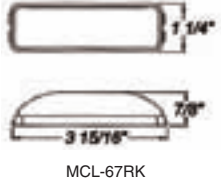

LED MINI THIN LINE SEALED MARKER/CLEARANCE LIGHTS

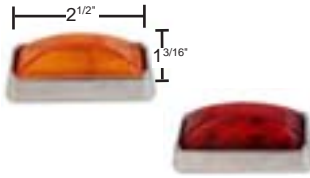

- 6 diode **LED** clearance or side marker light features sonically sealed, waterproof lens and housing in a single unit
- Complete with base and plug assembly (see page 61 for replacement)

PART #	MFG #	DIODES	COLOR	PACKAGING		
OP915	MCL-91AK	3 Diodes	Amber	Clamshell	10.05	G
OP916	MCL-91RK	3 Diodes	Red	Clamshell	10.05	G

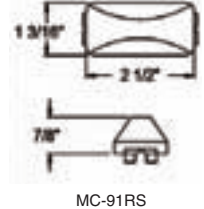

LED SEALED 3 PIECE IDENTIFICATION LIGHT BAR



- A **LED** ID light bar features all-weather molded plastic housing and durable lens to protect against corrosion
- Watertight connection to the electrical harness

PART #	MFG #	DIODES	COLOR	PACKAGING		
OP936	MCL-93RK	9 Diodes	Red	Carded	29.25	G



LED SEALED 3 PIECE IDENTIFICATION LIGHT BAR



- Sealed stainless **LED** ID light bar for over 80° applications
- Watertight connection to the electrical harness
- Features sonically sealed, waterproof light capsules

PART #	MFG #	DIODES	COLOR	PACKAGING		
OP938	MCL-97RK	9 Diodes	Red	Carded	30.15	G

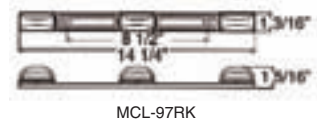

tires & wheels
axles, hubs & springs
tongue accessories
hitches
electrical
brake parts
trailer hardware
locks & pins
towing & loading
tie downs
tools
chemicals

TRAILER



TRAILER LIGHT KITS

EACH ITEM SHOWN HERE CAN BE PURCHASED SEPARATELY

UNIVERSAL WATERPROOF OVER 80" AERO PRO TRAILER LIGHT KIT



PART #		DESCRIPTION	REPL. LENS (BULK)
OP360	52.95	G (1) Light Kit (As Shown)	-----
OP362	14.25	G (1) Right Side Tail Light	Rear OP365, Side OP366
OP363	14.60	G (1) Left Side Tail Light	Rear OP365, Side OP366
OP917	4.60	H (2) Clearance Lights	-----
OP250	17.35	G (1) 25' Wire Harness (Wishbone)	-----

(1) license plate bracket also included.

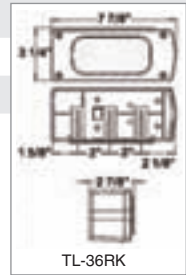

TL-36RK

UNIVERSAL LOW PROFILE WATERPROOF OVER 80" TRAILER LIGHT KIT



Low profile • Includes 2 taillights • 2 amber side lights • License plate bracket • 25-ft. wiring harness • Stainless hardware • Clamshell packaged

PART #		DESCRIPTION	REPL. LENS (BULK)
OP160	53.60	G (1) Light Kit (As Shown)	-----
OP162	15.15	G (1) Right Side Tail Light	Rear & Side OP169
OP164	15.50	G (1) Left Side Tail Light	Rear & Side OP169
OP917	4.60	H (2) Clearance Lights	-----
OP250	17.35	G (1) 25' Wire Harness (Wishbone)	-----

(2) amber reflectors & (1) license plate bracket also included.

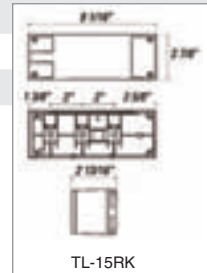

TL-15RK

UNIVERSAL SUBMERSIBLE UNDER 80" TRAILER LIGHT KIT



Kit includes 2 submersible stud mount tail lights, two amber side markers and a corrosion proof license plate bracket • Retail packaged

PART #		DESCRIPTION	REPL. LENS (BULK)
OP501	38.35	G (1) Light Kit (As Shown)	-----
OP902	10.05	G (1) Right Side Tail Light	Rear OP170, Side OP172
OP904	10.40	G (1) Left Side Tail Light	Rear OP170, Side OP172
OP250	17.35	G (1) 25' Wire Harness (Wishbone)	-----

(2) amber clearance lights & (1) license plate bracket also included.

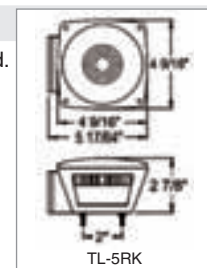

TL-5RK

- tires & wheels
- axles, hubs & springs
- tongue accessories
- hitches
- electrical
- brake parts
- trailer hardware
- locks & pins
- towing & loading
- tie downs
- tools
- chemicals

TRAILER



TRAILER LIGHT KITS

EACH ITEM SHOWN HERE CAN BE PURCHASED SEPARATELY

UNIVERSAL SUBMERSIBLE UNDER 80” TRAILER LIGHT KIT

Kit includes 2 submersible stud mount tail lights and a corrosion proof license plate bracket • Retail packaged



PART #		DESCRIPTION	REPL. LENS (BULK)
OP900	33.10	G (1) Light Kit (As Shown)	-----
OP902	10.05	G (1) Right Side Tail Light	Rear OP170, Side OP172
OP904	10.40	G (1) Left Side Tail Light	Rear OP170, Side OP172
OP250	17.35	G (1) 25' Wire Harness (Wishbone)	-----

(1) license plate bracket (polymer)

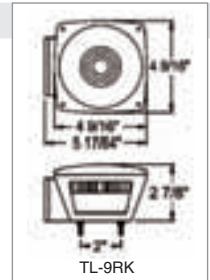

UNIVERSAL UNDER 80” TRAILER LIGHT KIT

Grounds through mounting studs • Mounts on 2” centers • Shock proof socket for longer bulb life • Includes 2 stud mount Plug-N-Go taillights • License plate bracket • 25-ft wiring harness and mounting hardware • Clamshell packaged



PART #		DESCRIPTION	REPL. LENS (BULK)
OP800	30.70	G (1) Light Kit (As Shown)	-----
OP802	9.15	G (1) Right Side Tail Light	Rear OP170, Side OP172
OP804	9.35	H (1) Left Side Tail Light	Rear OP170, Side OP172

(1) 20' trailer harness & (1) license plate bracket

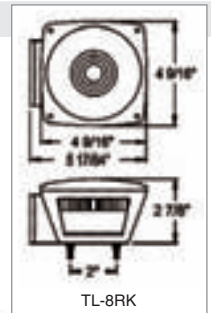

- tires & wheels
- axles, hubs & springs
- tongue accessories
- hitches
- electrical
- brake parts
- trailer hardware
- locks & pins
- towing & loading
- tie downs
- tools
- chemicals



LED TRAILER LIGHT KITS

EACH ITEM SHOWN HERE CAN BE PURCHASED SEPARATELY



FEATURES:

- **EASE OF REPLACEMENT / RETROFIT** - Optronics **LED** market clearance lights utilize standard 2-wire molded plugs used for regular incandescent lighting. Our **LED** stop/turn/tail lights utilize standard 3-wire plugs. No special wires or plugs needed. retrofit with ease!
- **FULL 3 YEAR WARRANTY FROM DATE OF PURCHASE** - All Optronics **LED** lighting products are covered under a 3 year warranty. Optronics will repair or replace defective products.
- **NEW! SUPER DIODES** - Selected Optronics **LED** Stop / turn / tail lights manufactured using powerful Super Diodes - 3X as bright as standard diodes. In addition, super diodes offer almost twice the angle of light as standard diodes. A brighter **LED!**

WATERPROOF LED AEROPRO OVER 80" COMBINATION TAIL LIGHT KIT



Universal mount stop/turn/tail lights. All- weather molded plastic housing. Kit includes 2 **LED** lights, 2-wire 25' wishbone wire harness, and 2 clearance lights. Clamshell packaged.

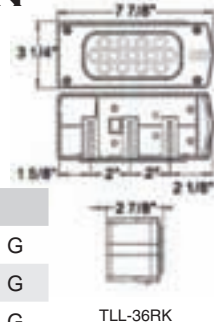

PART #	DESCRIPTION	DIODES		
OP1130	Light Kit (As Shown)	----	112.75	G
OP1136	6 Function LED Right Side Tail Light	17	42.80	G
OP1137	7 Function LED Left Side Tail Light	23	46.95	G
OP917	Clearance Lights	----	4.60	H
OP250	25' Wire Harness (Wishbone)	----	17.35	G

WATERPROOF OVER 80" COMBINATION LED TAIL LIGHT KIT



Universal mount stop/turn/tail lights. All- weather molded plastic housing. Kit includes 2 **LED** stud mount tail light with red side markers/reflectors, license bracket, 25-ft wiring and harness. Clamshell packaged.



PART #	DESCRIPTION	DIODES		
OP1102	Light Kit (As Shown)	----	97.75	G
OP1114	6 Function LED Right Side Tail Light	18	41.45	G
OP1115	7 Function LED Left Side Tail Light	22	45.50	G
OP250	25' Wire Harness (Wishbone)	----	17.35	G

WATERPROOF UNIVERSAL UNDER 80" COMBINATION LED TAIL LIGHT KIT



Under 80" wide unit. Inc. 2 **LED** stud mounted tail lights with real side markers/reflectors, license bracket, 25-ft wiring harness. Clamshell packaged.

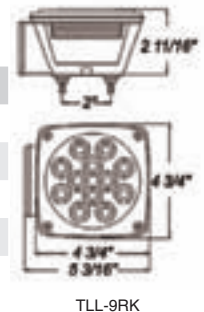

PART #	DESCRIPTION	DIODES		
OP1100	Light Kit (As Shown)	----	91.30	G
OP1110	6 Function LED Right Side Tail Light	16	37.45	G
OP1111	7 Function LED Left Side Tail Light	21	41.45	G
OP250	25' Wire Harness (Wishbone)	----	17.35	G

REPLACEMENT LENSES FOR ABOVE LIGHTS



- No bulbs to replace...EVER!
- Brighter than standard, conventional bulbs
- Side marker lights are built in
- 100% sealed, waterproof stop, turn, tail lights

PART #	DESCRIPTION		
OP460	Replacement Lens for OP1114	4.90	G
OP461	Replacement Lens for OP1115	0.90	J
OP462	Replacement Tail Light Lens for OP1110	2.75	G
OP464	Replacement Tail Light Lens w/Gasket for OP1111	5.65	G



- tires & wheels
- axles, hubs & springs
- tongue accessories
- hitches
- electrical
- brake parts
- trailer hardware
- locks & pins
- towing & loading
- tie downs
- tools
- chemicals

TRAILER



- tires & wheels
- axles, hubs & springs
- tongue accessories
- hitches
- electrical
- brake parts
- trailer hardware
- locks & pins
- towing & loading
- tie downs
- tools
- chemicals

MARKER/CLEARANCE LIGHTS

SQUARE REFLECTOR MARKER/CLEARANCE LIGHTS



Square clearance or side marker light with a reflectorized lens, eliminating the need for a separate reflector to meet DOT requirements. Single wire design grounds through mounting stud. Features replaceable lens and easy to change replaceable bulb (#GE194). All-weather molded plastic housing and durable lens to protect against corrosion. Amber or red. Available in colorful retail packaging.

PART #	MFG #	DESCRIPTION		
OP367	MC-36AS	Amber	4.55	G
OP368	MC-36RS	Red	4.55	G

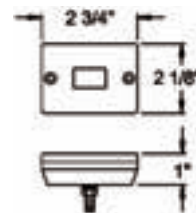

SEALED RECTANGULAR MARKER/CLEARANCE LIGHTS



Mini thin-line rectangular clearance or side marker light. PC-Rated light that functions as both a clearance and side marker light when properly mounted on a 45 degree angle. Features sonically sealed, waterproof lens and housing in a single unit. MC-91 kits include the A-91 light and A-91CB chrome base.

PART #	MFG #	DESCRIPTION		
OP917	MC-91AS	Amber	4.60	H
OP918	MC-91RS	Red	4.60	H

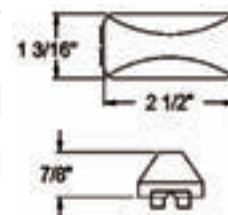

DOUBLE BULLSEYE MARKER/CLEARANCE LIGHTS



Dual bulb, bullseye marker/clearance light with black base. Two-bulb design optimizes light output. Features snap-on, replaceable lens and easy to change replaceable bulbs (#GE194). All-weather molded plastic housing and durable lens protect against corrosion. Mounts on industry standard 3" centers. Amber or red. Available in colorful retail packaging.

PART #	MFG #	DESCRIPTION		
OP470	MC-42AS	Amber	4.35	H
OP471	MC-42RS	Red	4.35	H

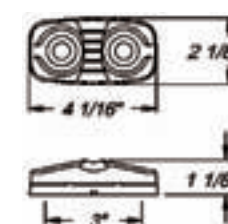

2.5" ROUND SIDE MARKER/CLEARANCE LIGHTS



Round clearance or side marker light for surface mount. PC-Rated light that functions as both a clearance and side marker light when properly mounted on a 45 degree angle. All-weather molded plastic housing and durable lens protect against corrosion. Single wire design grounds through mounting hardware. Features snap-on, replaceable lens and easy to change replaceable bulb (#GE194). Amber or red. Available in colorful retail packaging.

PART #	MFG #	DESCRIPTION		
OP472	MC-58AS	Amber	3.60	G
OP473	MC-58RS	Red	3.60	G

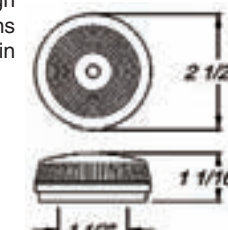



MARKER/CLEARANCE LIGHTS

OBLONG REFLECTOR MARKER/CLEARANCE LIGHTS



- Oblong clearance or side marker light with reflectorized lens, which meets DOT requirements
- Ear-mount black base
- All weather molded plastic housing to protect against corrosion

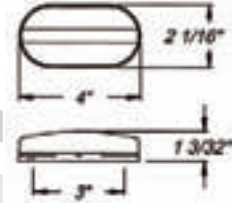

PART #	MFG #	DESCRIPTION		
OP377	MC-31AS	Amber	3.60	G
OP378	MC-31RS	Red	3.60	G

SEALED STUD MOUNT MARKER/CLEARANCE LIGHTS



- Stud mount clearance or side marker light features sonically sealed, waterproof lens and housing in a single unit
- Single wire design grounds through mounting stud

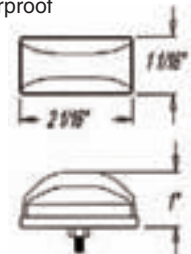

PART #	MFG #	DESCRIPTION		
OP385	MC-95AS	Amber	4.50	G
OP386	MC-95RS	Red	4.50	G

RECTANGULAR REFLECTOR MARKER/CLEARANCE LIGHTS

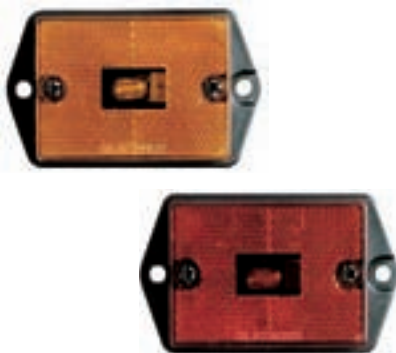

- Rectangular clearance or side marker light with reflectorized lens, which meets DOT requirements
- Ear-mount black base
- All weather molded plastic housing to protect against corrosion

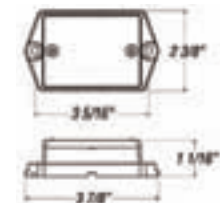

PART #	MFG #	DESCRIPTION		
OP373	MC-35AS	Amber	4.90	G
OP375	MC-35RS	Red	4.90	G

FLUSH MOUNT MARKER/CLEARANCE LIGHTS



- Flush mount clearance or side marker light with chrome trim
- Design includes both lead and ground wires for mounting to all surfaces

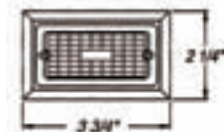

PART #	MFG #	DESCRIPTION		
OP380	MC-71AS	Amber	5.10	G
OP381	MC-71RS	Red	5.10	G

- tires & wheels
- axles, hubs & springs
- tongue accessories
- hitches
- electrical**
- brake parts
- trailer hardware
- locks & pins
- towing & loading
- tie downs
- tools
- chemicals

TRAILER



MARKER/CLEARANCE LIGHTS

- tires & wheels
- axles, hubs & springs
- tongue accessories
- hitches
- electrical
- brake parts
- trailer hardware
- locks & pins
- towing & loading
- tie downs
- tools
- chemicals



CHROME PLATED MARKER/CLEARANCE LIGHTS

- Clearance or side marker light features snap-on, replaceable lens
- Single wire design grounds through mounting hardware

PART #	MFG #	DESCRIPTION		
OP383	MC-81AS	Amber	6.00	G
OP384	MC-81RS	Red	6.00	G

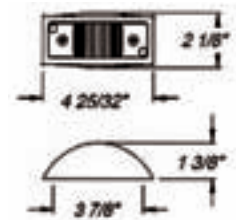

MINI MARKER/CLEARANCE LIGHTS

- Mini rectangular light with durable plastic base with external mounting holes
- Single wire design grounds through mounting screw

PART #	MFG #	DESCRIPTION		
OP370	MC-11AS	Amber	2.80	G
OP371	MC-11RS	Red	2.80	G

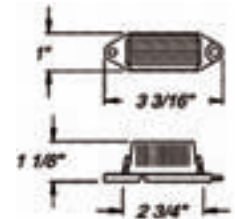

ELEVATED MARKER/CLEARANCE LIGHT ASSEMBLIES WITH REFLEX

- Kit includes surface mount bracket with sealed marker light and reflector ready to install
- PC-Rated light fulfills P2 function when properly mounted on a 15 degree angle

PART #	MFG #	DESCRIPTION		
OP388	MC-61RB	Amber	6.40	G

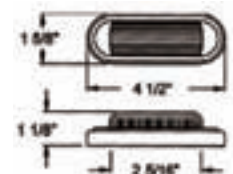



UNIVERSAL STOP/TURN/TAIL LIGHTS

UNIVERSAL STUD MOUNT STOP/TURN/TAIL/BACK-UP & LICENSE LIGHTS



Universal stud-mount stop, turn, tail, back-up and license light. Features screw-on, replaceable lens and easy to change replaceable bulbs. Shock proof socket guarantees long bulb life. All-weather molded plastic housing and durable lens protect against corrosion. Surface mount with three 1/4" studs. Grounds through mounting studs. Available in both bulk and colorful retail packaging.

PART #	MFG #	DESCRIPTION		
OP1120	ST-60RS	Display Packaged	17.45	J
OP1122	ST-60RS	Bulk	13.20	G
OP1124	AR60RB	Repl. Lens	2.35	H

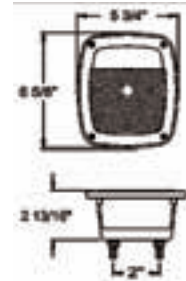

6" OVAL STOP/TURN/TAIL LIGHT FOR FLUSH MOUNT



Sealed red stop/turn/tail light for flush mount. Features sonically sealed, waterproof lens and housing in a single unit. Shock proof socket guarantees long bulb life. Complete with grommet (PM42118) and 3 wire plug (PM431491). Available in colorful retail packaging.

PART #	MFG #	DESCRIPTION		
OP708	ST070RK	Red	11.30	G

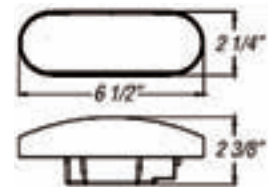

4-3/4" ROUND STOP/TURN/TAIL LIGHTS



4-3/8" round stop/turn/tail lights with black polymer housings. Mounts with two 1/4" studs on 2" centers. Features plastic housing, snap-on replaceable lens and easy to change replaceable bulb (#GE1034/GE2057). Available in both bulk and colorful retail packaging.

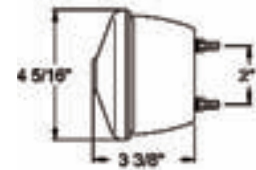

ST-25RB

BULK				PACKAGED				
PART #	MFG #			PART #	MFG #		DESCRIPTION	
OP1126	ST24RB	4.85	G	OP1116	ST20RS	6.95	G Left Side	
OP1127	ST25RB	5.10	G	OP1117	ST21RS	7.30	G Right Side	
OP1129	A-24RB	1.65	H	OP1129	A-24RB	1.65	H Repl. Lens	

- tires & wheels
- axles, hubs & springs
- tongue accessories
- hitches
- electrical
- brake parts
- trailer hardware
- locks & pins
- towing & loading
- tie downs
- tools
- chemicals

TRAILER



TRAILER LIGHTING

- tires & wheels
- axles, hubs & springs
- tongue accessories
- hitches
- electrical**
- brake parts
- trailer hardware
- locks & pins
- towing & loading
- tie downs
- tools
- chemicals

LED 6" OVAL S/T/T KIT WITH GROMMET & PLUG

- Includes grommet
- 'TRY ME' packaging
- Polycarbonate lenses and housing are sonic welded
- Grommet mount

PART #	MFG #	DESCRIPTION		
989025	C561RTM	GROMMET & PLUG	13.95	E
989027	C563RTM	SURFACE MOUNT	17.95	E



989025

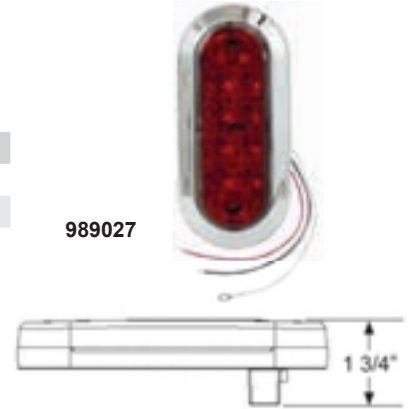
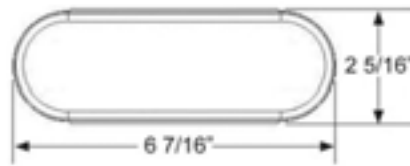

989027

LED 6" OVAL PARK/TURN (AMBER) KIT WITH GROMMET & PLUG

- Includes grommet
- 'TRY ME' packaging
- Polycarbonate lenses and housing are sonic welded
- Grommet mount

PART #	MFG #	DESCRIPTION		
989026	C561ATM	GROMMET & PLUG	13.95	E



989026

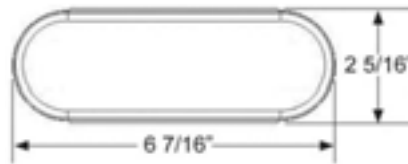

LED UNIVERSAL S/T/T

- Includes Light only
- 'TRY ME' Packaging
- Polycarbonate housing and acrylic lens are sonically welded to create full sealed light
- 6 functions - Stop/Tail/Turn, Rear, Reflex, Back-up, and License Illuminator
- Industry standard 3 stud mounting pattern on 2" centers
- S/T/T 16 diodes, Back-up 18 diodes, License Illuminator 5 diodes
- 39 Diodes

PART #	MFG #	DESCRIPTION		
989028	C599SWTM	UNIVERSAL S/T/T	60.95	E

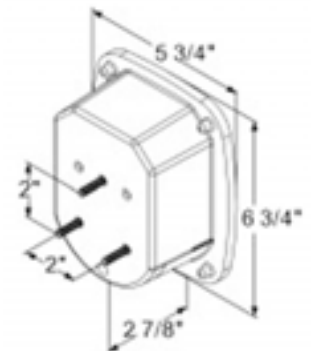

NEW
PRODUCT

TRAILER LIGHTING

LED SLIM PROFILE S/T/T WITH CHROME BEZEL

- Includes Light with chrome bezel
- Ideal use on boat trailers
- STI approved
- 9 Diode



PART #	MFG #	DESCRIPTION		
989029	C561ATM	SLIM PROFILE S/T/T	22.95	E

LED LOW PROFILE OVER/UNDER 80" S/T/T LIGHT PASSENGER SIDE

- Includes Light with chrome bezel
- Ideal use on boat trailers
- STI approved
- 9 Diode

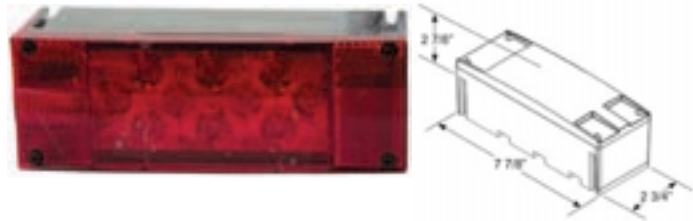

PART #	MFG #	DESCRIPTION		
989031	C7298TM	LOW PROFILE S/T/T	22.95	E

LED COMBO UNDER 80" S/T/T LIGHTS

- Includes Light with chrome bezel
- Ideal use on boat trailers
- STI approved
- 9 Diode



PART #	MFG #	DESCRIPTION		
989032	C7483RTM	LED COMBO S/T/T DRIVER'S SIDE	20.95	E
989033	C7493RTM	LED COMBO S/T/T PASSENGER'S SIDE	17.95	E

LED CLEAR LENS SUBMERSIBLE TRAILER LIGHT KIT

- Includes Complete kit
- Clear Lens with red LEDs
- Contents: 2 submersible stop/tail/turn LED lights, wiring harness, license plate bracket, mounting hardware and complete trilingual instructions
- Left hand side has 21 Diodes
- Right hand side has 16 Diodes



PART #	MFG #	DESCRIPTION		
989034	C5721	SUBMERSIBLE KIT	70.95	E

tires &
wheelsaxles, hubs
& springstongue
accessories

hitches

electrical

brake
partstrailer
hardwarelocks &
pinstowing &
loading

tie downs

tools

chemicals

TRAILER



TRAILER LIGHTING

- tires & wheels
- axles, hubs & springs
- tongue accessories
- hitches
- electrical**
- brake parts
- trailer hardware
- locks & pins
- towing & loading
- tie downs
- tools
- chemicals

LED WIRELESS TOWING LIGHT KIT

- Includes Complete kit
- Effective transmitter distance of 65'
- Contents: 2 stop/tail/turn LED lights, transmitter with standard flat 4 wire vehicle trailer light connector and complete trilingual instructions
- 10 Diodes per light
- Patent Pending



PART #	MFG #	DESCRIPTION		
989035	C5721	SUBMERSABLE KIT	131.95	E

LED LOW PROFILE TRAILER LIGHT KIT OVER/UNDER 80"

- Includes Complete kit
- 'TRY ME' Packaging
- Low profile design
- Contents: 2 submersible stop/tail/turn LED lights, wiring harness, license plate bracket, mounting hardware and complete trilingual instructions
- Left hand side has 14 Diodes
- Right hand side has 11 Diodes



PART #	MFG #	DESCRIPTION		
989036	C7280	LOW PROFILE LIGHT KIT	53.95	E

LED TRAILER LIGHT KIT - SUBMERSIBLE - UNDER 80"

- Includes Complete kit
- 'TRY ME' Packaging
- Low profile design
- Contents: 2 submersible stop/tail/turn LED lights, wiring harness, license plate bracket, mounting hardware and complete trilingual instructions
- Left hand side has 14 Diodes
- Right hand side has 11 Diodes



PART #	MFG #	DESCRIPTION		
989037	C7423	LED TRAILER LIGHT KIT	51.95	E

TRAILER



TRAILER LIGHTING

- tires & wheels
- axles, hubs & springs
- tongue accessories
- hitches
- electrical
- brake parts
- trailer hardware
- locks & pins
- towing & loading
- tie downs
- tools
- chemicals

LED LICENSE/UTILITY LIGHT

- Includes Light and mounting hardware included
- Chrome plated housing
- Frosted lens
- Hooded design reduces glare
- Works with 12V systems
- DOT Compliant
- Stud mount installation
- Ideal for foreign cars, vans, trucks, and custom trailers
- 2 LEDs - No bulb changes

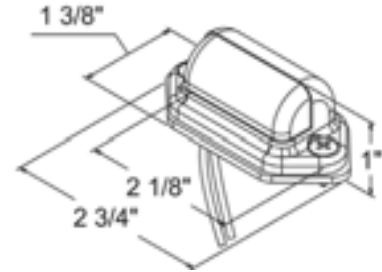

PART #	MFG #	DESCRIPTION		
989039	B168	LED LICENSE/UTILITY LIGHT	7.95	E

LED LOW PROFILE MAGNETIC MOUNT STROBE/BEACON LIGHT

- 32 amber LED
- Polycarbonate lens for superior performance in all weather conditions
- Change among 8 flash patterns with just a push of a button
- Heavy-duty magnetic base
- LED provides lower current draw compared to traditional incandescent and halogen bulbs
- Includes 12 ft. power cord, plug with on/off switch



PART #	MFG #	DESCRIPTION		
989040	C38CAW	LED LOW PROFILE STROBE	76.95	E

LED 4" SQUARE WORK / UTILITY LIGHT MAGNETIC BASE

- Includes Light and Installation Kit
- Aluminum die-case housing and polycarbonate lens
- five 3W high output LEDs
- 12' 12 volt power cord, and magnetic base



PART #	MFG #	DESCRIPTION		
989040	CWL535	SQUARE WORK / UTILITY	76.95	E

TRAILER



TRAILER LIGHT KITS

UNIVERSAL LOW PROFILE SUBMERSIBLE OVER 80" WIDE TRAILER LIGHT KIT

Over 80" submersible rear lighting kit for all trailers - includes rear legal tail lighting and reflectors for trailers over 80" wide (PM456/4561 tail light) 25' trailer harness, 48" trunk connector, license bracket, mounting hardware. NOTE: front side lights, reflectors, rear I.D. bar are necessary to meet DOT requirements.



PART #	MFG #	DESCRIPTION		
PM547	V547	Submersible Light Kit	59.95	G
REPLACEMENT PARTS FOR PM547				
PM456	M456	7-Way Tail Light RH	17.95	G
PM4561	M456L	8-Way Tail Light LH	17.95	G
PM5425	V5425Y	25' Wire Harness	25.95	G

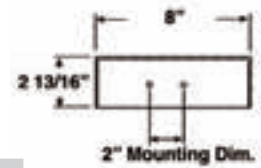

UNIVERSAL SUBMERSIBLE OVER 80" WIDE TRAILER LIGHT KIT

Kit provides rear lighting and reflectors for trailers over 80" wide. Includes 2 tail lights, 25' trailer harness, 48" trunk connector, license bracket, mounting hardware, and installation instructions.



PART #	MFG #	DESCRIPTION		
PM544	V544	Submersible Light Kit	45.95	G
REPLACEMENT PARTS FOR PM544				
PM452	V452	7-Way Tail Light RH	14.95	G
PM4521	V452L	8-Way Tail Light LH	14.95	G
PM5425	V5425Y	25' Wire Harness	25.95	G
PM44015	440-15	Repl Rear Lens	3.95	G
PM5615	55-15R	Repl Side Lens	3.95	G

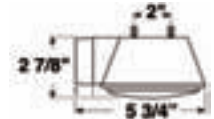

UNIVERSAL UNDER 80" WIDE TRAILER LIGHT KIT

This kit provides all legal lighting and reflective equipment for any trailer less than 80" wide. It includes 2 tail lights, 20' wire harness, 2 side marker lights, 48" trunk connector, plastic license bracket, mounting hardware, and installation instructions.



PART #	MFG #	DESCRIPTION		
PM540	V540	Trailer Light Kit	59.95	G
REPLACEMENT PARTS FOR PM540				
PM440	V440	7-Way Taillight RH	9.95	G
PM444	V440L	8-Way Tail Light LH	9.95	G
PM114	V114A	Clearance Light	5.95	G
PM5425	V5425Y	25' Wire Harness	25.95	G
PM44015	440-15	Repl Rear Lens	3.95	G
PM5515	55-15R	Repl Side Lens - Red	3.95	G
PM5516	55-15A	Repl Side Lens - Amber	3.95	G

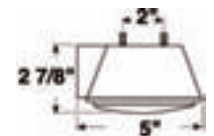

REPLACEMENT TAIL LIGHTS & LENSES

- WRAP AROUND • 5-IN-1 TAIL LAMP
- STOP-TAIL-TURN • SIDE MARKER REFLECTOR



MN9091
LENS ONLY



MN9090
LENS ONLY

PART #	MFG #	DESCRIPTION		
MN5236	52362-3	LH Tail Light Assembly	23.95	G
MN5237	52372-3	RH Tail Light Assembly	23.95	G
GE1034	1157	Replacement Rear Bulb	0.50	L
GE1895	57	Replacement Side Bulb	0.50	L

Red Replacement Lenses for **MN5236** and **MN5237** tail lights. Combination rear lamp for in-frame mounting - as used on many trailers: snowmobile, utility, etc.



STOP, TURN, & TAIL LIGHTS

UNDER 80" WIDE COMBINATION TAIL LIGHTS



• Under-80" combination tail light. Includes the following functions: stop, turn, tail, rear reflex, side marker, side reflex, and license light (PM444 only) • Mounts on 2" centers and includes mounting hardware • Grounds through 1/4" mounting studs • These lights also replace lights on PM540 and PM541 light kits

PART #	MFG #	DESCRIPTION		
PM440	V440	6 Function RH	9.95	G
PM444	V440L	7 Function LH	9.95	G
PM44015	440-15	Rear Replacement Lens	3.95	G
PM5515	55-15R	Side Replacement Lens	3.95	G



V440

OVER 80" WIDE SUBMERSIBLE COMBINATION TAIL LIGHTS



• Under-80" combination tail light. Includes the following functions: stop, turn, tail, rear reflex, side marker, side reflex, and license light (PM4521 only) • Mounts on 2" centers and includes mounting hardware • Grounds through mounting studs • These lights also replace lights on PM544 light kit

PART #	MFG #	DESCRIPTION		
PM452	V452	6 Function RH	13.95	G
PM4521	V452L	7 Function LH	7.95	G
PM44015	440-15	Rear Replacement Lens	3.95	G
PM5615	56-15R	Side Replacement Lens	3.95	G

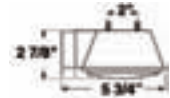

V452

OVER 80" WIDE SUBMERSIBLE COMBINATION TAIL LIGHTS



• Low-profile, over-80" submersible combination tail light • Includes the following functions: stop, turn, tail, rear clearance, rear reflex, side marker, side reflex, and license light (PM4561 only) • Grounds through separate lead wire • Mounts on slide-on 2" centers and includes mounting hardware • These lights also replace lights on PM547 light kit

PART #	MFG #	DESCRIPTION		
PM456	M456	6 Function RH	17.95	G
PM4561	M456L	7 Function LH	17.95	G

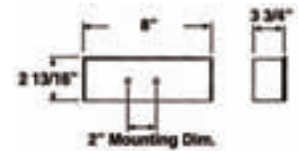

V456

SEALED ROUND 4" STOP, TURN, & TAIL LIGHT



• Sealed, 4" round stop, turn, and tail light may be used on both curbside and roadside of vehicle or trailer • Features extra wide, spin welded, tongue-and-groove lens lip and waterproof seal • Can be purchased as a kit with grommet and 3 wire plug or each piece can be purchased separately.

PART #	MRF #	DESCRIPTION		
PM4260	Y426KR	Light Kit	13.95	G
PM426	426R	Light Only	7.95	G
PM42618	426-18	Grommet Only	3.95	G
PM431491	431-491	3-Wire Plug Only	3.95	G

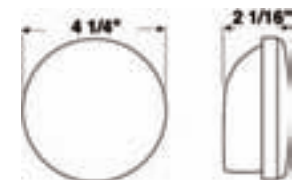

V426R

SEALED OVAL STOP, TURN, & TAIL LIGHT



• Sealed, oval stop, turn, and tail light may be used on both curbside and roadside of vehicle or trailer • Legal in either horizontal or vertical position • Polycarbonate lens is welded to housing to form single unit • Can be purchased as a kit with grommet and 3 wire plug or each piece can be purchased separately.

PART #	MFG #	DESCRIPTION		
PM4210	V421KR	Light Kit	12.95	G
PM421	V421R	Light Only	9.95	G
PM42118	421-18	Grommet Only	3.95	G
PM431491	431-491	3-Wire Plug Only	3.95	G

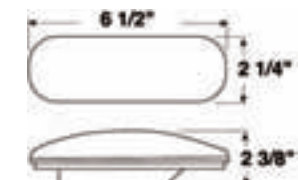

V421R

UNIVERSAL MOUNTING BRACKET



• Black powder-coat finish
• 3" wide x 4-1/2" tall
• For use with most Peterson stud mount lights

PART #	MFG #	DESCRIPTION		
PM5109	510-9	Black Steel - Bulk	4.95	G

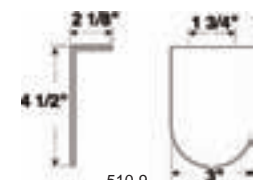

510-9

- tires & wheels
- axles, hubs & springs
- tongue accessories
- hitches
- electrical
- brake parts
- trailer hardware
- locks & pins
- towing & loading
- tie downs
- tools
- chemicals

TRAILER



CLEARANCE & SIDE MARKER LIGHTS

CLEARANCE/SIDE MARKER LIGHT W/REFLEX

• Stud-mount light functions as side marker or clearance light with built-in reflective optics; eliminates need for separate reflector • Just push stripped power into "Quick Lock" port to connect • May be used as a combination side marker and clearance light for over 80" applications when properly mounted • Features 15,000-hour long life bulb • Available in amber or red

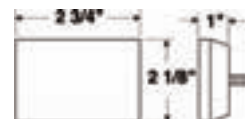

PART #	MFG #	DESCRIPTION		
PM114	V114A	Amber Light	5.95	G
PM1141	V114R	Red Light	5.95	G
PM1140	114-15A	Amber Replacement Lens	2.95	G
PM1145	114-15R	Red Replacement Lens	2.95	G
GE194	194	Replacement Bulb	0.50	L

DOUBLE BULLS-EYE CLEARANCE AND SIDE MARKER LIGHT

• Popular, two-bulb lamp that functions as clearance or side marker light, and may be used as combination clearance and side marker when properly mounted • Acrylic lens snaps onto housing Surface mounts on 3" centers and grounds through mounting hardware; single wire for electrical connection • Features two 15,000-hour long life bulbs • Available in amber or red

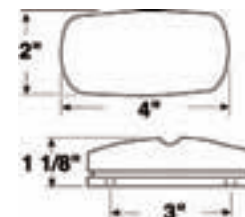

PART #	MFG #	DESCRIPTION		
PM1381	V138A	Amber Light	4.95	G
PM138	V138R	Red Light	5.95	G
PM1385	V138-15A	Amber Replacement Lens	4.95	G
PM1380	V138-15R	Red Replacement Lens	4.95	G
GE194	194	Replacement Bulb	0.50	L

COMBINATION 1-BULB LIGHT W/REFLEX

• Acrylic lens features built-in reflector and precision optics for brilliant signal; no separate reflector needed • Includes durable, molded base with single-bulb socket and single lead wire; grounds through mounting screw • Available in amber or red.

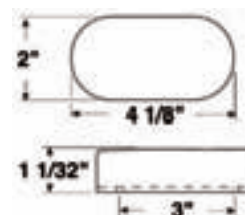

PART #	MFG #	DESCRIPTION		
PM1081	108WA	Amber Light	4.95	G
PM108	108WR	Red Light	4.95	G
PM10816	108-15A	Amber Replacement Lens	2.95	G
PM10815	108-15R	Red Replacement Lens	2.95	G
GE194	194	Replacement Bulb	0.50	L

OBLONG CLEARANCE/SIDE MARKER LIGHTS

• Thin-line, surface-mount lamp features high impact base with scratch resistant acrylic lens • May be mounted horizontally or vertically • Includes single lead wire and grounds through mounting screw • Available in amber or red

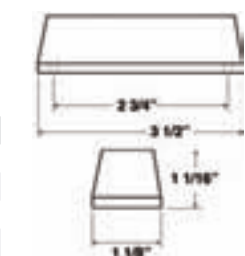

PART #	MFG #	DESCRIPTION		
PM136	V136A	Light Only - Amber	5.95	G
PM1361	V136R	Light Only - Red	5.95	G
PM1365	136-15A	Lens Only - Amber	2.95	G
PM1366	136-15R	Lens Only - Red	2.95	G

2" CLEARANCE AND SIDE MARKER LIGHT

• Functions as side marker or clearance light • May be used as combination side marker and clearance light when properly mounted • Features sealed lens and housing • Light comes without flange for use with rubber grommet • Requires 2-wire plug to complete installation • Features 15,000-hour long life bulb • Kit includes grommet (# PM14618) and plug (# PM14249) • Available in amber or red



PART #	MFG #	DESCRIPTION		
PM1461	146A	Amber Light	3.95	G
PM146	146R	Red Light	3.95	G
PM14618	146-18	Grommet Only	2.95	G
PM14249	142-49	Plug Only	3.95	G

tires & wheels
axles, hubs & springs
tongue accessories
hitches
electrical
brake parts
trailer hardware
locks & pins
towing & loading
tie downs
tools
chemicals

TRAILER



CLEARANCE & SIDE MARKER LIGHTS

MINI-LITES (EAR MOUNT)



- Amber or red lights functions as clearance, side marker or identification light and may be used as combination side marker and clearance light when properly mounted
- Features durable base with external mounting holes
- Lens snap-locks onto base
- Includes single lead wire and grounds through mounting screw.

PART #	MFG #	DESCRIPTION		
PM1070	V107WR	Light Only - Red	4.95	G
PM1071	V107WA	Light Only - Amber	4.95	G
PM7150	107-15R	Lens Only - Red	2.95	G
PM7151	107-15A	Lens Only - Amber	2.95	G
GE194	194	Replacement Bulb	0.50	L

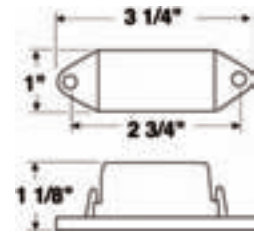

V107WR

SEALED CLEARANCE AND SIDE MARKER LIGHTS

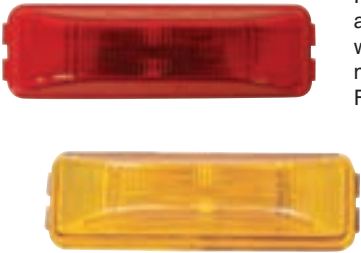

Functions as side marker or clearance light • When mounted at a 45 degree angle, light may be used as combination clearance and side marker • Lens is welded to housing to form single unit • Mounting screw serves as ground when mounted to metallic surface with single lead wire for electrical connection • Features two 15,000-hour long life bulbs • Available in amber or red.

PART #	MFG #	DESCRIPTION		
PM154	154A	Light Only - Amber	4.95	G
PM155	154R	Light Only - Red	4.95	G
PM15409	154-09K	Bracket - Gray	7.95	G
PM15410	154-10K	Bracket - Chrome	7.95	G
PM15411	154-11K	Bracket - Black	7.95	G

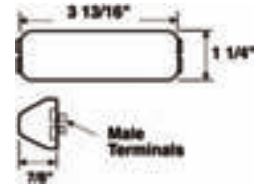

V154R



BACK-UP LIGHTS

SEALED OVAL BACK-UP LIGHT



- Sealed, oval back-up light meets DOT requirement in either horizontal or vertical position
- Polycarbonate lens is sonic welded to housing to form single unit
- Kit includes light, grommet (# PM42118), and plug (# PM14249)

PART #	MFG #	DESCRIPTION		
PM4165	416K	Clear Light Kit	14.95	G
PM42118	421-18	Grommet Only	3.95	G
PM14249	142-49	Plug Only	3.95	G

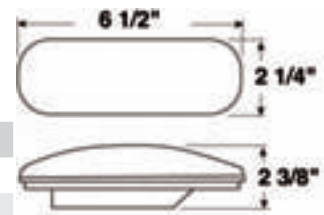

416K

SEALED ROUND 4" BACK-UP LIGHT



- Features extra wide, spin-welded, tongue-and-groove lens lip and waterproof seal
- High performance, copper alloy conductors eliminate the possibility of wire failure
- State-of-the-art bulb design features three supports for the minor filament and two supports for the major filament providing long bulb life
- Wedge-base socket prevents premature bulb failure
- Kit includes light, grommet (# PM42618) and plug (# PM43149)

PART #	MFG #	DESCRIPTION		
PM415	415K	Clear Light Kit	14.95	G
PM42618	426-18	Grommet Only	3.95	G
PM43149	431-49	Plug Only	4.95	G

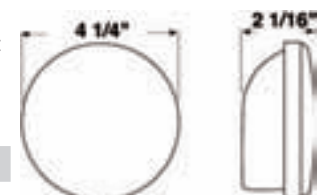

415K

- tires & wheels
- axles, hubs & springs
- tongue accessories
- hitches
- electrical
- brake parts
- trailer hardware
- locks & pins
- towing & loading
- tie downs
- tools
- chemicals

TRAILER

- tires & wheels
- axles, hubs & springs
- tongue accessories
- hitches
- electrical
- brake parts
- trailer hardware
- locks & pins
- towing & loading
- tie downs
- tools
- chemicals



LIGHT BARS

SEALED SUBMERSIBLE "ID" LIGHT BAR FOR OVER 80" APPLICATIONS



• Submersible identification bar light for over 80" applications • Black polycarbonate bar is corrosion-proof with three 150 sealed lights attached • 150 Lights snap on/off for easy service • Mounts on 16" centers • Includes three-plug harness with two lead wires.

PART #	MFG #	DESCRIPTION		
PM1503	150-3R	Bar w/3 Lights - Amber	21.95	G
PM150	V150R	Replacement Light - Red	5.95	G

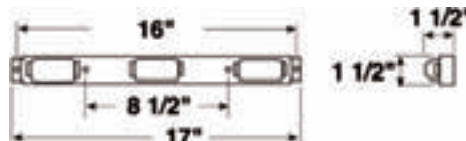

THIN LINE "ID" LIGHT BARS FOR OVER 80" APPLICATIONS



• Identification bar light for over-80" applications • Corrosion resistant bar is 24-gauge steel with black enamel finish and three 136 oval lights attached • Mounts on 6-15/16" centers • Includes single lead wire, and grounds through mounting hardware • Available in amber or red.

PART #	MFG #	DESCRIPTION		
PM13650	136-3A	Amber Light Bar	15.95	G
PM13660	136-3R	Red Light Bar	16.95	G
PM136	V136A	Light Only - Amber	5.95	G
PM1361	V136R	Light Only - Red	5.95	G
PM1365	136-15A	Replacement Lens - Amber	2.95	G
PM1366	136-15R	Replacement Lens - Red	2.95	G
GE194	194	Replacement Bulb	0.50	L

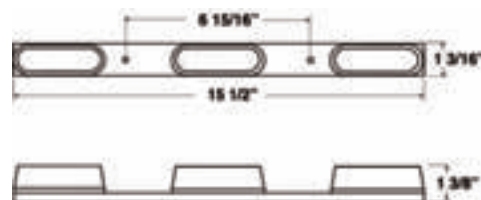

MINI "ID" LIGHT BAR FOR OVER 80" APPLICATIONS



• Economical identification bar light for over 80" applications • Corrosion-resistant bar is power-coated white with three 107 lights attached • Mounts on 16-1/8" centers and grounds through mounting hardware • Available in red only.

PART #	MFG #	DESCRIPTION		
PM1073	107-3R	Red Light Bar	14.95	G
PM1070	V107WR	Light Only - Red	4.95	G
PM7150	107-15R	Replacement Lens Only	2.95	G
GE194	194	Replacement Bulb	0.50	L



TRAILER



SPITFIRE® REFLECTOR KIT



50% wider reflectivity angle than conventional reflectors. Kit contains 2 each round 2-7/8" diameter, 2 each rectangular 2-3/4" x 1-1/4", 2 each rectangular 4-5/16" x 1-11/16", all red, in attractive, self-service visual packaging.

PART #	MFG #	DESCRIPTION		
PM493	V493KR	Spitfire Reflector Kit	11.95	G



2-WIRE PLUGS



- 2-wire molded plugs for single contact sealed incandescent stop/turn or backup lamps
- Includes #10 ring terminal on ground wire; hot wire is stripped
- Available with straight or right angle plug
- Poly bagged

PART #	MFG #	DESCRIPTION		
PM43149	431-49	Straight, 10-1/2"	4.95	G
PM42149	421-49	Right Angle, 10-1/2"	3.95	G

3-WIRE PLUGS



- 3-wire molded plugs for double contact sealed incandescent stop/turn or backup lamps
- Includes #10 ring terminal on ground wire; hot wire is stripped
- Available with straight or right angle plug
- Poly bagged

PART #	MFG #	DESCRIPTION		
PM431491	431-491	Straight, 10-1/2"	3.95	G
PM421491	421-491	Right Angle, 10-1/2"	3.95	G

OVAL GROMMET

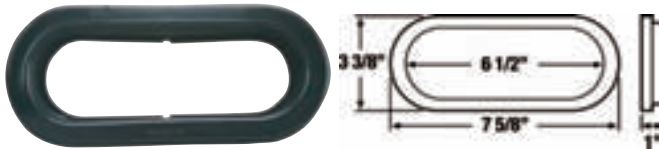

- Black PVC grommet flush mounts oval style lamps
- Provides additional shock absorption to extend lamp life

PART #	MFG #	DESCRIPTION		
PM42118	421-18	Oval Grommet	3.95	G

2" GROMMET



- Allows 2" diameter sealed units to be flush mounted
- Fits 2-5/16" mounting hole
- Provides additional shock absorption to extend lamp life

PART #	MFG #	DESCRIPTION		
PM14618	146-18	2" Grommet	2.95	G

4" GROMMET



- Black PVC grommet flush mounts 4" diameter round lamps in 4-1/2" hole
- Provides additional shock absorption to extend lamp life

PART #	MFG #	DESCRIPTION		
PM42618	426-18	Oval Grommet	3.95	G

MARKER LAMP PLUG



- 2-wire molded plug for clearance and marker lights
- Includes a #10 ring terminal on ground wire; hot wire is stripped
- 6" leads

PART #	MFG #	DESCRIPTION		
PM14249	142-49	Marker Lamp Plug	3.95	G

ELECTRO-MECHANICAL FLASHERS



- 12-lamp, 12-volt flasher
- 70-120 flash rate
- 25.2-amp rating
- Only 1-1/2" tall, fits into small areas with limited access
- Poly bagged

PART #	MFG #	DESCRIPTION		
PM570	570	2 Prong - Medium Duty	16.95	G
PM571	571	3 Prong - Heavy Duty	16.95	G

FLASHER



- Replaces virtually all 12 volt, 2 terminal flashers
- Flashes one to four 32 C.P. standard or long life lamps for turn signals
- Flashes two to eight lamps for hazard warning

PART #	MFG #	DESCRIPTION		
85552	39552-012	Flasher	2.95	E

tires & wheels
axles, hubs & springs
tongue accessories
hitches
electrical
brake parts
trailer hardware
locks & pins
towing & loading
tie downs
tools
chemicals

TRAILER



LIGHTS & LENSES

COMBINATION OVER 80" TAIL LIGHT



Universal 2" on center stud mounting. Screw-on rear and side marker lens for easy bulb replacement. These tail lights are designed for a variety of under 80" wide light duty trailers. Display packaged.



6.09" W x 4.59" H x 2.87" D

PART #	MFG #	DESCRIPTION		
923343	003343	Replacement Side Lens - Amber	1.50	AD

- tires & wheels
- axles, hubs & springs
- tongue accessories
- hitches
- electrical**
- brake parts
- trailer hardware
- locks & pins
- towing & loading
- tie downs
- tools
- chemicals

LIGHTS & LENSES

**CLEARANCE/SIDE MARKER LIGHTS FENDER MOUNT
#40 SERIES**

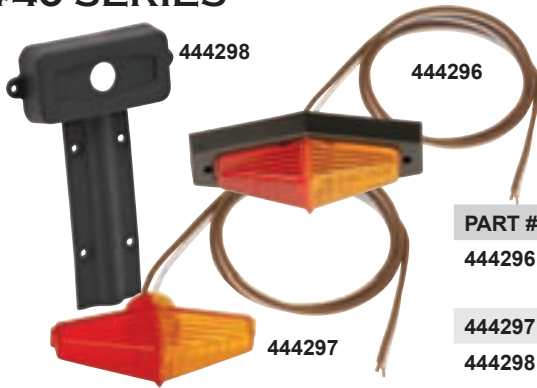

Dual function red/amber light for use on fender mount applications. The bulb is protected by the lens on all sides. Two wire design (24" supply and ground) eliminates surface ground. Light w/black base, stainless steel mounting screws:

3.65" x 1.25" x 1.45" w/.5" depth
Light only: 2.75" x 1" x .85" w/.5" depth
Fender mount bezel only: 7.20" x 4.85" x .85"

PART #	MFG #	DESCRIPTION		
444296	40-40-004	Fender Mount Clearance Light #40 Red/Amber with Lexan Black Base and Mounting Screws	10.94	B
444297	40-40-104	Fender Mount Clearance Light #40 Red/Amber	8.73	B
444298	40-40-115	Fender Mount Bezel	3.06	B

CLEARANCE/SIDE MARKER LIGHT FENDER MOUNT



Surface mount dual function red/amber light with black base for use on fender mount applications. The bulb is protected by the lens on all sides. Two wire design (18" supply and ground) eliminates surface ground.

3.5" x .78" x 1.03"

PART #	MFG #	DESCRIPTION		
444299	40-40-006	Fender Mount Clearance Light #40 Red/Amber with Black Base	3.95	G

WATERPROOF LED HI INTENSITY MICRO CLEARANCE/SIDE MARKER LIGHTS



Waterproof Hi Intensity LED clear, red and amber micro clearance/side marker light. The red and amber lights are FMVSS-108 PC rated. The clear style is ideal for auxiliary and decorative lighting. Self contained grommet and pre-wired with sealed 7" wire pigtail.

.75" light dia. x .5" height, 1" dia. w/grommet

Note: Recommended hole size is .75" and the recommended material thickness is between .0625" and .125".

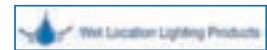

PART #	MFG #	DESCRIPTION		
444293	54201-003	Hi Intensity Micro Clearance Light LED Amber	3.98	B
444294	54201-004	Hi Intensity Micro Clearance Light LED Red	3.98	B
444295	54201-005	Hi Intensity Micro Light LED Clear	4.05	B

MAGNETIC TOW LIGHT KIT W/CARRYING CASE



Universal Tow Light Kit with two Magnetic Base Lights and leads by Wesbarg®. Don't tow around a trailer with malfunctioning lighting. Give yourself and other drivers a break and keep your trailer lighting working properly. Corroded sockets, burned-out bulbs, cracked or missing lenses all should be fixed promptly. Plastic carrying case included.

PART #	MFG #	DESCRIPTION		
928575	18148	Universal Tow Light Kit	73.40	B

- tires & wheels
- axles, hubs & springs
- tongue accessories
- hitches
- electrical
- brake parts
- trailer hardware
- locks & pins
- towing & loading
- tie downs
- tools
- chemicals

TRAILER



LIGHTS & LENSES

COMBINATION UNDER 80" TAIL LIGHTS #80 SERIES



Universal 2" on center stud mounting. Screw-on main and side marker lens allow for easy bulb replacement. This tail light is designed for a variety of under 80" light-duty trailers. Wiring uses the quick connect and disconnect feature. These tail lights meet FMVSS/CMVSS 108 requirements. 4 3/4" x 4 1/2" x 2 9/16"

PART #	MFG #	DESCRIPTION		
444051	2823283	7 Function, Left/Roadside Under 80"	9.80	B
923060	2323284	6 Function, Right/Curbside Under 80"	9.72	B

Complete kit with two tail lights, two amber clearance/side marker lights with reflex lens, 20' or 25' trailer wiring harness cable with molded 4-way flat prong plug, 4' car wiring harness cable with molded 4-way flat prong plug plus license plate bracket.

PART #	MFG #	DESCRIPTION		
444053	2823285	Trailer Light Kit w/25' Wire Harness w/Rectangular Clearance/Side Marker Lights	42.65	B
927500	407500	Trailer Light Kit w/20' Wire Harness w/o Clearance/Side Marker Lights	41.78	B

REPLACEMENT PARTS

PART #	MFG #	DESCRIPTION		
923211	003211	License Plate Bracket	1.90	B
927275	707275	4' Wiring Harness w/4 Way Flat Car End	5.94	B

COMBINATION OVER 80" TAIL LIGHTS #80 SERIES



Universal 2" on center stud mounting. Screw-on main and side marker lens allow for easy bulb replacement. These tail lights meet FMVSS/CMVSS 108 requirements for trailers over 80" wide when properly mounted. Wiring uses the quick connect and disconnect feature. 6.09" x 4.59" x 2.87"

PART #	MFG #	DESCRIPTION		
444054	2823293	8 Function, Left/Roadside Over 80"	12.22	B
444055	2823294	7 Function, Right/Curbside Over 80"	11.68	B

SUBMERSIBLE UNDER 80" TAIL LIGHTS



These lights are ideal for boat and PWC trailers less than 80" wide. Fully gasketed, screw on main and side marker lens allow for easy bulk replacement. Universal 2" on-center stud mount. 5.25" x 4.66" x 3.76" overall height.

PART #	MFG #	DESCRIPTION		
444056	2523073	6 Function, Right/Curbside Submersible Under 80"	10.10	B
444057	2523023	7 Function, Left/Roadside Submersible Under 80"	10.50	B

This kit comes complete with two pre-wired tail lights. 25' trailer wiring harness cable with molded four prong plug, 4' four wire car wiring harness cable with molded 4-way plug plus license plate bracket.

PART #	MFG #	DESCRIPTION		
444050	2527511	Trailer Light Kit w/25' Wire Harness Submersible Under 80"	46.68	B

REPLACEMENT LENSES



REPLACEMENT LENS FOR Wesbarg 80 SERIES TAILLIGHT

PART #		
928580	3.13	B



REPLACEMENT SIDE LENS FOR Wesbarg UNDER 80 SERIES TAILLIGHT

PART #		
928581	0.49	B

- tires & wheels
- axles, hubs & springs
- tongue accessories
- hitches
- electrical
- brake parts
- trailer hardware
- locks & pins
- towing & loading
- tie downs
- tools
- chemicals

TRAILER

LIGHTS & LENSES

SUBMERSIBLE 4X6 OVER 80" TAIL LIGHTS



Unique, compact size and shape allows these lights to fit where space is limited. The lens is sonically-sealed to the base providing a "bell jar", making this lamp fully submersible with easily replaceable bulbs. These lights meet FMVSS/CMVSS 108 requirements for trailers over 80" wide when properly mounted. Pre-wired with molded plugs for easy installation. Size is 6" x 3-1/2" x 2-1/4"

PART #	MFG #	DESCRIPTION		
923075	403075	7 Function, Right/Curbside Submersible 4X6 Over 80"	23.03	B
923025	403025	8 Function, Left/Roadside Submersible 4X6 Over 80"	23.23	B



The kit comes complete with two tail lights, two amber clearance/side marker lights with reflex lens, 20' trailer wiring harness cable with molded four prong plug, 4' four wire car wiring harness cable with molded 4-flat plug plus license plate bracket.

PART #	MFG #	DESCRIPTION		
444048	407515	Trailer Light Kit w/20' Wide Harness Submersible 4X6 Over 80"	57.96	B

REPLACEMENT PARTS

PART #	MFG #	DESCRIPTION		
444041	203117	Clearance/Side Marker, Amber, Stud Mount	7.49	B
444044	003338	Lens Amber, Clearance/Sidemark w/ Screw	2.39	B

SUBMERSIBLE OVER 80" TAIL LIGHTS



These lights are ideal for boat and PWC trailers over 80" wide. Fully gasketed, screw on main and side marker lenses allow for easy bulb replacement. Universal 2" on-center stud mount. These lights meet FMVSS/CMVSS 108 requirements for trailers over 80" wide when properly mounted. Prewired for easy installation. Size is 6.29" x 4.66" x 3.76" overall height.

PART #	MFG #	DESCRIPTION		
444059	2523024	8 Function, Left/Roadside Submersible Over 80"	11.70	B

WATERPROOF 3" X 8" OVER 80" LOW PROFILE TAILLIGHTS



Featuring a reliable waterproof design, these lights have a bulb replaceable capsule that protects the bulbs from corrosion and thermal shock but still allows for easy access for bulb replacement. These lights meet FMVSS/CMVSS 108 requirements for trailers over 80" wide when properly mounted. Size is 8" x 2 7/8" x 2 3/4"

PART #	MFG #	DESCRIPTION		
923076	403076	7 Function, Right/Curbside Waterproof 3X8 Over 80"	13.99	B
923026	403026	8 Function, Left/Roadside Waterproof 3X8 Over 80"	15.94	B

tires & wheels

axles, hubs & springs

tongue accessories

hitches

electrical

brake parts

trailer hardware

locks & pins

towing & loading

tie downs

tools

chemicals

TRAILER



LIGHTS & LENSES

WATERPROOF OVER 80" LOW PROFILE TAILLIGHTS

The kit comes complete with two tail lights, two sealed amber surface mount clearance/side marker lights with reflex lens, 25' trailer wiring harness cable with molded four prong plug, 4' four wire car wiring harness cable with molded 4-way plug plus license plate bracket.



PART #	MFG #	DESCRIPTION		
927509	007509	Trailer Light Kit w/25' Harness Waterproof 3X8 Over 80"	74.39	B

REPLACEMENT PARTS				
PART #	MFG #	DESCRIPTION		
923336	403336	Lens Set Red, 2 tail and 2 Clearance/Side Marker w/Screws	9.74	B
923111	203111	Clearance Light Amber w/Black Stud Mount Base	10.53	B



RECTANGULAR REFLECTORS

Pair of 3.5" adhesive mount rectangular reflectors. Black base.



PART #	MFG #	DESCRIPTION		
OP219	RE-52AK	Amber Reflector	2.50	G



RECTANGULAR REFLECTORS

Acrylic rectangular reflectors for surface mount. Self-adhesive and screw mount.



PART #	MFG #	DESCRIPTION		
OP221	RE-15AK	Amber Reflector	3.45	G
OP222	RE-15RK	Red Reflector	3.45	B

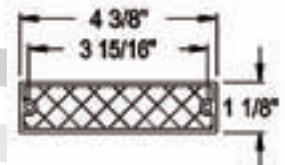

OBLONG REFLECTORS

Acrylic oblong reflectors for surface mount. Self-adhesive and screw mount.



PART #	MFG #	DESCRIPTION		
OP127	RE-12AK	Amber Reflector	3.25	G
OP128	RE-12RK	Red Reflector	3.25	G

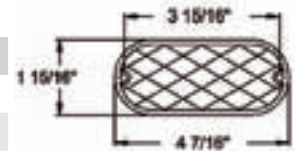

3-3/16" ROUND REFLECTORS

Round acrylic reflectors for surface mount. Self-adhesive.

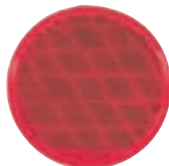
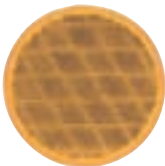

PART #	MFG #	DESCRIPTION		
OP217	RE-21AS	Amber Reflector	1.70	G
OP218	RE-21RS	Red Reflector	1.70	G



tires & wheels
axles, hubs & springs
tongue accessories
hitches
electrical
brake parts
trailer hardware
locks & pins
towing & loading
tie downs
tools
chemicals

TRAILER

UTILITY & LICENSE LIGHTS

LED LICENSE PLATE LIGHT WITH BRACKET



LED license plate light attached to corrosion proof bracket. Design includes both lead and ground wires for mounting to all surfaces. Features coated gray housing.

PART #			
OP2002	16.55	G	

LICENSE PLATE/UTILITY/DASH LIGHT



Snap-in license plate/utility/dash light, chrome plated. Mounts in 1-1/4" diameter hole. Replaceable bulb. Single wire design grounds through mounting hardware. Two units required for legal license illumination. Available in colorful retail packaging.

PART #			
OP11	3.65	G	

MINI LICENSE PLATE LIGHT



Mini license plate light features polished, chrome-plated housing. Mounting ears for surface mount. Mounts on 2" centers. Design includes both lead and ground wires for mounting to all surfaces. Gasket included for water resistance. Replaceable bulb (GE194). Available in colorful retail packaging.

PART #			
OP310	4.40	H	

LICENSE PLATE LIGHT WITH BRACKET



Unit includes a black powder-coated, steel license plate bracket riveted to light. Surface mounts on a 3-1/4" centers.

PART #			
PM4360	13.95	G	

CHROME, STUD MOUNT LICENSE PLATE LIGHT



Features patented Vibar® socket and single lens screw for easy bulb replacement (#GE168). Ideal as replacement light for foreign car license illuminators or for customizing trucks, vans, and trailers.

PART #			
PM436X	13.95	G	

LICENSE PLATE LIGHT



Features patented Vibar® socket and ABS hood. All internal parts are durable stainless-steel or tinned-brass. Bulb is replaceable (#GE168). Surface mounts on 3-1/4" centers.

PART #			
PM436	9.95	G	

CHROME LICENSE PLATE LIGHT



Features patented chrome-plated steel housing and mounting bracket. Traditional style, bulb replaceable light surface mounts on 2" centers and grounds through mounting screws.

PART #			
PM435	7.95	G	



LICENSE PLATE BRACKETS BLACK PLASTIC OR STEEL



BLACK ANGLED

PART #			
OP20	Display Pkg.	3.25	G
OP19	Bulk	0.80	J



PLASTIC STRAIGHT

PART #			
OP22	Bulk	0.80	N



STEEL ZINC PLATED

PART #			
PM4289	Bulk	4.95	G

tires & wheels

axles, hubs & springs

tongue accessories

hitches

electrical

brake parts

trailer hardware

locks & pins

towing & loading

tie downs

tools

chemicals

TRAILER

SPECIALTY LIGHTING

NIGHTWATCHER® LX CLEAR OE-STYLE FOG LIGHT



• Popular original equipment style clear driving light kit • Designed to mount in most factory and aftermarket air dams • Can be mounted on top or bottom of bumper • 55-watt halogen bulb • Black plastic housing • Replaceable, hardened-glass lens • Kit contains two lights, rocker switch, wiring, and installation instructions

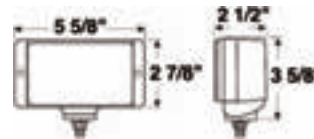

PART #	MFG #	DESCRIPTION	
PM5661	V566-1	Viz Pack	40.95 G

NIGHTWATCHER® LX ULTRA-SLIM CLEAR FOG LIGHT



• Low profile clear fog light provides wide, low beam for better vision of the road ahead and cuts through rain, mist and snow • 55-watt halogen bulb • Ion-coated lens • Black metal housing • Mounts above or below bumper • Kit contains two lights, rocker switch, wiring, and installation instructions

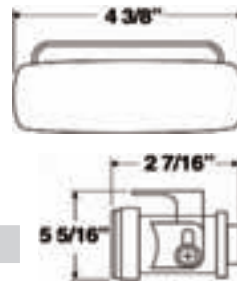

PART #	MFG #	DESCRIPTION	
PM5562	V5562-2	Viz Pack	54.95 G

UTILITY-DOCK FLOOD LIGHT



Includes two quality halogen 55W lights, rubber bracket boots, safety-fused wiring harness and lighted switch. Black ABS housing.

PART #	MFG #	DESCRIPTION	
OP16	DL-16CC	Clamshell Pack	36.55 G

6" ROUND OFF-ROAD LIGHT



• 6" light produces over 250, 000 candle power • Durable steel housing finished in black E-coat for long-lasting service • Aluminum-coated metal reflector • Hardened-glass lens • H3 100-watt halogen bulb • Armored cables • Universal swiveling, rubber cushioned mounting bracket • For off-road use only

PART #	MFG #	DESCRIPTION	
PM530	V530	Viz Pack	49.95 G

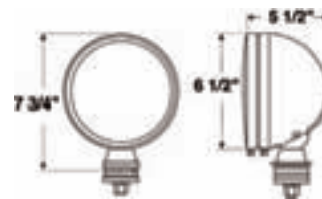

6" CHROME OFF-ROAD LIGHT

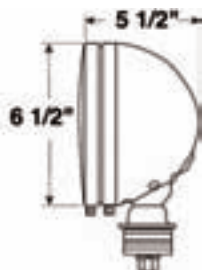

• 6" light produces over 250, 000 candle power • Durable chrome plated steel housing • Aluminum-coated metal reflector • Hardened-glass lens • H3 100-watt halogen bulb • Armored cables • Universal swiveling, rubber cushioned mounting bracket • For off-road use only

PART #	MFG #	DESCRIPTION	
PM531	V531	Viz Pack	48.95 G

tires & wheels
axles, hubs & springs
tongue accessories
hitches
electrical

brake parts
trailer hardware
locks & pins
towing & loading

tie downs
tools
chemicals

TRAILER

SPECIALTY LIGHTING



LED WORK LIGHTS



LED work lights perfect for exterior use in AG, horse, livestock, RV, industrial and racing applications. Environmentally sealed design with aluminum housing and stainless steel mounting stud. High power, true white 9-36V, 10W light emission. Rectangular version with 10 LED diodes, circular model has 6 LED diodes.

Circular: 4.5" dia. x 1.5" depth
Rectangular: 4" x 4" x 1.5" depth

PART #	MFG #	DESCRIPTION		
444301	54209-001	Circular LED Light, 6 Diodes	96.60	B
444302	54209-002	Rectangular LED Light, 10 Diodes	105.05	B
444303	54209-003	Rectangular LED Light, 10 Diodes w/ Molded 2-Way Plug	100.91	B



CIRCULAR LED WORK LIGHT WITH COILED CORD & MAGNETIC BASE



LED work lights perfect for exterior use in AG, horse, livestock, RV, industrial and racing applications. Environmentally sealed design with 19' extended coiled cord. Magnetic base, with protective film, secures in high vibration conditions in a vertical or horizontal position. Power adapter for 12V outlet with separate on/off switch. High power, true white 9-36V, 10W light emission. Circular version with 10 LED diodes, circular model has 6 LED diodes.

Circular: 4.5" dia. x 1.875" depth

PART #	MFG #	DESCRIPTION		
928582	54209-017	Circular LED Work Light w/Magnetic Base	112.95	B



RECTANGULAR LED WORK LIGHT WITH COILED CORD & MAGNETIC BASE



LED work lights perfect for exterior use in AG, horse, livestock, RV, industrial and racing applications. Environmentally sealed design with 19' extended coiled cord. Magnetic base, with protective film, secures in high vibration conditions in a vertical or horizontal position. Power adapter for 12V outlet with separate on/off switch. High power, true white 9-36V, 10W light emission. Rectangular version with 10 LED diodes, circular model has 6 LED diodes.

Rectangular: 4" x 4" x 1.75" depth

PART #	MFG #	DESCRIPTION		
928583	54209-018	Rectangular LED Work Light w/ Magnetic Base	121.24	B

- tires & wheels
- axles, hubs & springs
- tongue accessories
- hitches
- electrical**
- brake parts
- trailer hardware
- locks & pins
- towing & loading
- tie downs
- tools
- chemicals

TRAILER

SPECIALTY LIGHTING

- tires & wheels
- axles, hubs & springs
- tongue accessories
- hitches
- electrical
- brake parts
- trailer hardware
- locks & pins
- towing & loading
- tie downs
- tools
- chemicals

TRAILER



3" X 5" TRACTOR/WORK LIGHT



- Low profile, rectangular lamp with a flood beam pattern
- Black plastic housing
- Adjustable stainless steel mounting hardware
- Replaceable 55W H3 halogen bulb

PART #	MFG #	DESCRIPTION	
PM502	V502HF	Viz Pack	23.95 G

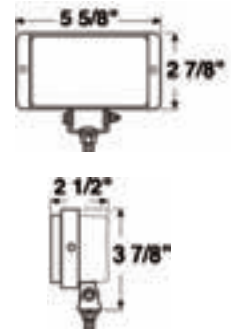

4" X 6" TRACTOR/WORK LIGHT



- 4" x 6" lens with a flood beam pattern
- Black polycarbonate housing with black-plated mounting bracket for corrosion-free service
- Replaceable 55W H3 halogen bulb

PART #	MFG #	DESCRIPTION	
PM5040	V504HF	Viz Pack	28.95 G

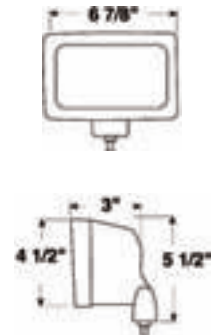

PAR 36 RUBBER TRACTOR LIGHT



- Rubber molded housing cushions lamp from shock and vibration
- Features flood beam pattern
- Universal 5/16" mounting stud and adjustable zinc-plated bracket allow mounting in any position
- Accepts standard or halogen replacement bulb

PART #	MFG #	DESCRIPTION	
PM507	V507	Viz Pack	24.95 G

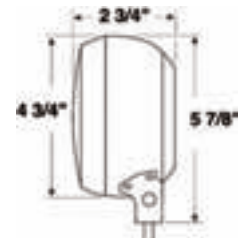

4" X 6" HALOGEN RUBBER TRACTOR LIGHT



- Heavy-duty, high-impact rubber housing is designed to survive in extreme environments such as construction and sanitation trucks
- Rubber hood reduces glare and provides added protection
- H9411 halogen sealed beam with trapezoidal pattern

PART #	MFG #	DESCRIPTION	
PM509	V509	Viz Pack	48.95 G

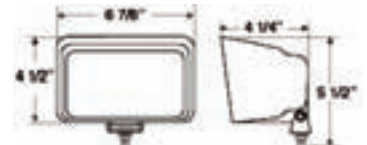

SPECIALTY LIGHTING



5" UTILITY/TRACTOR LIGHT

- With shock proof rubber housing and #GE4411 sealed beam bulb
- Adjustable zinc plate steel bracket
- Universal 5/16" mounting post

PART #	MFG #	DESCRIPTION	
OP10	TL-10SS	Clamshell Pack	21.20 G



4" X 6" AUXILIARY WORK LIGHT

- Magnetic-mount auxiliary work light • Flood beam pattern • Replaceable 55W H3 halogen bulb • Black ABS housing • 15' cord with 12V lighter style plug • Self service Viz Pack packaging

PART #	MFG #	DESCRIPTION	
PM504	V504HFM	Viz Pack	52.95 G

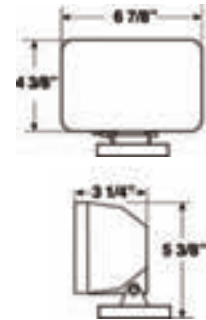

UTILITY/INTERIOR LIGHTS



INTERIOR LIGHT

- Polycarbonate 12-volt interior dome light with nylon switch • For bright general illumination • Metal base surface mounts with screws on 3-1/2" centers • Separate ground and lead wires supplied for electrical connection

PART #	MFG #	DESCRIPTION	
PM391	V391C	Viz Pack	9.95 G

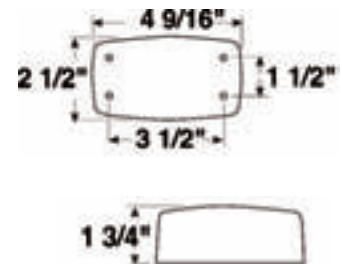

DOMELIGHT

- Durable 12-volt interior dome light with switch • For bright general illumination • Plastic translucent lens snaps securely onto base • Plastic base for corrosion-free service • Surface mounts and grounds through base • Single lead wire supplied for electrical connection

PART #	MFG #	DESCRIPTION	
PM390	V390S	Viz Pack	13.95 G

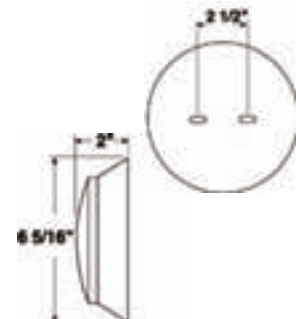

- tires & wheels
- axles, hubs & springs
- tongue accessories
- hitches
- electrical**
- brake parts
- trailer hardware
- locks & pins
- towing & loading
- tie downs
- tools
- chemicals

TRAILER

UTILITY/INTERIOR LIGHTS



RECTANGULAR PORCH/UTILITY LIGHTS



- Surface mount porch or utility light available with switch • Snap-in lens allows for easy bulb replacement (#93) • Contains separate ground wire • Polar white

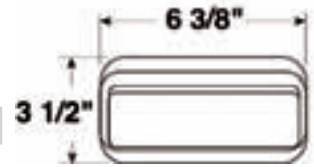

PART #	MFG #	DESCRIPTION		
PM384	V384S	Viz Pack	19.95	G



12 VOLT UTILITY LIGHTS - TWO STYLES



PART # BY2100
1 Incandescent Bulb
35 Watts



PART # BY2110
54 Diodes • Clear
(Very Low Amp Draw)

- Rugged, all-purpose utility light (ideal for salt spreader applications) • 5" sealed rubber housing w/polycarbonate lens • Includes 5/16" stainless steel stud & universal adjustable mounting bracket • Shock resistant & waterproof • 4.92"W x 3.15"D x 7"H • Display packaged

PART #	MFG #	DESCRIPTION		
BY2100	1492100	Incandescent Bulb	11.95	H
BY2110	1492110	54 Diodes, Clear	43.95	G

REPLACEMENT BULBS

Priced each
but sold only in
packages of 10.

PART #	DESCRIPTION	U/M	PART #	DESCRIPTION	U/M
GE168	(#168)	0.60 EA L	GE97	(#67 same)	0.50 EA L
GE1895	(#57 same)	0.50 EA L	GE1156	Single Filament	0.50 EA L
GE1034	(#1157 same)	0.50 EA L	GE1034	Double Filament	0.50 EA L
GE194	Push-In Type	0.50 EA L			



tires & wheels
axles, hubs & springs
tongue accessories
hitches
electrical
brake parts
trailer hardware
locks & pins
towing & loading
tie downs
tools
chemicals

STROBE LAMPS & TOWING LIGHT KITS



2 JOULE SINGLE FLASH STROBE BEACON
60 FLASHES PER MINUTE



• 12 volt • Single flash with fresnel lens • 2 joule / 150 candela per second brightness • Shock-resistant rubber base, encapsulated circuitry • Magnetic-mount model is equipped with 15' coil cord and lighter socket plug with built-in on/off switch and LED indicator

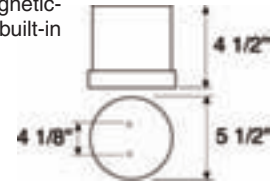

PART #	MFG #	DESCRIPTION		
PM769	769A	Boxed	105.95	B



MICRO-STROBE LIGHT 78 FLASHES PER MINUTE



A compact, low-profile flashing strobe light. Unit features a polycarbonate lens and a bright two-joule (2.6 watt/sec) flash. A threaded screw -on lens with O-ring seal offers water resistant performance. Complete with magnetic base and a 12 foot coiled cord that plugs into the cigarette lighter.



PART #	MFG #	DESCRIPTION		
PM766	V766MA	Viz Pack	97.95	G



ALTERNATING FLASHING BEACON
STROBE LIKE FLASHING



Unique design features two bulbs for maximum performance. Alternating strobe light action produces bursts of light for increased visibility. 3 powerful magnets and a 12 foot coiled cord with cigarette lighter plug. 12 volt only. Sold each.

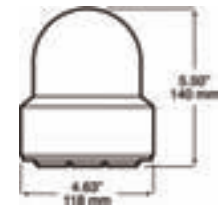

PART #	MFG #	DESCRIPTION		
PM7731	V773A	Viz Pack	97.95	G

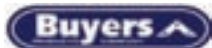

HIGH VISIBILITY STROBE LIGHTS



Buyers Strobe Lights feature a replaceable "U" shaped flash tube rated at 1.7 joules, and multi-olt operation (12-110V). Choose from permanent-mount or magnetic-mount. Magnetic-mount comes with self-coiled cord and cigarette plug adapter. Approx. dimensions: 6" dia. x 4-3/4" h.



PART #	MFG #	DESCRIPTION		
BY650A	SL650A	Boxed	67.95	G

- tires & wheels
- axles, hubs & springs
- tongue accessories
- hitches
- electrical
- brake parts
- trailer hardware
- locks & pins
- towing & loading
- tie downs
- tools
- chemicals

TRAILER

STROBE LAMPS & TOWING LIGHT KITS

- tires & wheels
- axles, hubs & springs
- tongue accessories
- hitches
- electrical
- brake parts
- trailer hardware
- locks & pins
- towing & loading
- tie downs
- tools
- chemicals

TRAILER

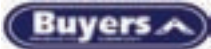

MAGNETIC MOUNT REVOLVING SAFETY LIGHT



The 12-volt teardrop light is ideal for use on vehicles where a permanent-mount light is not possible. The magnetic base secures the light while in operation, and allows you to remove the light when not in use. This revolving light comes with a 10' coiled power cord, cigarette plug adapter and a backup replacement bulb.

Approx. dimensions: 7" base dia. x 5 1/4" h.



PART #	MFG #	DESCRIPTION		
BY650	RL650A	Boxed	25.95	G



HEAVY DUTY TOWING LIGHT SET



This light set offers quick and easy installation/removal with a sturdy magnetic base. A durable 30' cord with 4-pole spring plug easily activates turn signal, brakes and tail lights. Visible for up to one mile. Includes plastic storage case.



PART #	MFG #	DESCRIPTION		
BY257	TL257M	Boxed	82.95	G



TOWING LIGHT KIT



Strong magnetic base allows placement of lights on any auxiliary towing application. 20' four wire harness plugs into standard flat 4 wire connector. Kit includes 2 lights, wire harness and instructions.



PART #	MFG #	DESCRIPTION		
PM555	V555	Boxed	55.95	G



7-WAY RV BLADE CONNECTORS - WESBARGG

METAL

- The standard of the industry
- 12 volt metal connector with plastic core
- Zinc plated to protect against corrosion
- Trigger grip for easy disconnect



BAGGED

PART #	MFG #	DESCRIPTION		
BG515705	54-57-503	Car end w/mounting bracket	9.91	G
BG515707	54-57-007	Trailer end	7.87	G

BULK

PART #	MFG #	DESCRIPTION		
BG505705	50-57-503	Car end	9.40	G
BG505707	50-57-007	Trailer end	7.09	G

PLASTIC

- 12 volt thermo-plastic connector with brass contacts to prevent corrosion
- Built-in cable clamp prevents wear on 7-way cable
- All die cast metal



BAGGED

PART #	MFG #	DESCRIPTION		
BG517705	54-77-001	Car end w/mounting bracket	7.45	G
BG517703	54-77-003	Trailer end	6.49	G

BULK

PART #	MFG #	DESCRIPTION		
BG507705	50-77-001	Car end	7.02	G
BG507703	50-77-003	Trailer end	6.05	G



6-WAY ZINC DIE CAST CONNECTOR

- Round brass split pins to insure a good contact
- Floating make pins promote easy connect and disconnect
- Interchangeable with all popular 6-way connectors



BAGGED

PART #	MFG #	DESCRIPTION		
BG516001	54-60-001	Car end	10.35	G
BG516003	54-60-003	Trailer end	8.75	G

BULK

PART #	MFG #	DESCRIPTION		
BG506001	50-60-001	Car end	9.40	G
BG506003	50-60-003	Trailer end	6.80	G



6-WAY AND 7-WAY PLUG HOLDER

This holder is designed to house your 6-way or 7-way trailer end connector safely out-of-the-way when disconnected from the tow car. Universal holder will accommodate either die cast, steel, plastic or molded trailer ends. Black molded plastic holder mounts on the jackpost with provided cable-ties or the attached adhesive strip and can be mounted on any flat surface with provided screws.



BAGGED

PART #	MFG #	DESCRIPTION		
444317	54-98-003	6-Way and 7-Way Plug Holder	6.52	B



6-WAY AND 7-WAY CONNECTOR HOLDER

- Securely stores 6 and 7-Way Trailer Connectors when not in use
- Mount to tongue jack or trailer frame

BAGGED

PART #	MFG #	DESCRIPTION		
444318	118152	6-Way and 7-Way Trailer Connector Holder	7.87	B



TRAILER CONNECTOR HOLDER

- Universal holder stores trailer end connector safely when disconnected from tow vehicle
- Holds both 1" and 1-1/2" diameter connector ends
- Mounts on trailer jack post with included cable ties, or any flat surface with included screws

PART #	MFG #	DESCRIPTION		
PM5419	50-77-070	Viz Pack	7.95	G



tires & wheels

axles, hubs & springs

tongue accessories

hitches

electrical

brake parts

trailer hardware

locks & pins

towing & loading

tie downs

tools

chemicals

TRAILER

- tires & wheels
- axles, hubs & springs
- tongue accessories
- hitches
- electrical
- brake parts
- trailer hardware
- locks & pins
- towing & loading
- tie downs
- tools
- chemicals

WesBarg CAR END MOUNTING BRACKETS

Heavy duty plated steel brackets. Features reinforcing beads or flanges for strength. The Black plated model can blend in with the black connector and black hitch for clean consistent finish. Combination brackets have a black, powder coat finish and are formed from 16 gauge steel for strength and durability. Combination brackets are for use with Wesbarg and Wesbarg branded 4-Way and 5-Way Flat connectors.

4-WAY FLAT CAR END CONNECTOR MOUNTING BRACKETS

PART #	MFG #	DESCRIPTION			
444319	54-18137	4, 5 and 6-Way Round Black Mounting Bracket w/ Screws and Nuts	(A)	8.92	B

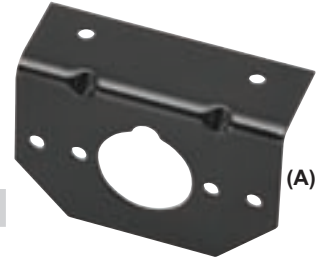

5-WAY FLAT CAR END CONNECTOR MOUNTING BRACKETS

PART #	MFG #	DESCRIPTION			
444320	54-20045	5-Way Flat Black Mounting Bracket	(B)	3.88	B
444319	54-18137	4, 5 and 6-Way Round Black Mounting Bracket w/ Screws and Nuts	(A)	8.92	B

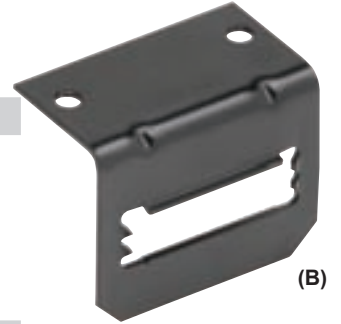

6-WAY FLAT CAR END CONNECTOR MOUNTING BRACKETS

PART #	MFG #	DESCRIPTION			
444319	54-18137	4, 5 and 6-Way Round Black Mounting Bracket w/ Screws and Nuts	(A)	8.92	B

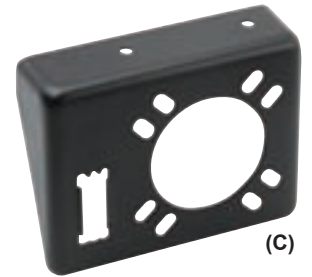

COMBINATION CONNECTOR MOUNTING BRACKETS

PART #	MFG #	DESCRIPTION			
444322	54-77-074	7_Way and 4-Way Flat Mounting Bracket	(C)	9.58	B
444323	54-77-075	7_Way and 5-Way Flat Mounting Bracket	(C)	10.00	B

WesBarg 7-WAY CAR END CONNECTOR MOUNTING BRACKET

- Zinc plated heavy-duty 16 gauge steel with reinforced beads and flanges for strength
- Sold each (bulk)
- To be used with either 7 way connector sold on previous page

PART #	MFG #	COLOR		
BG507770	50-77-070	Zinc	1.64	G
BG507771	50-77-071	Black	1.66	G

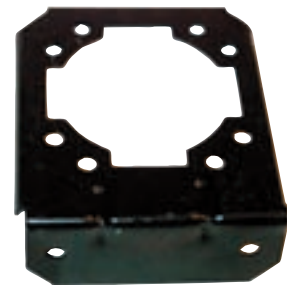

4-WAY AND 6-WAY MOUNTING BRACKET

PART #	MFG #	DESCRIPTION		
444324	118132	Mounting Bracket for 4 & 6-Way Round Connectors (Does not include Fasteners)	7.61	B

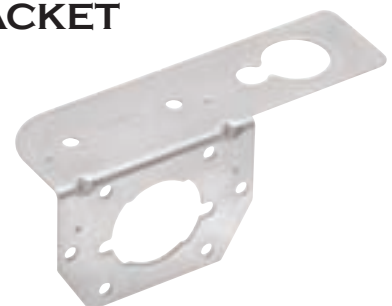

ELECTRICAL MOUNTING BRACKET 4 • 5 • 6 • 7 WAY CONNECTORS

- These mounting brackets allow for installation of electrical wiring plugs on vehicles without damage to bumpers or trim
- Attachment brackets are designed to attach above or below receiver cross tube with hose clamp

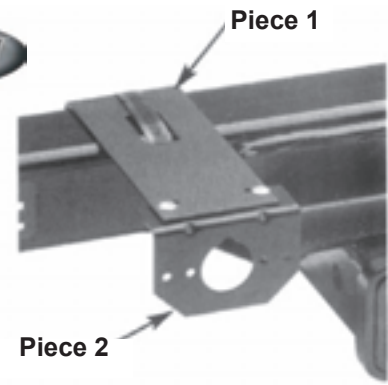

ATTACHMENT BRACKET (PIECE 1 OF 2)

- Attaches to cross tube of hitch

PART #	MFG #	DESCRIPTION		
444325	118136	Attachment Bracket For 6 & 7-Way Round Connectors, Includes Clamp (Piece 1 Of 2, Long Bracket)	13.18	B
444326	118140	Attachment Bracket For 4-Flat, 5-Flat, 4-Way & 5-Way Round Connectors, Includes Clamp (Piece 1 Of 2, Short Bracket)	12.69	B



MOUNTING BRACKETS (PIECE 2 OF 2)

- Mounts electrical connector to attachment bracket
- Includes screws and nuts
- Attractive point-of-purchase packaging

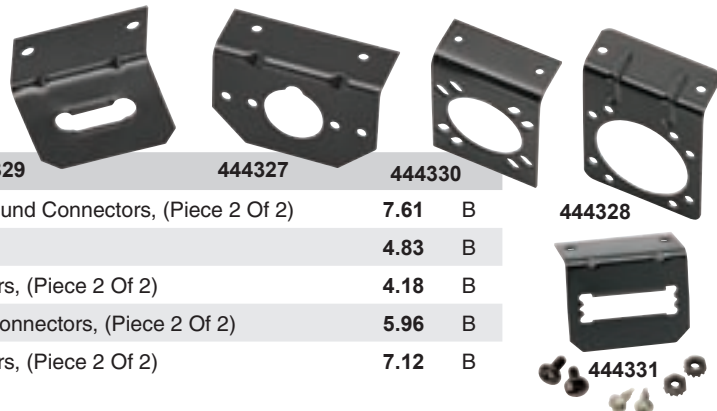

PART #	MFG #	DESCRIPTION	444329	444327	444330	
444327	118137	Mounting Bracket For 4, 5 & 6-Way Round Connectors, (Piece 2 Of 2)				7.61 B
444328	118138	Mounting Bracket, (Piece 2 Of 2)				4.83 B
444329	118144	Mounting Bracket For 4-Flat Connectors, (Piece 2 Of 2)				4.18 B
444330	20212	Mounting Bracket For 7-Way Us Car Connectors, (Piece 2 Of 2)				5.96 B
444331	20046	Mounting Bracket For 5-Flat Connectors, (Piece 2 Of 2)				7.12 B

4-WAY FLAT CAR END CONNECTOR MOUNTING BRACKETS

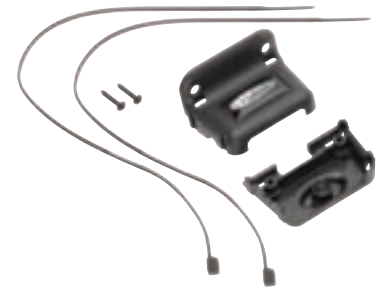

PART #	MFG #	DESCRIPTION		
444332	118149	4-Way Flat Universal Mounting Bracket	6.49	B

6-WAY AND 7-WAY CONNECTOR MOUNTING BOXES

- No need to disconnect existing wiring
- No drilling
- Mounts with hose clamp included
- Corrosion free
- High impact plastic
- Fits all standard & U.S. car 7-way connectors



PART #	MFG #	DESCRIPTION		
444314	118156	6-Way and 7-Way Connector Mounting Box For Hitches w/2-1/2" Sq. Cross Tubes	10.66	B
444315	118157	6-Way and 7-Way Connector Mounting Box For Hitches w/3" Sq. Cross Tubes	10.66	B
444316	118159	6-Way and 7-Way Connector Mounting Box With Universal Fit For Both Square And Round Tube Hitches	12.59	B

- tires & wheels
- axles, hubs & springs
- tongue accessories
- hitches
- electrical
- brake parts
- trailer hardware
- locks & pins
- towing & loading
- tie downs
- tools
- chemicals

TRAILER

VEHICLE / TRAILER ADAPTERS



- tires & wheels
- axles, hubs & springs
- tongue accessories
- hitches
- electrical
- brake parts
- trailer hardware
- locks & pins
- towing & loading
- tie downs
- tools
- chemicals

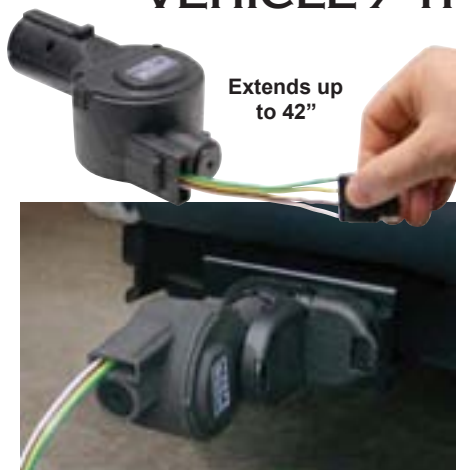

7-WAY TO 4-WAY RETRACTABLE WIRING ADAPTER

- Converts 7-way round blade connector to standard 4-way flat connector
- Adjust length up to 42", no wires dragging on the ground
- Retractable 4-way flat car end plug connects with standard 4-way flat trailer end plug
- Adapts to factory 7-way blade receptacle
- Protects & stores when not in use

PART #	MFG #	DESCRIPTION		
444333	78007	7-way Round Blade to 4-way Flat	59.44	B



7-WAY BLADE TO 4-FLAT W/LED CIRCUIT TESTER

- Easily adapt OEM 7-way blade connector to either 5-flat or a 4-flat connector, Patent pending
- Instantly checks electrical circuit for connectivity
- Displays connectivity using high visibility Blue LEDs
- Attached dust cover included to keep terminals clean when not towing a trailer

PART #	MFG #	DESCRIPTION		
444334	78118	7-Way Blade to 4 or 5-Flat w/LED Circuit Tester	20.85	B



7-WAY TO 4-WAY WITH TOW-GLO

- Easily adapt OEM 7-way blade connector to basic 4-flat connector
- Glows BLUE when tail light circuit is activated assisting on seeing connection at night-time
- Attached dust cover included to keep terminals clean when not towing a trailer

PART #	MFG #	DESCRIPTION		
444335	78117	7-Way Blade to 4-Flat w/Tow-Glo	18.84	B



7-WAY TRAILER EXTENSION



- Durable connectors
- 7 ft. lead reaches almost anywhere

PART #	MFG #	DESCRIPTION		
444337	118664	7-Way Connector - extension cable 7'	53.19	B



5-WAY FLAT WIRE HARNESES

Color coded harnesses in various lengths available with car and trailer end connectors. Trailer ends can be purchased in wunside or wishbone harness styles. Various length and combinations are available.

444338

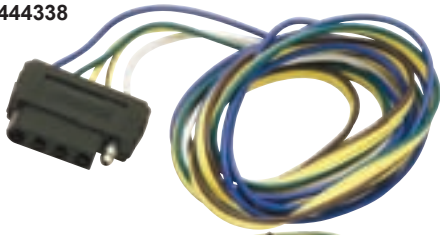

5-WAY FLAT CAR END WIRE HARNESS

PART #	MFG #	DESCRIPTION		
444338	702305	5-Way Flat 4 Ft. Car End , 18" Ground, 4 Ft. Auxiliary	8.65	B

444339



5-WAY FLAT TRAILER END WIRE HARNESS - WISHBONE STYLE

PART #	MFG #	DESCRIPTION		
444339	702275	5-Way Flat 25 Ft. Trailer End, Wishbone Harness, 4 Ft. Ground, 5 Ft. Auxiliary	19.81	B

444340



5-WAY FLAT TRAILER END WIRE HARNESS WITH CAR END - WISHBONE STYLE

PART #	MFG #	DESCRIPTION		
444340	707105	5-Way Flat 25 Ft. Trailer End, Wishbone Harness Kit w/Hardware, 4 Ft. Ground, 5 Ft. Auxiliary w/6 Ft. Car End, 6 Ft. Ground, 6 Ft. Auxiliary	33.41	B

444341



DOUBLE ENDED 5-WAY FLAT WIRE HARNESS - EXTENSION STYLE

PART #	MFG #	DESCRIPTION		
444341	707255	Double Ended 5-Way 2 Ft. Cord (5-Way Flat Car and Trailers Ends	9.05	B

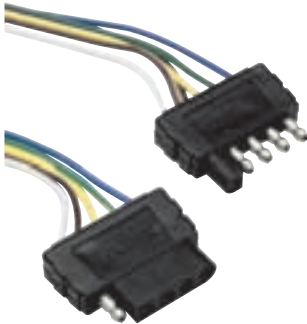

5-WAY FLAT ELECTRICAL WIRE HARNESES



- Fifth wire added for surge brake lockout or backup light circuit on today's newer trailers
- 7.5 amps maximum per circuit

PART #	MFG #	DESCRIPTION		
444342	118016	5-Flat 72" Car End Wiring Harness	9.28	B
444343	118017	5-Flat 48" Trailer End Wiring Harness	8.64	B
444344	118215	5-Flat 72" Car & Trailer End Loop	10.97	B

444345



4-WAY FLAT DUST COVER



PART #	MFG #	DESCRIPTION		
444345	787301	4-Way Flat Dust Cover	4.74	B

444346



4-WAY FLAT DUST COVER W/LED TESTER



PART #	MFG #	DESCRIPTION		
444346	118147-025	4-Way Flat Dust Cover w/LED Tester	65.24	B

444347



5-WAY FLAT DUST COVER



PART #	MFG #	DESCRIPTION		
444347	20118	Dust Cover, 5-Flat Connector	2.56	B

tires & wheels

axles, hubs & springs

tongue accessories

hitches

electrical

brake parts

trailer hardware

locks & pins

towing & loading

tie downs

tools

chemicals

TRAILER



- tires & wheels
- axles, hubs & springs
- tongue accessories
- hitches
- electrical
- brake parts
- trailer hardware
- locks & pins
- towing & loading
- tie downs
- tools
- chemicals

444351



927285



444352



947103



444353



444348



444349



4-WAY FLAT WIRE HARNESSES

Color coded harnesses in various lengths available with car and trailer end connectors. Trailer ends can be purchased in straight lengths, loops, wunside or wishbone harness styles. Various length and combinations are available.

4-WAY FLAT CAR END WIRE HARNESS

PART #	MFG #	DESCRIPTION		
444351	707272	4-Way Flat 6 Ft. Car End, 6 Ft. Ground	8.76	B

4-WAY FLAT TRAILER END WIRE HARNESS - WUNSIDE STYLE

PART #	MFG #	DESCRIPTION		
927285	707285	4-Way Flat 18" Trailer End, Wunside Harness, 18" Ground	3.50	AD

4-WAY FLAT TRAILER END WIRE HARNESS - WISHBONE STYLE

PART #	MFG #	DESCRIPTION		
444352	707286	4-Way Flat 18" Trailer End, Wishbone Harness, 18" Ground	5.67	B

4-WAY FLAT TRAILER END WIRE HARNESSES WITH CAR ENDS - WISHBONE STYLE

PART #	MFG #	DESCRIPTION		
927270	707270	4-Way Flat 18" Trailer End, Wishbone Harness, 18" Ground w/4 Ft. Car End, 18" Ground	8.30	G
927103	707103	4-Way Flat 25 Ft. Trailer End, Wishbone Harness Kit w/Hardware, 3 Ft. Ground w/4 Ft. Car End, 18" Ground	26.95	G

DOUBLE ENDED 4-WAY FLAT WIRE HARNESS - EXTENSION STYLE

PART #	MFG #	DESCRIPTION		
444353	707254	Double Ended 4-Way 2 Ft. Cord (4-Way Flat Car & Trailer Ends)	7.45	B

4-WAY FLAT WIRE HARNESSES WITH COILED CABLE

Coiled 14 gauge cable available with 4-way flat trailer end connectors. Cable extended length to 11 feet.

PART #	MFG #	DESCRIPTION		
444348	54000-026	7-Way Connector - extension cable 7'	25.85	B

4-WAY FLAT CONNECTORS WITH JACKETED CABLE

Color coded sealed cable available with trailer end connector, jacketed cable and 4' stripped wire leads. No exposed wires and sealed for environmental protection.

PART #	MFG #	DESCRIPTION		
444349	787264	4-Way Flat 4' Trailer End w/Jacketed Cable	11.12	B
444350	787268	4-Way Flat 8' Trailer End w/Jacketed Cable	16.72	B

MULTI-TOW® ADAPTERS



Hopkins® Multi-Tow® adapters provide multiple towing options from one vehicle-end connector creating a true customized Plug-In Simple!® wiring system.

ENDURANCE™ MULTI-TOW® 7 TO 6, 5 AND 4

- Patented Quick-Change™ plug quickly accommodates both 6 pole wiring codes
- Provides four towing options from a single device
- Overbuilt hinge, lid and connector housings provide maximum durability



PART #	MFG #		
647570	47570	25.55	G

MULTI-TOW® 6 : 4

- 4-wire flat to both 4-wire flat and 6 pole round adapter



PART #	MFG #		
647175	47175	37.05	G

MULTI-TOW® 7 TO 6 AND 4

- 7 RV blade to both 6 pole round and 4-wire flat
- Center pin auxiliary
- Center pin can be switched to auxiliary or electric brake



PART #	MFG #		
647565	47565	21.05	G

MULTI-TOW® 7 TO 6 AND 4 WITH NITE-GLOW™

- 7 RV blade to both 6 pole round and 4-wire flat
- Lights-up on taillight function



PART #	MFG #		
647585	47585	24.35	G

MULTI-TOW® 7 : 4

- 4-wire flat to both 4-wire flat and 7 RV blade adapter



PART #	MFG #		
647185	47185	37.05	G

MULTI-TOW® 7 TO 6 AND 4

- 7 RV blade to both 6 pole round and 4-wire flat
- Center pin electric brake
- Center pin can be switched to auxiliary or electric brake



PART #	MFG #		
647575	47575	21.05	G

MULTI-TOW® 7 TO 5 AND 4 WITH 12-VOLT

- 7 RV blade to 5-wire flat and 4-wire flat with 12-volt power socket



PART #	MFG #		
647675	47675	21.05	G

MULTI-TOW® 7 TO 5 AND 4

- 7 RV blade to both 5-wire flat and 4-wire flat
- Includes dust covers



PART #	MFG #		
647385	47385	21.05	G

L.E.D. ADAPTERS

FUNCTIONS TESTED	647325 6 TO 4	647345 7 TO 4	647525 7 TO 6	647535 7 TO 6
Right turn & brake	•	•	•	•
Left turn & brake	•	•	•	•
Taillights	•	•	•	•
Electric brake			•	•
Auxiliary				▲

▲ Can be rewired to test this function

7 RV BLADE TO 6 POLE ROUND

- Center pin auxiliary
- Built-in trouble-shooting
- Function testing L.E.D.s
- Universal - center pin can be switched to auxiliary or electric brake



PART #	MFG #		
647525	47535	18.65	G

6 POLE ROUND TO 4-WIRE FLAT

- Includes function testing L.E.D.s
- Includes dust cover



PART #	MFG #		
647325	47325	10.55	G

7 RV BLADE TO 6 POLE ROUND

- Center pin electric brake
- Built-in trouble-shooting
- Function testing L.E.D.s
- Universal - center pin can be switched to auxiliary or electric brake



PART #	MFG #		
647535	47535	18.65	G

7 RV BLADE TO 4-WIRE FLAT

- Includes function testing L.E.D.s
- Includes dust cover



PART #	MFG #		
647345	47345	10.55	G

7 RV BLADE TO 4-WIRE FLAT NITE-GLOW™

- Lights-up on taillight function
- Find your connection in the dark
- Includes dust cover



PART #	MFG #		
647335	47335	12.55	G

ENDURANCE™ QUICK-FIX™ 4-WIRE FLAT

- L.E.D. test lights confirm electrical continuity
- Ergonomic grip for easier handling
- Dust cover prevents corrosion to 4 wire flat
- Splicing inside the plug protects connections from the elements



PART #	MFG #		
655126	48193	TBA	

ENDURANCE™ QUICK-FIX™ 4-WIRE FLAT

- Replaces damaged 4-Wire Flat
- No external splices for enhanced weatherproofing
- Includes vehicle and trailer sides
- Corrosion resistant terminals



PART #	MFG #		
648195	48195	7.00	G

tires & wheels
axles, hubs & springs
tongue accessories
hitches
electrical
brake parts
trailer hardware
locks & pins
towing & loading
tie downs
tools
chemicals

TRAILER

POWER MANAGEMENT



Our power management products help you get 12-volt power wherever you may need it in your vehicle. Great for tailgating, camping, hunting, boating, emergency use...and countless other applications.

Products that plug into a 12-volt socket include blenders, coolers, air compressors, spot lights, radios, TVs...imagine the possibilities!



12-VOLT POWER SOCKET

- Flush-mount design means no drilling required
- Mounts anywhere 12-volt power is needed
- Weatherproof dust cover

PART #	MFG #		
655110	55110	18.30	G



7 RV BLADE TO 5-WIRE FLAT AND 4-WIRE FLAT WITH 12-VOLT

- Turn your 7 RV blade into a 12-volt power socket
- Weatherproof dust covers

PART #	MFG #		
647675	47675	21.05	G



12-VOLT POWER SOCKET WITH UTILITY LIGHT

- Provides L.E.D. utility light for multipurpose use
- Flush mount design
- Mounts anywhere 12-volt power is needed
- Weatherproof dust cover

BUILT-IN L.E.D. UTILITY LIGHT

PART #	MFG #		
655120	55120	16.50	G



12-VOLT POWER SOCKET

- Includes 17 ft. power wire and fuse assembly

PART #	MFG #		
655115	55115	18.30	G



12-VOLT POWER SOCKET WITH UTILITY LIGHT

- Includes 17 ft. power wire and fuse assembly

PART #	MFG #		
655125	55125	22.95	G



7 RV BLADES

Seven-pole connectors are typically used with large trailers (RV and industrial). These connectors provide all the functions of the 6 pole with the addition of the backup/reverse function.

7 RV BLADE CONNECTOR KIT

Contains matched set plastic plug and socket, mounting bracket and mounting hardware.



MOUNTING BRACKET ONLY
PART # 648615

Works with various 7-way RV and 7-way pole style vehicle end sockets

PART #		
648465	17.90	G

TRAILER END PLUG

(Plastic)



PART #		
648505	8.95	G

TOW VEHICLE END SOCKET

(Plastic)



PART #		
648485	9.30	G

TRAILER END PLUG

(Metal)



PART #		
648515	9.85	G

ENDURANCE™ TRAILER END PLUG



PART #		
648500	14.45	G

ENDURANCE™ TOW VEHICLE END SOCKET



PART #		
648480	15.20	G

ENDURANCE™ MULTI-TOW® 3-IN-1 CONNECTOR

7-5-4 vehicle end socket



PART #		
648470	29.65	G

TOW VEHICLE END SOCKET

(Metal)



PART #		
648495	11.35	G

7 RV BLADES

ENDURANCE™ FORD/CHEVY/ GMC OEM REPLACEMENT

- Compatible with Ford, GM and other popular tow vehicles
- Plug-In Simple!® for quick and easy installation or replacement
- Durable lid opens 180 degrees
- Ultimate weatherproofing



PART # MFG #
620415 40940 14.95 G

MAKE/MODEL	YEAR
AUDI	
Q3	09-15
Q5	09-14
Q7	07-15
BUICK	
Enclave	08-15
Rainier	02-15
CADILLAC	
Escalade / EXT / ESV	02-13
SRX	10-14

MAKE/MODEL	YEAR
CHEVY	
1500 Pickups	03-13
2500/2500 Pickups	99-13
1500/2500/3500	14-15
Avalanche	08-12
Tahoe	00-15
Trailblazer	02-09
Suburban	00-15
Colorado	03-15
Express Van	03-15
Traverse	10-15
CHRYSLER	
Aspen	07-09

MAKE/MODEL	YEAR
DODGE	
Durango	07-15
Nitro	07-09
Journey	09-10
Ram 1500 Pickups	10-15
Ram 2500/3500	10-15
FORD	
F-Series	08-15
Escape	13-15
Expedition	99-14
Excursion	00-05
Explorer	02-15
Explorer Sport Trac	07-10
Flex	09-15
E-Vans	04-14
GMC	
1500 Pickups	03-13
2500/3500 Pickups	99-13
1500/2500/3500	14-15
Envoy	02-09
Yukon/XL	00-15
Denali	00-15
Acadia	07-15
Canyon	08-12
Savanna Van	09-15

MAKE/MODEL	YEAR
HUMMER	
H2/H2 SUT	03-09
H3	06-09
H3 SUT	2009
INFINITY	
QX-56	04-15
ISUZU	
Ascender	04-08
JEEP	
Cherokee	14-15
Liberty	08-10
Gd. Cherokee	11-15
KIA	
Borrego	2009
LINCOLN	
Aviator	03-06
Navigator	99-15
Mark LT	06-08
MKT	09-14
MERCURY	
Mountaineer	02-10



MAKE/MODEL	YEAR
NISSAN	
Armada	04-13
Pathfinder	13-15
Titan	04-15
OLDSMOBILE	
Bravada	02-04
SAAB	
9-7X	05-10
SATURN	
Outlook	07-09
Transit	15
TOYOTA	
4-Runner	10-13
Sequoia	10-14
Tundra	14-15
VOLKSWAGON	
Toureg	12-15

ENDURANCE™ DODGE/CHRYSLER/JEEP OEM QUICK-INSTALL™ WIRING KIT

- Allows for Dodge trucks to adapt to the Quick-Install™ 7 RV Blade
- Reinforced lid opens 180 degrees to prevent breaking
- Ultimate weatherproofing



MAKE/MODEL	YEAR
CHRYSLER	
Aspen	Early 07
Pacifica	03-08
DODGE	
Ram 1500	00-09
Ram 2500/3500	00-09
Dakota	00-10
Durango	00-07
Sprinter	04-09
Ram Van	01-03

PART # MFG #
620416 42190 33.95 G

MAKE/MODEL	YEAR
JEEP	
Commander	06-10
Grand Cherokee	00-10
Liberty	05-07
Wrangler	04-15
MITSUBISHI	
GL-Class	07-10

ENDURANCE™ 4 FLAT TO 7 RV BLADE QUICK-INSTALL™ WIRING KIT



- Allows existing 4 flat to adapt to the Quick-Install™ 7 RV Blade
- Quick and easy installation or replacement
- Reinforced lid opens 180 degrees to prevent breaking
- Ultimate weatherproofing

PART # MFG #
620417 47200 33.95 G

ENDURANCE™ CHEVY/GM TWIST MOUNT BLADE

OEM Replacement



PART # MFG #
620412 40930 14.95 G

MODEL	YEAR
BUICK	
ENCLAVE	08-12
ASCENDER	04-08
CADILLAC	
ESCALADE/ EXT	02-13

MODEL	YEAR
CHEVY	
1500 PICKUPS	03-13
2500/3500 PICKUPS	99-13
AVALANCE	02-13
TAHOE	00-13
TRAILBLAZER	02-09
SUBURBAN	00-15
COLORADO	08-11
EXPRESS VAN	03-13
SAVANA VAN	09-13

GMC	
ENVOY	02-09
YUKON/XL/DENALI	01-14
ACADIA	07-12
CANYON	08-13

HUMMER	
H2/ H2 SUT	03-09
H3	06-09
H3T	2009
RAINIER	04-07

OLDSMOBILE	
BRAVADA	02-04

SAAB	
9-7X	05-10

SATURN	
OUTLOOK	07-09
TRAVERSE	10-13

ENDURANCE™ 7 BLADE MOLDED CABLE



- 3 foot cable
- Mounts to vehicle bumper

PART # MFG #
620419 20022 46.95 G

ENDURANCE™ UNIVERSAL QUICK-INSTALL™ WIRING KIT

- Pre-wired universal connection allows for flexibility in installation
- Plug-In Simple!® for quick and easy installation
- Reinforced lid opens 180 degrees to prevent breaking
- Ultimate weatherproofing



PART # MFG #
620418 47210 29.95 G

tires & wheels

axles, hubs & springs

tongue accessories

hitches

electrical

brake parts

trailer hardware

locks & pins

towing & loading

tie downs

tools

chemicals

TRAILER

PLUG-IN SIMPLE!® ADAPTERS



- tires & wheels
- axles, hubs & springs
- tongue accessories
- hitches
- electrical
- brake parts
- trailer hardware
- locks & pins
- towing & loading
- tie downs
- tools
- chemicals

4-WIRE FLAT TO 6 POLE ROUND

(Plastic)



PART #
647155 31.10 G

4-WIRE FLAT TO 6 POLE ROUND

(Metal)



PART #
647165 31.10 G

4-WIRE FLAT TO 7 RV BLADE

(Plastic)



PART #
647205 33.00 G

6 POLE ROUND TO 4-WIRE FLAT

(With dust cover)



PART #
647305 9.15 G

6 POLE ROUND TO 4-WIRE FLAT

(Flexible, with dust cover)



PART #
647315 15.60 G

7 RV BLADE TO 4-WIRE FLAT

(With dust cover)



BACK VIEW

PART #
647355 9.15 G

7 RV BLADE TO 4-WIRE FLAT

(Flexible, with dust cover)



PART #
647365 15.60 G

7 RV BLADE TO 5-WIRE FLAT



BACK VIEW

PART #
647375 12.45 G

7-WAY PIN TYPE TO 4-WIRE FLAT



BACK VIEW

PART #
647405 9.30 G

6 POLE ROUND TO 6 POLE SQUARE

(Flexible)



PART #
647415 15.60 G

6 POLE ROUND TO 7 RV BLADE

(Flexible)



PART #
647435 20.05 G

4-WAY ROUND TO 4-WIRE FLAT

(Flexible, with dust cover)



PART #
647465 11.35 G

4-WIRE FLAT TO 5-WIRE FLAT

Adapts vehicles with 4-wire flat to trailers with surge brakes and/or 5-wire flat connection



PART #
647515 9.30 G

7 RV BLADE TO 6 POLE ROUND

Center pin auxiliary (With dust cover)



PART #
647545 14.05 G

7 RV BLADE TO 6 POLE ROUND

Center pin electric brake (With dust cover) **UNIVERSAL** - Center pin can be switched to auxiliary or electric brake

PART #
647555 14.05 G

7 RV BLADE TO 7-WAY PIN TYPE

(Flexible)



PART #
647595 33.05 G

4-WIRE FLAT KNOCKOUT

(For use with 1.25" hole diameter or #648605 bracket, with dust cover)



PART #
647605 6.30 G

FLEX-COIL HEAVY DUTY ADAPTERS



Flex-Coil™ adapters provide the user with increased durability and additional length that may be necessary to reach between the tow vehicle's socket and the trailer/towed vehicle's plug.

In addition, Flex-Coil™ adapters with Nite-Glow™ illuminate upon activation of the taillight function.

This enables the user to find the electrical connection in the dark and show that the vehicle's trailer wiring system is working properly.

7 RV BLADE TO 4-WIRE FLAT NITE-GLOW™



- 3 ft. stretch
- Increased weatherproofing
- Tin-plated terminals
- Easy-grip connectors
- Heavy-duty cable

PART #	MFG #		
647015	47015	41.20	G

7 RV BLADE TO 5-WIRE FLAT NITE-GLOW™



- 3 ft. stretch
- Increased weatherproofing
- Tin-plated terminals
- Easy-grip connectors
- Heavy-duty cable

PART #	MFG #		
647025	47025	49.45	G

4 POLE ROUND TO 4 POLE ROUND NITE-GLOW™



- Great for RVing
- 8 ft. stretch
- Increased weatherproofing
- Tin-plated terminals
- Easy-grip connectors
- Heavy-duty cable

PART #	MFG #		
647045	47045	49.45	G

6 POLE ROUND TO 6 POLE ROUND NITE-GLOW™

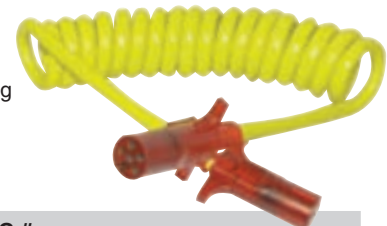

- Great for RVing
- 8 ft. stretch
- Increased weatherproofing
- Tin-plated terminals
- Easy-grip connectors
- Heavy-duty cable

PART #	MFG #		
647055	47055	61.90	G

7 RV BLADE TO 4-WIRE FLAT NITE-GLOW™

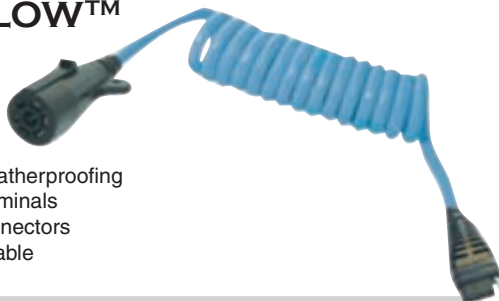

- 3 ft. stretch
- Increased weatherproofing
- Tin-plated terminals
- Easy-grip connectors
- Heavy-duty cable

PART #	MFG #		
647065	47065	38.10	G

7 RV BLADE TO 5-WIRE FLAT NITE-GLOW™



- 3 ft. stretch
- Increased weatherproofing
- Tin-plated terminals
- Easy-grip connectors
- Heavy-duty cable

PART #	MFG #		
647075	47075	46.55	G

7 RV BLADE TO 6 POLE ROUND CENTER PIN AUXILIARY

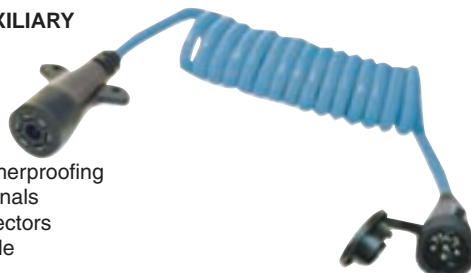

- 3 ft. stretch
- Increased weatherproofing
- Tin-plated terminals
- Easy-grip connectors
- Heavy-duty cable

PART #	MFG #		
647083	47083	62.50	G

7 RV BLADE TO 6 POLE ROUND CENTER PIN ELECTRIC BRAKE

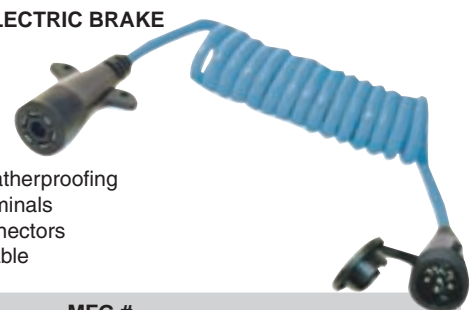

- 3 ft. stretch
- Increased weatherproofing
- Tin-plated terminals
- Easy-grip connectors
- Heavy-duty cable

PART #	MFG #		
647085	47085	62.50	G

- tires & wheels
- axles, hubs & springs
- tongue accessories
- hitches
- electrical
- brake parts
- trailer hardware
- locks & pins
- towing & loading
- tie downs
- tools
- chemicals

TRAILER

PLUG-IN SIMPLE!® VEHICLE SPECIFIC WIRING KIT 4 WIRE FLAT



- tires & wheels
- axles, hubs & springs
- tongue accessories
- hitches
- electrical
- brake parts
- trailer hardware
- locks & pins
- towing & loading
- tie downs
- tools
- chemicals

MODEL	YEAR	PLUG-IN SIMPLE!® VEHICLE SPECIFIC WIRING KIT		
AUDI				
Q5 (with tow package)	09-14	641155	20.50	G
Q7 (with tow package)	07-15	641155	20.50	G
BUICK				
Enclave (with tow package)	08-12	641155	20.50	G
Enclave (with tow package)	13-16	641155	20.50	G
Rainier	04-07	641155	20.50	G
Rendezvous	02-07	641405	20.50	G
CADILLAC				
Escalade	99-00	641125	20.50	G
Escalade	02-06	641155	20.50	G
Escalade / EXT / ESV	07-13	641155	20.50	G
Escalade / EXT / ESV	14-15	641155	20.50	G
CHEVROLET				
Avalanche	02-06	641155	20.50	G
Avalanche (4 pin taillight plug)	07-13	641155	20.50	G
Avalanche (5 pin taillight plug)	07-13	641155	20.50	G
Avalanche (6 pin taillight plug)	07-13	641155	20.50	G
Blazer (full size)	92-94	641125	20.50	G
S-10 Blazer (2 door)	84-91	641205	20.65	B
S-10 Blazer (2 door)	92-94	641215	13.25	B
Colorado	04-07	641165	38.65	G
Colorado (without tow package)	08-12	641165	38.65	G
Colorado (with tow package)	08-12	641155	20.50	G
Colorado (with tow package)	15-16	641155	20.50	G
Express Van (with tow package)	08-16	641155	20.50	G
Pickup (full size)	88-98	641125	20.50	G
Pickup C/K (old body style)	99-00	641125	20.50	G
Silverado 1500 (new body style)	99-02	641145	33.70	G
Silverado 1500	03-07	641155	20.50	G
Silverado 1500 (new body style)	07-13	641155	20.50	G
Silverado 2500/3500 (new body style)	99-02	641155	20.50	G
Silverado 2500/3500	03-07	641155	20.50	G
Silverado 2500/3500 (new body style)	07-13	641155	20.50	G
Silverado 1500, 2500, 3500	14-16	641155	20.50	G
Suburban	92-99	641125	20.50	G
Suburban	00-06	641155	20.50	G
Suburban (4 pin taillight plug)	07-13	641155	20.50	G
Suburban (5 pin taillight plug)	07-13	641155	20.50	G
Suburban (6 pin taillight plug)	07-13	641155	20.50	G
Suburban (4 pin taillight plug)	14	641155	20.50	G
Suburban (5 pin taillight plug)	14	641155	20.50	G
Suburban (6 pin taillight plug)	14	641155	20.50	G
Suburban (4 pin taillight plug)	15	641155	20.50	G
Suburban (5 pin taillight plug)	15	641155	20.50	G
Suburban (6 pin taillight plug)	15	641155	20.50	G
Tahoe	95-99	641125	20.50	G
Tahoe	00-06	641155	20.50	G
Tahoe (4 pin taillight plug)	07-13	641155	20.50	G
Tahoe (5 pin taillight plug)	07-13	641155	20.50	G
Tahoe (6 pin taillight plug)	07-13	641155	20.50	G
Tahoe (4 pin taillight plug)	14	641155	20.50	G
Tahoe (5 pin taillight plug)	14	641155	20.50	G
Tahoe (6 pin taillight plug)	14	641155	20.50	G
Tahoe (4 pin taillight plug)	15	641155	20.50	G
Tahoe (5 pin taillight plug)	15	641155	20.50	G
Tahoe (6 pin taillight plug)	15	641155	20.50	G
Trailblazer	02-09	641155	20.50	G
Traverse (with tow package)	10-16	641155	20.50	G
Venture	97-05	641365	41.85	B
CHRYSLER				
Aspen	07-09	642245	57.05	G
Aspen (with tow package)	07-09	641155	20.50	G
Town & Country	91-95	642205	35.75	G

**PLUG-IN SIMPLE!® VEHICLE SPECIFIC WIRING KIT
4 WIRE FLAT**

MODEL	YEAR	PLUG-IN SIMPLE!® VEHICLE SPECIFIC WIRING KIT		
CHRYSLER CONTINUED				
Town & Country	04-07	642235	36.30	G
DODGE				
Caravan / Grand Caravan	91-95	642205	35.75	G
Caravan / Grand Caravan	04-07	642235	36.30	G
Dakota	87-94	642105	31.25	B
Dakota	04-11	642205	35.75	G
Durango	04-09	642245	57.05	G
Durango (with tow package)	07-15	641155	20.50	G
Journey (with tow package)	09-10	641155	20.50	G
Nitro (with tow package)	07-09	641155	20.50	G
Ram Pickup (all sizes)	87-94	642105	31.25	B
Ram Pickup (cab & chassis only)	95-02	642105	31.25	B
Ram Pickup 1500	02-06	642135	57.05	G
Ram Pickup 1500	07-09	642205	35.75	G
Ram 1500 (with tow package)	10-16	641155	20.50	G
Ram Pickup 2500/3500	03-06	642135	57.05	G
Ram Pickup 2500/3500	07-09	642205	35.75	G
Ram Pickup 2500/3500 (with tow package)	10-16	641155	20.50	G
Ram Promaster (with tow package)	14-16	641155	20.50	G
Ramcharger / Trailduster	88-93	642105	31.25	B
FORD				
Bronco	80-86	640115	20.50	G
Econoline Van (with factory 7 blade)	04-15	641155	20.50	G
Escape (with tow package)	01-04	640445	15.55	G
Escape (with tow package)	05-07	640455	15.55	G
Escape (with tow package)	13-16	641155	20.50	G
Excursion	00-05	641155	20.50	G
Expedition (with factory 7 blade)	99-15	641155	20.50	G
Explorer (with factory 7 blade)	02-16	641155	20.50	G
Explorer Sport Trac (with tow package)	07-10	641155	20.50	G
F-150, 250, 350	80-86	640115	20.50	G
F-150	05-08	640185	29.55	G
F-150 (with tow package)	08-15	641155	20.50	G
F-250 Heavy Duty, F-350	02-04	640165	18.20	G
F-250 Heavy Duty, F-350 (without tow package)	05-07	640195	29.55	G
F-250, 350 (with tow package)	05-16	641155	20.50	G
Flex (with tow package)	09-15	641155	20.50	G
Transit T-150 Van (with tow package)	15-16	641155	20.50	G
Transit T-250 Wagon (with tow package)	15-16	641155	20.50	G
Transit T-350 Wagon XLT (with tow package)	15-16	641155	20.50	G
Windstar	95	640605	39.75	B
Windstar	96-98	640605	39.75	B
GMC				
Acadia (with tow package)	07-16	641155	20.50	G
Canyon	04-07	641165	38.65	G
Canyon (without tow package)	08-12	641165	38.65	G
Canyon (with tow package)	08-12	641155	20.50	G
Canyon (with tow package)	15-16	641155	20.50	G
Denali	99-00	641125	20.50	G
Denali	01-14	641155	20.50	G
Envoy (with tow package)	02-09	641155	20.50	G
Jimmy (full size)	92-94	641125	20.50	G
S-15 Jimmy (2 door)	84-91	641205	20.65	B
S-15 Jimmy (2 door)	92-94	641215	13.25	B
Pickup (full size)	88-98	641125	20.50	G
Pickup (Classic) (old body style)	99-00	641125	20.50	G
Sierra 1500 (new body style)	99-02	641145	33.70	G
Sierra 1500	03-07	641155	20.50	G
Sierra 1500 (new body style)	07-13	641155	20.50	G
Sierra 2500/3500 (new body style)	99-02	641155	20.50	G
Sierra 2500/3500	03-07	641155	20.50	G
Sierra 2500/3500 (new body style)	07-13	641155	20.50	G
Sierra 1500, 2500, 3500	14-16	641155	20.50	G

tires & wheels

axles, hubs & springs

tongue accessories

hitches

electrical

brake parts

trailer hardware

locks & pins

towing & loading

tie downs

tools

chemicals

TRAILER

PLUG-IN SIMPLE!® VEHICLE SPECIFIC WIRING KIT 4 WIRE FLAT



- tires & wheels
- axles, hubs & springs
- tongue accessories
- hitches
- electrical
- brake parts
- trailer hardware
- locks & pins
- towing & loading
- tie downs
- tools
- chemicals

MODEL	YEAR	PLUG-IN SIMPLE!® VEHICLE SPECIFIC WIRING KIT		
GMC CONTINUED				
Suburban	92-99	641125	20.50	G
Savana Van (full size) (with tow package)	08-16	641155	20.50	G
Yukon	92-99	641125	20.50	G
Yukon	00-06	641155	20.50	G
Yukon (4 pin taillight plug)	07-14	641155	20.50	G
Yukon (5 pin taillight plug)	07-14	641155	20.50	G
Yukon (6 pin taillight plug)	07-14	641155	20.50	G
Yukon (4 pin taillight plug)	15	641155	20.50	G
Yukon (5 pin taillight plug)	15	641155	20.50	G
Yukon (6 pin taillight plug)	15	641155	20.50	G
HONDA				
Ridgeline	06-12	643125	51.30	G
Ridgeline	13-14	643125	51.30	G
HUMMER				
H2	03-07	641155	20.50	G
H2 SUT	03-07	641155	20.50	G
H2	08-09	641155	20.50	G
H2 SUT	08-09	641155	20.50	G
H3	06-09	641155	20.50	G
H3 SUT	09	641155	20.50	G
INFINITI				
QX56 (with tow package), QX80	04-15	641155	20.50	G
ISUZU				
Ascender	04-08	641155	20.50	G
I-280	06	641165	38.65	G
I-290	07-08	641165	38.65	G
I-350	06	641165	38.65	G
I-370	07-08	641165	38.65	G
JEEP				
Commander	06-10	642705	84.70	G
Grand Cherokee (early 07)	05-07	642545	77.00	G
Liberty	02-07	642475	55.30	G
Cherokee (with tow package)	14-16	641155	20.50	G
Grand Cherokee (with tow package)	11-15	641155	20.50	G
Liberty (with tow package)	08-10	641155	20.50	G
Wrangler / Renegade	98-04	642615	28.40	G
Wrangler / Renegade	05-06	642625	28.40	G
Wrangler	07-16	642635	28.40	G
KIA				
Borrego (with tow package)	09	641155	20.50	G
Sportage	05-06	643925	51.30	G
LAND ROVER				
Range Rover (with tow package)	13-14	641155	20.50	G
LR4 (with tow package)	13-14	641155	20.50	G
LINCOLN				
Aviator (with factory 7 blade)	03-05	641155	20.50	G
Aviator (with factory 7 blade)	06	641155	20.50	G
Mark LT	06	641155	20.50	G
Mark LT	07-08	641155	20.50	G
MKT (with tow package)	09	641155	20.50	G
MKT (with tow package)	10-11	641155	20.50	G
MKT (with tow package)	12-14	641155	20.50	G
Navigator (with tow package)	99-12	641155	20.50	G
Navigator (with tow package)	13-15	641155	20.50	G
MAZDA				
Tribute (with tow package)	01-04	640445	15.55	G
Tribute (with tow package)	05-06	640455	15.55	G
MERCEDES BENZ				
M Class (with tow package)	98-05	641155	20.50	G
M Class (with tow package)	06-08	641155	20.50	G
M Class (with tow package)	09-14	641155	20.50	G

**PLUG-IN SIMPLE!® VEHICLE SPECIFIC WIRING KIT
4 WIRE FLAT**

MODEL	YEAR	PLUG-IN SIMPLE!® VEHICLE SPECIFIC WIRING KIT		
MERCURY				
Mariner (with tow package)	05-07	640455	15.55	G
Mountaineer (with factory 7 blade)	02-10	641155	20.50	G
MITSUBISHI				
Raider	06-08	642205	35.75	G
NISSAN				
Armada	04-15	641155	20.50	G
Frontier Pickup	98-03	643515	51.45	G
Frontier Pickup	04	643515	51.45	G
Frontier Pickup (with factory 4 flat)	05-11	643575	15.55	G
Pathfinder (with tow package)	05-09	643575	15.55	G
Pathfinder (with tow package)	13-15	641155	20.50	G
Titan	04-16	641155	20.50	G
Xterra	00-03	643595	15.55	G
Xterra	04	643595	15.55	G
Xterra	05-08	643605	75.85	G
Xterra (with factory 4 flat)	05-15	643575	15.55	G
OLDSMOBILE				
Bravada	02-04	641155	20.50	G
Silhouette	97-05	641365	41.85	B
PLYMOUTH				
Voyager / Grand Voyager	91-95	642205	35.75	G
PONTIAC				
Aztek	01-05	641405	20.50	G
Montana	97-06	641365	41.85	B
Trans Sport Van	97-04	641365	41.85	B
PORSCHE				
Cayenne (with tow package)	13-14	641155	20.50	G
RAM				
Ram 1500 (with tow package)	10-16	641155	20.50	G
Ram Pickup 2500/3500 (with tow package)	10-16	641155	20.50	G
Ram Promaster (with tow package)	14-15	641155	20.50	G
SAAB				
9-7X	05-10	641155	20.50	G
SATURN				
Outlook (with tow package)	07-10	641155	20.50	G
SUBARU				
B9 Tribeca	06-16	643855	92.35	G
Forester	98-08	643855	92.35	G
Impreza (Sedan)	02-07	643855	92.35	G
Legacy	03-08	643855	92.35	G
Outback	96-08	643855	92.35	G
SUZUKI				
Equator (with factory 4 flat)	09-12	643575	15.55	G
TOYOTA				
Pickup (except T-100)	84-95	643315	45.95	G
Sequoia (with tow package)	10-12	620415, 640955, 640965, 640975		
Sequoia (with tow package)	10-12	641155	20.50	G
Sequoia (with tow package)	13-14	620415, 640955, 640965, 640975		
Sequoia (with tow package)	13-14	641155	20.50	G
Tacoma	95-04	643315	45.95	G
Tacoma (without tow package)	05-08	643355	67.45	G
Tacoma (without tow package)	14-15	643355	67.45	G
T-100	93-98	643355	67.45	G
Tundra (with tow package)	03-06	643385	37.60	G
Tundra (with factory 7 blade)	14-15	641155	20.50	G
VOLKSWAGEN				
Touareg (with tow package)	12-15	641155	20.50	G

tires & wheels

axles, hubs & springs

tongue accessories

hitches

electrical

brake parts

trailer hardware

locks & pins

towing & loading

tie downs

tools

chemicals

TRAILER

PLUG-IN SIMPLE![®] BACKUP CAMERA



- tires & wheels
- axles, hubs & springs
- tongue accessories
- hitches
- electrical**
- brake parts
- trailer hardware
- locks & pins
- towing & loading
- tie downs
- tools
- chemicals

TRAILER

MODEL	YEAR	PLUG-IN SIMPLE! [®] CAMERA		
CADILLAC				
Escalade	02-06	620414	198.95	G
Escalade	02-06	620414	198.95	G
Escalade / EXT / ESV	07-13	620414	198.95	G
Escalade / EXT / ESV	07-13	620414	198.95	G
Escalade / EXT / ESV	14	620414	198.95	G
Escalade / EXT / ESV	14	620414	198.95	G
Escalade / EXT / ESV	15	620414	198.95	G
Escalade / EXT / ESV	15	620414	198.95	G
CHEVROLET				
Avalanche	02-06	620414	198.95	G
Avalanche	02-06	620414	198.95	G
Avalanche (4 pin taillight plug)	07-13	620414	198.95	G
Avalanche (4 pin taillight plug)	07-13	620414	198.95	G
Avalanche (5 pin taillight plug)	07-13	620414	198.95	G
Avalanche (5 pin taillight plug)	07-13	620414	198.95	G
Avalanche (6 pin taillight plug)	07-13	620414	198.95	G
Avalanche (6 pin taillight plug)	07-13	620414	198.95	G
Colorado (with tow package)	08-12	620414	198.95	G
Colorado (with tow package)	08-12	620414	198.95	G
Colorado (with tow package)	15-16	620414	198.95	G
Colorado (with tow package)	15-16	620414	198.95	G
Silverado 1500	03-07	620414	198.95	G
Silverado 1500	03-07	620414	198.95	G
Silverado 1500 (new body style)	07-13	620414	198.95	G
Silverado 1500 (new body style)	07-13	620414	198.95	G
Silverado 2500/3500 (new body style)	99-02	620414	198.95	G
Silverado 2500/3500 (new body style)	99-02	620414	198.95	G
Silverado 2500/3500	03-07	620414	198.95	G
Silverado 2500/3500	03-07	620414	198.95	G
Silverado 2500/3500 (new body style)	07-13	620414	198.95	G
Silverado 2500/3500 (new body style)	07-13	620414	198.95	G
Silverado 1500, 2500, 3500	14-16	620414	198.95	G
Silverado 1500, 2500, 3500	14-16	620414	198.95	G
Suburban	00-02	620414	198.95	G
Suburban	00-02	620414	198.95	G
Suburban	03-06	620414	198.95	G
Suburban	03-06	620414	198.95	G
Suburban (4 pin taillight plug)	07-13	620414	198.95	G
Suburban (4 pin taillight plug)	07-13	620414	198.95	G
Suburban (5 pin taillight plug)	07-13	620414	198.95	G
Suburban (5 pin taillight plug)	07-13	620414	198.95	G
Suburban (6 pin taillight plug)	07-13	620414	198.95	G
Suburban (6 pin taillight plug)	07-13	620414	198.95	G
Suburban (4 pin taillight plug)	14	620414	198.95	G
Suburban (4 pin taillight plug)	14	620414	198.95	G
Suburban (5 pin taillight plug)	14	620414	198.95	G
Suburban (5 pin taillight plug)	14	620414	198.95	G
Suburban (6 pin taillight plug)	14	620414	198.95	G
Suburban (6 pin taillight plug)	14	620414	198.95	G
Suburban (4 pin taillight plug)	15	620414	198.95	G
Suburban (4 pin taillight plug)	15	620414	198.95	G
Suburban (5 pin taillight plug)	15	620414	198.95	G
Suburban (5 pin taillight plug)	15	620414	198.95	G
Suburban (6 pin taillight plug)	15	620414	198.95	G
Suburban (6 pin taillight plug)	15	620414	198.95	G
Tahoe	00-02	620414	198.95	G
Tahoe	00-02	620414	198.95	G
Tahoe	03-06	620414	198.95	G
Tahoe	03-06	620414	198.95	G
Tahoe (4 pin taillight plug)	07-13	620414	198.95	G
Tahoe (4 pin taillight plug)	07-13	620414	198.95	G
Tahoe (5 pin taillight plug)	07-13	620414	198.95	G

PLUG-IN SIMPLE!® BACKUP CAMERA



MODEL	YEAR	PLUG-IN SIMPLE!® CAMERA	
CHEVROLET CONTINUED			
Tahoe (5 pin taillight plug)	07-13	620414	198.95 G
Tahoe (6 pin taillight plug)	07-13	620414	198.95 G
Tahoe (6 pin taillight plug)	07-13	620414	198.95 G
Tahoe (4 pin taillight plug)	14	620414	198.95 G
Tahoe (4 pin taillight plug)	14	620414	198.95 G
Tahoe (5 pin taillight plug)	14	620414	198.95 G
Tahoe (5 pin taillight plug)	14	620414	198.95 G
Tahoe (6 pin taillight plug)	14	620414	198.95 G
Tahoe (6 pin taillight plug)	14	620414	198.95 G
Tahoe (4 pin taillight plug)	15	620414	198.95 G
Tahoe (4 pin taillight plug)	15	620414	198.95 G
Tahoe (5 pin taillight plug)	15	620414	198.95 G
Tahoe (5 pin taillight plug)	15	620414	198.95 G
Tahoe (6 pin taillight plug)	15	620414	198.95 G
Tahoe (6 pin taillight plug)	15	620414	198.95 G
DODGE			
Ram 1500 (with tow package)	10-12	620414	198.95 G
Ram 1500 (with tow package)	10-12	620414	198.95 G
Ram 1500 (with tow package)	13-14	620414	198.95 G
Ram 1500 (with tow package)	13-14	620414	198.95 G
Ram 1500 (with tow package)	15-16	620414	198.95 G
Ram 1500 (with tow package)	15-16	620414	198.95 G
Ram Pickup 2500/3500 (with tow package)	10-12	620414	198.95 G
Ram Pickup 2500/3500 (with tow package)	10-12	620414	198.95 G
Ram Pickup 2500/3500 (with tow package)	13-14	620414	198.95 G
Ram Pickup 2500/3500 (with tow package)	13-14	620414	198.95 G
Ram Pickup 2500/3500 (with tow package)	15-16	620414	198.95 G
Ram Pickup 2500/3500 (with tow package)	15-16	620414	198.95 G
FORD			
Excursion	00-05	620414	198.95 G
Excursion	00-05	620414	198.95 G
Explorer (with factory 7 blade)	14-16	620414	198.95 G
Explorer (with factory 7 blade)	14-16	620414	198.95 G
Explorer Sport Trac (with tow package)	07-10	620414	198.95 G
Explorer Sport Trac (with tow package)	07-10	620414	198.95 G
F-150 (with tow package)	08	620414	198.95 G
F-150 (with tow package)	08	620414	198.95 G
F-150 (with tow package)	09-14	620414	198.95 G
F-150 (with tow package)	09-14	620414	198.95 G
F-150 (with tow package)	15	620414	198.95 G
F-150 (with tow package)	15	620414	198.95 G
F-250, 350 (with tow package)	05-07	620414	198.95 G
F-250, 350 (with tow package)	05-07	620414	198.95 G
F-250, 350 (with tow package)	08-16	620414	198.95 G
F-250, 350 (with tow package)	08-16	620414	198.95 G
Flex (with tow package)	09-11	620414	198.95 G
Flex (with tow package)	09-11	620414	198.95 G
Flex (with tow package)	12-14	620414	198.95 G
Flex (with tow package)	12-14	620414	198.95 G
GMC			
Canyon (with tow package)	08-12	620414	198.95 G
Canyon (with tow package)	08-12	620414	198.95 G
Canyon (with tow package)	15-16	620414	198.95 G
Canyon (with tow package)	15-16	620414	198.95 G
Denali	01-06	620414	198.95 G
Denali	01-06	620414	198.95 G
Denali	07-13	620414	198.95 G
Denali	07-13	620414	198.95 G
Denali	14	620414	198.95 G
Denali	14	620414	198.95 G
Sierra 1500	03-07	620414	198.95 G
Sierra 1500	03-07	620414	198.95 G

tires & wheels

axles, hubs & springs

tongue accessories

hitches

electrical

brake parts

trailer hardware

locks & pins

towing & loading

tie downs

tools

chemicals

TRAILER

PLUG-IN SIMPLE![®] BACKUP CAMERA



- tires & wheels
- axles, hubs & springs
- tongue accessories
- hitches
- electrical
- brake parts
- trailer hardware
- locks & pins
- towing & loading
- tie downs
- tools
- chemicals

TRAILER

MODEL	YEAR	PLUG-IN SIMPLE! [®] CAMERA	
GMC CONTINUED			
Sierra 1500 (new body style)	07-13	620414	198.95 G
Sierra 1500 (new body style)	07-13	620414	198.95 G
Sierra 2500/3500 (new body style)	99-02	620414	198.95 G
Sierra 2500/3500 (new body style)	99-02	620414	198.95 G
Sierra 2500/3500	03-07	620414	198.95 G
Sierra 2500/3500	03-07	620414	198.95 G
Sierra 2500/3500 (new body style)	07-13	620414	198.95 G
Sierra 2500/3500 (new body style)	07-13	620414	198.95 G
Sierra 1500, 2500, 3500	14-16	620414	198.95 G
Sierra 1500, 2500, 3500	14-16	620414	198.95 G
Savana Van (full size) (with tow package)	08-16	620414	198.95 G
Savana Van (full size) (with tow package)	08-16	620414	198.95 G
Yukon	00-06	620414	198.95 G
Yukon	00-06	620414	198.95 G
Yukon (4 pin taillight plug)	07-14	620414	198.95 G
Yukon (4 pin taillight plug)	07-14	620414	198.95 G
Yukon (5 pin taillight plug)	07-14	620414	198.95 G
Yukon (5 pin taillight plug)	07-14	620414	198.95 G
Yukon (6 pin taillight plug)	07-14	620414	198.95 G
Yukon (6 pin taillight plug)	07-14	620414	198.95 G
Yukon (4 pin taillight plug)	15	620414	198.95 G
Yukon (4 pin taillight plug)	15	620414	198.95 G
Yukon (5 pin taillight plug)	15	620414	198.95 G
Yukon (5 pin taillight plug)	15	620414	198.95 G
Yukon (6 pin taillight plug)	15	620414	198.95 G
Yukon (6 pin taillight plug)	15	620414	198.95 G
LINCOLN			
Mark LT	06	620414	198.95 G
Mark LT	06	620414	198.95 G
Mark LT	07-08	620414	198.95 G
Mark LT	07-08	620414	198.95 G
NISSAN			
Armada	04-15	620414	198.95 G
Armada	04-15	620414	198.95 G
Titan	04-16	620414	198.95 G
Titan	04-16	620414	198.95 G
RAM			
Ram 1500 (with tow package)	10-12	620414	198.95 G
Ram 1500 (with tow package)	10-12	620414	198.95 G
Ram 1500 (with tow package)	13-14	620414	198.95 G
Ram 1500 (with tow package)	13-14	620414	198.95 G
Ram 1500 (with tow package)	15-16	620414	198.95 G
Ram 1500 (with tow package)	15-16	620414	198.95 G
Ram Pickup 2500/3500 (with tow package)	10-12	620414	198.95 G
Ram Pickup 2500/3500 (with tow package)	10-12	620414	198.95 G
Ram Pickup 2500/3500 (with tow package)	13-14	620414	198.95 G
Ram Pickup 2500/3500 (with tow package)	13-14	620414	198.95 G
Ram Pickup 2500/3500 (with tow package)	15-16	620414	198.95 G
Ram Pickup 2500/3500 (with tow package)	15-16	620414	198.95 G
TOYOTA			
Tundra (with factory 7 blade)	14-15	620414	198.95 G
Tundra (with factory 7 blade)	14-15	620414	198.95 G

PLUG-IN SIMPLE![®] MULTI-TOW

MODEL	YEAR	PLUG-IN SIMPLE! [®] VEHICLE SPECIFIC WIRING KIT
AUDI		
Q3 (with tow package)	09-15	620415, 640955, 640965, 640975
Q5 (with tow package)	09-14	620415, 640955, 640965, 640975
Q7 (with tow package)	07-15	620415, 640955, 640965, 640975
BUICK		
Enclave (with tow package)	08-12	640975
Enclave (with tow package)	13-16	620412, 620415, 640955, 640965, 640975
Rainier	04-07	620412, 620415, 640955, 640965, 640975
CADILLAC		
Escalade	02-06	620415, 640955, 640965, 640975
Escalade / EXT / ESV	07-13	620415, 640955, 640965, 640975
Escalade / EXT / ESV	14-15	620412, 620415, 640955, 640965, 640975
CHEVROLET		
Avalanche	02-06	620412, 620415, 640955, 640965, 640975
Avalanche (4 pin taillight plug)	07-13	620412, 620415, 640955, 640965, 640975
Avalanche (5 pin taillight plug)	07-13	620412, 620415, 640955, 640965, 640975
Avalanche (6 pin taillight plug)	07-13	620412, 620415, 640955, 640965, 640975
Colorado (with tow package)	08-12	620415, 640955, 640965, 640975
Colorado (with tow package)	15-16	620415, 640955, 640965, 640975
Express Van (with tow package)	08-16	620415, 640955, 640965, 640975
Silverado 1500	03-07	620412, 620415, 640955, 640965, 640975
Silverado 1500 (new body style)	07-13	620412, 620415, 640955, 640965, 640975
Silverado 2500/3500 (new body style)	99-02	620412, 620415, 640955, 640965, 640975
Silverado 2500/3500	03-07	620412, 620415, 640955, 640965, 640975
Silverado 2500/3500 (new body style)	07-13	620412, 620415, 640955, 640965, 640975
Silverado 1500, 2500, 3500	14-16	620415, 640955, 640965, 640975
Suburban	00-06	620412, 620415, 640955, 640965, 640975
Suburban (4 pin taillight plug)	07-13	620412, 620415, 640955, 640965, 640975
Suburban (5 pin taillight plug)	07-13	620412, 620415, 640955, 640965, 640975
Suburban (6 pin taillight plug)	07-13	620412, 620415, 640955, 640965, 640975
Suburban (4 pin taillight plug)	14	620412, 620415, 640955, 640965, 640975
Suburban (5 pin taillight plug)	14	620412, 620415, 640955, 640965, 640975
Suburban (6 pin taillight plug)	14	620412, 620415, 640955, 640965, 640975
Suburban (4 pin taillight plug)	15	620412, 620415, 640955, 640965, 640975
Suburban (5 pin taillight plug)	15	620412, 620415, 640955, 640965, 640975
Suburban (6 pin taillight plug)	15	620412, 620415, 640955, 640965, 640975
Tahoe	00-06	620415, 640955, 640965, 640975
Tahoe (4 pin taillight plug)	07-13	620412, 620415, 640955, 640965, 640975
Tahoe (5 pin taillight plug)	07-13	620412, 620415, 640955, 640965, 640975
Tahoe (6 pin taillight plug)	07-13	620412, 620415, 640955, 640965, 640975
Tahoe (4 pin taillight plug)	14	620412, 620415, 640955, 640965, 640975
Tahoe (5 pin taillight plug)	14	620412, 620415, 640955, 640965, 640975
Tahoe (6 pin taillight plug)	14	620412, 620415, 640955, 640965, 640975
Tahoe (4 pin taillight plug)	15	620412, 620415, 640955, 640965, 640975
Tahoe (5 pin taillight plug)	15	620412, 620415, 640955, 640965, 640975
Tahoe (6 pin taillight plug)	15	620412, 620415, 640955, 640965, 640975
Trailblazer	02-09	620412, 620415, 640955, 640965, 640975
Traverse (with tow package)	10-12	620415, 640955, 640965, 640975
Traverse (with tow package)	13-16	620412, 620415, 640955, 640965, 640975
CHRYSLER		
Aspen (with tow package)	Early 07	642145, 620416
Aspen (with tow package)	07-09	620415, 640955, 640965, 640975
Pacifica (with tow package)	03-08	642145, 620416
DODGE		
Dakota (with tow package)	00-10	642145, 620416
Durango (with tow package) (early 07)	00-07	642145, 620416
Durango (with tow package)	07-15	620415, 640955, 640965, 640975
Journey (with tow package)	09-10	620415, 640955, 640965, 640975
Nitro (with tow package)	07-09	620415, 640955, 640965, 640975
Ram 1500 (with tow package)	00-09	642145, 620416
Ram 1500 (with tow package)	10-16	620415, 640955, 640965, 640975
Ram Pickup 2500/3500 (with tow package)	00-09	642145, 620416

tires & wheels

axles, hubs & springs

tongue accessories

hitches

electrical

brake parts

trailer hardware

locks & pins

towing & loading

tie downs

tools

chemicals

TRAILER

PLUG-IN SIMPLE!® MULTI-TOW



- tires & wheels
- axles, hubs & springs
- tongue accessories
- hitches
- electrical
- brake parts
- trailer hardware
- locks & pins
- towing & loading
- tie downs
- tools
- chemicals

TRAILER

MODEL	YEAR	PLUG-IN SIMPLE!® VEHICLE SPECIFIC WIRING KIT
DODGE CONTINUED		
Ram Pickup 2500/3500 (with tow package)	10-16	620415, 640955, 640965, 640975
Ram Promaster (with tow package)	14-16	620415, 640955, 640965, 640975
Ram Van	01-03	642145, 620416
Sprinter (with tow package)	04-08	642145, 620416
Sprinter 2500	09	642145, 620416
Sprinter 3500	09	642145, 620416
FORD		
Econoline Van (with factory 7 blade)	04-15	620415, 640955, 640965, 640975
Escape (with tow package)	13-16	620415, 640955, 640965, 640975
Excursion	00-05	620415, 640955, 640965, 640975
Expedition (with factory 7 blade)	99-15	620415, 640955, 640965, 640975
Explorer (with factory 7 blade)	02-16	620415, 640955, 640965, 640975
Explorer Sport Trac (with tow package)	07-10	620415, 640955, 640965, 640975
F-150 (with tow package)	08-15	620415, 640955, 640965, 640975
F-250, 350 (with tow package)	05-16	620415, 640955, 640965, 640975
Flex (with tow package)	09-15	620415, 640955, 640965, 640975
Transit T-150 Van (with tow package)	15-16	620415, 640955, 640965, 640975
Transit T-250 Wagon (with tow package)	15-16	620415, 640955, 640965, 640975
Transit T-350 Wagon XLT (with tow package)	15-16	620415, 640955, 640965, 640975
GMC		
Acadia (with tow package)	07-12	620415, 640955, 640965, 640975
Acadia (with tow package)	13-16	620412, 620415, 640955, 640965, 640975
Canyon (with tow package)	08-12	620415, 640955, 640965, 640975
Canyon (with tow package)	15-16	620415, 640955, 640965, 640975
Denali	01-14	620412, 620415, 640955, 640965, 640975
Envoy (with tow package)	02-09	620412, 620415, 640955, 640965, 640975
Sierra 1500	03-07	620412, 620415, 640955, 640965, 640975
Sierra 1500 (new body style)	07-13	620412, 620415, 640955, 640965, 640975
Sierra 2500/3500 (new body style)	99-02	620412, 620415, 640955, 640965, 640975
Sierra 2500/3500	03-07	620412, 620415, 640955, 640965, 640975
Sierra 2500/3500 (new body style)	07-13	620412, 620415, 640955, 640965, 640975
Sierra 1500, 2500, 3500	14-16	620415, 640955, 640965, 640975
Savana Van (full size) (with tow package)	08-16	620415, 640955, 640965, 640975
Yukon	00-06	620412, 620415, 640955, 640965, 640975
Yukon (4 pin taillight plug)	07-14	620412, 620415, 640955, 640965, 640975
Yukon (5 pin taillight plug)	07-14	620412, 620415, 640955, 640965, 640975
Yukon (6 pin taillight plug)	07-14	620412, 620415, 640955, 640965, 640975
Yukon (4 pin taillight plug)	15	620412, 620415, 640955, 640965, 640975
Yukon (5 pin taillight plug)	15	620412, 620415, 640955, 640965, 640975
Yukon (6 pin taillight plug)	15	620412, 620415, 640955, 640965, 640975
HUMMER		
H2	03-07	620415, 640955, 640965, 640975
H2 SUT	03-07	620415, 640955, 640965, 640975
H2	08-09	620415, 640955, 640965, 640975
H2 SUT	08-09	620415, 640955, 640965, 640975
H3	06-09	620415, 640955, 640965, 640975
H3 SUT	09	620415, 640955, 640965, 640975
INFINITI		
QX56 (with tow package), QX80	04-15	620415, 640955, 640965, 640975
ISUZU		
Ascender	04-08	620412, 620415, 640955, 640965, 640975
JEEP		
Cherokee (with tow package)	14-16	620415, 640955, 640965, 640975
Commander (with tow package)	06-10	642145, 620416
Grand Cherokee (with tow package)	00-04	642145, 620416
Grand Cherokee (with tow package) (early 07)	05-07	642145, 620416
Grand Cherokee (with tow package)	07-10	642145, 620416
Grand Cherokee (with tow package)	11-15	620415, 640955, 640965, 640975
Liberty (with tow package)	04-07	642145, 620416
Liberty (with tow package)	08-10	620415, 640955, 640965, 640975
Wrangler / Renegade (with tow package)	04-16	642145, 620416

PLUG-IN SIMPLE![®] MULTI-TOW

MODEL	YEAR	PLUG-IN SIMPLE! [®] VEHICLE SPECIFIC WIRING KIT
KIA		
Borrego (with tow package)	09	620415, 640955, 640965, 640975
LAND ROVER		
Range Rover (with tow package)	13-14	620415, 640955, 640965, 640975
LR4 (with tow package)	13-14	620415, 640955, 640965, 640975
LINCOLN		
Aviator (with factory 7 blade)	03-05	620415, 640955, 640965, 640975
Aviator (with factory 7 blade)	06	620415, 640955, 640965, 640975
Mark LT	06	620415, 640955, 640965, 640975
Mark LT	07-08	620415, 640955, 640965, 640975
MKT (with tow package)	09	620415, 640955, 640965, 640975
MKT (with tow package)	10-11	620415, 640955, 640965, 640975
MKT (with tow package)	12-14	620415, 640955, 640965, 640975
Navigator (with tow package)	99-12	620415, 640955, 640965, 640975
Navigator (with tow package)	13-15	620415, 640955, 640965, 640975
MERCEDES BENZ		
GL Class (with tow package)	07-10	642145, 620416
M Class (with tow package)	98-05	620415, 640955, 640965, 640975
M Class (with tow package)	06-14	620415, 640955, 640965, 640975
MERCURY		
Mountaineer (with factory 7 blade)	02-10	620415, 640955, 640965, 640975
MINI		
Raider (with tow package)	06-08	642145, 620416
NISSAN		
Armada	04-15	620415, 640955, 640965, 640975
Pathfinder (with tow package)	13-15	620415, 640955, 640965, 640975
Titan	04-16	620415, 640955, 640965, 640975
OLDSMOBILE		
Bravada	02-04	620412, 620415, 640955, 640965, 640975
PORSCHE		
Cayenne (with tow package)	13-14	620415, 640955, 640965, 640975
RAM		
Ram 1500 (with tow package)	10-16	620415, 640955, 640965, 640975
Ram Pickup 2500/3500 (with tow package)	10-16	620415, 640955, 640965, 640975
Ram Promaster (with tow package)	14-15	620415, 640955, 640965, 640975
Ram Tradesman Van (with tow package)	14-15	642145, 620416
SAAB		
9-7X	05-10	620412, 620415, 640955, 640965, 640975
SATURN		
Outlook (with tow package)	07-10	620412, 620415, 640955, 640965, 640975
TOYOTA		
Sequoia (with tow package)	03-04	620421
Tundra (with factory 7 blade)	07-12	643395
Tundra (with factory 7 blade)	13	643395
Tundra (with factory 7 blade)	14-15	620415, 640955, 640965, 640975
VOLKSWAGEN		
Touareg (with tow package)	12-15	620415, 640955, 640965, 640975

tires & wheels

axles, hubs & springs

tongue accessories

hitches

electrical

brake parts

trailer hardware

locks & pins

towing & loading

tie downs

tools

chemicals

TRAILER

BASIC WIRING SOLUTIONS



ENDURANCE™

PROFESSIONAL WIRING SERIES

Maximum Durability

Superior Ergonomics

3-Year Warranty
Industry's Best

VEHICLE SIDE

- Reinforced easy-grip lid
- Lid opens 180 degrees for easier connections
- Internal seals for ultimate weatherproofing
- Long life oversized hinge
- Mounting bracket, hardware, and terminal grease packet included

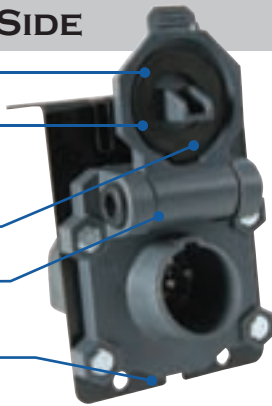

TRAILER SIDE

- Ergonomic pistol grip
- Corrosion resistant terminals
- Mounting bracket, hardware, and terminal grease packet included

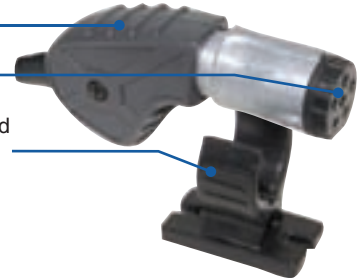

7 RV BLADE



6 POLE ROUND



7 RV BLADE



6 POLE ROUND



PART #

648480

15.20 G

PART #

648420

15.10 G

PART #

648500

14.45 G

PART #

648440

13.30 G

TRAILER

MULTI-TOW® CONNECTOR 7 RV BLADE, 5 AND 4 WIRE FLAT

- Industry's best, 3 year warranty with maximum durability and superior ergonomics
- Oversized hinge and reinforced easy-grip lid opens 180 degrees for easier connections
- Best corrosion resistance, internal seals and rear cover for ultimate weatherproofing



ENDURANCE™

PART #

648470

MFG #

47840

29.65 G

4 WIRE FLAT Y-HARNESS (20 FT.)

- Wishbone design allows for wire extension to both taillights
- Heavy duty connector housings with easy-pull grip and built-in mounting holes
- Protective nylon wire sleeving, heat-shrink tubing and serrated ground terminal for proper grounding



ENDURANCE™

PART #

648240

MFG #

47840

22.05 G

5 WIRE FLAT VEHICLE AND TRAILER CONNECTORS

- Industry's best, 3 year warranty with maximum durability and superior ergonomics
- Heavy duty connector housings with easy-pull grip and built-in mounting holes
- Protective nylon wire sleeving and heat-shrink tubing



PART # DESCRIPTION

647900 Vehicle End - 48" (A) 11.90 G

647910 Trailer End - 18" (B) 9.45 G

647890 Set - 1 each 18.95 G



ACCESSORIES

6 POLE MOLDED TRAILER CABLE



(6-14 gauge wires.)

PART #	LENGTH		
620033	4 Feet	23.55	G
620034	6 Feet	29.40	G
620038	11 Feet	38.80	G

7 RV BLADE MOLDED TRAILER CABLE



(2-10 gauge; 1-12 gauge; 4-14 gauge wires.)

PART #	LENGTH		
620042	3 Feet	23.55	G
620044	6 Feet	35.30	G
620048	11 Feet	51.00	G

7 RV BLADE MOLDED TRAILER CABLE



(With retail packaging. 2-10 gauge; 1-12 gauge; 4-14 gauge wires.)

PART #	LENGTH		
620244	6 Feet	38.85	G
620248	11 Feet	54.90	G

3/8" CONVOLUTED TUBING 10'

- Plastic sheathing protects wires from the elements
- Easily slips over wires
- 10 feet



PART #	LENGTH		
639035	10 Feet	4.80	G

1/2" CONVOLUTED TUBING 7'

- Plastic sheathing protects wires from the elements
- Easily slips over wires
- 7 feet



PART #	LENGTH		
639045	7 Feet	4.80	G

4, 5, 6, POLE, KNOCKOUT MOUNTING BRACKET



PART #	DESCRIPTION		
648605	Mounting Bracket	4.40	G

MAG-FLAT™ BRACKET

- Magnetic bracket keeps 4-wire flat out of harm's way
- Attaches to any metal surface



PART #	DESCRIPTION		
648095	Mag-Flat™	5.05	G

7, 9 POLE MOUNTING BRACKET



PART #	DESCRIPTION		
648615	Mounting Bracket	3.85	G

4-WIRE FLAT MOUNTING BRACKET

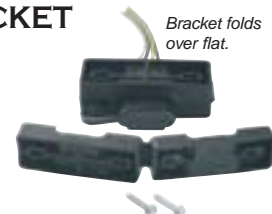

PART #	DESCRIPTION		
648595	Mounting Bracket	3.85	G

4-WIRE FLAT WEATHERPROOF DUST COVERS

Includes 2 tow vehicle end dust covers and terminal grease packet.



PART #	DESCRIPTION		
648735	4-Wire Flat - Pair	2.85	G

FLAT-LITE™ 4-WIRE FLAT LED DUST COVER

Tests left turn/brake, right turn/brake and tail/marker lights.



PART #	DESCRIPTION		
648675	Dust Cover	5.55	G

4-WIRE FLAT MOUNTING BOX

Neatly stores the 4-wire flat out of harm's way.



PART #	DESCRIPTION		
648755	Mounting Box	5.55	G

4-WIRE FLAT TESTER



With LED indicator lights. Tests left turn/brake, right turn/brake and tail/ marker lights. Red LED light will glow if connection is correct.

PART #	DESCRIPTION		
648655	Flat Tester	5.60	G

4-WIRE FLAT TESTER WITH 6 TO 12-VOLT CIRCUIT TESTER

With LED indicator lights. Tests left turn/brake, right turn/brake and tail/ marker lights. Red LED light will glow if connection is correct.



◀ 4-wire flat tester and 6 to 12-volt circuit tester also available separately ▶

PART #	DESCRIPTION		
648715	Flat/Circuit Testers	8.50	G

6 TO 12-VOLT CIRCUIT TESTER

- L.E.D. lights up when power is found
- Alligator clip for easy attachment
- Multi-use application



PART #	DESCRIPTION		
648705	Circuit Tester	3.90	G

- tires & wheels
- axles, hubs & springs
- tongue accessories
- hitches
- electrical
- brake parts
- trailer hardware
- locks & pins
- towing & loading
- tie downs
- tools
- chemicals

TRAILER

ELECTRICAL

ALL PRODUCT SHOWN IS RETAIL READY AND ALL WIRES ARE COLOR CODED

4-WIRE FLAT CONNECTORS



4-WIRE VEHICLE END

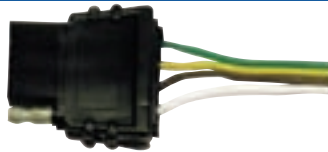

PART #	LENGTH	MANUFACTURER		
648015	12"	Hopkins	2.85	G
648035	48"	Hopkins	3.45	G
OP242	48"	Optronics	4.75	G
PM5400B	48"	Peterson	8.95	G

4-WIRE TRAILER END

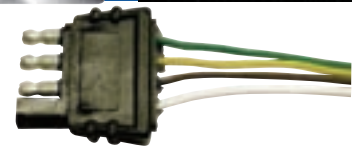

PART #	LENGTH	MANUFACTURER		
648115	12"	Hopkins	2.45	G
648135	48"	Hopkins	4.60	G
PM5400A	12"	Peterson	6.95	G

4-WIRE EXTENSION



PART #	LENGTH	MANUFACTURER		
648145	12"	Hopkins	6.10	G
647115	48"	Hopkins	9.05	G
PM5401	30"	Peterson	14.95	G

4-WIRE TRAILER "Y" HARNESS



PART #	LENGTH	MANUFACTURER		
648245	20'	Hopkins	17.00	G
648255	25'	Hopkins	18.50	G
648265	30'	Hopkins	21.55	G
OP250	25'	Optronics	17.35	G
PM5425	25'	Peterson	25.95	G

5-WIRE FLAT CONNECTORS



5-WIRE VEHICLE END

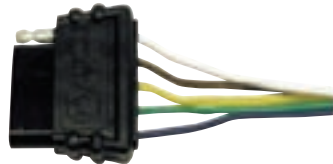

PART #	LENGTH	MANUFACTURER		
647905	48"	Hopkins	9.30	G
OP252	48"	Optronics	4.95	G

5-WIRE TRAILER END

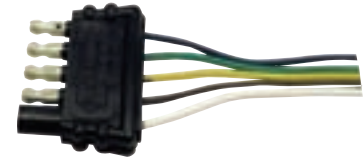

PART #	LENGTH	MANUFACTURER		
647915	18"	Hopkins	8.10	G

5-WIRE TRAILER "Y" HARNESS

PART #	LENGTH	MANUFACTURER		
OP255	25'	Optronics	18.25	G



4-WIRE MATCHED SET

- 1 each 48" vehicle end & 12" trailer end
- Clamshell packaged



PART # 648215	18.25	G
---------------	-------	---

5-WIRE MATCHED SET

- 1 each 48" vehicle end & 18" trailer end
- Clamshell packaged



PART # 647895	15.25	G
---------------	-------	---

TRAILER

tires & wheels
axles, hubs & springs
tongue accessories
hitches
electrical
brake parts
trailer hardware
locks & pins
towing & loading
tie downs
tools
chemicals

BASIC WIRING SOLUTIONS • 4-WIRE FLATS



A 4-wire flat is the most commonly used trailer plug. This plug is found on small boat, utility, jet ski, snowmobile and small camper trailers where right turn/brake, left turn/brake, tail/marker lights and ground is needed.

4-WIRE FLAT EXTENSIONS

- ◆ **32" 4-WIRE FLAT MODULAR REPLACEMENT** This unit is included in most T-connector kits. Utilizes an exterior vehicle frame ground.

PART # 647105	8.95	G
---------------	------	---
- ◆ **48" 4-WIRE FLAT EXTENSION** Extends wiring system 48" for more flexibility. Passes through vehicle ground.

PART # 647115	9.05	G
---------------	------	---
- ◆ **12" 4-WIRE FLAT EXTENSION**

PART # 648145	6.10	G
---------------	------	---
- ◆ **10 FT. 4-WIRE FLAT EXTENSION**

PART # 648235	13.05	G
---------------	-------	---



4-WIRE FLAT VEHICLE/TRAILER SETS

- ◆ **12" TOW VEHICLE END AND 12" TRAILER END SET** Includes 6 splice connectors.

PART # 648165	4.75	G
---------------	------	---
- ◆ **12" TOW VEHICLE END AND 12" TRAILER END SET**

PART # 648175	3.60	G
---------------	------	---
- ◆ **QUICK-FIX™ FLAT** Repairs/replaces damaged 4-wire flat

PART # 648195	7.00	G
---------------	------	---
- ◆ **48" TOW VEHICLE END AND 12" TRAILER END SET** Includes 6 splice connectors.

PART # 648205	5.50	G
---------------	------	---
- ◆ **48" TOW VEHICLE END AND 12" TRAILER END SET**

PART # 648215	5.05	G
---------------	------	---

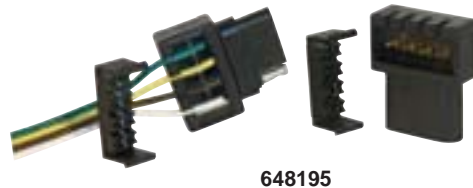

4-WIRE FLAT VEHICLE END

- ◆ **12" TOW VEHICLE END** Includes 3 splice connectors.

PART # 648005	3.25	G
---------------	------	---
- ◆ **12" TOW VEHICLE END**

PART # 648015	2.85	G
---------------	------	---
- ◆ **48" TOW VEHICLE END** Includes 3 splice connectors

PART # 648025	4.20	G
---------------	------	---
- ◆ **ENDURANCE™ 48" TOW VEHICLE END**

PART # 648030	7.35	G
---------------	------	---
- ◆ **48" TOW VEHICLE END**

PART # 648035	3.45	G
---------------	------	---
- ◆ **60" TOW VEHICLE END**

PART # 648045	4.35	G
---------------	------	---
- ◆ **LED 48" TOW VEHICLE END W/L.E.D.** Verify vehicle-side wiring is correct. Integrated "easy-pull" grip.

PART # 648055	7.55	G
---------------	------	---
- ◆ **4-WIRE FLAT TOW VEHICLE END KNOCKOUT CONNECTOR** For use with 1.25" hole diameter or #648605 bracket.

PART # 648065	7.00	G
---------------	------	---
- ◆ **MAG-FLAT™ BRACKET WITH 48" 4-WAY FLAT** Magnetic bracket protects 4-wire flat from harm.

PART # 648085	9.70	G
---------------	------	---
- ◆ **UNIVERSAL KIT** Complete with 3 splices and circuit tester, 48" vehicle end, grease, nylon ties

PART # 646105	12.90	G
---------------	-------	---

4-WIRE FLAT
12" VEHICLE END
PART # 648015 2.85 G



4-WIRE FLAT TRAILER END

- ◆ **12" TRAILER END** Includes 3 splice connectors.

PART # 648105	3.25	G
---------------	------	---
- ◆ **ENDURANCE™ 12" TRAILER END**

PART # 648110	5.05	G
---------------	------	---
- ◆ **48" TRAILER END** Includes 3 splice connectors.

PART # 648125	4.85	G
---------------	------	---
- ◆ **48" TRAILER END**

PART # 648135	4.60	G
---------------	------	---
- ◆ **20 FT. TRAILER Y-HARNESS**

PART # 648245	17.00	G
---------------	-------	---
- ◆ **25 FT. TRAILER Y-HARNESS**

PART # 648255	18.50	G
---------------	-------	---
- ◆ **ENDURANCE™ 20 FT. TRAILER Y-HARNESS W/DUST COVER**

PART # 648240	22.05	G
---------------	-------	---
- ◆ **30 FT. TRAILER Y-HARNESS**

PART # 648265	21.55	G
---------------	-------	---

4-WIRE FLAT
12" TRAILER END
PART # 648115 2.45 G



- tires & wheels
- axles, hubs & springs
- tongue accessories
- hitches
- electrical
- brake parts
- trailer hardware
- locks & pins
- towing & loading
- tie downs
- tools
- chemicals

TRAILER

BASIC WIRING SOLUTIONS • 5-WIRE FLATS



- ◆ 48" VEHICLE END AND 18" TRAILER END Matched set.

PART # 647895 15.25 G

- ◆ 48" VEHICLE END

PART # 647905 9.30 G

- ◆ 18" TRAILER END

PART # 647915 8.10 G



647905

647915

- ◆ 48" **ENDURANCE™** VEHICLE END AND 18" TRAILER END Matched set

PART # 647890 18.95 G

- ◆ 48" **ENDURANCE™** VEHICLE END

PART # 647900 11.90 G

- ◆ 18" **ENDURANCE™** TRAILER END

PART # 647910 9.45 G



647900

647910

4 POLE ROUNDS

4-pole rounds are used in many of the same applications that the 4-wire flat is used. However, 4-pole rounds do not possess an industry standard wiring code.

- ◆ 4 POLE ROUND CONNECTOR KIT Contains matched set plug and socket, mounting bracket, wire, splices and mounting hardware.

PART # 648285 10.90 G

- ◆ TOW VEHICLE END SOCKET

PART # 648305 5.10 G

- ◆ TRAILER END PLUG

PART # 648325 5.10 G

- ◆ MOUNTING BRACKET

PART # 648605 4.40 G

- ◆ 4 POLE MATCHED SET ONLY Socket and plug

PART # 648295 9.10 G



4 POLE MATCHED SET
PART # 648295 9.10 G



648325



648605



648305

5 POLE ROUNDS

5-pole rounds provide one additional function not found in 4-poles. This extra function is typically used for electric brakes, auxiliary or backup function.



- ◆ 5 POLE ROUND CONNECTOR KIT Contains matched set plug and socket, mounting bracket, wire, splices and mounting hardware.

PART # 648345 13.95 G

- ◆ TOW VEHICLE END SOCKET

PART # 648365 5.80 G

- ◆ TRAILER END PLUG

PART # 648385 5.80 G

- ◆ MOUNTING BRACKET

PART # 648605 4.40 G



648385



648605



648365

6 POLE ROUNDS

6-pole rounds provide two additional functions not found in 4-poles. These functions are electric brakes and an auxiliary power lead. The most common use for this type of plug is for horse trailers.

- ◆ 6 POLE ROUND CONNECTOR KIT Contains matched set metal plug and plastic socket, mounting bracket, wire, splices and mounting hardware.

PART # 648405 14.50 G

- ◆ **ENDURANCE™** TOW VEHICLE END SOCKET AND TRAILER END PLUG Includes 648420 and 648440, mounting brackets, terminal grease and mounting hardware

PART # 648400 25.05 G

- ◆ **ENDURANCE™** TOW VEHICLE END SOCKET

PART # 648420 15.10 G

- ◆ TOW VEHICLE END SOCKET Plastic

PART # 648425 6.40 G

- ◆ TOW VEHICLE END SOCKET Metal

PART # 648435 9.95 G

- ◆ **ENDURANCE™** TRAILER END PLUG

PART # 648440 13.30 G

- ◆ TRAILER END PLUG Metal

PART # 648445 5.50 G

- ◆ MOUNTING BRACKET

PART # 648605 4.40 G



648435

648420

648445

648440

648605

648425

HEAVY-DUTY CONNECTORS



1 POLE TRAILER SIDE



PART #
652002 26.25 G

4 POLE VEHICLE SIDE



PART #
652004 8.15 G

4 POLE TRAILER SIDE



PART #
652006 6.45 G

6 POLE MATCHED SET

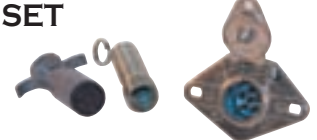

PART #
652007 18.05 G

6 POLE TRAILER SIDE



(With cable protector)

PART #
652008 8.90 G

7-WAY PIN-TYPE VEHICLE SIDE



PART #
652016 15.95 G

7-WAY PIN-TYPE TRAILER SIDE



PART #
652024 15.95 G

7-WAY PIN-TYPE TRAILER SIDE

(With cable protector)



PART #
652027 19.05 G

OTHER CONNECTORS

3 POLE FLAT SET

(12")



PART #
637935 3.15 G

2 POLE IN-LINE SET

(5/16")



PART #
647945 4.00 G

4 POLE IN-LINE SET



PART #
647955 5.30 G

2 POLE FLAT SET

(12")

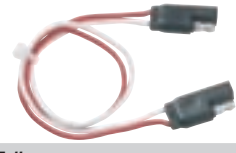

PART #
647965 2.10 G

4 POLE SQUARE SET

(24")

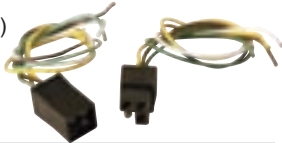

PART #
647975 4.30 G

5 POLE SQUARE SET



(24")

PART #
647985 6.65 G

6 POLE SQUARE SET

(24")

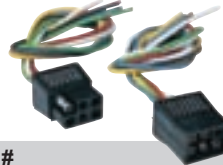

PART #
647995 4.80 G

tires & wheels

axles, hubs & springs

tongue accessories

hitches

electrical

brake parts

trailer hardware

locks & pins

towing & loading

tie downs

tools

chemicals

TRAILER

ACCESSORIES

HOPKINS TRAILER WIRING INSTALLATION KIT - 42 PIECES

- Everything needed to rewire a trailer
- Ideal for Y-harness and 4 conductor wire installation
- Includes specialty tool: 6-12V L.E.D. circuit tester



PART #	MFG #		
651000	51020	11.55	G

HOPKINS TOWING DELUXE ELECTRICAL ACCESSORIES KIT - 100 PIECES

- Everything needed for installation, maintenance and repair of vehicle and trailer wiring
- Ideal for all basic wiring, Y-harness, T-connector and 4 conductor wire installation
- Includes specialty tools: multi-purpose wire tool, terminal cleaner, grit sandpaper cloth and 6-12V L.E.D. circuit tester



PART #	MFG #		
651020	51020	22.55	G

TOW-READY UNIVERSAL BATTERY CONNECTORS



PART #	MFG #	DESCRIPTION		
444304	118630	Side Post, 1-3/4" Short Side Terminal	11.95	B
444305	118631	Side Post, 1-3/16" Long Side Terminal	11.95	B
444306	118634	Tap/Ground Kit, Side Mount With 22-16 Gauge Terminals	11.95	B



FUSES & FUSE HOLDERS



444310



PART #	MFG #	DESCRIPTION		
444310	38654	40 amp. Maxi-Fuse®	1.95	B



444307



444308

PART #	MFG #	DESCRIPTION		
444307	18099-025	In-line Fuse Holder wire taps (self-stripping) for use w/32v maximum - 20 amp maximum bayonet type fuses & 14 to 18 gauge wire (25 pack)	59.95	B

BONDED WIRE



◆ 14 GAUGE

4-wire bonded (25 feet)

PART # 649905 30.65 G

◆ 16 / 18 GAUGE

4-wire bonded (25 feet)

PART # 649915 20.90 G

◆ 16 / 18 GAUGE

4-wire bonded (100 feet spool)

PART # 649955 56.10 G

◆ 12 GAUGE

2-wire bonded (Black/blue, 100 feet spool)

PART # 649975 50.10 G





TAILLIGHT CONVERTERS

WHICH CONVERTER DO I NEED?



POWER TAILLIGHT CONVERTER

These units completely isolate the tow vehicle from trailer malfunctions. Power is taken directly from the battery for isolation and brighter trailer headlights. Each unit can power up to 2 sets of stop/turn signals (8.0 amps) on the trailer.

SHORT-PROOF POWER TAILLIGHT CONVERTER

Protects tow vehicle electronics and itself from wiring shorts. Self-resetting.

PART #	MFG #		
646365	46365	89.05	G



Short circuit protected. Can power up to 8.0 amps per output.

POWER TAILLIGHT CONVERTER

Solid state electronics. For vehicles equipped with independent bulb turn signals and brake lights or common bulb systems.

PART #	MFG #		
646255	46365	72.70	G



Short circuit protected. Can power up to 5.0 amps per output.

NEGATIVE INPUT SHORT-PROOF POWER TAILLIGHT CONVERTER

Protects tow vehicle electronics and itself from wiring shorts. Self-resetting.

PART #	MFG #		
646345	46345	89.05	G



Short circuit protected. Can power up to 8.0 amps per output.

ELECTRONIC TAILLIGHT CONVERTER

Electronic taillight converters adapt an independent bulb taillight system of the tow vehicle to the common bulb taillight system of the trailer. Each unit can power 2.1 amps per stop/turn signal.

UNIVERSAL KIT

Complete with splices and circuit tester.



PART #	MFG #		
646155	46155	33.50	G

TAILLIGHT CONVERTER

Recommended for repairing a damaged taillight converter.



PART #	MFG #		
648845	48845	13.10	G

TAILLIGHT CONVERTER

Double-molded weatherproof design.



PART #	MFG #		
648915	48915	19.55	G

HEAVY DUTY TAILLIGHT CONVERTER

Double-molded weatherproof design. Converter mounts in trunk out of harm's way.



PART #	MFG #		
648925	48925	25.05	G

VEHICLE TOWING VEHICLE TAILLIGHT ISOLATING KIT

Permanently installs on towed vehicle near taillights.



PART #	MFG #		
648955	48955	28.30	G

tires & wheels

axles, hubs & springs

tongue accessories

hitches

electrical

brake parts

trailer hardware

locks & pins

towing & loading

tie downs

tools

chemicals

TRAILER



VEHICLE WIRING KITS

NO CUTTING! NO SPLICING! SAVES TIME!

Unplug your vehicle's factory wiring harness and plug in a Hopkins® vehicle wiring kit. That's how easy trailer wiring is with a Plug-In-Simple® wiring kit, featuring OEM connectors for a perfect, weather-tight fit!

These kits provide a 4-wire flat connector for your trailer. Optional "pre-wired" 4-wire flat to 6 pole round and 4-wire flat to 7 RV blade round extension adapters are available to custom install the vehicle side wiring to most trailer configurations.

MULTI-TOW® PLUG-IN SIMPLE!® T-CONNECTORS

TOYOTA/LEXUS MULTI-TOW® MULTI-TOW® 7:4

Tundra	2003-07
Sequoia	2006-08
4-Runner	2004-09
GX470	2004-09

- Provides 7 RV blade and 4-wire flat towing!
- Fits standard 7 RV blade bracket

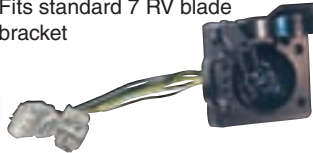

PART #	MFG #		
643385	43385	37.60	G

TOYOTA MULTI-TOW® MULTI-TOW® 7:4

(non-retail packaging)

- Provides 7 RV blade and 4-wire flat towing!
- Fits standard 7 RV blade bracket



Tundra	2008-10
--------	---------

PART #	MFG #		
643395	11143395	37.60	G

TOYOTA Sequoia (w/factory 2003-2004 - 7 way)

- Plug-In Simple!® Wiring Kit: No cutting, No splicing- Saves time
- Includes dust cover, cable ties and grease packet



PART #	MFG #		
620421	11143384	38.95	G

TOYOTA MULTI-TOW® MULTI-TOW® 7:4

- Plug-In Simple!® Wiring Kit: No cutting, No splicing- Saves time
- Utilizes OEM connectors- enhanced fit and weatherproofing



PART #	MFG #		
620420	11143325	38.95	G

Multi-Tow® Connectors give you the ability to tow trailers with different wiring connectors from the same vehicle connector. These connectors simply replace the 7-way connector that came with your vehicle.

MULTI-TOW® 7:4 DODGE/CHRYSLER/JEEP/MERCEDES/MITSUBISHI

- Multi-Tow® provides multiple towing options from one connector
- Plug-In Simple!®: No cutting, No splicing- Saves time
- Utilizes OEM connectors- enhanced fit and weatherproofing
- Applies to over 10 different vehicle applications equipped with a factory tow package
- Impact and corrosion resistant
- Includes dust cover and mounting bracket



PART #	MFG #		
642145	42145	35.80	G

MULTI-TOW® 7:4 FORD/CHEVY/GMC

- Multi-Tow® provides multiple towing options from one connector
- Provides sockets for towing both 7 RV Blade and 4 Wire Flat trailers
- Plug-In Simple!®: No cutting, No splicing- Saves time
- Utilizes OEM connectors create an exact fit and maximum weatherproofing
- Applies to over 30 different vehicle applications equipped with a factory tow package
- Impact and corrosion resistant
- Includes dust cover and mounting bracket



PART #	MFG #		
640955	40955	35.80	G

MULTI-TOW® 6:4 FORD/CHEVY/GMC

- Multi-Tow® provides 6 Pole Round and 4 Wire Flat towing options from one connector
- Plug-In Simple!®: No cutting, No splicing- Saves time
- Utilizes OEM connectors- enhanced fit and weatherproofing
- Applies to over 30 different vehicle applications equipped with a factory tow package
- Impact and corrosion resistant- Includes dust cover and mounting bracket



PART #	MFG #		
640965	40965	35.80	G

MULTI-TOW® 7:4 FORD/CHEVY/GMC (OEM REPLACEMENT)

- Multi-Tow® provides 7 RV Blade and 4 Wire Flat towing options from one connector
- Plug-In Simple!®: No cutting, No splicing- Saves time
- Utilizes OEM connectors- enhanced fit and weatherproofing
- Applies to over 30 different vehicle applications equipped with a factory tow package
- Impact and corrosion resistant
- 2-Door connector protection
- Includes unique snap-fit bracket



PART #	MFG #		
640975	40975	41.10	G

UNIVERSAL MULTI-TOW® HARNESS

- For use with 640955, 640965, 640975
- Used to retro-fit GM trucks between 1999-2002 to allow use of the GM OE plug connector. Plugs directly into the above Multi-Tow applications.
- Splices onto vehicles' wiring system.
- Allows for Multi-Tow® installation on any vehicle.

PART #	MFG #		
640985	40985	26.85	G



SEE APPLICATION ON FOLLOWING 2 PAGES

- tires & wheels
- axles, hubs & springs
- tongue accessories
- hitches
- electrical
- brake parts
- trailer hardware
- locks & pins
- towing & loading
- tie downs
- tools
- chemicals

MULTI-TOW® PLUG-IN-SIMPLE!® T-CONNECTORS

ENDURANCE™ TWIST-MOUNT 7 BLADE

The Endurance™ Twist-Mount 7 Blade Connector is compatible with GM tow vehicles from 2000 to the current year. Incorporating Endurance design features enables this connector to last for years of trouble-free use.

- Exact O.E.M. Fit
- Plug-In Simple!® for quick and easy installation or replacement



PART #	MFG #		
620412	40930	14.95	G

ENDURANCE™

FORD / CHEVY / GMC (OEM REPLACEMENT)

- Compatible with Ford, GM and other popular tow vehicles
- Plug-In Simple!® for quick and easy installation or replacement
- Durable lid opens 180 degrees
- Ultimate weatherproofing



PART #	MFG #		
620415	40940	14.95	G

ENDURANCE™ DODGE/CHRYSLER/JEEP OEM QUICK-INSTALL™ WIRING KIT

- Allows for Dodge trucks to adapt to the Quick-Install™ 7 RV Blade
- Reinforced lid opens 180 degrees to prevent breaking
- Ultimate weatherproofing



PART #	MFG #		
620416	42190	33.95	G

MODEL	YEAR	PART #
AUDI		
Q3 (w/ tow pkg)	09-15	620415, 640955, 640965, 640975
Q5 (w/ tow pkg)	09-14	620415, 640955, 640965, 640975
Q7 (w/ tow pkg)	07-15	620415, 640955, 640965, 640975
BUICK		
Enclave (w/ tow pkg)	08-15	620412, 620415, 640955, 640965, 640975
Rainier	04-07	620412, 620415, 640955, 640965, 640975
CADILLAC		
Escalade	02-15	620412, 620415, 640955, 640965, 640975
CHEVROLET		
Avalanche	02-13	620412, 620415, 640955, 640965, 640975
Colorado (w/ tow pkg)	15	620412, 620415, 640955, 640965, 640975
Colorado (w/ tow pkg)	08-12	620412, 620415, 640955, 640965, 640975
Express Van (w/ tow pkg)	03-15	620412, 620415, 640955, 640965, 640975
Silverado 1500	03-13	620412, 620415, 640955, 640965, 640975
Silverado 1500, 2500, 3500	14-15	620412, 620415, 640955, 640965, 640975
Silverado 2500/3500 (New body style)	99-13	620412, 620415, 640955, 640965, 640975
Suburban	00-15	620412, 620415, 640955, 640965, 640975
Tahoe	00-15	620412, 620415, 640955, 640965, 640975
Trailblazer	02-09	620412, 620415, 640955, 640965, 640975
Traverse (w/ tow pkg)	10-15	620412, 620415, 640955, 640965, 640975
CHRYSLER		
Aspen (w/ tow pkg)	07-09	620415, 640955, 640965, 640975
Aspen (w/ tow pkg)	Early 07	642145, 620416
Pacifica (w/ tow pkg)	03-08	642145, 620416

MODEL	YEAR	PART #
DODGE		
Dakota (w/ tow pkg)	00-10	642145, 620416
Durango (w/ tow pkg)	07-15	620415, 640955, 640965, 640975
Durango (w/ tow pkg) (Early 07)	00-07	642145, 620416
Journey (w/ tow pkg)	09-10	620415, 640955, 640965, 640975
Nitro (w/ tow pkg)	07-09	620415, 640955, 640965, 640975
Ram 1500 (w/ tow pkg)	00-09	642145, 620416
Ram 1500 (w/ tow pkg) see also Ram	10-15	620415, 640955, 640965, 640975
Ram Pickup 2500/3500 (w/ tow pkg)	00-09	642145, 620416
Ram Pickup 2500/3500 (w/ tow pkg) see also Ram	10-15	620415, 640955, 640965, 640975
Ram Promaster (w/ tow pkg) see also Ram	14-15	620415, 640955, 640965, 640975
Ram Van	01-03	642145, 620416
Sprinter (w / tow pkg)	04-08	642145, 620416
Sprinter 2500	09	642145, 620416
Sprinter 3500	09	642145, 620416
FORD		
Econoline Van (w/ factory 7 blade)	04-14	620415, 640955, 640965, 640975
Escape (w/ tow pkg)	13-15	620415, 640955, 640965, 640975
Excursion	00-05	620415, 640955, 640965, 640975
Expedition (w/ factory 7 blade)	99-14	620415, 640955, 640965, 640975
Explorer (w/ factory 7 blade)	02-15	620415, 640955, 640965, 640975
Explorer Sport Trac (w/ tow pkg)	07-10	620415, 640955, 640965, 640975
F-150 (w/ tow pkg)	08-15	620415, 640955, 640965, 640975
F-250, 350 (w/ tow pkg)	08-15	620415, 640955, 640965, 640975
Transit T-150 Van (w/ tow)	15	620415, 640955, 640965, 640975
Transit T-250 Wagon (w/ tow)	15	620415, 640955, 640965, 640975
Transit T-350 Wagon XLT (w/ tow)	15	620415, 640955, 640965, 640975

tires & wheels

axles, hubs & springs

tongue accessories

hitches

electrical

brake parts

trailer hardware

locks & pins

towing & loading

tie downs

tools

chemicals

TRAILER

MULTI-TOW® PLUG-IN-SIMPLE!® T-CONNECTORS

- tires & wheels
- axles, hubs & springs
- tongue accessories
- hitches
- electrical
- brake parts
- trailer hardware
- locks & pins
- towing & loading
- tie downs
- tools
- chemicals

TRAILER

MODEL	YEAR	PART #
GMC		
Acadia (w/ tow pkg)	07-15	620412, 620415, 640955, 640965, 640975
Canyon (w/ tow pkg)	15	620412, 620415, 640955, 640965, 640975
Canyon (w/ tow pkg)	08-12	620412, 620415, 640955, 640965, 640975
Denali	01-14	620412, 620415, 640955, 640965, 640975
Envoy (w/ tow pkg)	02-09	620412, 620415, 640955, 640965, 640975
Savana Van (full size) (w/ tow pkg)	09-15	620412, 620415, 640955, 640965, 640975
Sierra 1500	99-13	620412, 620415, 640955, 640965, 640975
Sierra 1500, 2500, 3500	14-15	620412, 620415, 640955, 640965, 640975
Sierra 2500/3500	03-13	620412, 620415, 640955, 640965, 640975
Yukon	00-15	620412, 620415, 640955, 640965, 640975
HUMMER		
H2	03-09	620412, 620415, 640955, 640965, 640975
H3	06-09	620412, 620415, 640955, 640965, 640975
INFINITI		
QX56 (w/ tow pkg), QX80	04-15	620415, 640955, 640965, 640975
ISUZU		
Ascender	04-08	620412, 620415, 640955, 640965, 640975
JEEP		
Cherokee (w/ tow pkg)	14-15	620415, 640955, 640965, 640975
Commander (w/ tow pkg)	06-10	642145, 620416
Grand Cherokee (w/ tow pkg)	00-04	642145, 620416
Grand Cherokee (w/ tow pkg)	07-10	642145, 620416
Grand Cherokee (w/ tow pkg)	11-15	620415, 640955, 640965, 640975
Grand Cherokee (w/ tow pkg) (Early 07)	05-07	642145, 620416
Liberty (w/ tow pkg)	04-07	642145, 620416
Liberty (w/ tow pkg)	08-10	620415, 640955, 640965, 640975
Wrangler / Renegade (w/ tow pkg)	04-06	642145, 620416
Wrangler / Renegade (w/ tow pkg)	07-15	642145, 620416
KIA		
Borrego (w/ tow pkg.)	09	620415, 640955, 640965, 640975
LAND ROVER		
LR4 (w/ tow pkg)	13-14	620415, 640955, 640965, 640975
Range Rover (w/ tow pkg)	13-14	620415, 640955, 640965, 640975

MODEL	YEAR	PART #
LINCOLN		
Aviator (w/ factory 7 blade)	03-06	620415, 640955, 640965, 640975
Mark LT	06-08	620415, 640955, 640965, 640975
MKT (w/ tow pkg)	09	620415, 640955, 640965, 640975
MKT (w/ tow pkg)	10-14	620415, 640955, 640965, 640975
Navigator (w/ tow pkg)	99-15	620415, 640955, 640965, 640975
MERCEDES BENZ		
GL Class (w/ tow pkg)	07-10	642145, 620416
M Class (w/ tow pkg)	98-14	620415, 640955, 640965, 640975
MERCURY		
Mountaineer (w/ factory 7 blade)	02-10	620415, 640955, 640965, 640975
MITSUBISHI		
Raider (w/ tow pkg)	06-08	642145, 620416
NISSAN		
Armada	04-15	620415, 640955, 640965, 640975
Pathfinder (w/ tow pkg)	13-15	620415, 640955, 640965, 640975
Titan	04-15	620415, 640955, 640965, 640975
OLDSMOBILE		
Bravada	02-04	620412, 620415, 640955, 640965, 640975
PORSCHE		
Cayenne (w/ tow pkg.)	13-14	620415, 640955, 640965, 640975
RAM		
Ram 1500 (w/ tow pkg)	10-15	620415, 640955, 640965, 640975
Ram Pickup 2500/3500 (w/ tow pkg)	10-15	620415, 640955, 640965, 640975
Ram Promaster (w/ tow pkg)	14-15	620415, 640955, 640965, 640975
Ram Tradesman Van (w/ tow pkg)	14-15	642145, 620416
SAAB		
9-7X	05-10	620412, 620415, 640955, 640965, 640975
SATURN		
Outlook (w/ tow pkg)	07-10	620415, 640955, 640965, 640975
TOYOTA		
Sequoia (w/ tow pkg)	10-14	620415, 640955, 640965, 640975
Tundra (w/ factory 7 blade)	14-15	620415, 640955, 640965, 640975
VOLKSWAGEN		
Touareg (w/ tow pkg)	12-15	620415, 640955, 640965, 640975

4-WIRE FLAT MULTI-TOW® PLUG-IN-SIMPLE!® T-CONNECTORS



641125



641155



643355



643575



642205



642105



643855



643915

APPLICATION	YEAR	PART #		
AUDI				
Q3 (w/ tow pkg)	09-15	641155	20.50	G
Q5 (w/ tow pkg)	09-14	641155	20.50	G
Q7 (w/ tow pkg)	07-15	641155	20.50	G
BUICK				
Enclave (w/ tow pkg)	08-15	641155	20.50	G
Rainier	04-07	641155	20.50	G
Rendezvous	02-07	641405	20.50	G
CADILLAC				
Escalade	02-15	641155	20.50	G
Escalade	99-00	641125	20.50	G
CHEVROLET				
Avalanche	02-13	641155	20.50	G
Blazer (full size)	92-94	641125	20.50	G
Colorado	04-12	641165	38.65	G
Colorado (w/ tow pkg)	08-12	641155	20.50	G
Colorado (w/ tow pkg)	15	641155	20.50	G
Express Van (w/ tow pkg)	03-15	641155	20.50	G
Pickup (full size)	88-98	641125	20.50	G
Pickup C/K (Old body style)	99-00	641125	20.50	G
Silverado 1500	03-13	641155	20.50	G
Silverado 1500 (New Body)	99-02	641145	33.70	G
Silverado 1500, 2500, 3500	14-15	641155	20.50	G
Silverado 2500/3500 (New body style)	99-13	641155	20.50	G
Suburban	92-99	641125	20.50	G
Suburban	00-15	641155	20.50	G
Tahoe	95-99	641125	20.50	G
Tahoe	00-15	641155	20.50	G
Trailblazer	02-09	641155	20.50	G
Traverse (w/ tow pkg)	10-15	641155	20.50	G
CHRYSLER				
Aspen	07-09	642245	57.05	G
Aspen (w/ tow pkg)	07-09	641155	20.50	G
Town & Country	91-95	642205	35.75	G
Town & Country	04-07	642235	36.30	G
DODGE				
Caravan / Grand Caravan	91-95	642205	35.75	G
Caravan / Grand Caravan	04-07	642235	36.30	G
Dakota	04-11	642205	35.75	G
Durango	04-09	642245	57.05	G
Durango (w/ tow pkg)	07-15	641155	20.50	G
Journey (w/ tow pkg)	09-10	641155	20.50	G
Nitro (w/ tow pkg)	07-09	641155	20.50	G
Ram 1500 (w/ tow pkg) see also Ram	10-15	641155	20.50	G

APPLICATION	YEAR	PART #		
DODGE CONTINUED				
Ram Pickup 1500	02-06	642135	57.05	G
Ram Pickup 1500	07-09	642205	35.75	G
Ram Pickup 2500/3500	03-06	642135	57.05	G
Ram Pickup 2500/3500	07-09	642205	35.75	G
Ram Pickup 2500/3500 (w/ tow pkg) see also Ram	10-15	641155	20.50	G
Ram Promaster (w/ tow pkg) see also Ram	14-15	641155	20.50	G
FORD				
Econoline Van (w/ factory 7 blade)	04-14	641155	20.50	G
Escape (w/ tow pkg)	01-04	640445	15.55	G
Escape (w/ tow pkg)	05-07	640455	15.55	G
Escape (w/ tow pkg)	13-15	641155	20.50	G
Excursion	00-05	641155	20.50	G
Expedition (w/ factory 7 blade)	99-14	641155	20.50	G
Explorer	06-10	640345	18.20	G
Explorer (w/ factory 4 flat)	02-05	640335	18.20	G
Explorer (w/ factory 7 blade)	02-15	641155	20.50	G
Explorer Sport Trac (w/ tow pkg)	07-10	641155	20.50	G
F-150	05-08	640185	29.55	G
F-150 (w/ tow pkg)	08-15	641155	20.50	G
F-250 Heavy Duty, F-350	02-04	640165	18.20	G
F-250 Heavy Duty, F-350	05-07	640195	29.55	G
F-250, 350 (w/ tow pkg)	08-15	641155	20.50	G
Flex (w/ tow pkg)	09-15	641155	20.50	G
Transit T-150 Van (w/ tow)	15	641155	20.50	G
Transit T-250 Wagon (w/ tow)	15	641155	20.50	G
Transit T-350 Wagon XLT (w/ tow)	15	641155	20.50	G
GMC				
Acadia (w/ tow pkg)	07-15	641155	20.50	G
Canyon	04-07	641165	38.65	G
Canyon (w/ tow pkg)	08-12	641155	20.50	G
Canyon (w/ tow pkg)	15	641155	20.50	G
Canyon (w/o tow pkg)	08-12	641165	38.65	G
Denali	99-00	641125	20.50	G
Denali	01-14	641155	20.50	G
Envoy (w/ tow pkg)	02-09	641155	20.50	G
Jimmy (full size)	92-94	641125	20.50	G
Pickup (Classic) (Old body style)	99-00	641125	20.50	G
Savana Van (full size) (w/ tow pkg)	09-15	641155	20.50	G
Sierra 1500	03-13	641155	20.50	G
Sierra 1500 (New body style)	99-02	641155	20.50	G
Sierra 1500 (New body style)	99-02	641145	33.70	G
Sierra 1500, 2500, 3500	14-15	641155	20.50	G
Sierra 2500/3500	03-13	641155	20.50	G
Yukon	92-99	641125	20.50	G
Yukon	00-15	641155	20.50	G

- tires & wheels
- axles, hubs & springs
- tongue accessories
- hitches
- electrical
- brake parts
- trailer hardware
- locks & pins
- towing & loading
- tie downs
- tools
- chemicals

TRAILER

4-WIRE FLAT MULTI-TOW® PLUG-IN-SIMPLE!® T-CONNECTORS

tires & wheels
axles, hubs & springs
tongue accessories
hitches
electrical
brake parts
trailer hardware
locks & pins
towing & loading
tie downs
tools
chemicals

TRAILER

APPLICATION	YEAR	PART #	
HONDA			
Ridgeline	06-14	643125	51.30 G
HUMMER			
H2	03-09	641155	20.50 G
H3	06-09	641155	20.50 G
HYUNDAI			
Santa Fe	01-06	643805	46.45 G
Tucson	05-09	643815	51.30 G
INFINITI			
QX56 (w/ tow pkg), QX80	04-15	641155	20.50 G
ISUZU			
Ascender	04-08	641155	20.50 G
I-280	06	641165	38.65 G
I-290	07-08	641165	38.65 G
I-350	06	641165	38.65 G
I-370	07-08	641165	38.65 G
JEEP			
Cherokee (w/ tow pkg)	14-15	641155	20.50 G
Commander	06-10	642705	84.70 G
Grand Cherokee (Early 07)	05-07	642545	77.00 G
Grand Cherokee (w/ tow pkg)	11-15	641155	20.50 G
Liberty	02-07	642475	55.30 G
Liberty (w/ tow pkg)	08-10	641155	20.50 G
Wrangler	07-15	642635	28.40 G
Wrangler / Renegade	98-04	642615	28.40 G
Wrangler / Renegade	05-06	642625	28.40 G
KIA			
Borrego (w/ tow pkg.)	09	641155	20.50 G
Sportage	05-06	643925	51.30 G
LAND ROVER			
LR4 (w/ tow pkg)	13-14	641155	20.50 G
Range Rover (w/ tow pkg)	13-14	641155	20.50 G
LINCOLN			
Aviator (w/ factory 4 flat)	03-05	640335	18.20 G
Aviator (w/ factory 7 blade)	03-06	641155	20.50 G
Mark LT	06-08	641155	20.50 G
MKT (w/ tow pkg)	09-14	641155	20.50 G
Navigator (w/ tow pkg)	99-15	641155	20.50 G
MAZDA			
Tribute (w/ tow pkg)	01-06	640445	15.55 G
MERCEDES BENZ			
M Class (w/ tow pkg)	98-14	641155	20.50 G
MERCURY			
Mariner (w/ tow pkg)	05-07	640455	15.55 G
Mountaineer (w/ factory 4 flat)	02-05	640335	18.20 G
Mountaineer (w/ factory 7 blade)	02-10	641155	20.50 G
MITSUBISHI			
Raider	06-08	642205	35.75 G

APPLICATION	YEAR	PART #	
NISSAN			
Armada	04-15	641155	20.50 G
Frontier Pickup	98-04	643515	51.45 G
Frontier Pickup (w/ tow pkg)	05-11	643575	15.55 G
Pathfinder (w/ tow pkg)	13-15	641155	20.50 G
Pathfinder (w/ tow pkg)	05-09	643575	15.55 G
Titan	04-15	641155	20.50 G
Xterra	00-04	643595	15.55 G
Xterra	05-08	643605	75.85 G
Xterra (w/ factory 4 flat)	05-15	643575	15.55 G
OLDSMOBILE			
Bravada	02-04	641155	20.50 G
PLYMOUTH			
Voyager / Grand Voyager	91-95	642205	35.75 G
PONTIAC			
Aztek	01-05	641405	20.50 G
PORSCHE			
Cayenne (w/ tow pkg.)	13-14	641155	20.50 G
RAM			
Ram 1500 (w/ tow pkg)	10-15	641155	20.50 G
Ram Pickup 2500/3500 (w/ tow pkg)	10-15	641155	20.50 G
Ram Promaster (w/ tow pkg)	14-15	641155	20.50 G
SAAB			
9-7X	05-10	641155	20.50 G
SATURN			
Outlook (w/ tow pkg)	07-10	641155	20.50 G
SUBARU			
B9 Tribeca	06-14	643855	92.35 G
Forester	98-08	643855	92.35 G
Impreza (Sedan)	02-07	643855	92.35 G
Legacy	03-08	643855	92.35 G
Outback	96-08	643855	92.35 G
SUZUKI			
Equator (w/ factory 4 flat)	09-12	643575	15.55 G
TOYOTA			
Pickup (except T-100)	84-95	643315	45.95 G
Sequoia (w/ tow pkg)	10-13	641155	20.50 G
Sequoia (w/ tow pkg)	14	641155	20.50 G
Sequoia (w/ tow pkg) (MT)	05-09	620420	38.95 G
Sequoia (w/ tow pkg) (MT)	03-04	620421	38.95 G
T-100	93-98	643355	67.45 G
Tacoma	95-04	643315	45.95 G
Tacoma (w/o tow pkg)	05-15	643355	67.45 G
Tundra (w/ factory 7 blade)	07-13	643395	37.60 G
Tundra (w/ tow pkg)	03-06	643385	37.60 G
Tundra (w/ factory 7 blade)	14-15	641155	20.50 G
VOLKSWAGEN			
Touareg (w/ tow pkg)	12-15	641155	20.50 G



HASSLE-FREE HOOKUPS!

EASILY ALIGN BALL TO TRAILER EVERY TIME



SMART HITCH™ CAMERA AND SENSOR SYSTEM

- Allows for one person to hitch by themselves
- No Splicing! Plugs in behind tow package connector
- Large, 3.5" color monitor with static free image
- Camera with SmartZone™ sensors

PART # 620414 198.95 G

FITS VEHICLE	YEAR
CADILLAC	
ESCALADE / EXT / ESV	02-15
CHEVROLET	
AVALANCHE	02-13
COLORADO (W/ TOW PKG)	08-12, 15
SILVERADO 1500/2500/3500	03-07, 14-15
SILVERADO 1500 (NEW BODY)	07-13
SILVERADO 2500/3500 (NEW BODY STYLE)	99-02, 07-13
SUBURBAN	00-15
TAHOE	00-15
DODGE	
RAM 1500/2500/3500 (W/ TOW PKG) SEE ALSO RAM	10-15
FORD	
EXCURSION	00-05
EXPEDITION (W/ FACTORY 7 BLADE)	99-15
EXPLORER SPORT TRAC (W/ TOW PKG)	07-10
F-150, 250, 350 (W/ TOW PKG)	08-15
FLEX (W/ TOW PKG)	09-14

FITS VEHICLE	YEAR
GMC	
CANYON (W/ TOW PKG)	08-12, 15
DENALI	01-14
SIERRA 1500/2500/3500	03-07, 14-15
SIERRA 1500 (NEW BODY STYLE)	99-02, 07-13
SIERRA 2500/3500 (NEW BODY STYLE)	07-13
SAVANA VAN (FULL SIZE) (W/ TOW PKG)	09-15
YUKON	00-15
LINCOLN	
AVIATOR (W/ FACTORY 7 BLADE)	03-06
MARK LT	06-08
NAVIGATOR (W/ TOW PKG)	99-15
NISSAN	
ARMADA	04-15
TITAN	04-15
RAM	
RAM 1500/2500/3500 (W/ TOW PKG)	10-15
TOYOTA	
TUNDRA (W/ FACTORY 7 BLADE)	14-15



tires & wheels

axles, hubs & springs

tongue accessories

hitches

electrical

brake parts

trailer hardware

locks & pins

towing & loading

tie downs

tools

chemicals

TRAILER

VEHICLE AND TRAILER WIRING CODES

IMPORTANT - Identify the wires on your vehicle and trailer by function only. Color coding is not standard among all manufacturers. Illustrations represent the rear views of the connectors

- tires & wheels
- axles, hubs & springs
- tongue accessories
- hitches
- electrical
- brake parts
- trailer hardware
- locks & pins
- towing & loading
- tie downs
- tools
- chemicals

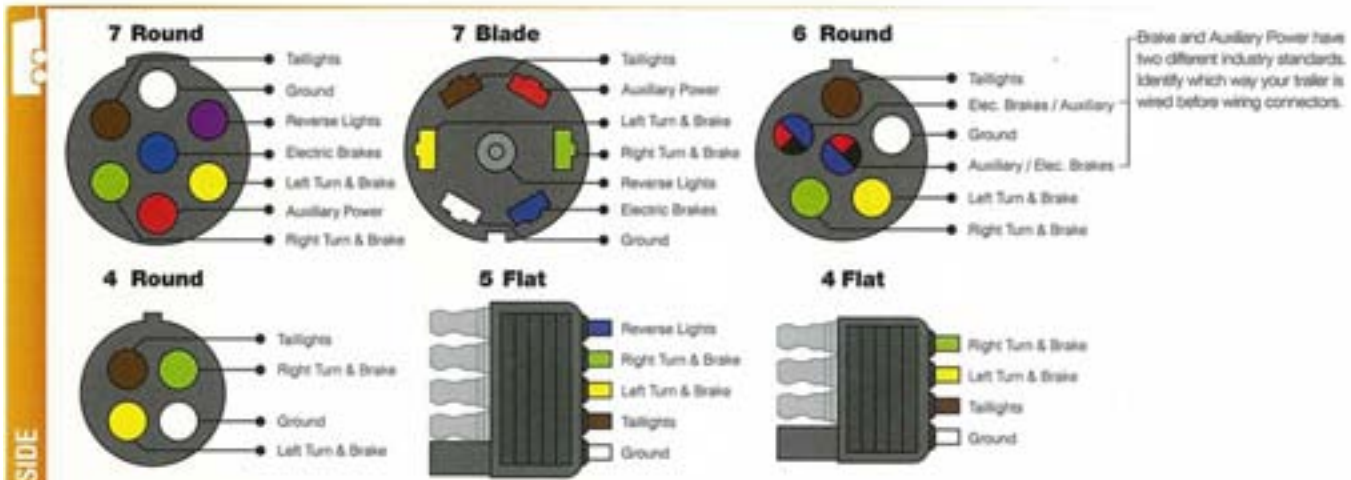
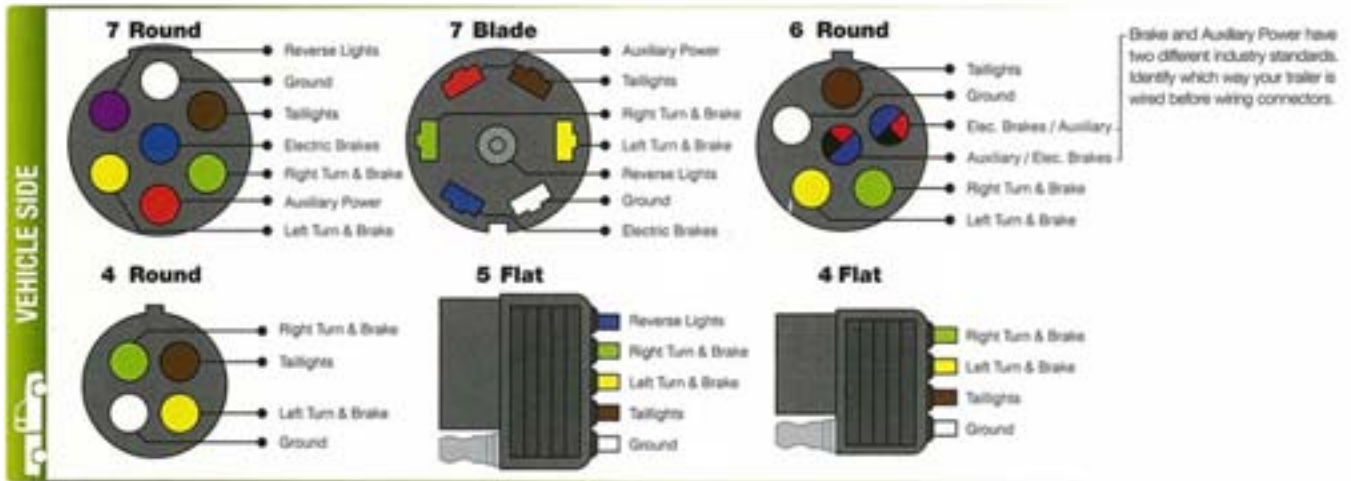

HOPKINS® MODEL NO. 48240, 48245, 48255, 48265 TRAILER WIRING DIAGRAM

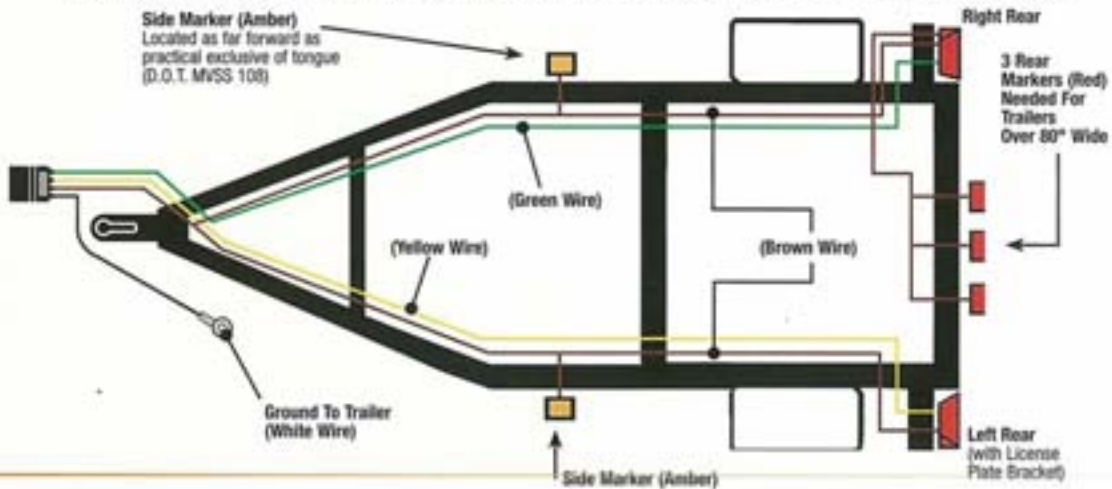

TRAILER



ELECTRICAL CONNECTORS



- Offer the widest coverage of 'T' connectors in the industry, which covers over 500 vehicle applications
- No cutting, splicing or taping
- Solid one piece construction
- 16 gauge bonded wire with 4-flat plug
- Simple do-it-yourself instructions on every package
- It's quick and easy - just plug in the 'T' one connector and you are ready to tow

MAKE/MODEL	YEAR	PART #			
CHEVROLET/GMC					
Lumina APV Van	93-96	DT18337	12.50	AD	
FORD					
Aerostar Van	96 & earlier	DT18251	17.50	AD	
MERCURY					
Monterey	04-07	DT18385*	19.50	AD	
* Equipped with ModuLite trailer light power module					
Sable (Sedan Only)	92-95	DT18351	17.50	AD	

MAKE/MODEL	YEAR	PART #			
MITSHUBISHI					
Outlander	03-06	DT18306	15.50	AD	
LEXUS					
LX470	01-07	DT18245	9.50	AD	
LX570	08	DT18245	9.50	AD	
RX300	01-03	DT18245	9.50	AD	
OLDSMOBILE					
Silhouette Van	93-96	DT18337	12.50	AD	
PONTIAC					
Trans Sport Van	93-96	DT18337	12.50	AD	
All Models (inc. Montana)	94-98	DT18337	12.50	AD	
TOYOTA					
HighLander	01-03	DT18245	9.50	AD	
4-Runner	01-02	DT18245	9.50	AD	
Land Cruiser	01-02	DT18245	9.50	AD	

- tires & wheels
- axles, hubs & springs
- tongue accessories
- hitches
- electrical**
- brake parts
- trailer hardware
- locks & pins
- towing & loading
- tie downs
- tools
- chemicals



REPLACEMENT FACTORY TOW PACKAGE WIRING HARNESSES



- Exact replacement for damaged OEM wiring harnesses
- Installs in seconds on vehicles not factory pre-wired
- Upgrades vehicles from 4-flat OEM wiring to 7-way connectors
- Connects directly to standard OEM connector
- Attractive point-of-purchase packaging

PART #				
DT18241	4-Flat 1998-01 Ford Explorer w/OEM Tow Package 1998-99 Ford Ranger Pickup w/OEM Tow Package 1998-01 Mazda B-Series Pickups w/ OEM Tow Package	9.50	AD	
DT20028	6-Way 1997-03 Ford F-150& F-250 LD Pickups (Upgrades from OEM 4-Flat to 6-Way Wiring) 2004 F-150 Heritage (old body style)	19.50	AD	

PART #				
DT20029	6-Way 1999-01 Ford F-250 & F-350 Superduty Pickups (Upgrades from OEM 4-Flat to 6-Way Wiring)	19.50	AD	
DT18245	4-Flat 2001-04 Lexus LX470 2001-03 Lexus RX300 2001-02 Toyota 4-Runner	9.50	AD	

TAILLIGHT CONVERTERS



- Adapts import and domestic vehicles with separate turn and stop lights (3-wire system) to standard trailer taillight wiring (2-wire system)
- Taillight converter (aluminum housing) w/12" hook-up leads and 48" 4-flat car end connector

PART #	MFG #			
DT18028	18028	17.50	AD	

TRAILER

12V AUXILIARY POWER SOURCES

The following items provide a dependable source of power for electrical accessories using a standard adapter plug. For spotlights, tire pumps, GPS, cell phones etc. Can be installed on any 12V system such as snowmobiles, ATVs, tractors, boats, vehicles, motor homes etc.

CIGARETTE LIGHTER WITH MAP LIGHT

- 30" extension with combination lighter/map light
- Easy... Handy...
- Plugs into lighter socket
- Comes with hang clip



PART #	MFG #		
EM44420	86-44420	14.95	L

CIGARETTE LIGHTER

- Moisture-resistant lighter designed for all weather use in an open space
- Clamp-on design fits almost anywhere



PART #	MFG #		
EM44410	86-44410	16.95	L

EXTENSION POWER CORD

- With on/off switch
- Can take up to 12 amp and 150 watts of current



PART #	MFG #		
621201	SM-01201	9.95	L

DUAL POWER OUTLET

The perfect solution when you want to plug in several items at one time.



PART #	MFG #		
621202	SM-01202	9.95	L

12-VOLT 3-WAY OUTLET

- 12-volt DC accessory plug
- Built-in 10 amp fuse protects against overload
- Useful for multiple 12-volt accessories: cell phone charger, GPS, laptop, strobe light



PART #	MFG #		
BY5601	5601203	6.45	G



POWER OUTLET

- 12 Volt power outlet
- Requires 12 volt battery source
- Fits all Ski-Doo models plus others
- Replaces Ski-Doo #861-5072-00



PART #	MFG #		
571085	SM-01085	13.95	L

7-WAY TO CIGARETTE ADAPTER

- Provides 12v power at rear of vehicle for travel accessories
- Ideal for power inverter hook-up
- Great for tailgating



PART #	MFG #		
444336	118019	15.75	B

UNIVERSAL DC CONNECTOR

- With dash adapter
- Will fit your electric shields, handlebar grip heater, hot socks, phone bags, etc.
- RCA standard



PART #	MFG #		
621601	01-601	6.95	L

12-VOLT DC PLUG IN WITH STANDARD RCA JACK FOR HEATED VISORS



PART #	MFG #		
621200	SM-01200	7.95	L

9 FOOT POWER OUTLET

- Clips to any 12 volt battery
- Perfect to plug in spotlights, cell phones, etc.
- 3 foot cord and 15 amp safety fuse
- Plastic



PART #	MFG #		
621203	SM-01203	6.95	L

12-VOLT DUAL OUTLET

- 12-volt twin power receptacle with 15-amp, 150-watt safety fuse
- Clamshell packaged



PART #	MFG #		
OP1202	A1202	9.90	G



- tires & wheels
- axles, hubs & springs
- tongue accessories
- hitches
- electrical
- brake parts
- trailer hardware
- locks & pins
- towing & loading
- tie downs
- tools
- chemicals



BRAKE PARTS

- tires & wheels
- axles, hubs & springs
- tongue accessories
- hitches
- electrical
- brake parts
- trailer hardware
- locks & pins
- towing & loading
- tie downs
- tools
- chemicals

BRAKE CONTROL INFORMATION

CROSS-REFERENCE BRAKE CONTROL WIRING GUIDE

WIRE FUNCTIONS		12 VOLTS	STOPLIGHT	GROUND	TRAILER BRAKES	ILLUMINATION				
BRAKE CONTROL WIRE COLOR		BLACK	RED	WHITE	BLUE	NOT USED				
MAKE	MODEL - YEAR	VEHICLE OEM WIRE COLOR								
CHEVY / GMC	2007 (New Body Style) - 2013	RED	LIGHT BLUE	WHITE	WHITE	DARK BLUE	BROWN			
CHEVY / GMC	1999 - 2007 (Classic Body Style)	RED	LIGHT BLUE		BLACK	DARK BLUE	BROWN			
DODGE	2009-2012	RED	YELLOW	WHITE	VIOLET	BLACK	DRK GREEN	DARK GREEN		
DODGE	2003-2008	RED	WHITE	BLUE	WHITE	BLACK	GREEN	BLUE		
DODGE	1997-2002	RED		WHITE		BLACK		BLUE		
FORD	F-250 / 350 2009-2013	RED	BROWN	BLUE	ORANGE	BLACK	GRAY	BLUE		
FORD	F-150 2009-2013	RED	RED GRAY	GREEN	YEL GRN	WHITE	BROWN	BLUE		
FORD	F-150 1994-2008	RED		LIGHT GREEN		WHITE		DARK BLUE	BROWN	
TOYOTA / LEXUS	2003-2012	BLACK		GREEN	YELLOW	BLACK	WHITE	BLUE	RED	GREEN

BE SAFE, BE LEGAL!

If your gross trailer weight exceeds the limit, a braking system is required.*

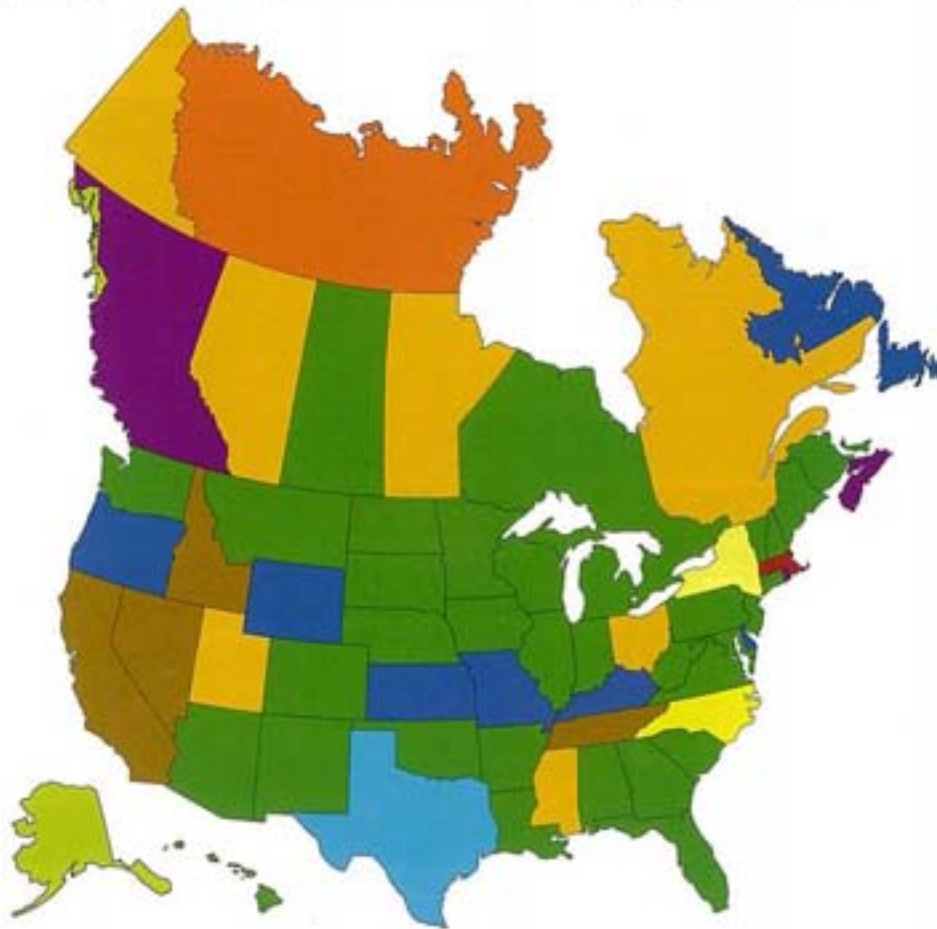

GROSS TRAILER WEIGHT REQUIREMENT FOR BRAKE CONTROLS

- 0 lb limit
- 1,000 lb (455 kg) limit
- 1,500 lb (682 kg) limit
- 2,000 lb (910 kg) limit
- 3,000 lb (1360 kg) limit
- 4,000 lb (1800 kg) limit
- 4,500 lb (2045 kg) limit
- 5,000 lb (2273 kg) limit
- 10,000 lb (4545 kg) limit
- Special requirements

*Contact your department of transportation for complete towing law information



INDUSTRY LEADING TRAILER BRAKE CONTROLS

P3® TAKING INNOVATION TO A WHOLE NEW LEVEL

After receiving valuable insight from industry experts and our own customers, Tekonsha® did something truly amazing: We listened and responded. The result is the P3; the industry's most advanced trailer electric brake control. A true proportional braking system, P3 has several added features, making it the new standard for electric trailer brake controls.

- A distinct, easy-to-read LCD display with multiple screen color options
- "Up-Front" controls provide easy access to all P3 features
- Easy to understand diagnostics show output current, battery/brake/output voltage
- A "flashing red" warning system alerts user to "No Trailer Brake" situations
- Select Electric over Hydraulic or Electric trailer brake mode
- Screen information display in English, French or Spanish
- "The Original Boost" feature allows for different levels of customized braking
- Compact, dash-hugging design
- Unique, easy-to-use, clip-mounting system
- Quick disconnect feature for easy storage
- Electric trailer brake control for up to 4 braking axles
- Limited lifetime warranty (some conditions apply)
- Display boxed - complete as shown



8590195 195.16 B



ACCESSORIES FOR P3®

PART #			DESCRIPTION
855904	2.96	B	Dash Mounting Clip Bracket
852178	4.80	E	Mounting Bracket Kit
857894	15.09	E	3 Ft. Pigtail Harness Kit
855901	5.04	B	T-Slot Bracket

PRODIGY® P2 ADVANCED INTELLIGENCE

- Reverse battery protection for both vehicle and breakaway
- Designed to work with electric over hydraulic brake systems
- Numerous mounting options – including 360 degree vertical rotation
- Digital display depicts voltage delivery to trailer during braking
- No level adjustment necessary – adjusts to varying terrain as you drive
- Great for backing into tough spots! Works proportionally in reverse - with the ability to disable when not needed
- Produces stops that are in proportion to vehicle's deceleration rate
- "Boost" feature gives users the ability to apply more initial trailer braking power when towing heavier trailers
- Continual diagnostics check for proper connection, shorted magnet conditions and much more
- Quick and easy disconnect feature allows user to remove and store the control when not in use
- Electric trailer brake control for up to 4 braking axles
- Limited lifetime warranty (some conditions apply)
- Display boxed - complete as shown



890885 167.24 B



ACCESSORIES FOR PRODIGY® P2

PART #			DESCRIPTION
857686	10.35	E	Dash Pocket Mounting Kit
857685	6.23	E	Mounting Bracket
857894	15.09	E	3 Ft. Pigtail Harness Kit

7-WAY TRAILER EMULATOR

7-Way Trailer Emulator is used for the proper installation and set-up of a brake control when a trailer is not readily available. Brake control set-up is accomplished using a built-in load module that will stimulate electric magnet brakes on a trailer. (The emulator will also check electrical continuity of all circuits in the 7-way blade style connector.)



856560 46.57 E

- tires & wheels
- axles, hubs & springs
- tongue accessories
- hitches
- electrical
- brake parts**
- trailer hardware
- locks & pins
- towing & loading
- tie downs
- tools
- chemicals

TRAILER



PRODIGY® RF ELECTRONIC BRAKE CONTROL FOR 1 TO 3 AXLE TRAILERS, TRAILER MOUNTED, PROPORTIONAL

Utilize for rental businesses, fleet ownerships or multiple tow vehicles. Requires no leveling.

Remote Hand Held Unit

- No under dash wiring necessary – utilizes wireless communication
- The original "Boost" feature allows for different levels of customized braking
- System runs continual diagnostics and displays fault codes in hand held unit's display
- Plugs into standard 12-volt power accessory adaptor
- 5 year limited warranty

Trailer Mount (Power Module) Unit

- Utilizes standard sealed 8' blade style 7-way connector
- Multiple mounting positions on tongue or front of trailer
- 15 year limited warranty on power module
- 1 year limited warranty on cord

If you take to the road with multiple vehicles, there's really only one solution: PRODIGY® RF. Consider all it offers:

- User does not need a dash mounted, hard wired brake control
- True proportional trailer braking, forward or reverse
- No level adjustment necessary
- Trailer braking power supplied via 7-Way Connector from the vehicle
- Suitable for use on any trailer with up to 3 braking axles

In the Tow Vehicle (Hand Held unit):

- Wireless communication between the remote hand unit and trailer mounted power module eliminates the need for under dash wiring
- Easy to see LED display for trailer brake voltage, power output and diagnostics
- Easy to use remote hand control; includes the Prodigy® "Boost" system to allow for different levels of customized braking
- Unit provides continual diagnostic scanning with a visual warning display
- Hand held unit plugs into any standard 12 volt power accessory adaptor
- Hand held unit has a 5-year limited warranty

On the Trailer (Power Module Unit):

- Power module uses standard RV Blade style (Bargman) 7-Way truck and trailer connectors
- Trailer Power Module is watertight and is powered through 7-way cable from the tow vehicle.
- Multiple mounting options on the tongue or front of the trailer
- Trailer mounted power module has a 15-year limited warranty (1-year limited warranty on cord)



444192 412.41 B



REPLACEMENT PART FOR PRODIGY® RF HAND HELD REMOTE

444193 136.18 B

- tires & wheels
- axles, hubs & springs
- tongue accessories
- hitches
- electrical
- brake parts
- trailer hardware
- locks & pins
- towing & loading
- tie downs
- tools
- chemicals

TRAILER



INDUSTRY LEADING TRAILER BRAKE CONTROLS

PRIMUS™ IQ THE SMARTER BRAKING SOLUTION

Primus IQ is a totally proportional electric trailer brake control. This easy-to-set system allows the driver maximum flexibility when determining how the trailer should respond to a braking event. Snap-in dash mounting clip and removable electrical connector allow the unit to be quickly stored (or moved to another vehicle) when not in use.

- Works proportionally in reverse
- No level adjustment necessary, adjusts to varying terrain as you drive
- Digital display shows voltage to trailer during braking
- "The Original Boost" feature allows for customized braking
- Pre-assembled wire harness for simple hook-up and quick disconnect
- Diagnostic features incorporated in LED display
- Electric trailer brake control for up to 3 braking axles
- Limited lifetime warranty (some conditions apply)
- Display boxed - complete as shown



890160 107.90 B



856927



855280

ACCESSORIES FOR PRIMUS™ IQ

PART #	DESCRIPTION		
856927	5.17	E	Dash Mounting Kit

VOYAGER®

The Voyager incorporates Tekonsha's patented braking sensor and is the best value you'll find for smooth and secure trailer braking. It's compact size and features, like a bicolored LED brake monitor (to assure a complete connection to trailer brakes and give an indication of relative braking power being applied) make the Voyager extremely versatile. Voyager minimizes interference with tow vehicle electrical systems, uses a four wire hook up, has a broad setting range and is compatible with most any vehicle.

- Broad control range makes setting quick and easy
- As braking power is applied, the LED changes color gradually from green (completed circuit) to red, to indicate relative braking power
- Advanced electronics minimize false braking for smoother ride
- Electric trailer brake control for up to 4 braking axles
- 5-year limited warranty
- Display boxed - complete as shown



859030 89.81 B

852178



ACCESSORIES FOR VOYAGER®

PART #	DESCRIPTION		
852178	4.80	E	Mounting Kit

REPLACEMENT WIRING HARNESS

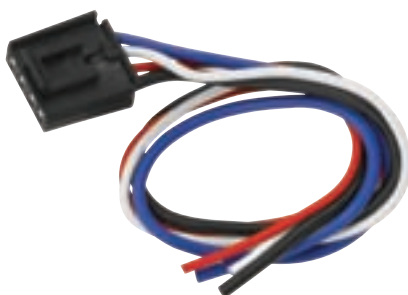

PART #	DESCRIPTION		
444203 EACH	5.99	B	P3 90195, P2 90885, Primus IQ 90160, I-Stop IQ 20191, 5520 Activator III, 83520 Brakeman Ultra
444204 12 PACK	51.77	B	P3 90195, P2 90885, Primus IQ 90160, I-Stop IQ 20191, 5520 Activator III, 83520 Brakeman Ultra

- tires & wheels
- axles, hubs & springs
- tongue accessories
- hitches
- electrical
- brake parts
- trailer hardware
- locks & pins
- towing & loading
- tie downs
- tools
- chemicals

TRAILER

BRAKE PARTS

Reese's timed brake controls are great choices for your basic economical light-duty towing needs. These time actuated controls have solid state electronics and can be mounted in any position - horizontal, vertical, even turned upside down.

- tires & wheels
- axles, hubs & springs
- tongue accessories
- hitches
- electrical
- brake parts
- trailer hardware
- locks & pins
- towing & loading
- tie downs
- tools
- chemicals

TRAILER

REESE BRAKEMAN® DIGITAL

- 1 to 4 axle trailers Digital output indicator
- Thumb wheel output adjustment
- "Up- front" manual over-ride control
- Overload indicator
- Mounting hardware included Smooth and simple installation
- Lifetime limited warranty

444046 130.10 B



REESE BRAKEMAN® COMPACT

- 1 to 2 axle trailers Illuminated LED output indicator
- Slide adjustment output control
- "Up- front" manual over-ride control
- Mounting hardware included
- Smooth and simple installation
- 3 year limited warranty

444047 83.22 B



REESE BRAKEMAN® IV

- 1 to 4 axle trailers
- Digital output indicator
- Small, compact design
- Up-front push buttons for Sync and Output
- Diagnostics for Overload, Open Ground
- Short Circuit Protected
- Mounts in any direction
- No leveling required
- Mounting hardware included
- Smooth and simple installation
- Plug & Play feature allows quick and easy connection
- Attractive point-of-purchase display packaging
- Lifetime limited warranty

444194 123.90 B

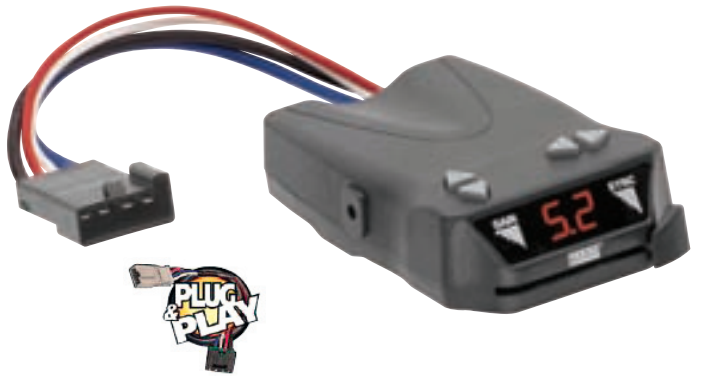

REESE BRAKEMAN® ULTRA

- 1 to 4 axle trailers
- Overload indicator
- Digital output indicator
- "Up-front" manual over-ride control
- Soft touch thumb wheels
- Front display allows viewing at almost any angle
- Stylish upgraded appearance
- Mounts in any position
- No leveling required
- Mounting hardware included
- Integrated Plug & Play port for 2-plug adapters
- Limited Lifetime Warranty

444195 140.44 B





I-STOP™ IQ BRAKE CONTROL

A totally proportional electric trailer brake control, the new Draw-Tite I-Stop™IQ is self-leveling so no level adjustment is necessary.

Utilizing the primary sensor technology from Draw-Tite I-Stop™Ultra, the Draw-Tite I-Stop™IQ now includes the "Boost" feature that gives users the ability to apply more initial trailer braking when towing heavier trailers. It works proportionally in reverse for backing into tough spots and includes a snap-in dash mounting clip and removable electrical connector that allows the unit to be quickly stored when not in use. You will appreciate the digital readout depicting a secure electrical connection, amount of voltage delivery to the trailer brakes and diagnostic features incorporated in the LED display.

- Utilizes "Plug-N-Play" port for 2-plug adapters
- Self-diagnostics features will illuminate LED readout when issues occur
- Includes a "Boost" feature
- Works proportionally in reverse
- Snap-in dash mounting clip and hardware included
- Digital LED readout
- Snap-in mounting clip allows user to remove and store the control when not in use
- Limited lifetime warranty



444196 107.90 B



ACTIVATOR® IV BRAKE CONTROL

- 1 to 4 axle trailers
- Digital output indicator
- Small, compact design
- Up-front push buttons for Sync and Output
- Diagnostics for Overload, Open Ground
- Short Circuit Protected
- Mounts in any direction
- No leveling required
- Mounting hardware included
- Smooth and simple installation
- Plug & Play feature allows quick and easy connection
- Attractive point-of-purchase display packaging
- Lifetime limited warranty



444197 123.90 B



ACTIVATOR® III BRAKE CONTROL

- 1 to 4 axle trailers
- Digital output indicator
- Soft touch thumb wheels
- "Up- front" manual over-ride control
- Overload indicator
- "Plug-N-Play" port
- Front display allows viewing at almost any angle
- Mounts in any position
- Mounting hardware included
- Smooth and simple installation
- Stylish upgraded appearance
- No leveling required
- Lifetime limited warranty



444198 140.44 B

tires & wheels

axles, hubs & springs

tongue accessories

hitches

electrical

brake parts

trailer hardware

locks & pins

towing & loading

tie downs

tools

chemicals

TRAILER

- tires & wheels
- axles, hubs & springs
- tongue accessories
- hitches
- electrical
- brake parts**
- trailer hardware
- locks & pins
- towing & loading
- tie downs
- tools
- chemicals

TRAILER



ACTIVATOR® II BRAKE CONTROL

- 1 to 4 axle trailers
- Digital output indicator
- Thumb wheel output adjustment
- "Up- front" manual over-ride control
- Overload indicator
- Mounting hardware included
- Smooth and simple installation
- Plug & Play feature allows quick and easy connection
- Attractive point-of-purchase display packaging
- Lifetime limited warranty



444199 130.10 B



ACTIVATOR® BRAKE CONTROL

- 1 to 2 axle trailers
- Illuminated LED output indicator
- Slide adjustment output control
- "Up- front" manual over-ride control
- Mounting hardware included
- Smooth and simple installation Plug & Play feature allows quick and easy connection
- Attractive point-of-purchase display packaging
- 5 year limited warranty



444200 83.22 B



PILOT® BRAKE CONTROL

Pilot has a dark, smoke lens that is ideal for direct light applications, creating optimum visibility to read the large, two-digit display. Pilot has flexible mounting options and can be installed in any direction. Our microprocessor allows you the ability to read the display even when mounted upside down. The Pilot's digital display shows voltage output to the brakes.

- Large easy to read dual digital display shows:
- Properly wired control
- Voltage output to brakes (vs. a percentage)
- Connection to trailer
- Dark smoke lens ideal for direct light applications; performs better than red lens
- Protection against short circuit/loss of ground
- Microprocessor allows control to be mounted upside down and still have a readable display
- Standard mounting bracket included with optional ball mount available
- For use on any 12 volt negative ground system
- Plug & Play feature allows quick and easy connection
- Limited lifetime warranty



444201 96.55 B

TEKONSHA REESE BRAKE CONTROL WIRING HARNESSES



All vehicle specific brake control wiring harnesses are available in 2-Plug styles and are clamshell packaged. 2-Plug units are designed for brake controls that have a wiring port built into the back of the unit. Simply plug the brake control end of the wiring harness into the back of the brake control and the vehicle end into the automobile's port. Brake controls that utilize the 2-plug style of wiring harness will be identified with the Plug & Play logo.



MODEL	YEAR	POS	PART#		
BUICK					
Enclave w/Factory 7-Way	08-12	BP1	853026	18.52	E
CADILLAC					
Escalade	02	BP1	853025	15.28	E
Escalade	03-06	BP1	853015	15.04	E
Escalade ESV	03-06	BP1	853015	15.04	E
Escalade EXT	02	BP1	853025	15.28	E
Escalade EXT	03-06	BP1	853015	15.04	E
CHEVROLET					
Avalanche 1500	02	BP1	853025	15.28	E
Avalanche 1500	03-06	BP1	853015	15.04	E
Avalanche 2500	02	BP1	853025	15.28	E
Avalanche 2500	03-06	BP1	853015	15.04	E
Pickup, Silverado 1500 HD	01-02	BP1	853025	15.28	E
Pickup, Silverado 1500 HD	03-06	BP1	853015	15.04	E
Pickup, Silverado 1500 HD Classic Only	07	BP1	853015	15.04	E
Pickup, Silverado 1500 LD	99-02	BP1	853025	15.28	E
Pickup, Silverado 1500 LD	03-06	BP1	853015	15.04	E
Pickup, Silverado 1500 LD 5.8 ft. Bed, 2 & 4 WD (New Body Style)	14	BP2	444206	18.52	B
Pickup, Silverado 1500 LD 6.6 ft. Bed, 2 & 4 WD (New Body Style)	14	BP2	444206	18.52	B
Pickup, Silverado 1500 LD Classic Only	07	BP1	853015	15.04	E
Pickup, Silverado 2500 HD	01-02	BP1	853025	15.28	E
Pickup, Silverado 2500 HD	03-06	BP1	853015	15.04	E

MODEL	YEAR	POS	PART#		
CHEVROLET CONTINUED					
Pickup, Silverado 2500 HD Classic Only	07	BP1	853015	15.04	E
Pickup, Silverado 2500 LD	99-02	BP1	853025	15.28	E
Pickup, Silverado 2500 LD	03-04	BP1	853015	15.04	E
Pickup, Silverado 3500 Series	01-02	BP1	853025	15.28	E
Pickup, Silverado 3500 Series	03-06	BP1	853015	15.04	E
Pickup, Silverado 3500 Series Classic Only	07	BP1	853015	15.04	E
Suburban 1500	03-06	BP1	853015	15.04	E
Suburban 1500 New Body Style w/Amber Turn Signals	00-02	BP1	853025	15.28	E
Suburban 2500	03-06	BP1	853015	15.04	E
Suburban 2500 New Body Style w/Amber Turn Signals	00-02	BP1	853025	15.28	E
Tahoe	03-06	BP1	853015	15.04	E
Tahoe New Body Style w/Amber Turn Signals	00-02	BP1	853025	15.28	E
Traverse w/Factory 7-Way	09-14	BP1	853026	18.52	E
CHRYSLER					
Aspen w/Factory Tow Package	07-09	BP2	853020	15.61	E
DODGE					
Dakota Pickup w/Factory Tow Package (See RAM for 2011 Models)	97-10	BP2	853020	15.61	E
Durango w/Factory Tow Package	98-09	BP2	853020	15.61	E
Durango w/Factory Tow Package	11-14	BP2	444207	18.52	B
Pickup, Ram, Full Size 1500 Only, All Models	95-09	BP2	853020	15.61	E

- tires & wheels
- axles, hubs & springs
- tongue accessories
- hitches
- electrical
- brake parts
- trailer hardware
- locks & pins
- towing & loading
- tie downs
- tools
- chemicals

TRAILER

BRAKE PARTS

BRAKE CONTROL WIRING HARNESSES CONTINUED

tires & wheels
axles, hubs & springs
tongue accessories
hitches
electrical
brake parts
trailer hardware
locks & pins
towing & loading
tie downs
tools
chemicals

TRAILER

MODEL	YEAR	POS	PART#		
DODGE CONTINUED					
Pickup, Ram, Full Size 1500 Only, All Models (See RAM for 2011& Newer Models)	10	BP1	853021	15.17	E
Pickup, Ram, Full Size 2500 HD Only, All Models (See RAM for 2011& Newer Models)	10	BP1	853021	15.17	E
Pickup, Ram, Full Size 2500 Only, All Models	95-09	BP2	853020	15.61	E
Pickup, Ram, Full Size 3500 HD Only, All Models (See RAM for 2011& Newer Models)	10	BP1	853021	15.17	E
Pickup, Ram, Full Size 3500 Only, All Models	95-09	BP2	853020	15.61	E
FORD					
Bronco Full Size	94-96	BP3	853035	12.85	E
E-150 Econoline Van Full Size, All Models	92-08	BP3	853035	12.85	E
E-150 Econoline Van Full Size, All Models	09-14	BP7	853034	15.09	E
E-250 Econoline Van Full Size, All Models	92-08	BP3	853035	12.85	E
E-250 Econoline Van Full Size, All Models	09-14	BP7	853034	15.09	E
E-350 Econoline Van Full Size, All Models	92-08	BP3	853035	12.85	E
E-350 Econoline Van Full Size, All Models	09-14	BP7	853034	15.09	E
E-350 Econoline Van RV Cutaway w/Factory Tow Prep Plug	92-08	BP3	853035	12.85	E
E-350 Econoline Van RV Cutaway w/Factory Tow Prep Plug	09-11	BP7	853034	15.09	E
E-450 Econoline Van RV Cutaway w/Factory Tow Prep Plug	92-08	BP3	853035	12.85	E
E-450 Econoline Van RV Cutaway w/Factory Tow Prep Plug	09-11	BP7	853034	15.09	E
Excursion	00-05	BP3	853035	12.85	E
Expedition	97-12	BP3	853035	12.85	E
Expedition	13-14	BP5	853034	15.09	E
Explorer w/Factory Tow Package	02-05	BP6	853035	12.85	E
Explorer w/Factory Tow Package	06-10	BP2	853035	12.85	E
Explorer w/Factory Tow Package	11-14	BP2	853035	12.85	E
Explorer Sport Trac w/Factory Tow Package	07-10	BP2	853035	12.85	E
F-150	94-96	BP3	853035	12.85	E
F-150 Flareside (New Body Style)	04-08	BP3	853035	12.85	E
F-150 Flareside (New Body Style)	09-14	BP3	853036	12.64	E
F-150 Styleside (New Body Style)	04-08	BP3	853035	12.85	E

MODEL	YEAR	POS	PART#		
FORD CONTINUED					
F-150 Styleside (New Body Style)	09-14	BP3	853036	12.64	E
F-150 Light Duty Flareside	97-03	BP3	853035	12.85	E
F-150 Light Duty Styleside	97-03	BP3	853035	12.85	E
F-150 Light Duty Heritage Flareside Old Body Style	04	BP3	853035	12.85	E
F-150 Light Duty Heritage Styleside Old Body Style	04	BP3	853035	12.85	E
F-150 SuperCrew	00-03	BP3	853035	12.85	E
F-150 SuperCrew New Body Style	04-08	BP3	853035	12.85	E
F-150 SuperCrew New Body Style, w/5.5 & 6.5 ft. Beds	09-14	BP3	853036	12.64	E
F-250	94-96	BP3	853035	12.85	E
F-250 Heavy Duty	97	BP3	853035	12.85	E
F-250 Light Duty Styleside	97-99	BP3	853035	12.85	E
F-250 Super Duty	99-04	BP3	853035	12.85	E
F-250 Super Duty	05-07	BP5	853065	13.89	E
F-250 Super Duty	08-14	BP3	853034	15.09	E
F-350	94-96	BP3	853035	12.85	E
F-350 Heavy Duty	97	BP3	853035	12.85	E
F-350 Super Duty	99-04	BP3	853035	12.85	E
F-350 Super Duty	05-07	BP5	853065	13.89	E
F-350 Super Duty	08-14	BP3	853034	15.09	E
F-350 Super Duty Cab & Chassis	05-07	BP5	853065	13.89	E
F-350 Super Duty Cab & Chassis	08-12	BP3	853034	15.09	E
F-450 Super Duty	08-14	BP3	853034	15.09	E
F-450 Super Duty Cab & Chassis	99-04	BP3	853035	12.85	E
F-450 Super Duty Cab & Chassis	05-07	BP5	853065	13.89	E
F-450 Super Duty Cab & Chassis	08-12	BP3	853034	15.09	E
F-550 Super Duty Cab & Chassis	99-04	BP3	853035	12.85	E
F-550 Super Duty Cab & Chassis	05-07	BP5	853065	13.89	E
F-550 Super Duty Cab & Chassis	08-12	BP3	853034	15.09	E
Flex w/Factory Tow Package	09-11	BP2	853035	12.85	E
Flex w/Factory Tow Package	12-13	BP3	853036	12.64	E
Windstar w/Factory Tow Package	95-03	BP3	853035	12.85	E
GMC					
Acadia w/Factory 7-Way	07-14	BP1	853026	18.52	E
Pickup, Sierra 1500 HD	01-02	BP1	853025	15.28	E
Pickup, Sierra 1500 HD	03-06	BP1	853015	15.04	E
Pickup, Sierra 1500 HD Classic Only	07	BP1	853015	15.04	E

BRAKE CONTROL WIRING HARNESSES CONTINUED

MODEL	YEAR	POS	PART#		
GMC CONTINUED					
Pickup, Sierra 1500 LD	99-02	BP1	853025	15.28	E
Pickup, Sierra 1500 LD	03-06	BP1	853015	15.04	E
Pickup, Sierra 1500 LD 5.8 ft. Bed, 2 & 4 WD (New Body Style)	14	BP2	444206	18.52	B
Pickup, Sierra 1500 LD 6.6 ft. Bed, 2 & 4 WD (New Body Style)	14	BP2	444206	18.52	B
Pickup, Sierra 1500 LD Classic Only	07	BP1	853015	15.04	E
Pickup, Sierra 2500 HD	01-02	BP1	853025	15.28	E
Pickup, Sierra 2500 HD	03-06	BP1	853015	15.04	E
Pickup, Sierra 2500 HD Classic Only	07	BP1	853015	15.04	E
Pickup, Sierra 2500 LD	99-02	BP1	853025	15.28	E
Pickup, Sierra 2500 LD	03-04	BP1	853015	15.04	E
Pickup, Sierra 3500 Series	01-02	BP1	853025	15.28	E
Pickup, Sierra 3500 Series	03-06	BP1	853015	15.04	E
Pickup, Sierra 3500 Series Classic Only	07	BP1	853015	15.04	E
Yukon	03-06	BP1	853015	15.04	E
Yukon New Body Style w/Amber Turn Signals	00-02	BP1	853025	15.28	E
Yukon Denali	03-06	BP1	853015	15.04	E
Yukon Denali New Body Style w/Amber Turn Signals	01-02	BP1	853025	15.28	E
Yukon XL 1500	00-02	BP1	853025	15.28	E
Yukon XL 1500	03-06	BP1	853015	15.04	E
Yukon XL 2500	00-02	BP1	853025	15.28	E
Yukon XL 2500	03-06	BP1	853015	15.04	E
Yukon XL Denali	01-02	BP1	853025	15.28	E
Yukon XL Denali	03-06	BP1	853015	15.04	E
HONDA					
Pilot w/Factory Tow Package	09-14	BP1	853070	11.56	E
Ridgeline w/Factory Tow Package	06-14	BP1	853070	11.56	E
HUMMER					
H2	03-07	BP1	853015	15.04	E
H2 SUT	05-07	BP1	853015	15.04	E
INFINITI					
QX56	04-14	BP1	853050	15.43	E
JEEP					
Grand Cherokee w/Factory Tow Package	11-14	BP2	444207	18.52	B
KIA					
Borrego	09-11	BP4	444208	13.44	B
LAND ROVER					
LR3	05-09	BP3	853035	12.85	E
LR4	10-11	BP3	853035	12.85	E
Range Rover Inc. Sport	05-13	BP3	853035	12.85	E
Range Rover Evoque	12	BP2	853035	12.85	E

MODEL	YEAR	POS	PART#		
LEXUS					
GX 460	10-13	BP4	853040	16.98	E
GX 470	03-09	BP3	853040	16.98	E
LX 470	03-07	BP3	853040	16.98	E
LX 570	08-11	BP3	853040	16.98	E
LX 570	13	BP4	853040	16.98	E
LINCOLN					
Aviator w/Factory Tow Package	03-05	BP6	853035	12.85	E
Mark LT	06-08	BP3	853035	12.85	E
MKT w/Factory Tow Package	10-11	BP1	853035	12.85	E
MKT w/Factory Tow Package	12	BP1	853036	12.64	E
Navigator	98-12	BP3	853035	12.85	E
Navigator	13-14	BP3	853034	15.09	E
MERCURY					
Mountaineer w/Factory Tow Package	02-05	BP6	853035	12.85	E
Mountaineer w/Factory Tow Package	06-10	BP2	853035	12.85	E
NISSAN					
Armada	04-14	BP1	853050	15.43	E
Frontier Pickup	05-14	BP3	853050	15.43	E
Pathfinder	05-14	BP3	853050	15.43	E
Titan Pickup	04-14	BP1	853050	15.43	E
Xterra w/Factory Tow Package	05-14	BP3	853050	15.43	E
RAM					
1500 All Models	11-12	BP1	853021	15.17	E
1500 All Models	13-14	BP3	853023	27.86	E
		BP9	444209	97.53	B
		BP8	444210	109.72	B
2500 HD All Models	11-12	BP1	853021	15.17	E
2500 HD All Models	13-14	BP3	853023	27.86	E
		BP8	444210	109.72	B
		BP9	444209	97.53	B
3500 HD All Models	11-12	BP1	853021	15.17	E
3500 HD All Models	13-14	BP3	853023	27.86	E
		BP9	444209	97.53	B
		BP8	444210	109.72	B
Dakota Pickup w/Factory Tow Package	11	BP2	853020	15.61	E
SATURN					
Outlook w/Factory 7-Way	07-09	BP1	853026	18.52	E
TOYOTA					
4Runner	03-14	BP4	853040	16.98	E
LandCruiser	03-11	BP3	853040	16.98	E
LandCruiser	13-14	BP3	853040	16.98	E
Sequoia	03-14	BP4	853040	16.98	E
Tacoma Pickup	07-14	BP4	853040	16.98	E
Tundra	03-14	BP4	853040	16.98	E

tires & wheels
axles, hubs & springs
tongue accessories
hitches
electrical
brake parts
trailer hardware
locks & pins
towing & loading
tie downs
tools
chemicals

TRAILER

- tires & wheels
- axles, hubs & springs
- tongue accessories
- hitches
- electrical
- brake parts**
- trailer hardware
- locks & pins
- towing & loading
- tie downs
- tools
- chemicals

- BP1** - Under or behind dash, to the left or right of the emergency brake pedal.
- BP2** - Under or behind dash to the left of the steering column and brake pedal.
- BP3** - Under or behind dash to the right of the steering column and brake pedal.
- BP4** - Kick panel area, on the Driver's side.
- BP5** - Under or behind dash, behind the center console.
- BP6** - Under or behind dash on the passenger side, near glovebox.
- BP7** - Centered behind dash between the steering column and the radio.
- BP8** - Under or behind dash to the right of the steering column and brake pedal. Also includes 7-Way adapter kit located at the rear center behind the bumper. This unit complies with all applicable California Regulations.
- BP9** - Includes 7-Way adapter kit located at the rear center behind the bumper. This unit complies with all applicable California Regulations.

VEHICLE SPECIFIC BRAKE CONTROL WIRING HARNESS POSITION



BRAKE MATE™ KIT

Includes all necessary parts required to completely install all brake controls. No other parts are necessary. Each BRAKE MATE™ KIT includes:

- Pre-wired 7-way round connector
- Heavy-Duty flasher
- Scotch locks (5 pcs.)
- Self tapping screws (8 pcs.)
- 4-Flat trailer end
- Heavy-Duty breakers (2 pcs.)
- Ring connectors (7 pcs.)
- Tie straps (6 pcs.)

118607 95.57 E



For simple mounting, choose 7-Way Mounting Box. Part Numbers **DT18156**, **DT18157** or **DT18159** (sold separately). Clamshell packaged.

BRAKE CONTROL INSTALL KITS (WITHOUT 6/7-WAY CONNECTORS)

PART #		DESCRIPTION	• Clamshell packaged
820505	47.26	E	Wiring kit for 1-2 axle brake control systems, includes 25' 12-2 duplex wire, 20 amp circuit breaker and attaching terminals
820506	55.44	E	Wiring kit for 3-4 axle brake control systems, includes 25' 10-2 duplex wire, 30 amp circuit breaker and attaching terminals



PULSE PREVENTOR

Immunizes against the effects of 4-Way flashers on some brake controls.

444205 24.27 B





TRAILER ELECTRIC BREAKAWAY SYSTEMS & ACCESSORIES

For use on 1, 2, 3, and 4 axle trailers equipped with electric brakes. These complete systems incorporate the highest quality components in trailer breakaway systems. Meet or exceed Department of Transportation (DOT) specifications regarding trailer breakaway and holding requirements. If a breakaway occurs between your tow vehicle and your trailer, the breakaway systems will automatically apply consistent braking power to your trailer brakes. Quick and easy to install, the systems come with a weather/corrosion resistant, heavy-duty polymer case to protect the battery and charger.

BREAKAWAY SYSTEM - FOR USE ON 1 & 2 AXLE TRAILERS W/ELECTRIC BRAKES

PART #	DESCRIPTION
851026 46.98 E	Includes 852018 Polymer Battery Case w/A-Frame or Post Mounting Bracket; 852023 Rechargeable Sealed 12v 5 Amp-hr. Lead Acid Battery & Terminals; 852005 Breakaway Switch



BREAKAWAY SYSTEM - FOR USE ON 1, 2, 3 & 4 AXLE TRAILERS W/ELECTRIC BRAKES

PART #	DESCRIPTION
852026 48.50 E	Includes 852018 Polymer Battery Case w/A-Frame or Post. Lead Acid Battery & Terminals; 852010 Breakaway Switch
8520005 41.40 E	Includes 852051 Lockable All Polymer Battery Case w/Flat. Lead Acid Battery & Terminals; 852010 Breakaway Switch



BREAKAWAY SYSTEM W/CHARGER - FOR USE ON 1 & 2 AXLE TRAILERS WITH ELECTRIC BRAKES

PART #	DESCRIPTION
851028 53.12 E	Includes 852018 Polymer Battery Case w/A-Frame or Post Mounting Bracket; 852023 Rechargeable Sealed 12v 5 Amp-hr. Lead Acid Battery & Terminals; 852005 Breakaway Switch;
851024 9.55 E	DC-to-DC Accelerated Battery Charging Device (ABCD)



BREAKAWAY SYSTEM WITH CHARGER - FOR USE ON 1, 2, 3 & 4 AXLE TRAILERS W/ELECTRIC BRAKES

PART #	DESCRIPTION
852028 61.56 E	Includes 852018 Polymer Battery Case w/A-Frame or Post Mounting Bracket; 852023 Rechargeable Sealed 12v 5 Amp-hr. Lead Acid Battery & Terminals; 852010 Breakaway Switch
8520015 56.71 E	Includes 852051 Lockable All Polymer Battery Case w/Flat Lead Acid Battery & Terminals; 852010 Breakaway Switch



PUSH TO TEST BREAKAWAY SYSTEM

Push to test: LEDs indicate fully charged, charging, or recharge • Multi-stage integrated charger provides a fast recharge up to 12.8 volts. Once battery is fully charged, the automatic float mode is designed to provide a continuous charge without overcharging • Activates trailer brakes upon separation of trailer and tow vehicle • For use on 1,2, or 3 axle trailers equipped with electric brakes • Weather/corrosion resistant, heavy-duty polymer case to protect battery and charger • Quick and easy to install • Breakaway switch w/7.5" lead wires • 5 amp/hr battery • Battery box, dimensions - 5" x 4.125" x 4" • Weight - 4.95 lbs. • Note: make sure battery is fully charged prior to towing

PART #	DESCRIPTION
85313 50.52 E	Push To Test Breakaway System w/Charger



SEALED LEAD ACID BATTERY

12v, sealed lead acid battery for use with Breakaway Systems on single, tandem and tri-axle trailers equipped with electric brakes. Battery requires periodic recharging to maintain optimum performance.

PART #	DESCRIPTION
852023 22.95 B	5 Amp-hr Sealed Battery



BATTERY CASES

Rust-proof heavy duty polymer cases protect battery and charger from elements and corrosion. Featuring U-shaped clamp style fastener on **852018** to mount over most trailer tongues, **852051** is a lockable case.

PART #	DESCRIPTION
852018 11.82 E	Battery Case - One-Bolt Installation on Jackpost or A-Frame
852051 6.21 E	Battery Case - Four-Bolt Installation on Flat Surface



tires & wheels
axles, hubs & springs
tongue accessories
hitches
electrical
brake parts
trailer hardware
locks & pins
towing & loading
tie downs
tools
chemicals

TRAILER

tires & wheels
axles, hubs & springs
tongue accessories
hitches
electrical
brake parts
trailer hardware
locks & pins
towing & loading
tie downs
tools
chemicals

TRAILER

BREAKAWAY SWITCHES

852010



Completely sealed breakaway switches to automatically set trailer brakes in case of accidental trailer breakaway. Required by law in some states. Emergency use only, not to be used to lock brakes when parked or stored. **852010**, and **852005** have reinforced nylon case, weldable metal tab, nylon pin assembly and are rust and corrosion free. **852009** has all metal parts and a brass pin assembly. Clamshell packaged.

PART #	DESCRIPTION
852010	8.94 E Breakaway Switch w/48" wires w/Cable & Nylon Pin Assembly
852005	8.90 E Breakaway Switch w/48" wires w/Cable & Nylon Pin Assembly (for use with 1-3 axle trailers)
852009	23.47 E Breakaway Switch w/48" wires w/Cable & Brass Pin Assembly
852010A	6.66 E 48" Replacement Cable & Nylon Pin Assembly (for 852010 Switch)
852009A	11.48 E 48" Replacement Cable & Brass Pin Assembly (for 852009 Switch)



BATTERY CHARGER

For all 12v battery systems with a 4 amp-hr minimum output. **851024** will return trailer breakaway system batteries to their maximum potential.

PART #	DESCRIPTION
851024	9.55 E DC-to-DC Accelerated Battery Charging Device (ABCD)



BATTERY POST ADAPTER

Battery Post Adapter for General Motors side post batteries. Allows stud for attaching accessories wires. Sold as a pair. Clamshell packaged.

PART #	DESCRIPTION
853194	16.77 E Side Post Adapters for General Motors



BATTERY ISOLATORS

Cadmium plated isolator with terminal nuts and lock-washers. 3 terminal isolator for metal frame ground systems, 4 terminal has insulated ground terminal for use with fiberglass or other non-conductive materials. Isolates starting battery, provides secondary battery current for auxiliary power and full time charging of both batteries. Clamshell packaged.

PART #	DESCRIPTION
857000	32.54 E Battery Isolator - 3 Terminal
857001	30.56 E Battery Isolator - 4 Terminal



857000

857001

CIRCUIT BREAKERS

Used in 6, 12, and 24v DC applications. Automotive, R.V., air conditioners, battery chargers, any application requiring over-current protection. Non-corrosive molded cover eliminates grounding when operating against a fault line. Includes mounting bracket and installed nuts and washers. Clamshell packaged.

PART #	DESCRIPTION
857010	8.33 E 15 Amp Circuit Breaker
857011	9.72 E 20 Amp Circuit Breaker
857012	8.48 E 30 Amp Circuit Breaker
857013	8.61 E 40 Amp Circuit Breaker
857022	8.69 E 50 Amp Circuit Breaker



ELECTROTEK® NON CONDUCTIVE DIELECTRIC SILICONE COMPOUND

ElectroTek® is to be used for all electrical connections, where a dielectric compound is required to prevent voltage loss from arcing and to protect contacts from corrosion. Suppresses radio frequency interference, dissipates heat, insulates trailer wiring connectors and seals out moisture. Effective for automotive, RV and marine electrical applications. Non-water soluble. 3 oz. tube. Clamshell packaged.

PART #	DESCRIPTION
857200	21.49 E 3 oz. tube ElectroTek®



DIELECTRIC GREASE

Using dielectric grease on electrical connectors helps prevent corrosion and increases reliability. Display packaged.

PART #	DESCRIPTION
LB11755	21.49 E 2 oz. tube dielectric grease



TRAILER BRAKE CONTROLS



AGILITY™

Packed with features to provide the ultimate ease in setting and adjusting for safe, smooth stops.

THE EASIEST TO USE ADVANCED BRAKE CONTROL AVAILABLE



Digital Sensitivity Adjustment
5 settings for different loads and driving conditions

Innovative Braking Override

Large Digital Readout
Easy to read 5-99% power scale

Digital Power/Gain
Easy to set, easy to adjust stopping force

Towing large trailers hinders your ability to stop quickly. Protect your trailer and vehicle investment with the Agility™ trailer brake control. Most states and provinces have specific laws requiring brakes on trailers depending on weight or stopping distance.

AGILITY™ PLUG-IN SIMPLE!®

The very best!

- Cuts installation time by hours
- Allows for quick removal
- Breaking capacity: Up to 8 trailer brakes



PART #		
647294	124.00	G

INSIGHT™ FLEX-MOUNT™ BRAKE CONTROL

Providing the Ultimate Braking Experience!

The InSIGHT™ brake control with Flex-Mount™ versatility solves the problem of inconvenient mounting while increasing user safety and convenience. This is achieved by bringing the display within the driver's line of sight and the controls within easy reach...**all with no tools required** and Plug-In Simple!® installation.

- Flex-Mount™ Versatility -- Multiple mounting locations in any vehicle
- No Tools Required Installation -- Plug-In Simple!® components
- Increased User Safety -- Keeps eyes on the road and controls within easy reach
- Advanced Proportional Technology -- Mirrors braking action of the towed vehicle for safe, smooth stops
- Digital LED Display -- Intuitive 0-99 scale of power setting
- 7 Sensitivity Settings for Advanced Braking Control
- Short Proof Protection for up to 8 Trailer Brakes
- Electric or Electric/Hydraulic Trailer Brake Compatibility
- Flex-Control™ features a soft glowing light for easy location at night



PART #		
620401	151.95	G

IMPULSE™ PLUG-IN SIMPLE!®

- Fully digital...settings for power level (gain) with built in time-ramp
- Easy to read digital power scale from 5% to 99%
- Ability to invert digital display if desired mount is upside down
- Breaking capacity: Up to 6 trailer brakes



PART #		
647235	103.40	G

RELIANCE™ PLUG-IN SIMPLE!®

- Fully digital...settings for power level (gain) with built in time-ramp
- Easy to read digital power scale from 5% to 99%
- Innovative vertical slide is easier to see and use than traditional horizontal slides
- Breaking capacity: Up to 4 trailer brakes



PART #		
647284	80.25	G

BRAKE-FORCE™ PLUG-IN SIMPLE!®

- L.E.D. indicator shows trailer connection, braking function and short circuit notification. L.E.D. gradually changes intensities of orange as power setting is increased
- Breaking capacity: Up to 4 trailer brakes



PART #		
647225	69.10	G

- tires & wheels
- axles, hubs & springs
- tongue accessories
- hitches
- electrical
- brake parts
- trailer hardware
- locks & pins
- towing & loading
- tie downs
- tools
- chemicals

TRAILER

PLUG-IN SIMPLE!® BRAKE CONTROL CONNECTORS



No cutting! no splicing!
Plug-in Simple® connectors
for quick install or removal
of Hopkins® brake controls:

Quick and Easy Installation

Many of today's vehicles come equipped with trailer towing packages that include a quick-connect brake control harness. Simply take our Plug-In Simple brake control connector and attach it to that harness, usually located under the driver's side dashboard. It's that easy.

- 620401 InSIGHT™
- 647294 Agility™
- 647284 Reliance™
- 647235 Impulse™
- 647225 BrakeForce™

(For vehicles equipped with a factory tow package.)



APPLICATION	YEAR	PART #		
BUICK				
Enclave	08-15	620404	22.95	G
CADILLAC				
Escalade	00	647795	16.80	G
Escalade	02-06	647795	16.80	G
Escalade / EXT / ESV	07-13	647685	13.95	G
CHEVROLET				
Avalanche	02-06	647795	16.80	G
Avalanche (4 pin)(5 pin)(6 pin)	07-13	647685	13.95	G
Silverado 1500 (New Body)	99-02	647795	16.80	G
Silverado 1500	03-07	647795	16.80	G
Silverado 1500 (New Body)	07-13	647685	13.95	G
Silverado 2500/3500 (New body style)	99-02	647795	16.80	G
Silverado 2500/3500	03-07	647795	16.80	G
Silverado 2500/3500 (New body style)	07-13	647685	13.95	G
Suburban	00-06	647795	16.80	G
Suburban (4 pin)(5 pin)(6 pin)	07-13	647685	13.95	G
Tahoe	00-06	647795	16.80	G
Tahoe (4 pin)(5 pin)(6 pin)	07-13	647685	13.95	G
Traverse	09-14	620404	22.95	G
CHRYSLER				
Aspen	07-09	647755	16.80	G
DODGE				
Dakota	97-11	647755	16.80	G
Durango	98-09	647755	16.80	G
Durango (w/ tow pkg)	11-12	620406	22.95	G
Ram Pickup (all sizes)	95-01	647755	16.80	G
Ram Pickup (cab & chassis only)	95-02	647755	16.80	G
Ram Pickup 1500	02-09	647755	16.80	G
Ram 1500 (w/ tow pkg) see also Ram	10-12	620405	22.95	G
Ram 1500 (w/ tow pkg) see also Ram	13-14	620407	22.95	G
Ram Pickup 2500/3500	02-09	647755	16.80	G
Ram Pickup 2500/3500 (w/ tow pkg) see also Ram	10-12	620405	22.95	G
FORD				
Bronco	94-96	647715	14.05	G
E-350 RV, E-450 RV	09-11	620403	22.95	G
Econoline Van	94-08	647715	14.05	G
Econoline Van	09-13	620403	22.95	G
Excursion	00-05	647715	14.05	G
Expedition (w/o tow)	97-03	647715	14.05	G

APPLICATION	YEAR	PART #		
FORD CONTINUED				
Expedition	97-03	647715	14.05	G
Expedition (w/ factory 4 flat)	00-02	647715	14.05	G
Expedition (w/ factory 7 blade)	99-12	647715	14.05	G
Expedition (w/ factory 7 blade)	13	620403	22.95	G
Explorer	00-13	647715	14.05	G
F-150, 250, 350	94-96	647715	14.05	G
F-150	97-08	647715	14.05	G
F-150 (w/ tow pkg)	09-14	620402	22.95	G
F-250 Light Duty (mfg. 1/96 - 10/96)	97	647715	14.05	G
F-250 Light Duty (mfg. 11/96 - 2001)	97-01	647715	14.05	G
F-250 Heavy Duty, F-350	94-97	647715	14.05	G
F-250 Heavy Duty, F-350	99-04	647715	14.05	G
F-250 Heavy Duty, F-350	05-07	647735	16.80	G
F-250, 350 All	08-15	620403	22.95	G
F-450 Heavy Duty, F-550	05-07	647735	16.80	G
F-450 Heavy Duty, F-550	08-15	620403	22.95	G
F-53 Motor Home Chasis	00-14	647715	14.05	G
Flex	09-11	647715	14.05	G
Flex	12-14	620402	22.95	G
Windstar	95-03	647715	14.05	G
GMC				
Acadia (w/o tow pkg)	07-14	620404	22.95	G
Denali	99-06	647795	16.80	G
Denali	07-13	647685	13.95	G
Sierra 1500 (New body style)	99-07	647795	16.80	G
Sierra 1500 (New body style)	07-13	647685	13.95	G
Sierra 2500/3500	03-07	647795	16.80	G
Sierra 2500/3500 (New body style)	07-13	647685	13.95	G
Yukon	00-06	647795	16.80	G
HONDA				
Pilot	09-15	647935	16.80	G
Ridgeline	06-12	647935	16.80	G
HUMMER				
H2	03-07	647795	16.80	G
H2	08-09	647685	13.95	G
INFINITI				
QX56 (w/ tow pkg), QX80	04-15	647635	16.80	G
JEEP				
Grand Cherokee (w/ tow pkg)	11-15	620406	22.95	G

PLUG-IN SIMPLE!® BRAKE CONTROL CONNECTORS CONTINUED

APPLICATION	YEAR	PART #	
LAND ROVER			
LR3	05-10	647715	14.05 G
LR4	10-11	647715	14.05 G
Range Rover	05-13	647715	14.05 G
LEXUS			
GX460	10-13	647815	16.80 G
GX470	03-10	647815	16.80 G
LX 570	08-13	647815	16.80 G
LINCOLN			
Aviator (w/ factory 4 flat)	03-05	647715	14.05 G
Aviator (w/ factory 7 blade)	03-05	647715	14.05 G
Mark LT	07-08	647715	14.05 G
MKT	10-11	647715	14.05 G
MKT	12-13	620402	22.95 G
Navigator	98-12	647715	14.05 G
Navigator	13-14	620403	22.95 G
MERCURY			
Mountaineer	02-10	647715	14.05 G

APPLICATION	YEAR	PART #	
NISSAN			
Armada	04-13	647635	16.80 G
Frontier Pickup	04-13	647635	16.80 G
NV Van	14	647635	16.80 G
Pathfinder	04-13	647635	16.80 G
Titan	04-13	647635	16.80 G
Xterra	04-13	647635	16.80 G
RAM			
Ram 1500 (w/ tow pkg)	10-12	620405	22.95 G
Ram 1500 (w/ tow pkg)	13-14	620407	22.95 G
Ram Pickup 2500/3500 (w/ tow pkg)	10-12	620405	22.95 G
SATURN			
Outlook	07-10	620404	22.95 G
TOYOTA			
Land Cruiser	03-10	647815	16.80 G
4-Runner	03-11	647815	16.80 G
Sequoia (w/ tow pkg) (MT)	03-13	647815	16.80 G
Tacoma	05-13	647815	16.80 G
Tundra	03-12	647815	16.80 G

QUICK REFERENCE BRAKE CONTROL WIRING GUIDE

NOTE: Locate wires on vehicle by function only. Not all vehicles are listed below. Refer to product instructions.

BRAKE CONTROL	1994-07 FORD	1999-06 CHEV/GM	2007-08 CHEV/GM	1997-02 DODGE	2003-07 DODGE	NISSAN	TOYOTA
BLUE (Electric Brake)	BLUE	DARK BLUE	BLUE	BLUE	BLUE	BROWN / WHITE	RED
BLACK (Battery)	RED	RED	RED / BLACK	RED	WHITE / RED	RED	BLACK / RED
RED (Brake Switch)	GREEN	LT. BLUE	LT. BLUE / WHITE	WHITE	BLUE / WHITE	RED / GREEN	GREEN / WHITE
WHITE (Ground)	WHITE	BLACK	WHITE	BLACK	GREEN / BLACK	BLACK	BROWN

SECOND VEHICLE MOUNTING KIT

For Impulse™ and BrakeForce™ brake controls



PART #
647685 13.95 G

ELECTRONIC BRAKE CONTROL INSTALLATION KIT

Everything needed to install most brake controls!

- 20 zip ties
- 4 butt splices
- 1 ring connector
- 1 splice connector
- 1 20' amp fuse/holder
- 15' black wire - 12 gauge
- 15' white wire - 12 gauge
- 25' blue wire - 12 gauge
- 3' red wire - 16 gauge



PART #
647275 33.00 G

tires & wheels
axles, hubs & springs
tongue accessories
hitches
electrical
brake parts
trailer hardware
locks & pins
towing & loading
tie downs
tools
chemicals

TRAILER

BREAK-AWAY KITS



BUILT-IN BATTERY METER WITH LED TEST LIGHTS

- Activates trailer brakes upon separation from tow vehicle
- Convenient test button verifies battery charge
- LEDs indicate: fully charged, re-charge, or charging
- Built-in battery charger
- Charges battery while plugged into vehicle
- 1 to 2 axle capacity
- 5 amp hour battery
- Trailer break-away kits are legally required in most states and provinces



ENGAGER™ BREAK-AWAY KIT STANDARD SIDE MOUNT - NO SCREWS

- 24" Wires, includes battery charger

PART #
620408 48.95 G



ENGAGER™ BREAK-AWAY KIT FLIP-TOP

- 24" wires, includes battery meter and charger

PART #
620409 53.95 G



WELDABLE MOUNTING PLATE

- For Engager™ Side-Mount (3 hole) Break-Away Kits
- Eliminates the need to drill holes in the trailer frame

PART #
620410 8.95 G



- For Engager™ Flip-Top (4-6 hole) Break-Away Kits
- Eliminates the need to drill holes in the trailer frame

PART #
620411 8.95 G



ENGAGER™ SM BREAK-AWAY KIT WITH BATTERY METER

Complete system includes charger, switch, cable / pin, and mounting screws

PART #
620099 56.15 G



ENGAGER™ FT BREAK-AWAY KIT WITH BATTERY METER

Complete system includes charger, switch, cable / pin, and mounting screws

PART #
620400 56.15 G



L.E.D BREAKAWAY SWITCH

- Safety feature
- Indicates 12-volt power is being transferred to the trailer brakes
- Weatherproof design

L.E.D. BREAK-AWAY SWITCH
7" Length

PART #
620050 13.45 G



L.E.D. BREAK-AWAY SWITCH
44" Length

PART #
620060 12.40 G

REPLACEMENT CABLE & PIN

For use only with:
L.E.D. break-away switches 620050 and 620060

PART #
620052 6.45 G



BREAKAWAY SWITCH



L.E.D. BREAK-AWAY SWITCH
7" Length

PART #
620005 13.25 G

L.E.D. BREAK-AWAY SWITCH
44" Length

PART #
620014 10.20 G

REPLACEMENT BREAK-AWAY CABLE & PIN

For use only with:
Standard break-away switches 620005, 620014

PART #
620009 6.45 G



BREAK-AWAY KIT

WITH CHARGER, SWITCH AND HARDWARE KIT

Rustproof, plastic case protects battery and charger. For use on single and tandem axle trailers with electric brakes.

PART #
620001 47.90 G



BATTERY CHARGER

PART #
620007 6.95 G



BOX & HARDWARE

PART #
620006 17.60 G

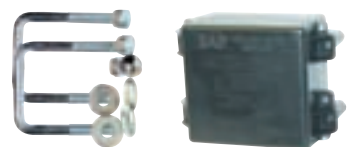

TRAILER



MAGNET KITS



855101 39.98 A

WHITE WIRES

Length 3-1/8
Width 2
Thickness 15-16
Fits or Replaces
Hayes 10 x 1-5/8
10 x 2-1/4
12 x 2

(All - Replaces in Pairs)
(All - After Late 1994)



855114 52.24 E

BLACK WIRES

Length 3-1/8
Width 2
Thickness 15/16
Fits or Replaces
Dexter 12 x 2 - 7K Axles



855118 43.15 E

YELLOW WIRES

Length 3-1/8
Width 2
Thickness 15/16
Fits or Replaces
Dexter 10 x 1-1/2
(After Mid 1988)

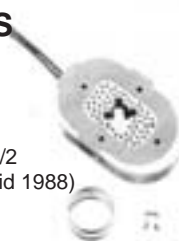

855109 54.63 E

WHITE WIRES

Length 3-1/8
Width 2
Thickness 15-16
Fits or Replaces
Dexter 12 x 2
Hayes 12 x 2
(After late 1987)
Trailer Pac 103
Tow Craft 1103-100-018



856106 49.21 E

LIGHT GREEN WIRES

Length 3-1/8
Width 2
Thickness 15/16
Fits or Replaces
AL-KO Kober 10 x 2-1/4



855106 52.65 E

GREEN WIRES

Length 3-1/8
Width 2
Thickness 15/16
Fits or Replaces
Dexter 10 x 2-1/4
Hayes 10 x 2-1/4
(After Mid 1987)
Hayes 10 x 1-5/8
(After to Mid to 1987)
Trailer Pac 102
Tow Craft 1103-100-017



855113 46.30 E

WHITE WIRES

Length 2 1/16
Width 1 15/16
Thickness 3/4
Fits or Replaces
Dexter 12 x 1-1/2
(Prior to Mid 1988)
Dexter 7 x 1-1/4
(After April 1990)



855109 54.63 E

WHITE WIRES

Length 3-1/8
Width 2
Thickness 15/16
Fits or Replaces
AL-KO Kober 12 x 2 6K & 7K



BEARING & CUP SETS

• Sold each



CUP/CONE	PART #		
L14276/L14125A	LM14125CC	11.15	L
L15245/L15123	LM15123CC	9.40	L
L25520/L25580	LM25580CC	14.85	L
L44610/L44643	LM44643CC	6.30	L
LM48510/LM48548	LM48548CC	10.25	L
LM67010/LM67048	LM67048CC	7.20	L
L68111/L68149	LM68149CC	7.45	L
L11910/L11949	LM11949CC	8.30	L

REPLACEMENT PARTS THAT DO NOT APPEAR IN EXPLODED VIEW

MAGNET RETAINING RING

10 x 1-5/8 Hayes
10 x 2-1/4 Hayes
(Old Style)
12 x 2 Hayes
(Old Style)

855120 8.52 B

ADJUSTING SLOT PLUG (CAPS) ALL SYSTEMS

855410 4.50 B

ADJUSTING SCREW SPRING

10 x 1-5/8 Hayes
10 x 1-1/2 Dexter
10 x 2-1/4 Hayes
10 x 2-1/4 Dexter
10 x 2-1/4 Fayette
12 x 2 Hayes
12 x 2 Dexter
12 x 2 Fayette

855407 6.54 E

MAGNET IDENTIFICATION

MAGNETS CAN BE IDENTIFIED BY THE COLOR OF THE WIRE USED

Dexter 7" x 1-1/4"

The magnets are round. Prior to April 1990 they had yellow wires, after 1990 the magnet has white wires. Replacement of magnets will need to be done in pairs and updated to the new magnet along with the lever. The early levers are weak and will bend and hang up as they wear.

Dexter 10" x 1-1/2"

The magnet wires for the early model round magnets are white and the late model oval magnets are yellow.

Hayes 10" x 1-5/8"

The magnet wires for the early model round magnets are red and the late model oval magnets are green.

AL-KO 10" x 2-1/4"

It will have light green wires.

Hayes 10" x 2-1/4"

The early model round will have red wires and the late model will have oval green wires.

Dexter 10" x 2-1/4"

It uses green wires.

Fayette 10" x 2-1/4"

The round magnets will have white wires (obsolete).

AL-KO 12" x 2"

It will have white wires.

Hayes 12" x 2"

The early model round magnet will have red wires, the late model will be an oval magnet with white wires.

Dexter 12" x 2"

It will have white wires.

Dexter Centerline 12" x 2"

The 4.5K axles will have red orange wires, the 6/7K axles will have red wires (obsolete for both sizes).

- tires & wheels
- axles, hubs & springs
- tongue accessories
- hitches
- electrical
- brake parts
- trailer hardware
- locks & pins
- towing & loading
- tie downs
- tools
- chemicals

TRAILER

BRAKE PARTS

- tires & wheels
- axles, hubs & springs
- tongue accessories
- hitches
- electrical
- brake parts**
- trailer hardware
- locks & pins
- towing & loading
- tie downs
- tools
- chemicals

ALKO 10" x 2-1/4"

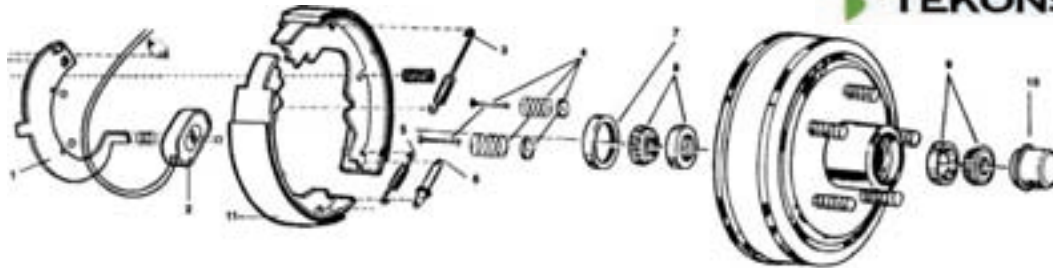

PART #			REF #	DESCRIPTION
856205	13.50	B	1	Actuating Lever - R.H.
856206	20.41	B	1	Actuating Lever - L.H.
856106	49.21	E	2	Magnet Kit
855304	8.16	E	3	Return Spring Set (Axle Set)
855353	10.83	E	4	Hold Down Kit (Axle Set)
855404	11.43	E	5,6	Adjusting Screw Kit (Spring & Screw Assembly)
856709	92.97	E		Complete Assembly - L.H.
856710	92.97	E		Complete Assembly - R.H.
GS545138	1.60	L	7	Grease Seal (each)
GCP10	1.98	L	10	Grease Cap (each)
LM68149CC	7.45	L	8	Bearing Set - Inner LM68111, LM68149
N/A			9	Bearing Set - Outer LM44649, LM44610
TBK9	12.95	G	7,8,9,10	Bearing/Seal Kit
856004	44.83	E	11	Shoe and Lining Kit

ALKO 12" x 2"

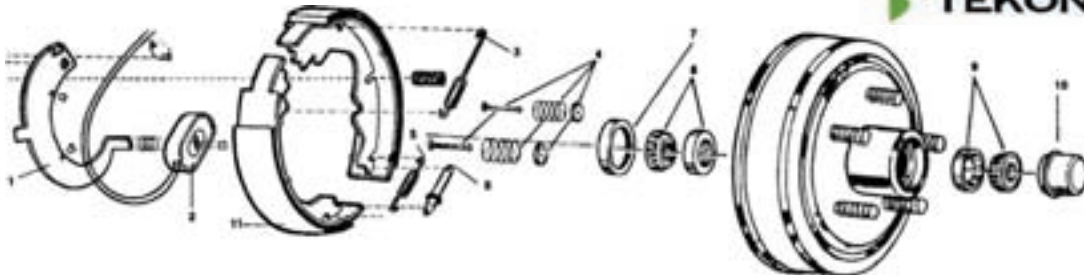

PART #			REF #	DESCRIPTION
856211	20.83	B	1	Actuating Lever - R.H.
856212	20.83	B	1	Actuating Lever - L.H.
856109	51.06	E	2	Magnet Kit
855307	9.40	E	3	Single Refractor
855353	10.83	E	4	Hold Down Kit (Axle Set)
855404	11.43	E	5,6	Adjusting Screw Kit (Spring & Screw Assembly)
856713	117.08	E		Complete Assembly - L.H.
856714	117.08	E		Complete Assembly - R.H.
855605	1.60	G	7	Grease Seal (each)
856658	10.21	E	10	Grease Cap for LM14125CC (each)
855652	5.72	E	10	Grease Cap for LM15123CC
LM25580CC	14.85	L	8	Bearing Set - Inner
LM14125CC	11.15	L	9	Bearing Set - Outer Large Bore LM14125A, LM14276
LM15123CC	9.40	L	9	Bearing Set - Outer Small Bore LM15123, LM15245
856005	45.61	E	11	Shoe and Lining Kit

TRAILER

DEXTER 7" x 1-1/4"

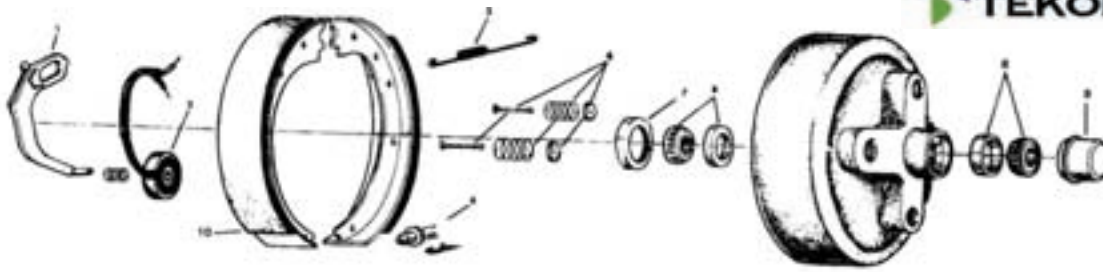

PART #			REF #	DESCRIPTION
N/A			1	Actuating Lever - R.H.
N/A			1	Actuating Lever - L.H.
855113***	46.30	E	2	Magnet Kit
855320	30.27	E	3	Return Spring
SOLD ONLY AS A KIT			4	Hold Down Clips
			5	Adjusting Screw Spring
			6	Adjusting Screw Assembly
GS203025	1.35	L	7	Seal - BTR (each)
GCP10	1.98	L	9	Grease Cap (each)
N/A			8	Bearing Set - Inner & Outer LM44649, LM44610
TBK9	12.95	G	7,8,9	Bearing/Seal Kit
855002	51.11	E	10	Shoe and Lining Kit

***After 4-90 to accommodate lever revision

DEXTER 10" x 1-1/2"

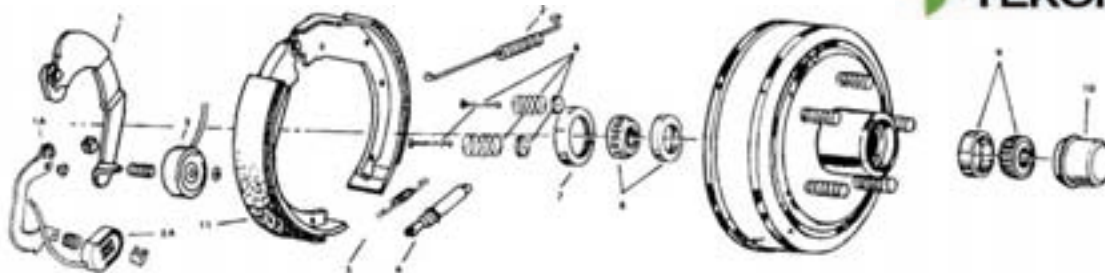

PART #			REF #	DESCRIPTION
N/A			1	Actuating Lever - R.H.
855231**	13.50	B	1A	Actuating Lever - R.H.
N/A			1	Actuating Lever - L.H.
855232**	13.50	B	1A	Actuating Lever - L.H.
855113*	46.30	E	2	Magnet Kit
855118*	43.15	E	2A	Magnet Kit
855306	8.30	E	3	Return Spring Set (Axle Set)
N/A			4	Hold Down Kit (Axle Set)
855404	11.43	E	5,6	Adjusting Screw Kit (Spring & Screw Assembly)
855607	7.36	E	7	Grease Seal (each)
GCP10	1.98	L	10	Grease Cap (each)
LM67048CC	7.20	L	8	Bearing Set - Inner LM67048, LM67010
N/A			9	Bearing Set - Outer LM44649, LM44610
855009	75.91	E	11	Shoe and Lining Kit (Axle Set)

* Prior to Mid 1988 ** After Mid 1988

tires & wheels

axles, hubs & springs

tongue accessories

hitches

electrical

brake parts

trailer hardware

locks & pins

towing & loading

tie downs

tools

chemicals

TRAILER

BRAKE PARTS

DEXTER 10" x 2-1/4"

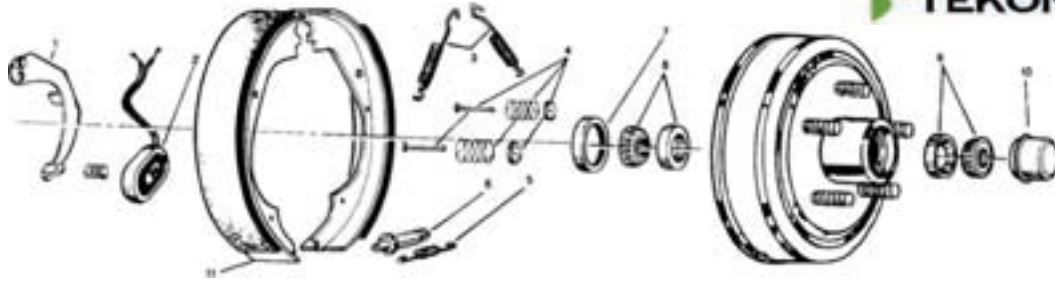

PART #			REF #	DESCRIPTION
N/A			1	Actuating Lever - R.H.
N/A			1	Actuating Lever - L.H.
855106	52.65	E	2	Magnet Kit
855305	8.73	E	3	Return Spring Set (Axle Set)
855353	10.83	E	4	Hold Down Kit (Axle Set)
855404	11.43	E	5,6	Adjusting Screw Kit (Spring & Screw Assembly)
855707	93.80	E		Complete Brake Assembly - L.H.
855708	93.80	E		Complete Brake Assembly - R.H.
GS545138	1.60	L	7	Grease Seal (each)
GCP10	1.98	L	10	Grease Cap (each)
LM48548CC	10.25	L	8	Bearing Set - Inner (Prior to Dec. 1983) LM48510, LM48548
LM68149CC	7.45	L	9	Bearing Set - Outer (After Dec. 1983) LM68111, LM68149
N/A			9	Bearing Set - Outer LM44649, LM44610
855003	49.63	E	11	Shoe and Lining Kit

DEXTER 12" x 2"

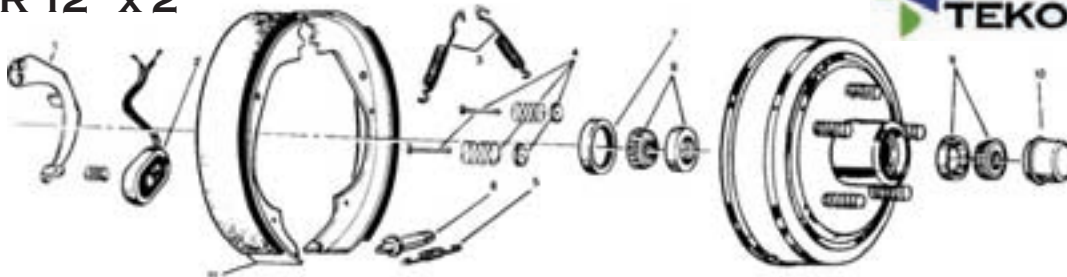

PART #			REF #	DESCRIPTION
N/A			1	Actuating Lever - R.H.
N/A			1	Actuating Lever - L.H.
855109	54.63	E	2	Magnet Kit
See 3A/3B			3	Return Spring Set (Axle Set)
855307	9.40	E	3A	Single Retractor
855305	8.73	E	3B	Dual Retractor
855353*	10.83	E	4	Hold Down Kit (Axle Kit)
855404	11.43	E	5,6	Adjusting Screw Kit (Spring & Screw Assembly)
855606	2.10	G	7	Grease Seal (each)
855652	5.72	E	10	Grease Cap (each)
LM25580CC	14.85	L	8	Bearing Set - Inner LM25520, LM25580
LM67048CC	7.20	L	9	Bearing Set - Outer LM67048, LM67010
855000D	48.79	E	11	Shoe and Lining Kit
855711	112.74	E		Complete Brake Assembly - L.H.
855712	112.74	E		Complete Brake Assembly - R.H.

* Replacement Kit Uses Coil Springs

- tires & wheels
- axles, hubs & springs
- tongue accessories
- hitches
- electrical
- brake parts**
- trailer hardware
- locks & pins
- towing & loading
- tie downs
- tools
- chemicals

TRAILER

DEXTER 12" x 2" 7K



PART #	REF #	DESCRIPTION
N/A	1	Actuating Lever - R.H.
N/A	1	Actuating Lever - L.H.
855114	52.24 E 2	Magnet Kit
855305	8.73 E 3	Return Spring Set (Axle Set)
855353	10.83 E 4	Hold Down Kit (Axle Set)
855404	11.43 E 5,6	Adjusting Screw Kit (Spring & Screw Assembly)
855606	2.10 G 7	Grease Seal (each)
855652	5.72 E 10	Grease Cap (each)
LM25580CC	14.85 L 8	Bearing Set - Inner LM25520, LM25580
N/A	9	Bearing Set - Outer (865 Hub) LM14125A, LM14276 (Large Bore)
LM15123CC	9.40 L 9	Bearing Set - Outer (UTG Hub) LM15123, LM15245 (Small Bore)
855010	66.54 E 11	Shoe and Lining Kit

HAYES 10" x 1-5/8"

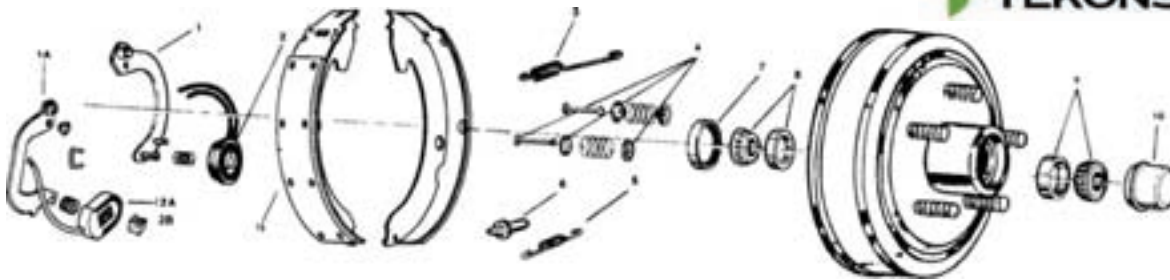

PART #	REF #	DESCRIPTION
N/A	1	Actuating Lever - R.H.
N/A	1A	Actuating Lever - R.H.
N/A	1	Actuating Lever - L.H.
N/A	1A	Actuating Lever - L.H.
N/A	2	Magnet Kit (4.5K Axles)
855106**	52.65 E 2A	Magnet Kit (6K & 7K Axles)
855101***	39.98 A 2B	Magnet Kit - White Wire
855304	8.16 E 3	Return Spring Set (Axle Set)
855404	11.43 E 5,6	Adjusting Screw Kit (Spring & Screw Assembly)
GS545138	1.60 L 7	Seal (Axle Set) (each)
GCP10	1.98 L 10	Grease Cap (Axle Set) (each)
LM67048CC	7.20 L 8	Bearing Set - Inner LM67048, LM67010
N/A	9	Bearing Set - Outer LM44649, LM44610
N/A	11	Shoe and Lining Kit

* Replace Lever and Use 5106 Magnet ** After Mid 1987 *** After late 1994

- tires & wheels
- axles, hubs & springs
- tongue accessories
- hitches
- electrical
- brake parts
- trailer hardware
- locks & pins
- towing & loading
- tie downs
- tools
- chemicals

TRAILER

BRAKE PARTS

HAYES 10" x 2-1/4"

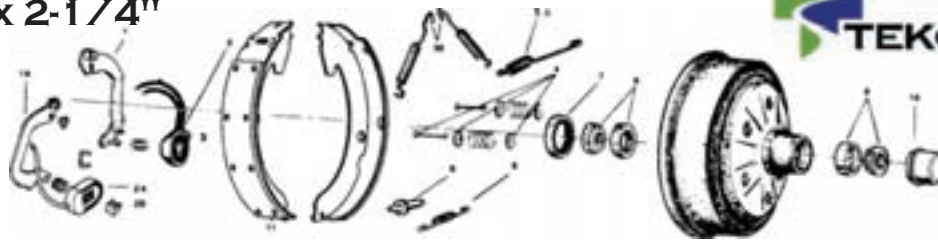

PART #			REF #	DESCRIPTION
N/A			1	Actuating Lever - R.H.
855205**	13.50	B	1A	Actuating Lever - R.H.
N/A			1	Actuating Lever - L.H.
855206**	13.50	B	1A	Actuating Lever - L.H.
N/A			2	Magnet Kit
855106**	52.65	E	2A	Magnet Kit
855101	39.98	A	2B	Magnet Kit - White Wire Late 1994
855304	8.16	E	3A	Single Retractor
855305****	8.73	E	3B	Dual Retractor
855353	10.83	E	4	Hold Down Kit (Axle Set)
855404	11.43	E	5,6	Adjusting Screw Kit (Spring & Screw Assembly)
GS545138	1.60	L	7	Grease Seal (each)
GCP10	1.98	L	10	Grease Cap (each)
LM68149CC***	7.45	L	8	Bearing Set - Inner LM68111, LM68149
N/A			9	Bearing Set - Outer LM44649, LM44610
856004	44.83	E	11	Shoe and Lining Kit
N/A				Complete Brake Assembly - L.H.
855710	115.95	E		Complete Brake Assembly - R.H.

* Prior to Mid 1987 ** After Mid 1987 *** After 1972 **** Prior to May 1977

HAYES 12" x 2"

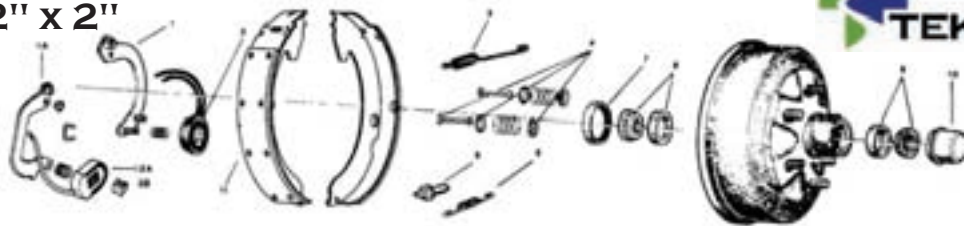

PART #			REF #	DESCRIPTION
N/A			1	Actuating Lever - R.H.
855211**	20.83	B	1A	Actuating Lever - R.H.
N/A			1	Actuating Lever - L.H.
855212**	20.83	B	1A	Actuating Lever - L.H.
N/A			2	Magnet Kit
855109*	54.63	E	2A	Magnet Kit
855101	39.98	A	2B	Magnet Kit - White Wire Late 1994
855307	9.40	E	3	Return Spring et (Axle Set)
855353	10.83	E	4	Hold Down Kit (Axle Kit)
855404	11.43	E	5,6	Adjusting Screw Kit (Spring & Screw Assembly)
855605	1.60	G	7	Grease Seal (each)
855652	5.72	E	10	Grease Cap (each)
LM25580CC	14.85	L	8	Bearing Set - Inner LM25520, LM25580
LM67048CC	7.20	L	9	Bearing Set - Outer LM67048, LM67010
855000H	39.50	A	11	Shoe and Lining Kit (Axle Set)

* Prior to Mid 1987 ** After Mid 1987

- tires & wheels
- axles, hubs & springs
- tongue accessories
- hitches
- electrical
- brake parts**
- trailer hardware
- locks & pins
- towing & loading
- tie downs
- tools
- chemicals

HAYES 12" X 2" CENTERLINE

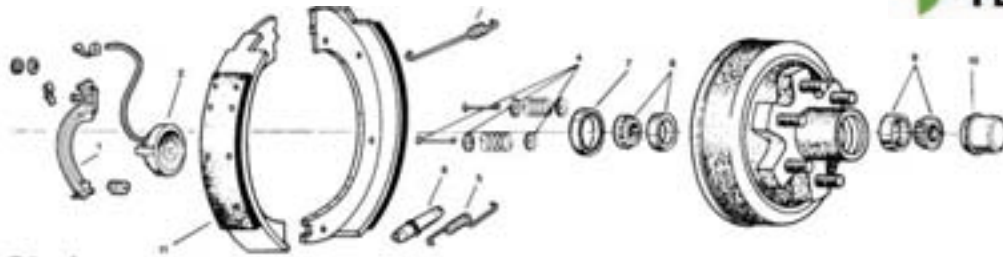

PART #			#	DESCRIPTION
N/A			1	Actuating Lever - R.H.
N/A			1	Actuating Lever - L.H.
N/A			1	Actuating Lever - R.H.
N/A			1	Actuating Lever - L.H.
N/A			2	Magnet Kit (4.5K Axles)
N/A			2	Magnet Kit (6K & 7K Axles)
N/A			3	Return Spring Set (Axle Set)
855353	10.83	E	4	Hold Down Kit (Axle Set)
855404	11.43	E	5,6	Adjusting Screw Kit (Spring & Screw Assembly)
855605	1.60	G	7	Grease Seal (each)
855652	5.72	E	10	Grease Cap (each)
LM25580CC	14.85	L	8	Bearing Set - Inner LM25520, LM25580
LM67048CC	7.20	L	9	Bearing Set - Outer LM67048, LM67010
N/A			11	Shoe and Lining Kit

FAYETTE 10" x 2-1/4"

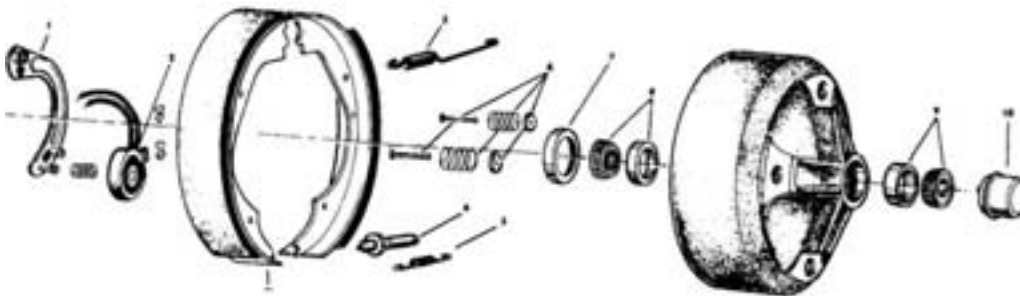

PART #			REF #	DESCRIPTION
N/A			1	Actuating Lever - R.H.
N/A			1A	Actuating Lever - R.H.
N/A			2	Magnet Kit
855304	8.16	E	3	Return Spring et (Axle Set)
855353*	10.83	E	4	Hold Down Kit (Axle Kit)
855404	11.43	E	5,6	Adjusting Screw Kit (Spring & Screw Assembly)
GS545138	1.60	L	7	Grease Seal (each)
GCP10	1.98	L	10	Grease Cap (each)
LM68149CC	7.45	L	8	Bearing Set - Inner LM68111, LM68149
N/A			9	Bearing Set - Outer LM44649, LM44610
TBK9	12.95	G	7,8,9,10	Bearing/Seal Kit
N/A			11	Shoe and Lining Kit

* Contained in Hardware Kit (Axle Kit)

- tires & wheels
- axles, hubs & springs
- tongue accessories
- hitches
- electrical
- brake parts**
- trailer hardware
- locks & pins
- towing & loading
- tie downs
- tools
- chemicals

TRAILER

BRAKE PARTS

FAYETTE 12" x 2"

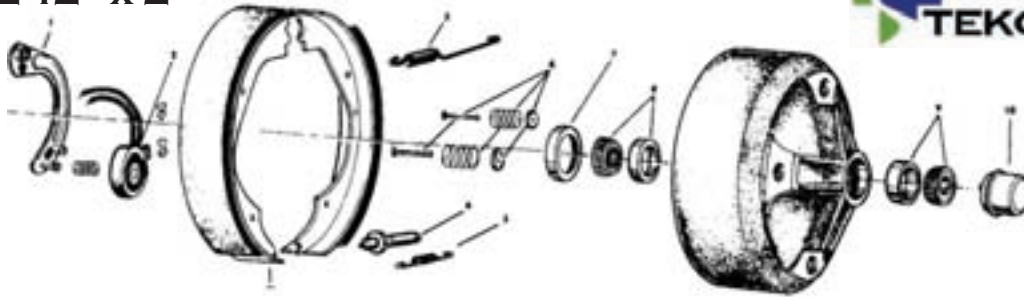

PART #	REF #	DESCRIPTION
N/A	1	Actuating Lever - R.H.
N/A	1	Actuating Lever - L.H.
N/A	2	Magnet Kit
855307	9.40 E 3	Return Spring Set (Axle Set)
855353*	10.83 E 4	Hold Down Kit (Axle Set)
855404	11.43 E 5,6	Adjusting Screw Kit (Spring & Screw Assembly)
N/A	1	Actuating Lever - R.H.
N/A	1	Actuating Lever - L.H.
N/A	2	Magnet Kit
855307	9.40 E 3	Return Spring Set (Axle Set)
855353*	10.83 E 4	Hold Down Kit (Axle Set)
855404	11.43 E 5,6	Adjusting Screw Kit (Spring & Screw Assembly)

- Replacement Kit Uses Coil Springs
- Bonded Shoes

G5 STAINLESS STEEL DISC BRAKE

- 3500# Axle 5 Lug 9.6" Rotor, For 13", 14" or 15" Wheels, Replaces 10" Drum Brakes.
- All Aluminum Caliper: 380 series Aluminum w/E-Coat, sheds heat five times faster than cast iron
- 304 Stainless Steel Rotor with Venting Holes, Diameter: 9.6" x .3125"
- Pre-greased hub includes bearings & seal. Uses lithium based or lithium compatible.
- Hub Specs: 1,750# cap, 5 on 4.5" Hub Finish - GalvX Bearing Size: Outer 1 1/16" (L44649) Inner 1 3/8" (L68149) includes mounting bracket and lug nuts



276003 221.66 B

10" G4.5 DISC BRAKE UPGRADE KIT

Single piston aluminum caliper, patented bimetal aluminum/stainless piston, oil impregnated bronze bushings ceramic pads with stainless steel backing plates stainless steel slider pins, GalvX coated hub and galvanized mounting bracket.

- Precision bearings, seals and grease factory installed
- Factory pre-installed stainless steel slider pins
- Each kit is for one wheel, includes mounting bracket
- Stainless steel rotor with venting holes for faster cooling
- G4.5 upgrade kits replaces G4 caliper with G5 caliper with lifetime pads
- Includes: Caliper, GalvX mounting bracket and ceramic pads



276004 155.35 B

REPLACEMENT PARTS



FREE BACKING SOLENOID

LR81103 83.05 G



10" AND 12" BRAKE PAD SET Set of 4

LR81100 51.01 G



FLEXIBLE BRAKE LINE KIT

- Rated at 3000 PSI
- 24" long
- 2 hoses with brass filling

LR81099 65.15 G

- tires & wheels
- axles, hubs & springs
- tongue accessories
- hitches
- electrical
- brake parts
- trailer hardware
- locks & pins
- towing & loading
- tie downs
- tools
- chemicals

BRAKE COMPONENT PARTS

ELECTRIC BRAKE ASSEMBLIES

- Assemblies include backing plate shoe and lining, magnets, & actuating lever
- Adjusting screw and spring hardware units come completely assembled



Replace in Pairs {	855707	93.80	E	10" x 2-1/4"	L.H. Dexter Assembly
	855708	93.80	E	10" x 2-1/4"	R.H. Dexter Assembly
	855709	----		10 x 2-1/4"	L.H. Hayes Assembly
	855710	115.95	E	10" x 2-1/4"	R.H. Hayes Assembly
Replace in Pairs {	855711	112.74	E	12" x 2"	L.H. Dexter Assembly
	855712	112.74	E	12" x 2"	R.H. Dexter Assembly
	855713	131.24	E	12" x 2"	L.H. Hayes Assembly
	855714	131.24	E	12" x 2"	R.H. Hayes Assembly
	856709	92.97	E	10" x 2-1/4"	L.H. ALKO Assembly
	856710	92.97	E	10" x 2-1/4"	R.H. ALKO Assembly
	856713	117.08	E	12" x 2"	L.H. ALKO Assembly
	856714	117.08	E	12" x 2"	ALKO Assembly



ELECTRIC BRAKE ASSEMBLIES

- Replaces Dexter Electric Trailer Brake Assemblies
- Units are assembled
- Assemblies include: Backing Plate, Shoe and Linings, Magnets, Actuating Lever, Adjusting Screw and Spring Hardware.

444211	57.37	B	10 x 2 1/4 Right Hand Brake Assembly
444212	57.37	B	10 x 2 1/4 Left Hand Brake Assembly
444213	67.36	B	12 x 2 Right Hand Brake Assembly
444214	67.36	B	12 x 2 Left Hand Brake Assembly



BRAKE ASSEMBLY MOUNTING BOLTS

855720	6.81	E	3/8" Brake Assembly Mounting Bolt • Set of 5 • Used on 5 bolt mounting patterns
855721	6.01	E	7/16" Brake Assembly Mounting Bolt • Set of 4 • Used on 4 bolt mounting patterns



UNI-SERVO HYDRAULIC BRAKE ASSEMBLIES



PART #		PART #				SIZE	CAPACITY
LEFT SIDE		RIGHT SIDE					
RL0700	84.75	G	RL0702	89.95	G	7" x 1-3/4"	1250#
RL1000	85.10	G	RL1002	85.10	G	10" x 2-1/4"	1850#
RL1200	102.80	G	RL1202	102.80	G	12" x 2"	2600#

FLANGE				ZINC PLATED FLANGE	
BOLTS (sold each)		SIZE		LOCK NUTS (sold each)	
N/A		7/16-20		RL439 (4 per brake)	0.70 G
RL437 (4 per brake)	0.70	L	7/16-20	RL439 (4 per brake)	0.70 G
RL375 (5 per brake)	0.55	L	3/8-16	RL379 (5 per brake)	0.25 H



- Note: Flange bolts and lock nuts are not included with the brake and must be ordered separately

- tires & wheels
- axles, hubs & springs
- tongue accessories
- hitches
- electrical
- brake parts
- trailer hardware
- locks & pins
- towing & loading
- tie downs
- tools
- chemicals

TRAILER

BRAKE COMPONENT PARTS

BRAKE DRUM



- 5 stud on 4-1/2"
- E-coated
- Use with hub HSH545
- Recommended for use with 13", 14", and 15" wheels
- 10" drum diameter
- Inner bearing LM68149 (1-3/8"), outer bearing LM44649 (1-1/16")

PART #	DESCRIPTION		
RL51009	71.35	E	Brake Drum



DISC BRAKE ROTOR

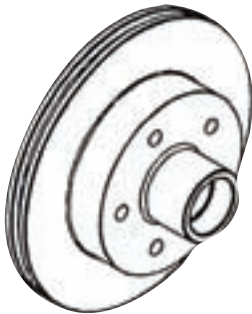

- 5 stud on 4-1/2"
- E-coated

PART #	DESCRIPTION		
RL91001	67.90	E	Brake Rotor
RL91100	129.45	G	L.H. Disc Brake Caliper Assembly
RL91102	129.45	G	R.H. Disc Brake Caliper Assembly



DRUM HUBS



- Hubs are designed to work with hydraulic or electric drum brakes
- Painted brake drum hubs for greater corrosion resistance
- Drum hub only with cups and studs

PART #	HUB	CIRCLE
LR81004	82.21	G 5 Stud 10"
LR81003	93.41	G 6 Stud 12"



TRAILER BRAKE ADJUSTMENT**

Brakes should be adjusted after the first 200 miles of operation when the brake shoes and drums have "seated" and at 3000 mile intervals, or as use and performance requires. The brakes should be adjusted in the following manner:

1. Jack up trailer and secure on adequate capacity jack stands. Follow trailer manufacturers recommendations for lifting and supporting the unit. Check that the wheel and drum rotate freely.

WARNING: Do not lift or support trailer on any part of the axle or the suspension system.

2. Remove the adjusting hole cover from the adjusting slot on the bottom of the brake backing plate.
3. With a screwdriver or standard adjusting tool, rotate the starwheel of the adjuster assembly to expand the brake shoes. Adjust the brake shoes out until the pressure of the linings against the drum makes the wheel very difficult to turn.

Note: With drop spindle axles, a modified adjusting tool with about an 80 degree angle should be used.

4. Then rotate the starwheel in the opposite direction until the wheel turns freely with a slight lining drag.
5. Replace the adjusting hole cover and lower the wheel to the ground.
6. Repeat the above procedure on all brakes.

WARNING: Never crawl under your trailer unless it is resting on properly placed jack stands.

Follow the trailer manufacturers recommendations for lifting and supporting the unit. Do not lift or place supports on any part of the suspension system.

****Note: Trailer Brake Adjustment procedures courtesy Dexter Axle.**

- tires & wheels
- axles, hubs & springs
- tongue accessories
- hitches
- electrical
- brake parts
- trailer hardware
- locks & pins
- towing & loading
- tie downs
- tools
- chemicals

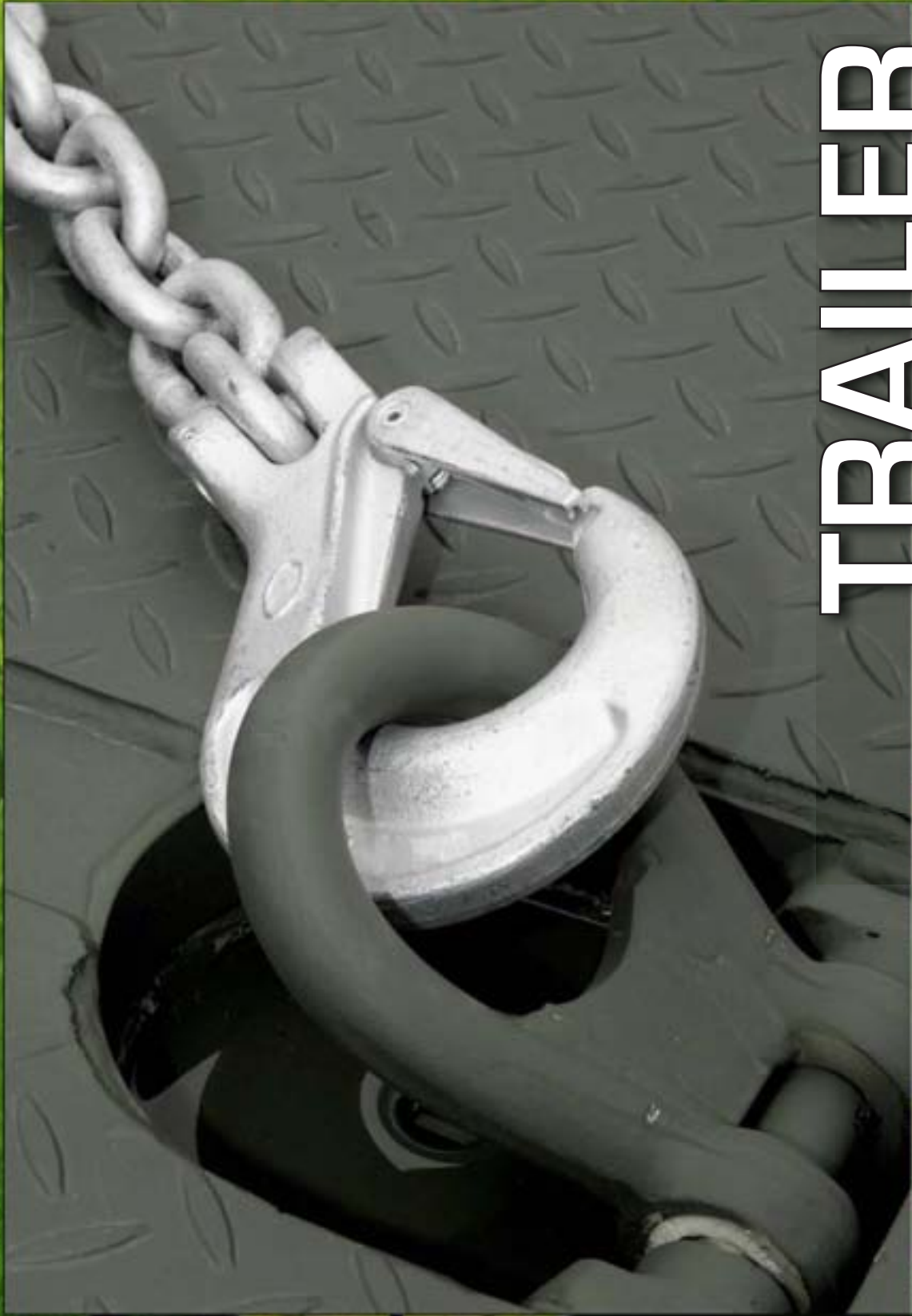

TRAILER HARDWARE



TRAILER HARDWARE

- tires & wheels
- axles, hubs & springs
- tongue accessories
- hitches
- electrical
- brake parts
- trailer hardware
- locks & pins
- towing & loading
- tie downs
- tools
- chemicals

ERICKSON RECESSED RINGS

PART #	MFG #	DESCRIPTION	MAX LOAD		
			RATING	UM	
EK59109	59109	RECESSED RING ROUND BULK	1200#	EA	3.70 G
EK9128	09128	RECESSED ANCHOR RING PACKAGED	1200#	EA	6.25 G
EK59128	59128	RECESSED ANCHOR RING BULK	1200#	EA	4.80 G
EK9114	09114	HEAVY DUTY RECESSED RING PACKAGED	5000#	EA	14.95 G
EK59114	59114	HEAVY DUTY RECESSED RING BULK	5000#	EA	10.20 G
EK9098	09098	RECESSED OVAL ANCHOR PACKAGED	1200#	EA	5.95 G
EK59098	59098	RECESSED OVAL ANCHOR BULK	1200#	EA	4.95 G
EK9097	09097	HEAVY DUTY RECESSED OVAL ANCHOR PACKAGED	5000#	EA	8.65 G
EK59097	59097	HEAVY DUTY RECESSED OVAL ANCHOR BULK	5000#	EA	5.35 G
EK59130	59130	HEAVY DUTY SWIVEL RECESSED RING BULK	5000#	EA	20.05 G
EK9110	09110	RECESSED RING PACKAGED	1200#	EA	5.55 G
EK59110	59110	RECESSED ROUND BULK	1200#	EA	3.15 G



EK9110
EK59110



EK9109
EK59109



EK9128
EK59128

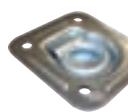

EK9114
EK59114



EK9098
EK59098



EK9097
EK59097



EK9130

Buyers RECESSED RINGS

PART #	MFG #	DESCRIPTION	SAFE LOAD		
			RATING	UM	
BY601	B601U	3" DIAMETER MOUNTING HOLE REQUIRED ZINC PLATED DISPLAY PACKAGED	285#	EA	2.95 H
BY501	B501	SURFACE MOUNTED STEEL PAN WITH 1/4" DIAMETER RING ZINC PLATED BULK	500#	EA	2.95 H
BY701	B701	3" DIAMETER MOUNTING HOLE REQUIRED ZINC PLATED DISPLAY PACKAGED	265#	EA	2.00 H
BY701S	B701SM	3" DIAMETER MOUNTING HOLE REQUIRED ZINC PLATED DISPLAY PACKAGED	265#	EA	1.95 H
BY703	B703	SURFACE/RECESSED ZINC PLATED ROPE RING	500#	EA	1.95 H
BY705	B705	PLASTIC PAN WITH 1/4" DIA. RING BULK	1000#	EA	1.95 H
BY8011	B801A	FORMED 1/8" STEEL PAN ZINC PLATED DISPLAY PACKAGED	1670#	EA	4.95 G
BY901	B901	ROTATES 360 BOLT THROUGH OR WELD ON BULK	2000#	EA	17.95 G



BY601



BY501



BY701



BY701S



BY703



BY705



BY8011



BY901

ERICKSON STAKE POCKET ANCHORS

PART #	MFG #	DESCRIPTION	MAX LOAD		
			RATING	UM	
EK09089	09089	STAINLESS STEEL POP UP FOR TRUCK STAKE POCKETS BULK		PR	27.85 G
EK4001	4001	STAKE POCKET ANCHOR RETRACTABLE DISPLAY PACKAGED	1000#	PR	30.95 G
EK01004	01004	STAKE POCKET ANCHOR ZINC DISPLAY PACKAGED		PR	12.95 G
EK51007	51007	STAKE POCKET TIE DOWN BULK		EA	5.95 G
EK01005	01005	STAKE POCKET ANCHOR CHROME DISPLAY PACKAGED		PR	16.55 G
EK51008	51008	STAKE POCKET TIE DOWN CHROME BULK		EA	8.35 G
EK9085	09085	COMBINATION STAKE POCKET ANCHOR PACKAGED	2000#	PR	17.95 G
EK1011	01011	TOGGLE STAKE POCKET ANCHOR CHROME DISPLAY PACKAGED		PR	15.95 G
EK51011	51011	TOGGLE STAKE POCKET ANCHOR CHROME BULK		EA	6.70 G



EK09089

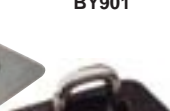

EK4001



EK01004



EK01005



EK9085

Buyers DOOR HOLDS

PART #	MFG #	DESCRIPTION	LENGTH	UM	
BY500	DH500SS	HOOK & KEEPER DOOR HOLDER STAINLESS STEEL	4"	KIT	6.95 H
BY2595	B2595LKB	SPRING LATCH WITH KEEPER 1/2" BOLT. BULK	4-1/2"	EA	7.95 J



BY500

TRAILER

ERICKSON SURFACE MOUNT WIRE RINGS

PART #	MFG #	DESCRIPTION	MAX LOAD RATING	UM		
EK9108	09108	SURFACE MOUNT WIRE RING PACKAGED	1200#	PR	5.20	G
EK59108	59108	SURFACE MOUNT WIRE RING BULK	1200#	EA	1.70	G
EK9111	09111	HEAVY DUTY SURFACE MOUNT RING PACKAGED	11,000#	EA	10.30	G
EK59111	59111	HEAVY DUTY SURFACE MOUNT RING BULK	11,000#	EA	8.90	G
EK59168	59168	WELD ON FLIP ANCHOR BULK 5/8"	15,000#	EA	11.95	G
EK59169	59169	WELD ON FLIP ANCHOR BULK 3/4"	20,000#	EA	15.95	G
EK9113	09113	4-BOLT SURFACE MOUNT RING PACKAGED	2000#	EA	4.35	G
EK59113	59113	4-BOLT SURFACE MOUNT RING BULK	2000#	EA	3.20	G

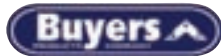

BUYERS SURFACE MOUNT WIRE RING



PART #	MFG #	DESCRIPTION	SAFE LOAD RATING	UM		
BY32	B32F	ZINC PLATED 3/8" DIA. FORGED ROPE RING DO NOT USE FOR LIFTING BULK	2000#	EA	4.95	G
BY28	B28F	HEAVY DUTY WELD ON ROPE RING BULK	1000#	EA	4.95	G
BY20	B20	SURFACE MOUNTED RING WITH FORGED STEEL CLAMP BULK	800#	EA	0.95	L
BY21	B21	SURFACE MOUNTED ROPE RING 1/4" BLACK ZINC BULK	800#	EA	1.95	H
BY23	B23SS	ROPE RING STAINLESS STEEL BULK	1000#	EA	2.95	G

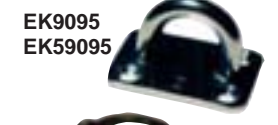
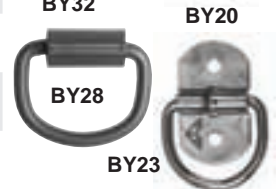

ERICKSON TIE DOWN ANCHORS

PART #	MFG #	DESCRIPTION	MAX LOAD RATING	UM		
EK9094	09094	HIDE-A-HOOK GASKETS & MOUNTING HARDWARE INCLUDED	1200#	PR	19.90	G
EK9099	09099	RUBBER COATED SLIDE ALONG PICK-UP RAIL DISPLAY PACKAGED		PR	18.25	G
EK9095	09095	STAINLESS STEEL ANCHOR DISPLAY PACKAGED	1200#	EA	13.25	G
EK59095	59095	STAINLESS STEEL ANCHOR BULK	1200#	EA	6.00	G
EK9112	09112	SCREW IN ANCHOR RING DISPLAY PACKAGED	1200#	EA	4.10	G
EK9090	09090	HORSE SHOE ROPE CLEAT ZINC PLATED PACKAGED		PR	13.90	G
EK9091	09091	SWING OUT HOOKS SPRING LOADED SCREWS INC		PR	5.90	G

TIE DOWN THREADED LINKS

PART #	MFG #	DESCRIPTION	SIZE	UM		
LR50646	50646	QUICK CONNECTION ZINC FINISH TIGHTENS W/ FINGERS PACKAGED	3/16"	PR	3.90	G
LR50647	50647	QUICK CONNECTION ZINC FINISH TIGHTENS W/ FINGERS PACKAGED	1/4"	PR	4.62	G
LR50648	50648	QUICK CONNECTION ZINC FINISH TIGHTENS W/ FINGERS PACKAGED	5/16"	EA	3.15	G
LR50649	50649	QUICK CONNECTION ZINC FINISH TIGHTENS W/ FINGERS PACKAGED	3/8"	EA	4.57	G

ERICKSON O-TRACK

PART #	MFG #	DESCRIPTION	UM		
EK09133	09133	O-TRACK W/2 CLIP RINGS - 18" VERTICAL CLAM SHELL PACKAGING	EA	30.00	G

- 18" Length
- With 2 movable rings
- Aluminum design
- Extra rings available

Erickson's O-Track is available in 18" length with two moveable anchor rings. This unique aluminum design enables the user to mount multiple pieces end to end and as long as desired. The patented spring-loaded lock clip simply moves to whatever hole you need. Approved by the airline industry. Ideal for vertical or horizontal applications, trailers, pickup trucks, cargo vans, SUVs, etc.



2-PACK REPLACEMENT ANCHOR RINGS

Display Packaged
EK09132 7.40 G

EK59132 ea (bulk) 3.35 G

- tires & wheels
- axles, hubs & springs
- tongue accessories
- hitches
- electrical
- brake parts
- trailer hardware
- locks & pins
- towing & loading
- tie downs
- tools
- chemicals

TRAILER

TRAILER HARDWARE

Buyers QUICK LINK CONNECTOR

PART #	MFG #	DESCRIPTION	SIZE	UM		
BY0038	7350038	BUYERS QUICK LINK CONNECTOR ZINC PLATED BULK	3/8"	EA	4.95	G



Buyers HOOD CATCHES

PART #	MFG #	DESCRIPTION				
BY195	WJ195	4" EASY GRIP WITH BRACKET*			3.95	G
218000	WJ201A	4-7/8" RUBBER HOOD CATCH WITH "A" BRACKET			3.95	G
218001	WJ201H	4-7/8" RUBBER HOOD CATCH WITH BLACK "A" BRACKET			4.95	G
218002	WJ201SS	4-7/8" RUBBER HOOD CATCH WITH "A" BRACKET STAINLESS STEEL BRACKET			5.95	G
BY201	WJ201U	4-7/8" RUBBER HOOD CATCH			3.95	H
BY202	WJ202	2 1/2" EASY GRIP WITH BRACKET			2.95	G
BY205	WJ205	6" RUBBER HOOD CATCH			5.95	G
218003	WJ205RO	6" HEAVY DUTY RUBBER HOOD CATCH HANDLE ONLY NO BUMPER			5.95	G
218004	WJ206	6" HEAVY DUTY RUBBER HOOD CATCH INCLUDES BRACKETS AND PINS			5.95	G
218005	WJ206RO	6" HEAVY DUTY RUBBER HOOD CATCH HANDLE ONLY			5.95	G
218006	WJ208	7-7/8" HEAVY DUTY RUBBER HOOD CATCH INCLUDES BRACKETS AND PIN			7.95	G
218007	WJ208RO	7-7/8" HEAVY DUTY RUBBER HOOD CATCH HANDLE ONLY			6.95	G
218008	WJ211	12" ULTRA RUBBER/POLYMER HOOD CATCH**			17.95	G
218009	WJ212	9" RUBBER/POLYMER DRAW LATCH***			18.95	G
218010	WJ213	13-1/4" RUBBER/POLYMER DRAW LATCH****			19.95	G
218011	WJ215	4-1/4" RUBBER/POLYMER DRAW LATCH			5.95	G
BY960	WJ96WCB	HOOD CATCH WITH KEEPER & HARDWARE			3.95	J

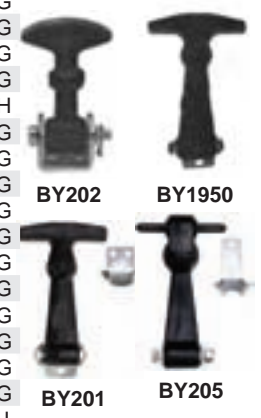

*COMPARES TO SOUTHCO PART NO. 37-10-086-10 **COMPARES TO STANDARD NAVISTAR HOOD CATCH
 COMPARES TO SOUTHCO PART NO. 37-30-294-60 *COMPARES TO SOUTHCO PART NO. 37-140-295-60

Buyers DRAW LATCHES

PART #	MFG #	DESCRIPTION				
BY225	WJ225	HEAVY DUTY ADJUSTABLE DRAW LATCH ZINC PLATED STEEL BULK	EA	7.95	H	
BY207	BHC207Z	PADLOCK EYE PULL-DOWN CATCH WITH STRIKER ZINC PLATED STEEL. BULK	EA	3.95	G	
BY227	BHC227Z	LARGE PADLOCK EYE PULL-DOWN CATCH WITH STRIKER ZINC - PLATED STEEL. BULK	EA	1.95	H	
BY801	BHC801Z	PULL DOWN CATCH - HOOK STYLE ZINC PLATED STEEL. BULK	EA	2.95	G	



Buyers HANDLES

PART #	MFG #	DESCRIPTION	LENGTH	UM		
BY2399	B2399B2C	DIE CAST GRAB HANDLE BULK	8-1/4"	EA	9.95	G
BY2344	B2344	CHEST HANDLE ZINC PLATED BULK	4"	EA	2.95	G



Buyers HINGE

PART #	MFG #	DESCRIPTION	LENGTH	UM		
BY40	SH40	HEAVY-DUTY HINGED SECURITY HASP BULK	4-1/4"	EA	4.95	G
BYA23	A23	CONTINUOUS HINGE ALUMINUM EQUAL LEAVES FULL HARD ALUMINUM PINS	72"	EA	15.95	G
BY2158	B2159C	CAM ACTION DOOR LOCK KIT. CAST STEEL CUPS, STEEL HANDLE, AND SUPPORTS 3/4" PIPE NOT INCL		KIT	24.95	G
BY2423	B2423H	STRAP HINGE 16"	16"	EA	26.95	G
BY2424	B2424SS	STAINLESS STEEL STRAP HINGE	3-5/8"	EA	7.95	H

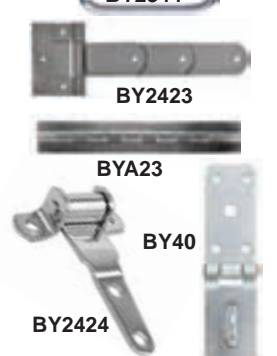

Buyers 3/8" BED ANCHOR

PART #	MFG #	DESCRIPTION	SAFE LOAD RATING	UM		
BY0375	5500375	3/8" BED ANCHOR, REMOVABLE EYEBOLT ZINC PLATED - RETAIL PACKAGED	400#	PR	14.55	G



ERICKSON CARGO BARS

PART #	MFG #	DESCRIPTION	UM			
EK8906	08906	CARGO BAR LEVER ACTION 88" - 103"	EA	42.45	B	
EK8907	08907	CARGO BAR LEVER ACTION 60" - 75"	EA	39.95	B	
EK8909	08909	CARGO BAR RATCHETING - 81-105"	EA	119.95	B	



81"-105" EK8909

TRAILER

- tires & wheels
- axles, hubs & springs
- tongue accessories
- hitches
- electrical
- brake parts
- trailer hardware
- locks & pins
- towing & loading
- tie downs
- tools
- chemicals

Buyers STAKE BODY COMPONENTS

PART #	MFG #	DESCRIPTION	LENGTH	UM	
BY2585	B2585BZ	RACK CONNECTOR STRAIGHT - ZINC 4PC		SET	10.95 H
BY2591	B2591BZ	RACK CONNECTOR CORNER - ZINC 4PC		SET	10.95 H
BY2588	B2588BZ	SECURITY LATCH STRAIGHT 4PC		SET	8.95 G
BY2589	B2589BZ	SECURITY LATCH - CORNER 4PC		SET	8.95 G
BY1454	SA1454WDNH	STAKE ASSEMBLY 14 GAUGE STEEL	54"	EA	31.95 G
BY166548	LS166548	LINER SLAT 6-1/2" WIDE ROLLED STEEL	47.25"	EA	26.95 G
BY25901	B2590LH	STAKE BODY SPRING LATCH L.H 1/2" ASSEMBLY		EA	8.95 G
BY25903	B2590RH	STAKE BODY SPRING LATCH R.H 1/2" ASSEMBLY		EA	8.95 G
BY25905	B2590KZ	90° KEEPER FOR SPRING LATCH		EA	2.95 G



BY2591



BY2588



BY2589



BY25901
BY25903



BY25903
BY25905



235004

Buyers STAKE POCKETS

PART #	MFG #	DESCRIPTION	DEPTH	UM	
BY2373W	B2373W	STRAIGHT WELD ON STAKE POCKETS. BULK INSIDE DIMENSIONS 3" X 1-1/2"	2-1/2"	EA	3.95 H
BY2373R	B2373R	STRAIGHT WELD ON STAKE POCKETS. BULK INSIDE DIMENSIONS 3-1/2" X 1-1/2"	3"	EA	3.95 H
BY2373G	B2373G	STRAIGHT BOLT ON STAKE POCKETS. BULK INSIDE DIMENSIONS 3" X 1-1/2"	2-1/2"	EA	2.95 G
BY2374G	B2374G	TAPERED BOLT ON STAKE POCKETS. BULK. INSIDE DIMENSION 3"X1-1/2" TOP 2-7/8"X1-1/2" BOTTOM	2-1/2"	EA	2.95 G

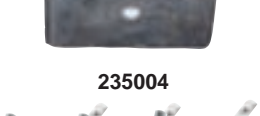
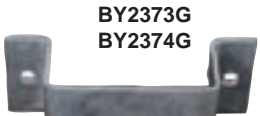

SMITH STAKE POCKET

PART #	DESCRIPTION	DEPTH	UM	
235004	BOLT ON STAKE POCKET HOLDS 2"X4" 5/8" BOLT HOLE	2"	EA	6.65 G

ERICKSON TIE HOOKS

PART #	MFG #	DESCRIPTION	UM	
EK9092	09092	TIE HOOK - ZINC (PKG 4) DISPLAY PACKAGE	PKG	6.40 G



ERICKSON BRASS SWIVEL HOOKS

PART #	MFG #	DESCRIPTION	UM	
EK4014	04014	BRASS SWIVEL HOOKS 4-5/8" X 7/8" PACKAGED	EA	6.50 G



Buyers OPEN EYE SNAP HOOK

PART #	MFG #	DESCRIPTION	LENGTH	UM	
BY600	B600B	OPEN EYE SNAP HOOK 1/4" CHAIN BULK	3-5/16"	EA	2.55 J



SMITH 'S' HOOKS

PART #	DESCRIPTION	LOAD RATING	UM	
CS16640	FOR TRAILER SAFETY CHAIN CLASS I BULK	2000#	EA	1.20 L
CS16642	FOR TRAILER SAFETY CHAIN CLASS III BULK	5000#	EA	1.75 L



Buyers ANCHOR SHACKLES

PART #	MFG #	DESCRIPTION	LOAD RATING	UM	
BY80375	5480375	GALVANIZED ANCHOR SHACKLE 3/8" BULK	1TON	EA	2.95 G



Buyers SLING HOOK

PART #	MFG #	DESCRIPTION	LOAD RANGE	UM	
BY0058	WSL0058	WELD LESS SLING HOOK 5/8" STEEL BULK	4200#	EA	4.50 B



- tires & wheels
- axles, hubs & springs
- tongue accessories
- hitches
- electrical
- brake parts
- trailer hardware
- locks & pins
- towing & loading
- tie downs
- tools
- chemicals

TRAILER

TRAILER HARDWARE

- tires & wheels
- axles, hubs & springs
- tongue accessories
- hitches
- electrical
- brake parts
- trailer hardware
- locks & pins
- towing & loading
- tie downs
- tools
- chemicals

ERICKSON E-TRACKS

PART #	MFG #	DESCRIPTION	UM		
EK19135	19135	E-TRACK HORIZONTAL 8FT BULK	EA	36.75	G
EK9146	19146	E-TRACK VERTICAL - 4FT BULK	EA	16.95	G



EK19135
EK9146

Buyers E-TRACKS

PART #	MFG #	DESCRIPTION	UM		
EK9148	1903055	E-TRACK HORIZONTAL 5' BULK	EA	17.95	G
EK9150	1903052	E-TRACK HORIZONTAL - 2' BULK	EA	7.95	G

EK9148
EK9150

ERICKSON TIE OFF RING

PART #	MFG #	DESCRIPTION	LOAD RANGE	UM		
EK9143	09143	E-TRACK TIE OFF RING 2" X 8" BULK	3500#	EA	8.65	G
EK9131	59131	E-TRACK TIE OFF RING BULK	4000#	EA	5.65	G
EK9147	59147	E-TRACK TIE OFF RING BULK	6000#	EA	8.40	G



EK9131



EK9147



EK91090

Buyers TIE OFF RING

PART #	MFG #	DESCRIPTION	LOAD RANGE	UM		
BY01090	01090	E-TRACK TIE OFF RING BULK	6000#	EA	3.95	G

ERICKSON E-TRACK STRAPS

PART #	MFG #	DESCRIPTION	LOAD RANGE	UM		
EK9137	09137	E-TRACK RATCHETING LOGISTIC STRAP - 2" X 16FT PACKAGED	3500#	EA	26.90	G
EK9151	09151	E-TRACK CAM LOCK LOGISTIC STRAP - 2" X 10FT PACKAGED		EA	19.95	G



EK9151



EK9135
EK9137

ERICKSON E-TRACK WOOD BEAM SOCKET

PART #	MFG #	DESCRIPTION	UM		
EK9149	59149	WOOD BEAM SOCKET HOLDS 2X4 & 2X6 BULK	EA	7.45	G



BY01100

Buyers WOOD BEAM SOCKET

PART #	MFG #	DESCRIPTION	UM		
BY01100	01100	BUYERS E-TRACK WOOD BEAM SOCKET	EA	4.95	H

ERICKSON TRAILER STRAPS

PART #	MFG #	DESCRIPTION	LOAD RATING	UM		
EK2300	02300	RATCHET STRAP 2" X 15' DOUBLE "J" HOOKS PACKAGED	5000#	EA	29.20	G
EK2400	02400	RATCHET STRAP 2" X 25' DOUBLE "J" HOOKS PACKAGED	5000#	EA	34.75	G
EK68655	68655	2"X27' RATCHET STRAP CAMO BULK	10,000#	EA	33.25	G



EK2300
EK2400

EK68655

ERICKSON TOW POINTS

PART #	MFG #	DESCRIPTION	LOAD RATING	UM		
EK9509	09509	ERICKSON'S TOW HOOK - CHROME	10,000#	EA	18.95	G
EK9510	09510	ERICKSON'S TOW HOOK - BLACK POWDER COATED	10,000#	EA	16.95	G
EK57500	57500	HITCH RECEIVER SWIVEL CLEVIS		EA	49.95	G



EK9509

EK9510



EK57500

TRAILER

SNIP & PINS



LOCKS & PINS

- tires & wheels
- axles, hubs & springs
- tongue accessories
- hitches
- electrical
- brake parts
- trailer hardware
- locks & pins
- towing & loading
- tie downs
- tools
- chemicals



Dare To Compare! TRIMAX, The Absolute Leader in Receiver Locking Pin Technology. TRIMAX has spent the last 15 years expanding and improving on the "Original", patented Dual Lock Lug Design. **LOOK ALIKES DO NOT LOCK ALIKE!!**
BUY ONLY TRIMAX BRANDED PARTS.

- No internal springs to seize up or break
- Keyed-alike sets available for adjustable hitches
- Ideal for securing hitch receivers, bike carriers, ornamental receiver plugs and swing away trailer hitches
- Unmatched durability and corrosion protection

What makes all Trimax Locking Pins the Strongest You Can Buy?



RECEIVER LOCKING PIN



348055

PART #	MFG #	DESCRIPTION	UM
TX3001	T2	Machine Forged Chrome Steel, 1/2" x 2-3/4" Span	EA 22.95 G
TX3008	T3	Machine Forged Chrome Steel, 5/8" x 2-3/4" Span	EA 22.95 G
348012	T5	Machine Forged Chrome Steel, 5/8" x 3-1/2" Span Fits Class V Hitches	EA 24.95 L
348053	TH4	Machine Forged Chrome Steel, Adjustable Hitch Lock, 5/8" x 4-3/8" Span	EA 28.95 L
348054	TH6	Machine Forged Chrome Steel, 5/8" x 6-1/8" Span, Swing Away Trailer Lock	EA 29.95 L
348055	TH43	"Rapid Hitch" Keyed-Alike Adjustable Receiver Lock Set	EA 51.95 L

EPOXY POWDER COATED LOCKING PIN



TX3002

PART #	MFG #	DESCRIPTION	UM
TX3002	T3-Black	Premium 5/8" Key Receiver Lock Rugged Black Epoxy Powder Coat	EA 23.95 G

100% STAINLESS STEEL LOCKING PIN



348056

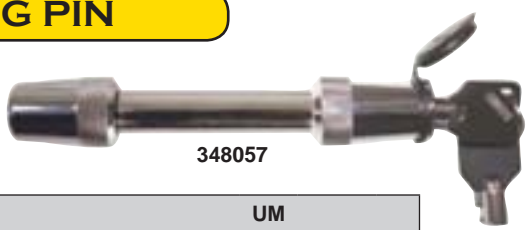

348057

PART #	MFG #	DESCRIPTION	UM
348056	SXT3	Premium 100% Stainless Steel 5/8" Key Receiver Lock	EA 30.95 L
348057	SXT5	Premium 100% Stainless Steel 5/8" Key Receiver Lock, 3-1/2" Span	EA 33.95 L

TRAILER



"Lock It Or Lost It"

- tires & wheels
- axles, hubs & springs
- tongue accessories
- hitches
- electrical
- brake parts
- trailer hardware
- locks & pins
- towing & loading
- tie downs
- tools
- chemicals

ANTI RATTLE RECEIVER PIN



- Easily Adjust Receiver Pin for Tight Fit
- Includes 2 Rugged Keys

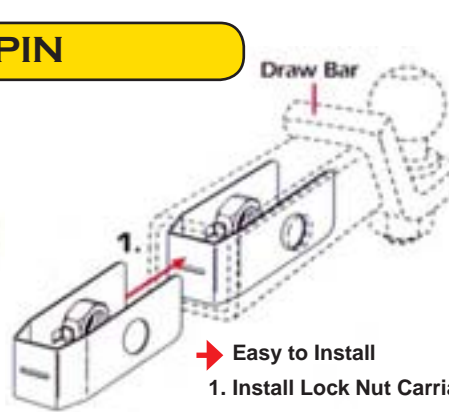

→ Easy to Install

1. Install Lock Nut Carriage into Draw Bar, Align with Holes
2. Slide Draw Bar into Receiver, Insert Lock Pin & Tighten
3. Insert 5/8" Head & Attach Lock Head



PART #	MFG #	DESCRIPTION	UM
348058	TAR300	Premium 5/8" Wobble Key Receiver Lock	EA 32.95 L

UNIVERSAL FIT LOCKING PIN

→ Convert from 1/2" to 5/8"

1. Remove Lock Head
2. Slide 5/8" Stainless Steel Sleeve onto Pin Shaft
3. Install in Receiver & Replace Lock Head



PART #	MFG #	DESCRIPTION	UM
348015	TS32	Universal Receiver Lock - Fits 1/2" & 5/8" w/Sleeve	EA 23.95 L
348016	SXTS32	100% Stainless Steel Universal Receiver Lock - Fits 1/2" & 5/8" w/ Stainless Steel Sleeve	EA 32.95 L

TS2000

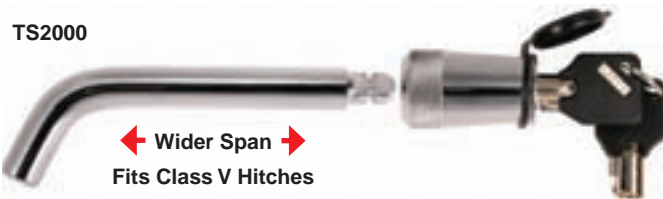

← Wider Span →
Fits Class V Hitches

TX1998



1/2" Pin fits all Class II Receiver Hitches

PART #	MFG #	DESCRIPTION	UM
TX2000	TR200	Deluxe 5/8" Key Receiver Lock, 3-1/2" Span	EA 19.99 G
TX1998	TR125	Deluxe 1/2" Key Receiver Lock, Fits 1-1/4" Class II Receivers	EA 19.95 G



RESETTABLE COMBINATION LOCKING PIN

Durable Non-Corrosive Locking Mechanism



Easy To Read Numbers

Forged Steel Lock Tip

→ Heavy Duty Collar Overlaps Hitch Pin For Unmatched Strength & Security

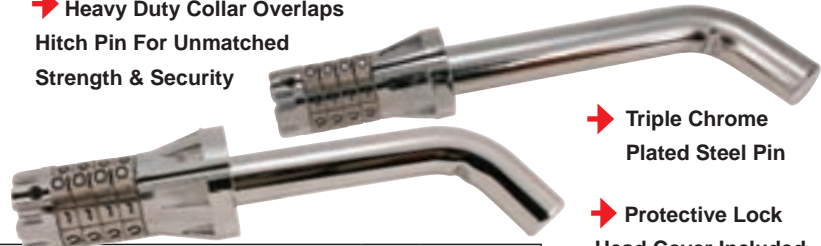

→ Triple Chrome Plated Steel Pin

→ Protective Lock Head Cover Included

PART #	MFG #	DESCRIPTION	UM
348014	MAG200	Resettable Combination Receiver Bent Pin Lock 5/8"	EA 23.95 L
348013	MAG125	Resettable Combination Receiver Bent Pin Lock 1/28"	EA 32.95 L

Set Your Own Personalized Combination

TRAILER

LOCKS & PINS

- tires & wheels
- axles, hubs & springs
- tongue accessories
- hitches
- electrical
- brake parts
- trailer hardware
- locks & pins
- towing & loading
- tie downs
- tools
- chemicals



"Lock It Or Lost It"

"FLIP-TIP" PINS

Easy to Install

1. Squeeze Tip & Push Down Head
2. Rotate Tip Forward for Insertion into or Removal from Receiver
3. Once Pin is Through Receiver Hole, Rotate Tip Downward Until Tip "SNAPS" Firmly into Place.



Triple Chrome Plated or Premium Stainless Steel

→ 1/2" Pin Fits all Class I & II Receivers

→ 5/8" Pin Fits all Class III, IV & V Receivers

PART #	MFG #	DESCRIPTION	UM
348017	TX125	Chrome Plated "FLIP-TIP" 1/2" Receiver Pin & Clip	EA 8.95 L
348018	TX200	Chrome Plated "FLIP-TIP" 5/8" Receiver Pin & Clip	EA 8.95 L
TX1255	SCTX125	Premium Stainless Steel "FLIP-TIP" 1/2" Receiver Pin & Clip	EA 10.95 G
TX2005	SCTX200	Premium Stainless Steel "FLIP-TIP" 5/8" Receiver Pin & Clip	EA 10.95 G

PIN & CLIPS

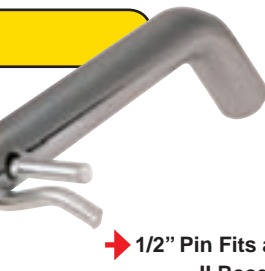

→ 1/2" Pin Fits all Class I & II Receivers

→ 5/8" Pin Fits all Class III, IV & V Receivers



Triple Chrome Plated

TX1258
TX2010

PART #	MFG #	DESCRIPTION	UM
TX1258	SP125	Steel Pin & Clip 1/2" Receiver Pin	EA 5.95 G
TX2010	SP200	Steel Pin & Clip 5/8" Receiver Pin	EA 5.99 G

TRAILER

MULTI-USE COUPLER TRIGGER

Great for Trailer Door Latches & Cargo Boxes



Available in Both Flat & Round Keys

→ Easy 1/4 Turn of Key to Lock & Unlock for Maximum Security

→ Internal O-Ring in Lock Body & Weather Proof Cap help Seal out Grime and Corrosion



PART #	MFG #	DESCRIPTION	UM
348019	TMC10	Deluxe Coupler/Door Latch Lock - Fits Couplers w/up to 7/8" Span	EA 49.95 L



"Lock It Or Lost It"

MACHINE HARDENED STEEL LOCKING PINS

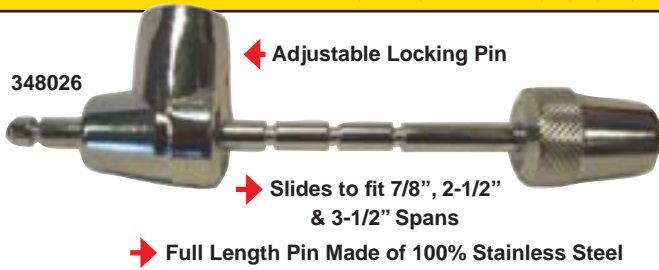

PART #	MFG #	DESCRIPTION	UM
348023	TC1	Coupler/Door Latch Lock Fits Couplers w/up to 7/8" Span	EA 15.95 L
348024	TC2	Coupler Lock Fits Couplers w/up to 2-1/2" Span	EA 16.95 L
348025	TC3	Coupler Lock Fits Couplers w/up to 3-1/2" Span	EA 16.95 L
348026	TC123	Adjustable Coupler Lock Fits Couplers from 7/8", 2-1/2" to 3-1/2" Spans	EA 17.95 L



KEYED ALIKE SETS

PART #	MFG #	DESCRIPTION	UM
348027	TM31	TX3008 - 5/8" Receiver Lock & 348023 - 7/8" Span Coupler Lock	SET 39.95 L
348028	TM32	TX3008 - 5/8" Receiver Lock & 348024 - 2-1/2" Span Coupler Lock	SET 39.95 L
348029	TM33	TX3008 - 5/8" Receiver Lock & 348025 - 3-1/2" Span Coupler Lock	SET 39.95 L
348030	TM3123	348015 - Universal Fit Locking Pin & 348026 Adjustable Coupler Lock	SET 39.95 L

100% STAINLESS STEEL LOCKING PINS

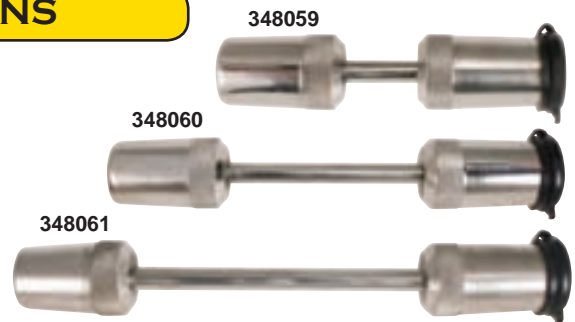

PART #	MFG #	DESCRIPTION	UM
348059	SXTC1	Premium Stainless Steel Coupler//Door Latch Lock Fits Couplers 7/8" Span	EA 26.95 L
348060	SXTC2	Premium Stainless Steel Coupler Lock Fits Couplers w/up to 2-1/2" Span	EA 27.95 L
348061	SXTC3	Premium Stainless Steel Coupler Lock Fits Couplers w/up to 3-1/2" Span	EA 27.95 L
348062	SXTC123	Adjustable Stainless Steel Coupler Lock Fits 7/8", 2-1/2" to 3-1/2" Spans	EA 26.95 L



STAINLESS STEEL KEYED ALIKE SETS

PART #	MFG #	DESCRIPTION	UM
348063	SXTM31	Stainless Steel 348056 - 5/8" Receiver Lock & 348059 - 7/8" Span Coupler Lock	SET 39.95 L
348064	SXTM32	Stainless Steel 348056 - 5/8" Receiver Lock & 348060 - 2-1/2" Span Coupler Lock	SET 39.95 L
348065	SXTM33	Stainless Steel 348056 - 5/8" Receiver Lock & 348061 - 3-1/2" Span Coupler Lock	SET 39.95 L
348066	SXTM3123	Stainless Steel 348016 - Universal Fit Locking Pin & 348062 Adjustable Coupler Lock	SET 39.95 L



- tires & wheels
- axles, hubs & springs
- tongue accessories
- hitches
- electrical
- brake parts
- trailer hardware
- locks & pins
- towing & loading
- tie downs
- tools
- chemicals

TRAILER

- tires & wheels
- axles, hubs & springs
- tongue accessories
- hitches
- electrical
- brake parts
- trailer hardware
- locks & pins**
- towing & loading
- tie downs
- tools
- chemicals



"Lock It Or Lost It"

UNIVERSAL COUPLER LOCKS



348019



➔ Patented Dual Lock System



TX1005

PART #	MFG #	DESCRIPTION	UM
348019	UMAX50	Universal "Die-Cast" Dual Purpose Coupler (Fits Most Couplers)	EA 49.95 L
TX1005	UMAX100	Premium Universal 360° of "Solid Hardened Steel" Dual Purpose Coupler Lock (Fits Most Couplers)	EA 79.95 G



KEYED ALIKE KITS

- ➔ Ultimate Protection for Work & Play
- ➔ Includes Carrying Case
- ➔ 3 Locks - 1 Key!



348020



348021

PART #	MFG #	DESCRIPTION	UM
348020	TCP100	Combo Pack Keyed Alike Set, Includes TX1005, 348026 - Adjustable Coupler Lock Fits Couplers from 7/8", 2-1/2" to 3-1/2" Spans, 348015 - 5/8" or 1/2" Universal Receiver Lock	EA 119.95 L
348021	TCP50	Combo Pack Keyed Alike Set, Includes 348019, 348026 - Adjustable Coupler Lock Fits Couplers from 7/8", 2-1/2" to 3-1/2" Spans, 348015 - 5/8" or 1/2" Universal Receiver Lock	EA 89.95 L

TRAILER



MAX Security for ALL Applications!

LUNETTE LOCK



Lunette Tow Ring Security Lock
MAX Security for Unattended Pintle Hook Trailers

- Made from Heavy Duty Weather Resistant Metal Alloy
- Fits 2-7/8" Inside Diameter
- Easy to Install
- Includes 2 Rugged Keys

PART #	DESCRIPTION	UM
348032	Lunette Two Ring Lock 2-7/8 " Inside Diameter	69.95 L

5TH WHEEL LOCK



MAX Security for Unattended 5th Wheel Trailers

- Constructed of Heavy Gauge Alloy for Added Security
- Rugged Weather Proof Epoxy Powder Coat Finish prevents Rust
- Easy to Install - Unlock TFWSS, lock head will spring out from the lock. Slide lock up to cover hitch. Push in lock head and turn key
- Includes 3 Rugged Keys

PART #	MFG #	DESCRIPTION	UM
348033	TFW55	5th Wheel Trailer Lock	EA 49.95 L

ULTRA -MAX WHEEL LOCKS



- Heavy Gauge Steel Disc Covers Lug Nuts to Prevent Tire Removal
- Clamps Tight to Wheel for Added Security
- Fits Almost all 10" - 18" Wheels

PART #	MFG #	DESCRIPTION	UM
TX0100	TWL100	Adjustable Wheel Lock - Fits Nearly All 10" - 18" Wheels	EA 259.95 B

"Chock It & Lock It"

- Quick & Easy Installation for Unattended Trailers, Construction Equipment, Cars, Boats, ATV'S & More
- Rubber Coated Arms to Protect Wheel Finish
- High Strength Pick Resistant Locking Mechanism with Cover to Help Keep Out Dirt and Grime

PART #	MFG #	DESCRIPTION	UM
TX0175	TWL75	Universal "Die-Cast" Dual Purpose Coupler (Fits Most Couplers)	EA 94.95 E

WALL FLOOR ANCHOR



Ideal for Securing Lawn Furniture, Bicycles, Tools, Motorcycles & More. Mounts Anywhere! Use with TRIMAX Cables & Chains

348067	36.95	L
--------	-------	---

WATERCRAFT LOCKS

PART #	MFG #	DESCRIPTION	UM
348009	T6	TRIMAX WATERCRAFT LOCKING PIN 5-1/2" X 1/2"	EA 29.95 L
348010	TBL610	OUTBOARD MOTOR LOCK	EA 28.95 L





"The World's Toughest Locks™"

- tires & wheels
- axles, hubs & springs
- tongue accessories
- hitches
- electrical
- brake parts
- trailer hardware
- locks & pins
- towing & loading
- tie downs
- tools
- chemicals

IRON CLAD ARMOR PLATED LOCKS

- All are ballistic grade covered with durable PVC skin to prevent scratching
- Ideal for bicycles, motorcycles, spare tire, trailer, marine and more
- All come with 3 ultra secure "Wise Keys"
- One key is a mini flashlight
- Flexible for easy transport
- Display packaged



TX2236 24.95 G 36" x 22mm	TX3048 33.95 G 48" x 26mm	TX3072 48.95 G 72" x 26mm
----------------------------------	----------------------------------	----------------------------------

BRAIDED & COILED QUADRA-BRAID™ LOCK

- Armor plated
- Repels saw cuts and bolt cutters
- Comes with: 3 keys - one with a mini flashlight



TX1532 15.95 G 32" x 15mm

TRIMAFLEX™ DUAL LOOPED CABLE

- Exclusive MAX security quadra braid multi-use cables
- For maximum protection use with **TX6000** and **TX4004** for the ultimate in multi-use security



TX8150 17.99 G 8' x 15mm



TX1212 17.99 G 12' x 12mm



TX1510 16.95 G 15' x 10mm



TX3010 29.99 G 30' x 10mm

MAX-DUAL FORCE U-CABLE LOCK

- Multi use combined cable and u-lock system - the best of both worlds
- The security of a mini u-lock combined with the versatility of a cable
- Max dual force lock system features exclusive Trimaflex™ quadra braid cable for maximum theft prevention



TX1572 22.95 G 72" x 15mm

MULTI-PURPOSE SPARE TIRE LOCK

- The only spare tire lock that secures both spare tire and tire bracket to welded frame member!
- Locks through wheel lug nut hole for maximum security
- Ideal for securing spare tires on: boat trailers, jeeps, trucks, and vans



TX3000 19.99 G 36" x 12mm

QUADRA-BRAID™ LOCK

- Integrated keyed cable locks with quick release bracket
- Ballistic grade polymer lock housing for durability
- Display packaged



TX3600 19.95 G 6' x 12mm

COMBINATION CABLE LOCK

- A multi-use resettable combination cable lock featuring an exclusive TRIMAFLEX ultra tough braided cable (10 feet long x 8mm diameter) and a combination lock head
- Ideal for securing bikes, bike carriers, watercraft on the beach, trailers and much, much more



348000 18.95 L 10' x 8mm





MAX Security for ALL Applications!

3' X 10 MM ALARM LOCK AND THEX SUPER CHAIN



- Alarm locking mechanism sets off 110 decibel ear piercing scream when moved or tampered with
- Withstands 6 tons of pulling force and 11 tons of cutting force
- Durable nylon sleeve protects against scratches

348037 83.95 L

INTEGRATED LOCK & SUPER CHAIN - 6MM LINKS X 36" LENGTH



- Large hexagon shaped 6 mm links
- High strength combination chain lock
- No keys to break or lose
- Anti-drill and pick resistant lock mechanism

348034 33.95 L

4' X 25 MM ALARM LOCK AND QUADRA-BRAID CABLE



- Alarm locking mechanism sets off 110 decibel ear piercing scream when moved or tampered with
- Withstands 6 tons of pulling force and 11 tons of cutting force
- Features exclusive 25 millimeter TRIMAFLEX Quadra-braid cable for max security

348038 83.95 L

INTEGRATED LOCK & SUPER CHAIN - 8MM LINKS X 36" LENGTH



- Large hexagon shaped 8 mm links
- Durable NYLOMEX sleeve protects against scratches
- Ballistic grade polymer lock housing cover resists hammer strikes and protects lock mechanism
- Patented key cover resists grime and moisture
- Withstands over 6 tons of pull force and 11 tons of cutting force

348035 33.95 L

6' X 25 MM ALARM LOCK AND QUADRA-BRAID CABLE



- Alarm locking mechanism sets off 110 decibel ear piercing scream when moved or tampered with
- Withstands 6 tons of pulling force and 11 tons of cutting force
- Features exclusive 25 millimeter TRIMAFLEX Quadra-braid cable for max security

348039 92.95 L

INTEGRATED LOCK & SUPER CHAIN - 10MM LINKS X 36" LENGTH



- Large hexagon shaped 10 mm links
- Durable NYLOMEX sleeve protects against scratches
- Ballistic grade polymer lock housing cover resists hammer strikes and protects lock mechanism
- Patented key cover resists grime and moisture
- Withstands over 6 tons of pull force and 11 tons of cutting force

348036 39.95 L

HIGH SECURITY GENERAL PURPOSE CABLE U-LOCKS - MAX 60

- Chrome shackle
- Use on motorcycle discs & looped cables
- The strongest short shackle locks you can buy
- Display packaged

PART #	DESCRIPTION
TX4004 22.95 G	Max 40, Yellow
TX4002 22.95 G	Max 40, Black



tires & wheels
axles, hubs & springs
tongue accessories
hitches
electrical
brake parts
trailer hardware
locks & pins
towing & loading
tie downs
tools
chemicals

TRAILER



"The World's Toughest Locks™"

- tires & wheels
- axles, hubs & springs
- tongue accessories
- hitches
- electrical
- brake parts
- trailer hardware
- locks & pins
- towing & loading
- tie downs
- tools
- chemicals

MULTI-USE VERSA-CABLE LOCK 6' X 10MM TRIMAFLEX CABLE

- 6" vinyl coated steel cable (lock not included)
- Quick installation
- Ideal for securing and locking: bike racks, jet skis, motorcycles, and furniture
- Retail packaged
- 12' and 30' replacement cables sold separately, see below



TX1006 26.95 G 6' x 10mm

MULTI-USE VERSA-CABLE CAMO LOCK 9' X 10MM TRIMAFLEX CABLE

- 9" vinyl coated steel cable (lock not included)
- Quick installation
- Ideal for securing and locking: bike racks, jet skis, motorcycles, and furniture
- Retail packaged
- 12' and 30' replacement cables sold separately, see below



Recommended Uses:

- Bicycles
- Power Tools
- Patio Furniture
- BBQ Grills
- Sports Equipment
- Fire Arms
- Power Sports
- Marine Tpoys - Wakeboards, Towables, Jet Skis, Coolers & More!

348040 29.95 L 9' x 10mm

REPLACEMENT CABLES FOR MULTI-USE CABLE LOCK, SEE ABOVE

- Replacement cable for above multi-use cable lock
- 12' or 30' long x 10mm

**TX1012 →
24.99 E
12' L x 10mm**



**TX1030 →
29.99 E
30' L x 10mm**



HIGH SECURITY 14MM SHACKLE LOCKS

- High security for your bicycle or ATV
- Mounting bracket included
- Made of high strength hardened steel
- Heavy duty anti-pick lock head
- Includes 3 keys, one equipped with a mini flashlight
- Key hole cover keeps out dirt and grime
- 2 choices
- Retail packaged



**TX6010 27.95 H
4-1/8" x 8"
w/14mm shackle**



**TX6020 26.95 H
4-1/8" x 11"
w/14mm shackle**

WEATHER PROOF PADLOCK

- Rugged weather resistant PVC housing covers laminated solid brass lock body
- Dual locking 1-1/8" x 5/16" DIA hardened shackle



TX1125 7.99 G

KEYED ALIKE LOCKS

- 3 per package keyed alike locks
- Rugged weather resistant PVC housing covers laminated solid brass lock body
- Dual locking 1-1/8" x 5/16" DIA hardened shackle



TX3125 17.99 G

TRAILER



MAX Security for ALL Applications!

HIGH SECURITY SHIELDED PADLOCKS

- Ideal for locking enclosed trailers
- Stainless steel, 70mm padlock, 10mm hardened shackle, and exclusive armor plated key core for added security



TX1700 13.99 G



3 PACK KEYED ALIKE HIGH SECURITY SHIELDED PADLOCKS

- 3 pack keyed alike set of TX1700 round disc pad lock 70mm

348008 39.95 L



MAXIMUM SECURITY PADLOCKS IDEAL FOR LOCKING ENCLOSED TRAILERS



51mm hardened solid chrome steel padlock, with 1.25" x 10mm shackle, commercial grade

TX1705 14.95 G



51mm hardened solid chrome steel padlock, with 2.25" x 10mm shackle, commercial grade and re-keyable

TX2750 14.95 G

4 PACK KEYED ALIKE LOCKS



- 4-pack keyed alike TX1000 padlocks
- Dual locking laminated padlock
- 40 mm solid steel construction
- 1" x 1/4" diameter shackle

TX4100 19.95 G



- 4-pack keyed alike TX8700 padlocks Marine grade padlock
- Dual locking solid brass body
- Hardened .87" x .25" diameter shackle

348070 26.95 L

MARINE GRADE PADLOCKS

Rugged dual locking solid brass body with hardened shackle

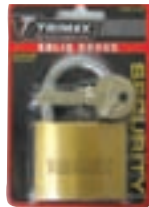

3/4" x 3/8" DIA Shackle



1.25"

TX7500 11.95 G

7/8" x 1/4" DIA Shackle



1.5"

TX8700 6.99 L

1 1/8" x 5/16" DIA Shackle



2.0"

TX1225 13.95 G

1 3/8" x 3/8" DIA Shackle



2.37"

TX1137 14.95 G

SHIELDED DOOR LOCKS



- Enlarged opening covers and secures all trailer hasps
- Solid steel thicker body with 3/8" diameter internal shackle

348041 32.95 L Each

348042 89.95 L 3 Pack Keyed Alike

LAMINATED PADLOCKS

Rugged dual locking solid steel laminated padlock with hardened shackle

7/8" x 3/16" DIA Shackle



TX8710 5.95 H

1" x 1/4" DIA Shackle



TX1000 6.95 H

7/16" DIA Shackle



TX2150 15.95 G

5/16" DIA Shackle



TX51250 10.95 G

DOOR HASP



- Epoxy coated steel 2 piece hasp for trailer & shed doors
- Designed to work with the 348041 lock

348043 27.95 L

HARDENED CHROME STEEL LOCKS

- 64mm solid steel padlock - 1-1/4" x 10mm diameter shackle. Re-keyable.

348068 22.95 L

- 64mm solid steel padlock - 2-1/4" x 10mm diameter shackle. Re-keyable.

348069 23.95 L



- tires & wheels
- axles, hubs & springs
- tongue accessories
- hitches
- electrical
- brake parts
- trailer hardware
- locks & pins
- towing & loading
- tie downs
- tools
- chemicals

TRAILER

LOCKS & PINS

- tires & wheels
- axles, hubs & springs
- tongue accessories
- hitches
- electrical
- brake parts
- trailer hardware
- locks & pins
- towing & loading
- tie downs
- tools
- chemicals



FT100



FT115



FT102

FULTON LOCKS

PART #	MFG #	DESCRIPTION	UM		
FT098	63230	COUPLER LOCK, ADJUSTABLE BRASS	EA	13.22	E
FT100	63225	TRAILER HITCH LOCK	EA	10.77	E
FT102	CLK15 0100	CABLE LOCK WITH KEY 15' STEEL CABLE IS COATED WITH DURABLE, FLEXIBLE VINYL THAT PROTECTS AGAINST CORROSION LOCKING MECHANISM IS PRE-LUBRICATED AND COATED WITH A CHIP-RESISTANT FINISH	EA	38.18	E
FT109	63226	UNIVERSAL TRAILER LOCK	EA	23.63	E
FT090	TK100 0100	TRAILER KEEPER LOCK MADE OF HEAVY-DUTY HARDENED STEEL ADJUSTABLE TO FIT MOST TRAILER WHEELS UP TO AND INCLUDING 15". INCLUDES BRASS LOCK AND KEY SET	EA	104.41	E
FT112	TP20-0103	COUPLER LOCK 2"/NEW STYLE	EA	33.37	E
FT114	63227	COUPLER LOCK 2 5/16"/ NEW STYLE	EA	34.07	E
FT115	32410	RECIEVER LOCK 1/2" DIA PIN	EA	20.45	G
FT116	32400	RECIEVER LOCK 5/8" DIA PIN	EA	20.45	G
FT119	ETCHL0700	SPARE TIRE CARRIER WITH LOCK	EA	27.01	E
444000	TP20A1534	KEYED ALIKE 2" COUPLER LOCK	EA	56.95	B
444001	STL 0603	SPARE TIRE LOCK FITS OVER WHEEL STUDS UP TO 9/16" DIAMETER REMOVABLE PLUG ALLOWS FOR LONGER WHEEL STUDS LOCKING TAB PROVIDES POSITIVE LOCKING FEATURE TO PREVENT LOCK FROM TURNING	EA	20.24	B
444002	OML 0127	OUTBOARD MOTOR LOCK MOUNTS ON MOST OUTBOARD MOTORS FOAM INSERT REDUCES NOISE AND VIBRATION LOCK COVER KEEPS MOISTURE TO A MINIMUM. SHIPS WITH TWO KEYS.	EA	36.92	B



FT119



FT090



BY253



BY5000

BUYERS LOCKS

PART #	MFG #	DESCRIPTION	UM		
BY5000	BCL500	COUPLER LATCH LOCK 1/4" PIN 3/4" ADJUSTABLE TRAVEL	EA	6.95	G
BY253	BDL253	DRAWBAR LOCK FITS ALL 2-1/2" - 3" LUNETTE EYES PADLOCK NOT INCLUDED	EA	26.95	E
BY125	BLHP125	LOCKING HITCH PIN FOR 1-1/4" RECEIVERS 1-2" DIAMETER	EA	10.95	G
BY7200	BLHP200	LOCKING HITCH PIN FOR 2" RECEIVERS 5/8" DIAMETER	EA	10.95	G
BY300	BLHP300	LOCKING HITCH PIN FOR 2" RECEIVERS BONE STYLE 5/8" DIAMETER	EA	14.95	G



BY125

TRAILER

DEAD-BOLT LOCKS



PART #	MFG #	DESCRIPTION	UM		
RC2	RC2	COUPLER LOCK FOR LEVER STYLE TRAILER INSIDE WIDTH 1/2" PIN DIAMETER 1/4" OVERALL LENGTH 4-1/8" DOUBLE NICKEL CHROME FINISH LOCK HOUSING. INCLUDES 2 KEYS.	EA	15.95	G
RHC32	RHC32	HITCH & COUPLER LOCK SET 2" RECEIVER 1/2" SPAN COUPLER FITS LEVER STYLE TRAILER COUPLERS DOUBLE NICKEL CHROME FINISH. INCLUDES 2 KEYS.	SET	31.95	G
RHC33	RHC33	HITCH AND COUPLER LOCK SET 2" RECEIVER 2" SPAN COUPLER FITS LEVER STYLE TRAILER COUPLERS DOUBLE NICKEL CHROME FINISH. INCLUDES 2 KEYS.	SET	32.95	G
CT32	UTK-32	ULTIMATE TOW KIT. LOCK YOUR HITCH, TRAILER, AND CARGO WITH ONE KEY HITCH LOCK 5/8" DIAMETER FITS 2X2 RECIEVER STYLE HITCHES MAX TORQUE 600 LBS. MAX TRAILER WEIGHT 6000LBS. KIT INCLUDES 2" BALL AND MOUNT CLASS 3,4 HITCH LOCK TRAILER COUPLER LOCK AND A 10' CABLE LOCK	EA	89.95	B

BULLDOG LOCKS



PART #	MFG #	DESCRIPTION	UM		
444016	580400	5/8" CHROME BENT PIN LOCK.	EA	17.73	B
444017	580401	5/8" CHROME DOGBONE LOCK.	EA	18.43	B
444018	580403	CHROME COUPLER LOCK.	EA	21.56	B
444019	580404	5/8" CHROME DOGBONE LOCK W/ CHROME COUPLER LOCK	EA	36.50	B
444020	580408	STAINLESS STEEL COUPLER LOCK	EA	16.55	B
444021	580406	LOCK 5/8" HITCH PIN COUPLER LOCK COMBO STAINLESS STEEL	EA	40.68	B
444022	580402	5/8" STAINLESS STEEL DOGBONE LOCK	EA	29.90	B
444081	580405	STAINLESS STEEL DOGBONE LOCK W/SLEEVE FOR 1-1/4" & 2" SQUARE RECIEVERS	EA	26.77	B
444082	580407	EASY ACCESS LOCK W/SLEEVE FOR 1-1/4" & 2" SQUARE RECEIVERS	EA	14.60	B
444083	580409	EASY ACCESS LONG COUPLER LOCK	EA	15.71	B
444084	580410	EASY ACCESS ADJUSTABLE COUPLER LOCK	EA	19.11	B

- tires & wheels
- axles, hubs & springs
- tongue accessories
- hitches
- electrical
- brake parts
- trailer hardware
- locks & pins
- towing & loading
- tie downs
- tools
- chemicals

TRAILER

LOCKS & PINS

TOW READY LOCKS



PART #	MFG #	DESCRIPTION	UM	EA	B
444003	63234	RECEIVER LOCK, FOR 1-1/4", 2" & 2-1/2" SQ. RECEIVERS W/ UNIVERSAL STAINLESS STEEL SLEEVE CAN ACCOMMODATE CLASS I, II, III, IV OR V HITCHES. SOLID STAINLESS STEEL PIN FITS CROSSWISE INTO THE HOLE ON YOUR RECEIVER WITH A DEADBOLT SECURING IT IN PLACE	EA	21.90	B
444004	63248	RECEIVER LOCK, BARREL STYLE W/BENT PINS, 1/2" FOR 1-1/4" SQ. RECEIVERS & 5/8" FOR 2" SQ. RECEIVERS. CAN ACCOMMODATE CLASS I, II, III, IV OR V HITCHES. SOLID STAINLESS STEEL PIN FITS CROSSWISE INTO THE HOLE ON YOUR RECEIVER WITH A DEADBOLT SECURING IT IN PLACE.	EA	14.61	B
444005	63224	RECEIVER LOCK, BENT PIN, 1/2" FOR 1-1/4" SQ. RECEIVERS & FIFTH WHEEL BASE RAILS. CAN ACCOMMODATE CLASS I, II, III, IV OR V HITCHES. SOLID STAINLESS STEEL PIN FITS CROSSWISE INTO THE HOLE ON YOUR RECEIVER WITH A DEADBOLT SECURING IT IN PLACE.	EA	13.22	B
444006	63223	RECEIVER LOCK, BENT PIN, 5/8" FOR 2" & 2-1/2" SQ. RECEIVERS. CAN ACCOMMODATE CLASS I, II, III, IV OR V HITCHES. SOLID STAINLESS STEEL PIN FITS CROSSWISE INTO THE HOLE ON YOUR RECEIVER WITH A DEADBOLT SECURING IT IN PLACE.	EA	13.42	B
444007	63252	RECEIVER LOCK, DOGBONE STYLE, 5/8" FOR 2-1/2" SQ. RECEIVERS, 3-1/2" SPAN. CAN ACCOMMODATE CLASS I, II, III, IV OR V HITCHES. SOLID STAINLESS STEEL PIN FITS CROSSWISE INTO THE HOLE ON YOUR RECEIVER WITH A DEADBOLT SECURING IT IN PLACE.	EA	18.90	B
444008	63253	RECEIVER LOCK, BARREL STYLE W/BENT PIN, 5/8" FOR 2-1/2" SQ. RECEIVERS, 3-1/2" SPAN. CAN ACCOMMODATE CLASS I, II, III, IV OR V HITCHES. SOLID STAINLESS STEEL PIN FITS CROSSWISE INTO THE HOLE ON YOUR RECEIVER WITH A DEADBOLT SECURING IT IN PLACE.	EA	18.23	B
444009	63216KA	RECEIVER LOCK, DEAD BOLT, 1/2" FOR 1-1/4" SQ. RECEIVERS, BLACK FINISH (KEYED ALIKE BULK)	EA	25.40	B
444010	63217KA	RECEIVER LOCK, DEAD BOLT, 5/8" FOR 2" SQ. RECEIVERS, BLACK FINISH (KEYED ALIKE BULK)	EA	24.49	B
444011	63218KA	COMBO LOCK SET, 1/2" DEAD BOLT FOR 1-1/4" SQ. RECEIVER AND TRAILER COUPLER 1/2" SPAN, BLACK FINISH (KEYED ALIKE BULK)	SET	61.52	B
444013	63220KA	COUPLER LOCK, DEAD BOLT, 1/2" SPAN, BLACK FINISH (KEYED ALIKE BULK)	EA	23.46	B
444014	63221KA	COUPLER LOCK, DEAD BOLT, 2" SPAN, BLACK FINISH (KEYED ALIKE BULK)	EA	23.53	B
444015	63222KA	COUPLER LOCK, DEAD BOLT SURGE BRAKE, 2-3/8" SPAN, BLACK FINISH (KEYED ALIKE BULK)	EA	23.53	B
444085	63249	COMBO LOCK SET, BARREL STYLE W/BENT PINS, 1/2" FOR 1-1/4" SQ. RECEIVERS, 5/8" FOR 2" SQ. RECEIVERS & ADJUSTABLE BRASS COUPLER LOCK	EA	22.95	B
444086	63250	COMBO LOCK SET, DOGBONE STYLE, 1/2" FOR 1-1/4" SQ. RECEIVERS, 5/8" FOR 2" SQ. RECEIVERS W/UNIVERSAL STAINLESS STEEL SLEEVE & COUPLER LOCK	EA	27.45	B
444087	63256	RECEIVER LOCK FITS: 1-1/4" & 2" RECEIVERS. KEYED ALIKE CONVENIENCE. INCLUDES: 1 UNIVERSAL COUPLER LOCK, 1 DUAL BENT PIN RECEIVER LOCK AND 1 ADJUSTABLE COUPLER LOCK. GUARDS AGAINST TOWED AND PARKED TRAILER THEFTS. INCLUDES THREE INTERCHANGEABLE KEYS	EA	53.32	B
444088	63219KA	COMBO LOCK SET, 5/8" DEAD BOLT FOR 2" SQ. RECEIVER AND TRAILER COUPLER 1/2" SPAN, BLACK FINISH (KEYED ALIKE) (ORDER IN 3 PACK MULTIPLES ONLY)	EA	47.25	B
444089	63233	CABLE LOCK, 5/16" X 10' LENGTH	EA	27.67	B
444090	63255	CABLE LOCK, 5/16" X 4' LENGTH	EA	12.82	B



444003



444005



444009



444010



444013

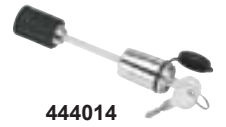

444014



444015



444085



444086



444090



444089



444088



444087

TRAILER

- tires & wheels
- axles, hubs & springs
- tongue accessories
- hitches
- electrical
- brake parts
- trailer hardware
- locks & pins
- towing & loading
- tie downs
- tools
- chemicals

BUYERS COUPLER SAFETY PINS

Buyers coupler pins are available in bulk or in display packages. The display packages are packed two per package available square loop only. Yellow zinc plated.

PART #	MFG #	A DIA WIDTH	B USABLE LENGTH	C LOOP CLEARANCE	D PIN LENGTH	STYLE	UM		
BY6050	66050	1/4"	1-13/16"	1-1/2"	2"	SQUARE	EA	0.95	J
BY6063	66063	1/4"	2-1/2"	2-1/2"	2-49/64"	SQUARE	EA	0.95	J
BY6064	66064	1/4"	2-1/2"	2-1/2"	2-49/64"	SQUARE	PKG 2	1.95	J
BY6066	66066	1/4"	3"	1-1/2"	3-1/4"	SQUARE	EA	0.95	J
BY6067	66067	1/4"	3"	1-1/2"	3-1/4"	SQUARE	PKG 2	1.95	J
BY6070	66070	1/4"	3-5/8"	1-1/2"	3-3/4"	SQUARE	EA	0.95	J
BY6053	66053	5/16"	1-5/8"	2-19/32"	2-25/32"	SQUARE	EA	0.95	J
BY6054	66054	5/16"	1-5/8"	2-19/32"	2-25/32"	SQUARE	PKG 2	1.95	H
BY6056	66056	3/8"	1-17/32"	1-17/32"	1-5/8"	SQUARE	EA	0.95	J
BY6060	66060	3/8"	2-11/32"	2-11/32"	2-1/2"	SQUARE	EA	0.95	J
BY6061	66061	3/8"	2-11/32"	2-11/32"	2-1/2"	SQUARE	PKG 2	2.95	G

PIVOT POINT COUPLER PINS

Safety lock pins have pin and cotter all in one assembly. The wire loop is pulled over the pin end to lock it in place or remove it. Quick connect or disconnect prevents coupler latch from accidentally opening. Tempered spring with carbon steel pin zinc plated.

PART #	MFG #	A DIA WIDTH	B USABLE LENGTH	C LOOP CLEARANCE	D PIN LENGTH	STYLE	UM		
PT110	WIRE-1RD	1/4"	1-3/4"	1-1/2"	2"	ROUND	EA	1.95	L
PT115	WIRE-3RD	5/16"	2-5/16"	2"	2-3/4"	ROUND	EA	1.95	L
PT101	WIRE-3SQ	5/16"	2-3/8"	1-3/4"	2-3/4"	SQUARE	EA	1.95	L
PT107	WIRE-7SQ	3/8"	2-1/8"	1-1/2"	2-1/2"	SQUARE	EA	1.95	L

BUYERS LYNCH PINS

PART #	MFG #	A DIA WIDTH	B USABLE LENGTH	C LOOP WIDTH	D PIN LENGTH	STYLE	UM		
BY6003	66003	3/16"	1-1/8"	1-5/16"	1-7/16"	FLAT ROUND	EA	0.95	B
BY6000	66000	1/4"	1-1/2"	1-11/16"	1-3/4"	FLAT ROUND	EA	0.95	B
BY6006	66006	5/16"	1-1/2"	1-3/4"	1-3/4"	FLAT ROUND	EA	0.95	G
BY6010	66010	7/16"	1-1/2"	1-3/4"	1-3/4"	FLAT ROUND	EA	0.95	J
BY6015	66015	7/16"	1-1/2"	1-3/4"	1-15/16"	FLAT ROUND	EA	0.95	J

PIVOT POINT LYNCH PINS

PART #	MFG #	A DIA WIDTH	B USABLE LENGTH	C LOOP WIDTH	D PIN LENGTH	STYLE	UM		
PT226	HANG-2	3/16"	1-1/4"	1-7/16"	1-1/2"	FLAT ROUND	EA	1.40	L
PT224	HANG-4	1/4"	1-1/2"	1-11/16"	1-3/4"	FLAT ROUND	EA	1.60	L
PT225	HANG-6	5/16"	1-5/16"	1-1/2"	1-3/4"	FLAT ROUND	EA	1.75	L

BUYERS HITCH PINS

PART #	MFG #	A DIA WIDTH	B USABLE LENGTH	C HAIR PIN WIDTH	D PIN LENGTH	STYLE	UM		
BY6100	66100	1/2"	4-3/8"	PT027	4-15/16"	LOOP END	EA	2.95	J
BY6105	66105	5/8"	6-5/16"	PT027	6-15/16"	LOOP END	EA	4.95	H
BY6110	66110	3/4"	4-7/16"	PT029	4-15/16"	LOOP END	EA	3.95	G
BY6115	66115	3/4"	6-1/4"	PT029	7"	LOOP END	EA	4.95	H
BY6120	66120	7/8"	6-5/16"	PT029	6-15/16"	LOOP END	EA	5.95	G
BY6125	66125	1"	6-1/4"	PT029	6-3/4"	LOOP END	EA	6.95	H

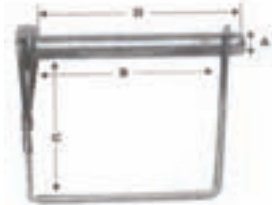
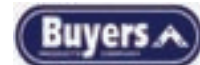

PIVOT POINT



PIVOT POINT



tires & wheels

axles, hubs & springs

tongue accessories

hitches

electrical

brake parts

trailer hardware

locks & pins

towing & loading

tie downs

tools

chemicals

TRAILER

LOCKS & PINS

- tires & wheels
- axles, hubs & springs
- tongue accessories
- hitches
- electrical
- brake parts
- trailer hardware
- locks & pins
- towing & loading
- tie downs
- tools
- chemicals

BUYERS HITCH PINS POWDER COATED

PART #	MFG #	A DIA WIDTH	B USABLE LENGTH	HAIR PIN	D PIN LENGTH	STYLE	UM		
BY6101	66101	1/2"	3-1/2"	PT027	4-1/8"	LOOP END	EA	4.95	G
BY6107	66107	5/8"	3-3/4"	PT027	4-1/4"	LOOP END	EA	5.95	G
BY6111	66111	3/4"	3-3/4"	PT029	4"	LOOP END	EA	6.95	G

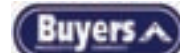

BUYERS BENT HITCH PINS

PART #	MFG #	A DIA WIDTH	B USABLE LENGTH	HAIR PIN	D PIN LENGTH	STYLE	UM		
BY190		1/2"	3-1/4"	PT026	5-1/2"	BENT	EA	1.95	J
BY200		5/8"	3-1/16"	PT028	5-1/4"	BENT	EA	1.95	H

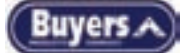

TRIMAX BENT HITCH PINS

1/2" PIN FITS CLASS I, II RECEIVERS. 5/8" PIN FIT ALL CLASS III, IV, V RECEIVERS

PART #	MFG #	A DIA WIDTH	B USABLE LENGTH	HAIR PIN	D PIN LENGTH	STYLE	UM		
TX1258	SP125	1/2"	2-1/2"	PT028	3-1/2"	BENT	EA	5.95	G
TX2010	SP200	5/8"	3-1/2"	PT028	5-3/4"	BENT	EA	5.99	G



PIVOT POINT HAIR PINS

PART #	MFG#	DIA WIDTH	PIN LENGTH	UM		
PT024	HAIR-4	1/16"	1-3/8"	EA	0.15	L
PT025	HAIR-5	3/32"	1-5/8"	EA	0.20	L
PT026	HAIR-6	3/32"	2"	EA	0.25	L
PT027	HAIR-8	1/8"	2-3/8"	EA	0.30	L
PT028	HAIR-10	5/32"	2-7/8"	EA	0.55	L
PT029	HAIR-12	3/6"	3-1/4"	EA	0.60	L

PIVOT POINT



BUYERS BENT SWIVEL HITCH PIN

FEATURES A FLIP TIP NO HAIR PINS REQUIRED.

PART #	MFG #	A DIA WIDTH	B USABLE LENGTH	SWIVEL PIN	D PIN LENGTH	STYLE	UM		
BY625	HP625SC	5/8"	2-3/4"	1-3/4"	5"	BENT FLIP TIP	EA	4.95	B

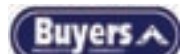

TRIMAX BENT FLIP TIP HITCH PIN

FEATURES A FLIP TIP NO HAIR PINS REQUIRED.

PART #	MFG #	A DIA WIDTH	B USABLE LENGTH	SWIVEL PIN	D PIN LENGTH	STYLE	UM		
TX1255	SCTX125	1/2"	2-1/2"	1-3/4"	4-3/4"	BENT FLIP TIP	EA	10.95	G
TX2005	SCTX200	5/8"	3-11/16"	1-3/4"	5-1/4"	BENT FLIP TIP	EA	10.95	G



TRAILER



TOWING & LOADING



TOWING & LOADING

CIPA CUSTOM TOW MIRRORS



CIPA's Custom Towing Mirrors slide over your existing mirrors to give you added towing vision. No tools required, leaves no marks or holes on your vehicle. Custom Towing Mirrors are designed to fit the applications listed below. Other fits may vary due to color, material, added features or adjustment variations.

FITS	PART #		YEAR	APPLICATIONS	EXCEPTIONS/INFO
Pair	530000	37.19	B 86-95	Dodge pickups and Vans	*86-93 fits both electric & manual chrome mirrors *94-95 Fits manual chrome mirrors only
Pair	530001	37.19	B 94-97	Dodge pickups and Vans	*94-97 fits both electric & manual black mirrors *96-97 fits electric chrome mirrors * Will not fit Dakotas with black sporty mirrors
Pair	530002	77.19	B 94-02	Dodge old style 1500, 2500, 3500	* Will not fit 5x7 Sport style mirrors
Driver	530003	38.60	B 98-03	Dodge Durango	
Passenger	530004	38.60	B 98-04	Dodge Dakota	
			B 00-03	Dodge full size Van	
Pair	530005	82.86	B		
Driver	530006	41.43	B 02-08	Dodge Ram 1500	*Does not fit Extendable mirrors on the 3500 models
Passenger	530007	41.43	B 03-08	Dodge Ram 2500, 3500	
Pair	530008	85.67	B		
Driver	530009	42.83	B 09-16	Dodge Ram 1500	*Does not fit Extendable mirrors on the 2500 models
Passenger	530010	42.83	B 09-16	Dodge Ram 2500	
Pair	530011	37.19	B 83-98	Ford full size pickups	*Fits the chrome door mount break away style mirror only
			B 83-91	Ford Ranger	
Pair	530012	77.19	B 92-97	Ford full size pickups	
Driver	530013	38.60	B 90-97	Ford Aerostar	*Fits Black, or black with chrome cap mirrors
Passenger	530014	38.60	B 92-96	Ford Bronco	
				1997 Ford F-250 & F-350 HD w/old body	
Pair	530015	77.19	B 97-04	Ford F-150,F-250 Light Duty	*Fits Contour style mirror only, Will not fit mirrors w/signal, or STX style mirrors
Driver	530016	27.95	B 97-02	Ford Expedition	
Passenger	530017	27.95	B 97-02	Lincoln Navigator	*Will not fit 2004 pickups with new body style See 11800
Pair	530018	85.67	B		
Driver	530019	42.83	B 04-14	Ford F-150, F-250 Light Duty	*Will not fit STX style mirrors
Passenger	530020	42.83	B 04-14	Ford F-150, F-250 XLT Models	* Will not fit Super Duty
Pair	530067	59.97	B 15-19	Ford F-150	
Driver	530065	29.98	B 15-19	Ford F-151	
Passenger	530066	29.98	B 15-19	Ford F-152	
Pair	530021	82.86	B		
Driver	530022	41.43	B 97-08	Ford F-250, F-350 Super Duty	
Passenger	530023	41.43	B 00-08	Ford Excursion	
Pair	530024	90.07	B		
Driver	530025	45.03	B 07-14	Toyota Tundra	
Passenger	530026	45.03	B 07-14	Toyota Sequoia	* Will not fit Sequoia Limited or Platinum Editions
Pair	530000	37.19	B 80-95	Chevy/GMC pickups & Vans	*Fits manual chrome mirrors only *Will not fit the chrome mirrors with black trim
Pair	530011	37.19	B 82-93	Chevy S-10, S-15	*Fits the chrome door-mount two point break-away style mirror only
Pair	530027	74.37	B 88-00	Chevy/GMC Full-size C/K Pickups	
Driver	530028	37.19	B 92-99	Chevy/GMC Suburban, Yukon, Kodiak	
Passenger	530029	37.19	B 92-99	Chevy Tahoe, Dually	
				91-04 Chevy/GMC Safari, Astro	
				92-99 Cadillac Escalade	
Pair	530030	55.95	B 97-04	Chevy Venture	
Driver	530031	29.95	B 97-04	GMC Sillhouette	
Passenger	530032	29.95	B 97-04	Pontiac Transport	
Pair	530033	82.86	B 99-07	Chevy/GMC Silverado, Sierra	*Fits Black capped and chrome capped models
Driver	530034	41.43	B 00-07	Chevy Tahoe, Suburban	*will not fit Full-Chrome mirrors
Passenger	530035	41.43	B 00-07	Chevy Avalanche	*Will not fit Telescopic mirrors
				00-07 GMC Denali, Yukon, Yukon XL	
				00-07 Cadillac Escalade	
Pair	530036	85.67	B 07-13	Chevy/GMC Silverado, Sierra	
Driver	530037	42.83	B 07-13	Chevy Tahoe, Suburban	
Passenger	530038	42.83	B 07-13	Chevy Avalanche	*Will not fit Telescopic mirrors
				07-13 GMC Denali, Yukon, Yukon XL	
				07-13 Cadillac Escalade	
Pair	530062	85.67	B 14-18	chevy/GMC Silverado, Sierra	
Driver	530063	42.83	B		
Passenger	530064	42.83	B		

TRAILER

- tires & wheels
- axles, hubs & springs
- tongue accessories
- hitches
- electrical
- brake parts
- trailer hardware
- locks & pins
- towing & loading
- tie downs
- tools
- chemicals



CIPA CUSTOM TOWING MIRROR REPLACEMENT HARDWARE

Lost a knob, misplaced a wedge? CIPA offers a complete line of replacement hardware.

DESCRIPTION	PART #		
VISION 180 MIRROR WITH DELUXE CAST ALUMINUM MOUNTING BRACKET	530042	228.95	B
WAVE MIRROR WITH DELUXE CAST ALUMINUM MOUNTING BRACKET	530043	174.95	B
COMP MIRROR WITH DELUXE CAST ALUMINUM MOUNTING BRACKET	530044	176.95	B
COMP UNIVERSAL MIRROR WITH DELUXE CAST ALUMINUM MOUNTING BRACKET	530045	184.95	B
EXTREME MIRROR WITH DELUXE CAST ALUMINUM MOUNTING BRACKET	530046	215.95	B
CONCEPT II MIRROR WITH HIGH STRENGTH COMPOSITE BRACKET	530047	48.95	B
COMP II MIRROR WITH HIGH STRENGTH COMPOSITE BRACKET	530048	55.95	B
ELLIPSE MIRROR WITH HIGH STRENGTH COMPOSITE BRACKET	530049	56.95	B
VERSATILE COMPOSITE HIGH STRENGTH MIRROR BRACKET	530050	24.95	B
PWC SPORT MIRRORS - BLACK	530051	25.95	B
PWC SPORT II - BLACK	530052	30.95	B
HAND MIRROR	530053	5.95	B
CLEAR SAFE-T-CLEAT	530054	45.95	B
BLACK SAFE-T-CLEAT	530055	45.95	B
WHITE SAFE-T-CLEAT	530056	45.95	B
BLACK RETRACTABLE DOCK CLEAT	530057	26.95	B
WHITE RETRACTABLE DOCK CLEAT	530058	26.95	B
ECONOMY MARINE MIRROR	530059	13.95	B
SUCTION CUP MIRROR	530060	20.95	B
BOATING SAFETY MIRROR	530061	26.95	B

- tires & wheels
- axles, hubs & springs
- tongue accessories
- hitches
- electrical
- brake parts
- trailer hardware
- locks & pins
- towing & loading
- tie downs
- tools
- chemicals



CIPA UNIVERSAL CLIP ON MIRRORS

CLIP ON TOWING MIRROR ▶

CIPA's Clip-On Towing Mirror was designed to fit large factory truck and van mirrors. Rubber straps secure the Clip-On Towing Mirror to your vehicle's existing mirror, and easy-to-adjust arms fit tightly for a steady vibration-free ride. The Clip-On Towing Mirror extends your vision further than any OE mirror ever could with a total extension of 7 inches. This mirror will not obstruct your vehicle's existing viewing area. The Clip-On Towing Mirror has a 5" by 7.5" mirror face that widens visibility, in addition to your factory mirror, for peace of mind while towing. It will fit up to a 10" mirror. The Clip-On Towing Mirror is not position specific, so it can accommodate the driver side or the passenger side of your vehicle. Installation is simple and no tools are required. The Clip-On Towing Mirror is perfect for temporary or light towing needs. It is not recommended to be used as a full time heavy-duty towing solution. For best results, remove the towing mirror when not in use, and store in a cool dry place. Expand your Horizons.



530039 14.95 B



530040 25.95 B

◀ DUAL VIEW CLIP ON TOWING MIRROR

The Dual-view Clip-On Towing Mirror provides better towing vision than any towing mirror out there! This innovative product features two fully adjustable mirror surfaces that allow you to fully customize your viewing area. The Dual-view Clip-on's large, flat mirror surface gives an accurate perspective of what is behind you, while the smaller convex surface acts as a built-in spot mirror for increased safety while driving, passing or changing lanes. Plus the fully enclosed mirror head design not only reduces wind vibration, but also ensures that the Dual-View's adjustable mirror surfaces stay right where you put them. This universal mirror features two adjustable arms and rubber straps that will not obstruct your existing mirror. Fits most 7" to 10" mirrors. Expand your Horizons.

UNIVERSAL TOWING MIRROR ▶

CIPA's Universal Towing Mirror is the mirror that you have been looking for! This member of CIPA's towing line is designed to fit the majority of vehicles, and reduce vibration, while maintaining a clean aerodynamic look on your existing mirror. This towing mirror is sure to surpass your expectations in all situations! The Universal Towing Mirror will provide enhanced safety while towing by extending your vision by a full 5 inches. This mirror features a 5 inch by 4.5 inch mirror face, and will not obstruct the view from your original factory mirror. The moveable feet, sturdy clamps, and tightening knob give you a secure fit without annoying vibration. This mirror's aerodynamic styling compliments virtually any vehicle. The Universal Towing Mirror accommodates the driver side or passenger side of your vehicle. Expand your Horizons.



530041 39.95 B

TRAILER

TOWING & LOADING

6' ALUMINUM BI-FOLDING RAMP

- tires & wheels
- axles, hubs & springs
- tongue accessories
- hitches
- electrical
- brake parts
- trailer hardware
- locks & pins
- towing & loading
- tie downs
- tools
- chemicals

- Welded aluminum construction
- Lightweight with rubber-coated tips
- 1200 lb. distributed weight capacity
- Heavy duty security straps included
- Rust and corrosion resistant
- 48" wide x 72" long



PART #	MFG #	SIZE		
532000	AR16	6' x 48"	149.95	G

6' ALUMINUM BI-FOLDING RAMP

- Welded aluminum construction
- Lightweight with rubber-coated tips
- 1200 lb. distributed weight capacity
- Heavy duty security straps included
- Rust and corrosion resistant
- 48" wide x 72" long



PART #	MFG #	SIZE		
24-001	R001XW	6' x 48"	162.95	G

7' ALUMINUM ARCHED RAMP

- Welded aluminum construction
- Lightweight with rubber-coated tips
- 1000 lb. distributed weight capacity
- Heavy duty security straps included
- Rust and corrosion resistant
- Each ramp is 12" wide x 88" long



PART #	MFG #	SIZE		
24-004	R004M	12' x 88"	179.95	G

TRAILER

6' ALUMINUM TRI-FOLD ARCHED RAMP

- Welded aluminum construction
- Lightweight with rubber-coated tips
- 1200 lb. distributed weight capacity
- Heavy duty security straps included
- Rust and corrosion resistant
- 48" wide x 72" long



PART #	MFG #	SIZE		
532001	AR04T	6' x 48"	169.95	G

7' ALUMINUM TRI-FOLD RAMP

- Welded aluminum construction
- Lightweight with rubber-coated tips
- 1200 lb. distributed weight capacity
- Heavy duty security straps included
- Rust and corrosion resistant
- 54" wide x 84" long



PART #	MFG #	SIZE		
532002	AR16T-7	7' x 54"	214.95	G

6' ALUMINUM TRI-FOLD RAMP

- Welded aluminum construction
- Lightweight with rubber-coated tips
- 1200 lb. distributed weight capacity
- Heavy duty security straps included
- Rust and corrosion resistant
- 50" wide x 72" long



PART #	MFG #	SIZE		
24-003	R003	6' x 50"	174.95	G

tires & wheels

axles, hubs & springs

tongue accessories

hitches

electrical

brake parts

trailer hardware

locks & pins

towing & loading

tie downs

tools

chemicals

TRAILER

TOWING & LOADING

- tires & wheels
- axles, hubs & springs
- tongue accessories
- hitches
- electrical
- brake parts
- trailer hardware
- locks & pins
- towing & loading
- tie downs
- tools
- chemicals

TRAILER

ALUMINUM LOADING RAMPS

- Lightweight
- Rugged
- Never Rust
- 100% Aluminum

BI-FOLD

PART #	SIZE	WEIGHT	CAPACITY		
LR444	44" x 72"	28#	1,500#	209.95	B
LR744 ☆	44" x 82"	30#	1,200#	264.95	B

Note: If you are loading a snowmobile with these ramps it is recommended that you lay something down where the skis ride. THE RUNNERS DIG INTO THE ALUMINUM VERY EASILY.

☆ SPECIAL SHIPPING POLICY

This product exceeds the standard UPS shipping size. A large package surcharge of \$45.00 will be added to your order.



TRI-FOLD



TRI-FOLD		
SIZE	FOLDED	CAPACITY
51" x 82"	17" W	1,000#
PART #	MFG #	
LR751	751TF	233.95 B

TRI-FOLD SPORT UTILITY RAMPS



- UPS shippable
- Make loading equipment easy!
- Completely assembled - tri-fold and ready in seconds
- Heavy duty riveted rungs
- Durable and rust-resistant aluminum
- Dual safety chains with S-hooks are included
- For easier loading of snowmobiles and equipment with small tires
- Ramps are designed to accommodate plywood decking (not included)
- 3 year limited warranty
- If you are loading a snowmobile with these ramps, it is recommended that you lay something down where the skis ride. The runners dig into the aluminum very easily.

PART #	MFG #	SIZE	SIZE FOLDED	WEIGHT	CAPACITY	
FT077	1121500	55" W x 75" L	18" W	46-1/2#	1500#	359.50 E



MOTORCYCLE RAMP AND RAIL FOR SMALL TRAILERS

- Rail and ramp convert boat or utility trailer to cycle carrier
- Ramp hooks into rail slot for easy on-off connection
- Parts are pre-punched to mount on trailer cross members
- Ramp can be bolted beside rail for transport
- Width: 8-1/2" • Lip: 2"
- Made of 12 gauge galvanized steel
- Edges deburred for safety

PART #	DESCRIPTION	SIZE		
CS26110	Motorcycle Rail	76-1/2"	101.95	G
CS26150	Motorcycle Ramp	48"	76.95	G



RAMP PLATE KIT

- Kit contains 2 heavy-duty steel top plates with mounting hardware
- Simply bolt ramp parts to the 2" x 8" planks or 2" x 12" planks (not included)
- Heavy-duty steel construction, black powder coated, & easy to assemble
- Includes nonslip protective pad
- Plates feature traction grips
- Sold as a pair

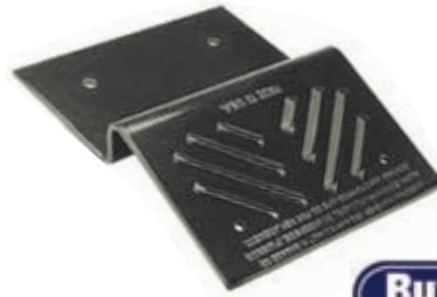

PART #	MFG #	SIZE			
BYRP8	RP8	2" x 8"	34.95	G	

RAMP PLATES

- Our aluminum loading ramp plate can quickly convert a 2" x 8" board into a quick and very inexpensive loading ramp to load your atv, motorcycle, lawn mower, etc. into your pickup or on a trailer
- Available in 2 sizes
- Sold each



PART #	MFG #	SIZE	WEIGHT		
EK7100	07100	3/16"	350#	14.90	G
EK7200	07200	1/4"	750#	25.45	G

2-PACK BOXED RAMP KIT

- Kit includes: carriage bolts, nuts, and washers
- (2) 750 lb. ramp plates (1/4")



PART #	MFG #		
EK7400	07400	49.95	G

NON-SKID THE INSTANT, SELF ADHESIVE, ANTI-SLIP SAFETY SURFACE

- Quick and easy to apply
- Peel the backing off and stick down
- Can be applied to any clean, dry smooth surface
- Non-Skid is a heavy duty long lasting, anti-slip material that produces a durable surface, defiant to all weather conditions
- With careful attention to bonding, Non-Skid will endure temperature extremes of -40 degrees to 220 degrees
- Non-Skid is waterproof under normal use

PART #	MFG #	SIZE		
IS210	RT8014	2" x 10'	12.99	G
IS410	RT8016	4" x 10'	24.99	G



REFLEX RUBBER TRACTION PAD

"THE WAY TO PROTECT YOUR TRAILER FLOOR"

- 1/2" x 18" x 10'
- Made of 100% recycled materials, largely recycled tires
- Reflex rubber traction pad is an economical solution to protect specified areas of your trailer's floor from damage resulting from your snowmobile's studded track
- Reflex rubber traction pad is a processed board product formed by blending granular crumb rubber derived from discarded tires and various low density polymer components pre-molded under heat and pressure
- Recommended fasteners: zinc or stainless screws w/ a 3/4" minimum washer (not included)
- Sold each

PART #	MFG #		
531810	MRT121810	42.95	G



tires & wheels

axles, hubs & springs

tongue accessories

hitches

electrical

brake parts

trailer hardware

locks & pins

towing & loading

tie downs

tools

chemicals

TRAILER

TOWING & LOADING



- tires & wheels
- axles, hubs & springs
- tongue accessories
- hitches
- electrical
- brake parts
- trailer hardware
- locks & pins
- towing & loading
- tie downs
- tools
- chemicals

TRAILER LIFT TRAILER LOADING & UNLOADING SHOCK SYSTEM

Finally! A sensible way to hold your ATV, Snowmobile and Motorcycle trailer in the loading or unloading "tilt" position!

- High strength steel ends
- New rust proof shock shaft
- Easy single person loading & unloading operation
- Operates smoothly in extreme temperature
- Even works for enclosed tilt trailers!



PART #	MFG #		
PD3511	PM13511	39.95	G

HEAVY DUTY LIFTARM

- Unaffected by temperature
- Zinc electro-plated steel
- 16 gauge steel tubing
- Stronger, lifts more weight
- No seals to deteriorate
- Specially treated shot-peened high tensile spring mechanism lasts for years



PART #	MFG #		
CM68	PA-CNRMPG8	99.95	B

ENFORCER TRAILER TILT BED BUDDY



- A great way to hold your tilt style trailer in the "up" position so you can load your snowmobile, atv, etc.
- Eliminates the need to find something to prop-up your trailer while loading
- Smooth operation in all weather conditions
- Fits most tilt style trailers
- Heavy duty steel ends and rust proof shaft
- Installs in minutes with basic hand tools
- Hardware & instructions included



PART #		
EF3511	37.95	G

COVERED TRAILER GAS PROPS



- Black painted finish
- 922mm extended length
- 410mm stroke
- 13mm zinc plated ball socket ends
- Gas charged
- Shock only - no mounts

ALL 3 PROPS MEASURE 37" EXTENDED & 22" CLOSED



PART #	MFG #	DESCRIPTION		
C16-17856	C16-17856	138 lbs. prop capacity	37.95	G
C16-19225	C16-19225	154 lbs. prop capacity	37.95	G
C16-22632	C16-22632	185 lbs. prop capacity	37.95	G



TRAILER	10'		12'	
	OEM (138 lbs)	HEAVY DUTY (154 lbs)	OEM (154 lbs)	HEAVY DUTY (185 lbs)
TRITON	C16-17856	C16-19225	C16-19225	C16-22632
THULE/SNO-PRO	C16-17856	C16-19225	C16-19225	C16-22632
OTHERS	C16-17856	C16-19225	C16-19225	C16-22632

PART #	MFG #	DESCRIPTION		
C16-17857	P67-00002E	13 mm Ball Stud	1.75	L
RC19	P68-00019A	Ball & Socket Retainer	0.60	L

TRAILER



MARINE SLIDES TRAILER BUNK SLIDES

Makes launching your boat or watercraft easy, slides effortlessly off bunks and into the water.

- The new unique profile provides extra cushioning between the boat and trailer bunks
- Washout channels flush sand and debris off of the slides and away from the hull
- Safer unloading and loading because of reduced friction and stress by 400% on the trailer cranking mechanisms, ropes and hull bow hooks
- Allows you to unload and load your boat or watercraft in shallower water
- Fast and simple installation for both horizontal and vertical bunks
- Made from a low-friction composite which is impervious to sun, weather and salt water
- Excellent for use on work stations, lifts, boat and watercraft dollies

PART#	MFG #	DESCRIPTION		
PD23010	23010	10 Pack - 3" x 15" Black	34.95	G
PD23011	23011	10 Pack - 3" x 15" White	34.95	G
362015	23013	10 Pack - 3" x 15" Yellow	34.95	D
362016	23030	10 Pack - 1.5" x 15" Black	19.95	B
362017	23031	10 Pack - 1.5" x 15" White	19.95	B
362018	23033	10 Pack - 1.5" x 15" Yellow	19.95	B

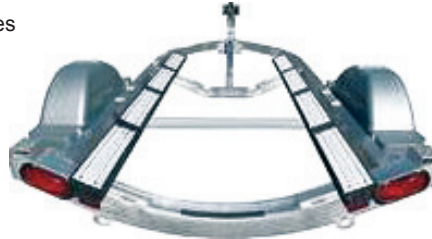

tires & wheels
axles, hubs & springs
tongue accessories
hitches
electrical
brake parts
trailer hardware
locks & pins



BUNK WRAP II RETAIL TRAILER BUNK WRAPS

Renew Your Old Shaggy Carpeted Bunks with a Permanent Solution!

- Reduce the spread of invasive species.
- Eliminate electrolysis breakdown on aluminum.
- Wraps directly over carpet or on bare wood!
- Slot fastening for wrinkle-free temp adjustment.
- Great for trailers and boat lifts!
- Made with proprietary High-Impact Glide Guard technology plastic.
- Material will not wear, crack, chip or fade.
- This is a permanent solution, GUARANTEED FOR LIFE!

PART #	MFG #	DESCRIPTION		
362011	23050	2x4 Gray on 16' Roll w/4 Endcaps & Stainless Hardware	49.99	D
362013	23052	2x6 Gray on 16' Roll w/4 Endcaps & Stainless Hardware	64.95	D
362012	23050-BK	2x4 Black on 16' Roll w/4 Endcaps & Stainless Hardware	49.99	D
362014	23052-BK	2x6 Black on 16' Roll w/4 Endcaps & Stainless Hardware	64.95	D



towing & loading
tie downs
tools
chemicals



SLYDZ-ON SPRAY-ON BUNK LUBRICANT

Makes launching your boat or watercraft easy, slides effortlessly off bunks and into the water.

- Reduces cranking torque required by as much as 275%
- Safer unloading and loading by dramatically reducing stress on the trailer crank mechanisms, ropes and hull bow hooks
- Allows you to unload and load your boat or watercraft in shallower water
- Fast and simple application for both horizontal and vertical bunks
- Made from a unique blend of anti-friction compounds
- Excellent for use on work stations, boat lifts and watercraft dollies
- Comes in 1 pint (16 fl. oz.) easy-to-use spray bottle and is applied directly to carpeted bunks

PART #	MFG #	DESCRIPTION		
PD23200	23200	16 fl. oz. Spray Bottle	14.95	G



TRAILER

TOWING & LOADING



MULTI GLIDES SIMPLIFIES LOADING AND UNLOADING OF SNOWMOBILES

Reduced friction between ski and trailer makes loading & unloading quick and easy.

- Deep channel suspends all types of carbide runners
- Wide design accommodates all dual runner skis
- Eliminates damage to trailer decking caused by carbide ski wear rods
- Multi-Glides accommodates snowmobiles with up to 7" of ski stance variance
- Multi-Glides Wide accommodates snowmobiles with up to 11" of ski stance variance
- Guaranteed not to crack, chip, break or wear out

PART #	MFG #	DESCRIPTION		
PD3305	13305	Multi-Glides - Single Set (20 Feet Total)	79.95	D
PD3306	13306	Multi-Glides Wide - Single Set (20 Feet Total)	89.95	D
PD3310	13310	Multi-Glides - Double Set (40 Feet Total)	129.95	D
PD3311	13311	Multi-Glides Wide - Double Set (40 Feet Total)	149.95	D
PD3313	13313	Multi-Glides - Extension Set (10 Feet Total)	37.95	G
PD3314	13314	Multi-Glides Wide - Extension Set (10 Feet Total)	44.95	G
PD0103	CHP0103	Multi-Glides - Screw Pack (8 Screws)	1.95	L
PD3308	CR0106	Multi-Glides - Single 5 Foot Section	16.95	G
PD3309	CR0107	Multi-Glides Wide - Single 5 Foot Section	19.95	G



FLEX GLIDES TRAILER LOADING AND UNLOADING SHOCK SYSTEM

Guides the snowmobile off your trailer and onto the ramp.

- Flex-Glides Low and High can be combined to complete enclosed V-Front trailers
- Designed to adjust to fit any V-Front trailer
- Protect your trailer and skis from unnecessary damage
- Made of high quality HDPE plastic for durability

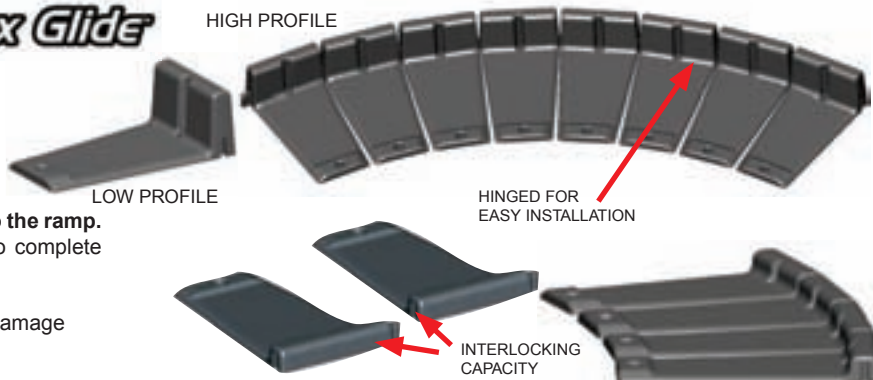

PART#	MFG #	DESCRIPTION		
PD3342	PM13342	Low Profile, 8 Piece Set	39.95	G
PD3343	PM13343	High Profile, 8 Piece Set	44.95	G



EDGE GLIDES TRAILER SNOWMOBILE SKI EDGE GLIDE SYSTEM

An innovative accessory that provides smooth Edge transition from the ground to your trailer or ramp.

- Innovative Edge Glides Measure 5 7/8" x 8 3/4"
- Incorporates Caliber's proven friction-reducing glide technology
- NEW: 10 Piece Kit spans across any door up to 8.5' Wide, and can be used to fill door gap & door bottom
- Slotted fastening system allows for expansion and contraction, preventing warp
- Integrated edge for easy assembly
- Stainless steel screws install with ease
- 9" width accommodates all skis, ski stances and ATV/UTV tires
- High-Impact plastic (HDPE), guaranteed not to crack, chip, break or warp out
- Made in USA and includes Caliber's lifetime warranty

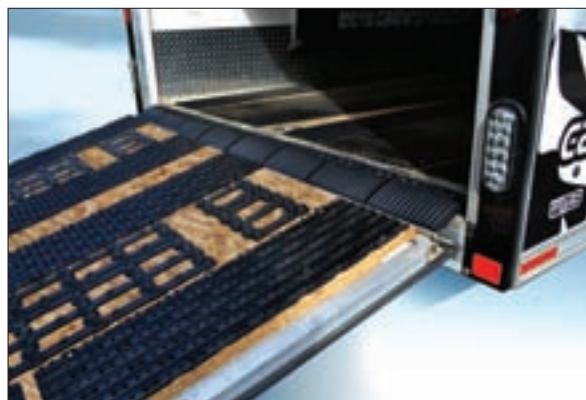

PART #	MFG #	DESCRIPTION		
22-13360	13360	Edge Glide Enclosed, Single Set (2 pcs w/Hinges) Includes Heavy Duty Hinge For Enclosed Trailers	29.95	G
22-13361	13361	Edge Glide Enclosed, Double Set (4 pcs w/Hinges) Includes Heavy Duty Hinge For Enclosed Trailers	44.95	G
362004	13524	Edge Glide Enclosed, Full Door Set (10 pcs w/Hinges) Includes Heavy Duty Hinge For Enclosed Trailers	119.95	D
22-13362	13362	Edge Glide Tilt (4 pcs w/o Hinges)	29.95	G

TRAILER

- tires & wheels
- axles, hubs & springs
- tongue accessories
- hitches
- electrical
- brake parts
- trailer hardware
- locks & pins
- towing & loading
- tie downs
- tools
- chemicals



LOWPRO GLIDES SIMPLIFIES LOADING AND UNLOADING OF SNOWMOBILES

Reduced friction between ski and trailer makes loading & unloading quick and easy.

Low profile design allows your snowmobile to glide on and off trailer without causing interference while hauling furniture or anything you need to haul.

- Eliminates damage to trailer decking caused by carbide wear rods
- Has a 45° angled edge to reduce interference
- LowPro Glides Wide (8" wide) accommodate all dual runner skis
- LowPro Glides (6" wide) now accommodate all Polaris and Woody's dual runner wear bars
- LowPro Glides accommodate snowmobiles with up to 8.5" of ski stance variance
- LowPro Glides Wide accommodate snowmobiles with up to 12.5" of ski stance variance
- HDPE guaranteed not to crack, chip, break or wear out

PART #	MFG #	DESCRIPTION		
PD3320	13320	LowPro Glides - Double Set (40 Feet Total)	129.95	D
PD3321	13321	LowPro Glides - Extension Set (10 Feet Total)	39.95	G
PD3322	13322	LowPro Glides Wide - Double Set (40 Feet Total)	149.95	D
PD3323	13323	LowPro Glides Wide - Extension Set (10 Feet Total)	44.95	G
PD0103	CHP0103	LowPro Glides - Screw Pack (8 Screws)	1.95	L
PD3325	CR0121	LowPro Glides - Single 5 Foot Section	16.95	G
PD3327	CR0122	LowPro Glides Wide - Single 5 Foot Section	19.95	G



LOWPRO GRIP GLIDES GRIPS FOR YOUR ATV AND GLIDES FOR YOU SNOWMOBILE

Designed specifically for those that carry both ATVs and snowmobiles.

- Great for Enclosed Trailer Doors and Tilt Trailers! No More Slipping!
- Provides excellent traction when loading and unloading your ATV
- Drastically reduces friction when loading and unloading your snowmobile
- 9" wide to accommodate a 14" ski stance variance
- Uniquely made to be supported off the trailer deck
- Holes on top to make washing after a muddy day effortless
- HDPE guaranteed not to crack, chip, break or wear out

PART #	MFG #	DESCRIPTION	QTY		
PD13325	13325	LowPro GripGlide Extension Set	4 pieces	59.95	G
PD13326	13326	LowPro GripGlide Single Set	8 pieces	99.95	G
PD13327	13327	LowPro GripGlide Double Set	16 pieces	189.95	G



GRIP GLIDES SNOWMOBILE TRAILER SKI GLIDE GRIP SYSTEM

- GRIP GLIDES™ kit helps to ease the loading of your snowmobile or atv onto 10' tilt trailers
- Features grips for ATV wheels and a glide pattern to suspend snowmobile wear bars
- Set includes 22 pieces, enough for one side of a 10' tilt trailer
- Two sets will complete both sides

PART #	MFG #	DESCRIPTION		
PD3350	13350	Grip Glides Ramp Set (Set of 22)	54.95	G



- tires & wheels
- axles, hubs & springs
- tongue accessories
- hitches
- electrical
- brake parts
- trailer hardware
- locks & pins
- towing & loading
- tie downs
- tools
- chemicals

TRAILER

TOWING & LOADING

tires & wheels
 axles, hubs & springs
 tongue accessories
 hitches
 electrical
 brake parts
 trailer hardware
 locks & pins
 towing & loading
 tie downs
 tools
 chemicals

TRAILER



GRIPS TRAILER SNOWMOBILE TRACK GRIP SYSTEM

Grips protect trailer decking from rot due to stud damage and make track spinning on icy trailers a thing of the past.

- Excellent traction and braking control while loading or unloading
- HDPE plastic makes Grips extremely durable
- Prevent the track from freezing to your trailer deck
- Provides superior performance as compared to any other grip type product
- Provided Stainless flathead screws mount straight through grip flange!



PART #	MFG #	DESCRIPTION	
362002	13200	Grips - 6 Pack	24.95 G
PD3200	CR0102	Grips - Sold Each (no hardware)	3.90 G



TRAX GRABBER EFFORTLESS LOADING OF YOUR SNOWMOBILES.

Modified High Density TPO with Stainless Steel Hardware for Strong Lifelong Performance.

- Innovative lug pattern provides smooth interlocking Grip for your track.
- Strategic lug placement engages 2.5", 2.86" and 3.0" pitch tracks.
- Great for all tracks including Paddle Tracks and Studded tracks.
- 16" width accommodates all track widths without overhang.
- Great Low Profile design makes for safe walking.
- High-impact plastic (TPO), guaranteed not to crack, chip, break or wear out.
- Stainless steel screws ; installs with ease will not rust.
- Flexible, Strong and Guaranteed not to break.
- Made in USA and includes Caliber's lifetime warranty.



PART #	MFG #	DESCRIPTION	
562002	23060	Trax Grabber, Double Set (2 pcs w/40 pc stainless hardware kit)	29.95 D



TRAX SAVER SAVE THE TRACK PADDLES!

Long Lasting, No Hardware Necessary

- Saves track paddles from damage during transport, by raising them off deck surface
- Easily tucks underneath paddles, once snowmobile is loaded
- Designed to work with Caliber Trax Grabber
- Made from highly durable, proprietary rubber blend



PART #	MFG #	DESCRIPTION	
362009	23062	TraxSaver (Mountain)	24.95 A



TRAXMAT THE BEST SNOWMOBILE TRACTION MAT ON THE MARKET

Stop the damage to your trailer decking or ramp caused by studded tracks.

- Provides excellent traction when loading and unloading your snowmobile
- Available in 54" and 72" length
- Extra wide 18" width
- Unique bottom groove design allows moisture to dissipate and dry out; preventing trailer deck rot



PART#	MFG #	DESCRIPTION	
PD3210	13210	TraxMat - 54"	34.95 G
PD3211	13211	TraxMat - 72"	44.95 G

Caliber V-Front Ramp Shield

V-FRONT RAMP SHIELD PROTECTION WHILE YOU TRAILER, EASIER UNLOADING WHEN YOU HAVE ARRIVED

Protects your snowmobiles, ATV's and motorcycles from road grime, rocks and salt while hauling.

- Universal design fits most open trailers
- 30" tall
- Aerodynamic design to help with gas mileage
- Our new LowPro GripGlides are installed on the ramp to make unloading your snowmobile and ATV simple
- Molded Grips down the center to give your snowmobile track traction
- Protective gate to keep your ski away from the bumper of your tow vehicle
- Lightweight HDPE guaranteed not to crack, chip, break or wear out
- Stainless steel hardware included



PART #	MFG #	DESCRIPTION		
PD3404	13404	V-Front Ramp Shield w/ LowPro GripGlides	499.95	B
362001	CA0212	V-Front Ramp Shield Adapter Kit for Triton Double Axle & Snopro V Front	129.99	B
362003	13408	V-Front Ramp Shield Handle Extender Kit (4 Piece)	39.95	G

Caliber Poly Shield III

POLY SHIELD III ULTIMATE ROAD SPRAY PROTECTION

Protects the resale value of your snowmobile, ATVs and motorcycles by deflecting corrosive salt & road spray.

- 25.5" high and fits trailers from 95" to 102" wide without modification
- Removes in seconds with included Quick-Detach kit
- Quick-Detach works on V-Front drive-on, drive-off trailers
- Will not shatter, crack, split or dent and is impervious to destructive road spray and foreign chemicals or fluids
- Unique molded spray channels enhance aerodynamics and help to direct road spray to the sides of the trailer and away from snowmobiles, ATV's, motorcycles
- Molded of HDPE plastic, providing ultra-rigid strength and the same durability proven in the truck bed liner industry
- Shield is not affected by extreme cold temperatures



NOT AFFECTED BY EXTREME COLD OR ROAD DEBRIS!

PART #	MFG #		
PD3401	13401	249.95	B

ALUMINUM SNOW SHIELD

ADJUSTABLE • DURABLE • LIGHTWEIGHT • BED MOUNT

- Universal 2 piece design
- Will fit all trailers 54" to 102" wide
- All necessary hardware included
- UPS shippable
- Boxed

PART #		
SS010	320.95	B



DIAMOND PLATE ALUMINUM SALT & SNOW SHIELD

ADJUSTABLE • DURABLE • LIGHTWEIGHT • BED MOUNT

- Side panels are not diamond plate
- Universal 2 piece design
- Will fit all trailers 54" to 102" wide
- All necessary hardware included
- UPS shippable
- Boxed

PART #		
SS025	340.95	B



- tires & wheels
- axles, hubs & springs
- tongue accessories
- hitches
- electrical
- brake parts
- trailer hardware
- locks & pins
- towing & loading
- tie downs
- tools
- chemicals

TRAILER

- tires & wheels
- axles, hubs & springs
- tongue accessories
- hitches
- electrical
- brake parts
- trailer hardware
- locks & pins
- towing & loading
- tie downs
- tools
- chemicals



D-RING ANCHOR 2 PIECE TIE DOWN KIT

Strong, durable and noiseless Tie-Down system.

- Powerful Retail Presence for Dealers.
- Each pack includes 2 D-Rings.
- Rated to 5,000 lbs.
- Kit includes all hardware.
- Flush mount so it doesn't interfere with your cargo.
- Available in Stainless Steel or Zinc Plated.
- Backer plate included, standard.

PART #	MFG #	DESCRIPTION		
362005	13520	D-Ring Set Zinc	19.99	D
362006	13521	D-Ring Set Stainless	49.99	D



CALIBER UNIVERSAL TRAILER HANDLE

Long Lasting & Durable. Fits Any Trailer.

- Easily lift your trailer onto the hitch
- Keeps hands free of pinch points
- Avoid touching the freezing cold raw metal
- 9" Long & 2 1/4" High
- Comes with mounting hardware

PART #	MFG #	DESCRIPTION		
362010	13522	Universal Trailer Handle	9.95	G



BOX TRAILER RAMP/DOOR GUIDE SYSTEM

- GRIP GLIDES™ kit helps to ease the loading of your snowmobile or atv onto enclosed trailer ramps
- Features grips for ATV wheels and a glide pattern to suspend snow mobile wear bars
- Set includes 32 pieces, enough for a standard double-wide box trailer ramp/door

PART #	MFG #	DESCRIPTION		
PD3351	13351	Grip Glides Ramp Set (Set of 32)	79.95	G



TRAILER

SNOWMOBILE TRAILER GRID RAMP GLIDE KIT

- The proven versatility of GRIP GLIDES is also available for open-frame ramps on flatbed trailers
- Set includes 16 pieces, enough for one side of a ramp
- Two sets will complete both sides

PART #	MFG #	DESCRIPTION		
PD3352	13352	Grip Glides Ramp Set (Set of 16)	39.95	G



SUPERGLIDES II PRO

The Sled and ATV Glide with Traction!

FEATURES:

- Features improved traction for your feet
- Sleds glide with ease; no more ripping up your plywood deck
- Traction for your ATV; no more spinning tires
- Moisture minimizing venting; prevents premature wood rot
- An industry's first; traction for your feet
- Kit lengths; 20' (8 pcs) 8.5" wide, includes 48 custom designed screws
- All boxes come with mounting hardware and mounting instructions
- Full kit Super-Glides (8 pc = 20' feet) includes screw/grommet kit

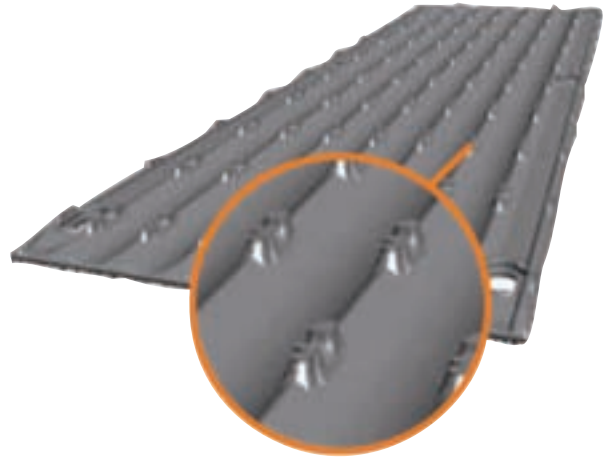

PART #	DESCRIPTION		
496000	SUPERGLIDE II Pro w/Screws	119.95	B
496004	SUPERGLIDE Edge Rail Trim Kit	59.95	A

SUPERCLAMP II

The #1 Snowmobile Tie-Down System

FEATURES:

- Installs in seconds on any trailer or truck deck
- Fully adjustable, adapts easily to fit all snowmobiles
- A single pull of the handle and your sled is secured
- Lightweight fiber-filled composite material
- Lockable with your padlock, Superclamp acts as a theft deterrent



PART #	DESCRIPTION		
23-1001	SUPERCLAMP - Front	209.95	B
496001	SUPERCLAMP - Rear w/ 12" SUPERTRAC	149.95	E
23-1003	Deck Hook (Reg. Screw Style) Most Common	17.95	B
23-1004	Deck Hook (T-Style) Channel Mount	17.95	B
496002	Deck Hook (Extra Long Screw Style)	20.95	B
496003	SUPERTRAC Deck Hook (For SUPERTRAC)	18.95	E

SUPERTRAC

The #1 Multi-Purpose Tie-Down System

The new SUPERTRAC is a multi-purpose, fully adjustable and lockable tie-down anchor system for use anywhere you need to tie down and secure cargo. SUPERTRAC can be installed in pick-up trucks, trailers, vans or just about anywhere you need to add an anchor point to tie down your cargo. Comes standard with 1 piece SUPERTRAC, SUPERTRAC Deck Hook, End caps and Stainless Steel Hardware.

PART #	DESCRIPTION		
496005	SUPERTRAC 12" Kit	38.95	G
496006	SUPERTRAC 24" Kit	47.95	B
496007	SUPERTRAC 48" Kit	69.95	D
496008	SUPERTRAC Deck Hook	18.95	E
496009	SUPERTRAC Hardware Kit	12.49	E
496010	SUPERTRAC End Caps	6.75	J



- tires & wheels
- axles, hubs & springs
- tongue accessories
- hitches
- electrical
- brake parts
- trailer hardware
- locks & pins
- towing & loading
- tie downs
- tools
- chemicals

TRAILER

TOWING & LOADING

- tires & wheels
- axles, hubs & springs
- tongue accessories
- hitches
- electrical
- brake parts
- trailer hardware
- locks & pins
- towing & loading
- tie downs
- tools
- chemicals

SKI PROTECTORS FOR TRAILER TIE DOWN BARS

- Soft vinyl construction
- Helps to prevent ski from slipping, chipping or rusting
- All protectors are 10" long
- Sold in pairs only



PART #	MFG #	SIZE	COLOR		
GP3138	12295-06	1" x 1"	Purple	8.95	L
GP3168	12316-06	1-1/4" x 1-1/4"	Purple	8.95	L

TRAILER TIE DOWN BACKING PLATE WITH NUT (3/4" HOLE)

Backing plate with nut for trailer tie down bars and cranks



PART #	MFG #	DESCRIPTION		
NM50	2ASDPLATE	Backing Plate w/nut	35.95	G

TRAILER TIE DOWN BARS

- Two sizes
- A simple and easy way to clamp your sleds down to your trailer
- Comes with rubber covered end cap for ski protection



PART #	MFG #	DESCRIPTION		
AE3327	3327	1-1/4" x 1-1/4"	27.95	B
AE3328	3328	1" x 2"	27.95	B



SKI TIE DOWN BAR

- Bar only - does not include ski protectors, crank or lock
- 1-1/2" square sturdy tubing
- 48" long with a welded hook for locking the bar in place
- 1/2" hole
- Fits over skis and secured with a crank
- Fits many of yesterday's as well as today's snowmobile trailers
- Eye bolt welded on for padlock security
- Sold each (without sleeves)

PART #	MFG #	
MA8011	1078012	37.75 G

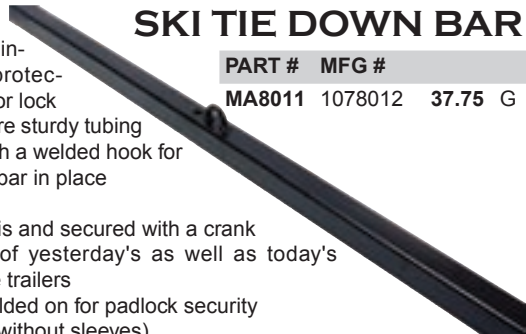

TRAILER

TIE DOWN CRANKS

- 2 lengths
- 1/2" thread

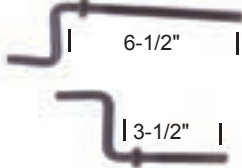

PART #	MFG #	DESC.		
220001	DMA6012	3-1/2"	12.95	G
220002	DMA6014	6-1/2"	14.95	G

TIE DOWN CRANKS

- Yellow zinc plated
- Replace your present crank with this 2" diameter swivel handle that spins freely for a quicker tie down or release with improved leverage



PART #	MFG #	DESC.		
220003	D780312	1/2" x 13	17.95	G

TIE DOWN CRANK PLATE

Bottom plate 1/8" mild steel with 1/2" nut welded on



PART #	MFG #	
621213	SM-12123	8.95 G

TRAILER WINCHES

- Comfort grip handle
- Zinc plate finish
- High carbon steel gears
- Heavy duty rib reinforced frames
- Engineered to keep handle effort low for smooth and easy operation
- Drums drilled for winch strap installation
- Only winches that are shown to accommodate steel cable should be used with steel cable
- Cable keeper kits are included with the winches specifying steel cable
- Winches rated for steel cable have a larger drum hub to reduce or lessen the chance of kinking or fraying
- **NOTE:** FULTON Winches are **NOT** designed to be a human hoist and should never be operated when there are persons on or under the load being moved
- All Fulton winches are attractively boxed for display



PART #	WEIGHT CAPACITY	GEAR RATIO	HANDLE LENGTH	STRAP SIZE	STRAP INCLUDED	MOUNTING HARDWARE	FINISH
SINGLE SPEED F2							
444091 127.57 B	1600	4.1:1	2 Position 6", 7"	20' x 2" w/Hook	YES	YES	Sharkskin
444092 170.42 B	2000	5.1:1	4 Position 6", 7", 8", 9"	20' x 2" w/Hook	YES	YES	Sharkskin
TWO SPEED F2							
444093 229.06 B	3200	5.1:1, 3.17:1	4 Position 6", 7", 8", 9"	20' x 2" w/HD Hook	YES	YES	Sharkskin

PART #	WEIGHT CAPACITY	GEAR RATIO	HANDLE LENGTH	RATCHET TYPE	ROPE	CABLE	STRAP SIZE	STRAP BOLT SIZE	STRAP INCL.
SINGLE SPEED FULTON									
FT276 40.96 E	600	3.1:1	6"	TWO WAY	36' x 1/4"	N/A	15' x 2"	1/4" x 2-1/2" GRADE 5	NO
FT290 41.92 E	900	3.1:1	7"	TWO WAY	36' x 1/4"	N/A	15' x 2"	1/4" x 2-1/2" GRADE 5	NO
444094 54.75 B	900	3.1:1	7"	TWO WAY	36' x 1/4"	N/A	15' x 2"	1/4" x 2-1/2" GRADE 5	YES
444095 57.00 B	900	3.1:1	6"	TWO WAY	36' x 1/4"	N/A	12' x 2"	1/4" x 2-1/2" GRADE 5	YES
FT277 48.22 E	1100	4.1:1	7"	TWO WAY	30' x 5/16"	N/A	20' x 2"	1/4" x 2-1/2" GRADE 5	YES
444096 58.75 B	1100	4.1:1	7"	TWO WAY	30' x 5/16"	N/A	20' x 2"	1/4" x 2-1/2" GRADE 5	NO
FT278 50.22 E	1300	4.1:1	8"	TWO WAY	30' x 5/16"	N/A	20' x 2"	1/4" x 2-1/2" GRADE 5	NO
444097 62.61 B	1300	4.1:1	8"	TWO WAY	30' x 5/16"	N/A	20' x 2"	1/4" x 2-1/2" GRADE 5	YES
444098 96.28 B	1400	4.1:1	8"	TWO WAY	N/A	N/A	20' x 2"	5/16" x 2-1/2" GRADE 5	YES
FT280 53.30 E	1500	4.1:1	8"	TWO WAY	20' x 5/16"	N/A	20' x 2"	1/4" x 2-1/2" GRADE 5	NO
444099 68.39 B	1500	4.1:1	8"	TWO WAY	20' x 5/16"	N/A	20' x 2"	1/4" x 2-1/2" GRADE 5	YES
444100 73.18 B	1600	5.1:1	9"	TWO WAY	20' x 7/16"	N/A	20' x 2"	3/8" x 2-3/4" GRADE 5	NO
FT284 78.48 E	1800	5.1:1	10"	TWO WAY	20' x 7/16"	N/A	20' x 2"	3/8" x 2-3/4" GRADE 5	NO
FT274 89.22 E	1800	5.1:1	10"	TWO WAY	20' x 7/16"	N/A	20' x 2"	3/8" x 2-3/4" GRADE 5	YES
FT304 117.57 E	1800	5.1:1	10"	TWO WAY	N/A	N/A	20' x 2"	3/8" x 2-3/4" GRADE 5	YES

PART #	WEIGHT CAPACITY	GEAR RATIO	HANDLE LENGTH	RATCHET TYPE	ROPE	CABLE	STRAP SIZE	STRAP BOLT SIZE	STRAP INCL.	HAND BRAKE	HUB SIZE
TWO SPEED FULTON											
444103 145.34 B	2000	4.1:1 & 9.8:1	10"	TWO WAY W/ NEUTRAL	N/A	N/A	20' x 2"	N/A	YES	1619-01	1"
FT288 146.56 E	2600	5.1:1 & 12.2:1	10"	TWO WAY W/ NEUTRAL	N/A	N/A	20' x 2"	N/A	NO	1619-01	1"
444106 153.01 B	2600	5.1:1 & 12.2:1	10"	TWO WAY W/ NEUTRAL	N/A	100' x 7/32"	N/A	CABLE ONLY	N/A	1619-01	1-3/4"
444107 193.95 B	3200	5.1:1 & 12.2:1	10"	TWO WAY W/ NEUTRAL	N/A	100' x 7/32"	N/A	CABLE ONLY	N/A	1619-01	1-3/4"
FT289 207.21 E	3200	5.1:1 & 12.2:1	10"	TWO WAY W/ NEUTRAL	N/A	100' x 7/32"	N/A	CABLE ONLY	N/A	INSTALLED	1-3/4"
444108 322.98 B	3700	5.1:1 & 12.2:1	10"	TWO WAY W/ NEUTRAL	N/A	90' x 7/32"	N/A	CABLE ONLY	N/A	INCLUDED	1-3/4"

tires & wheels
axles, hubs & springs
tongue accessories
hitches
electrical
brake parts
trailer hardware
locks & pins
towing & loading
tie downs
tools
chemicals

TRAILER

TOWING & LOADING

BRAKE WINCHES

Fulton brand K-Series self-activating automatic brake winches hold the load securely when the crank handle is released. Typical applications include boat lifts, grain augers, manual fork lifts, retractable swing keels, dumpster lid lifts, and manual hoists. Drum hubs are 10 times the recommended cable size to maximize cable life. The KX series offer plated gear covers for improved gear train protection and a dual ratchet system.

FULTON



444110



444111

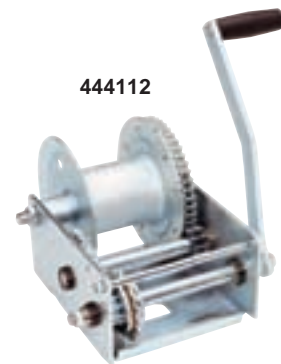

444112

PART #	1ST LAYER LBS	FULL DRUM LBS	DIAMETER	DRUM STORAGE	TEST STRENGTH LBS	GEAR RATIO	HANDLE LENGTH	DRUM HUB DIAMETER	CABLE INCLUDED	
444110	119.45	B 1000	500	7/32"	50'	5600	4.1:1	11"	2-1/4"	NO
444111	174.02	B 1500	700	1/4"	70'	7000	5.1:1	11"	2-1/2"	NO
444112	280.34	B 2500	1500	5/16"	70'	9800	15.8:1	11"	3-1/8"	NO

HAND WINCHES

- Includes hook
- Nylon strap attached
- Winch does free wheel
- Zinc plated
- 2 sizes
- Cranks in and out under load
- Full color retail package



Buyers



PART #	LOAD CAPACITY	GEAR RATIO	HUB SIZE	HANDLE LENGTH	
BY800	33.95	G 800#	4.1:1	1-1/2" x 26'	7"
BY820	67.95	E 2000#	9.8:1	2" x 20'	9.84"

XLT SERIES CUSTOMIZED WINCHES

20' WINCH STRAP W/HOOK INCLUDED

- 1400# capacity - 4.1:1 gear ratio
- Zinc plated finish on winch
- High carbon steel gears
- 8" comfort grip handle
- Two way ratchet
- Polypropylene plastic shell
- 20' x 2" drum storage strap
- Black only
- Boxed

FULTON

MADE IN THE USA



PART #	LOAD CAPACITY	GEAR RATIO	HUB SIZE	HANDLE LENGTH	RATCHET TYPE	HAND BRAKE	REPLACEMENT HANDLE #	
-----	1400#	4.1:1	3/4"	8"	Two Way	No	FT6302 16.89 E	
FT304	117.57	E 1800#	5.1:1	7/8"	10"	Two Way	No	-----

TRAILER WINCHES WITH STRAP ATTACHED

FULTON



PART #	DESCRIPTION
FT272 81.93 E	Same as FT280 1500#
FT274 89.22 E	Same as FT284 1800#

TRAILER

WINCH STRAPS

- Winch straps are 2" wide and have an overall tensile strength of 5000#
- Easy to install and no more tangling in the drum!
- Each strap is skin packaged and comes with a heavy duty forged latch hook

PART #	PRICE	SIZE	DESCRIPTION
LR50465	11.89	G 2" x 15'	5000# w/loop end
LR50470	14.01	G 2" x 20'	5000# w/loop end
LR50472	15.48	G 2" x 20'	5000# w/tail
LR50475	15.15	G 2" x 25'	5000# w/loop end



tires & wheels
axles, hubs & springs
tongue accessories

HAND WINCH STRAPS WITH CASTED HOOK

- Cast hook with safety hatch
- Bolt on
- Display packaged

PART #	PRICE	SIZE	STRENGTH	COLOR
EK06404	16.30	G 2" x 25'	3300#	Black
EK06410	23.95	G 2" x 20'	10,000#	Blue



hitches
electrical
brake parts

WINCH STRAP & HOOK

2" x 20' nylon web winch strap with loop end



FT207 15.00 E

PERSONAL WATERCRAFT WINCH STRAP

- 2" x 12' 1,800
- Includes loop nylon strap with hook

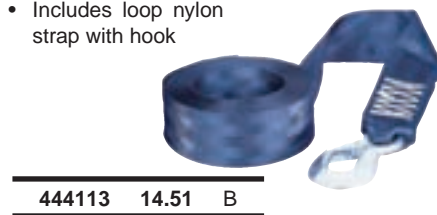

444113 14.51 B

HEAVY DUTY WINCH STRAP AND HOOK

- 2" x 20' 10,000 lb minimum breaking strength
- 4,000 lb max working load

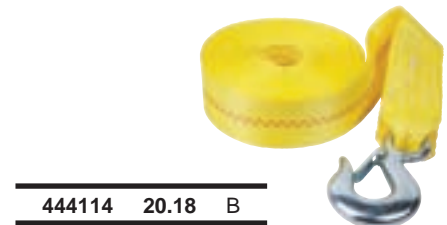

444114 20.18 B

trailer hardware
locks & pins
towing & loading

WINCH CABLES

- Galvanized steel 7 x 9 aircraft cable is made to handle the heavy loads
- Each cable is fitted with a heavy duty galvanized latch hook, pull proof loop and a fastener end for replacement use on Powerwinch, DL, Superwinch and other quality power winches
- Also great for hand crank winches

SIZE	STRENGTH	PART #	PRICE	SIZE
5/32" x 25'	2800#	LR59378	18.00	G
3/16" x 20'	4200#	LR59379	20.16	G
1/8" x 20'	2000#	LR59380	14.35	G
3/16" x 25'	4200#	LR59385	20.09	G
3/16" x 50'	4200#	LR59390	31.07	G
7/32" x 25'	5600#	LR59395	23.80	G
7/32" x 50'	5600#	LR59400	33.09	G



tie downs
tools
chemicals

SNAP HOOK

- Forged steel with tensile strength of 7500#
- Sold each (bulk)



CS16795 7.95 G



SNAP HOOKS

- Replace your worn out hook with a new zinc plated forged latch hook
- Skin packaged each

PART #	PRICE	SIZE	STRENGTH
LR50640	5.55	G	7000#
LR50645	10.44	G	7500#
LR50641	11.30	G	12,000#



WINCH HOOK & CABLE

- 3/16" x 25' galvanized cable with attached snap hook
- 4200# nominal strength



FT325 21.30 E



BOW SAFETY CHAIN

- Safety chain connects the boat to the bow stand of the trailer
- 3/16" x 15-1/2"
- Packaged each



LR81201 5.38 G

TRAILER

TOWING & LOADING

ROLLER BRACKET ASSEMBLIES

PRE-ASSEMBLED FOR EASY INSTALLATION

- Strong hot-dipped galvanized brackets hold shock-absorbing rollers to give proper keel support

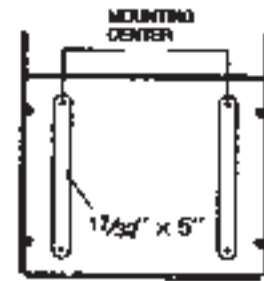

1 7/32" x 5" slot for verticle adjustment.
Attach with 1/2" or 7/16" bolts.

BLACK RUBBER

PART #			ROLLER	SHAFT	MOUNTING CENTER
CS10400	32.25	G	4" Spool	5/8"	2"
CS10401	36.45	G	5" Keel	5/8"	3"
CS10403	53.55	G	8" Keel	5/8"	6"
CS10404	61.25	G	10" Keel	5/8"	8"
CS10405	72.25	G	12" Keel	5/8"	10"

YELLOW RUBBER

CS10451	43.35	G	5" Spool	5/8"	3"
CS10453	65.95	G	8" Keel	5/8"	6"
CS10455	79.00	G	12" Keel	5/8"	10"



CS10453



CS10451

WOBBLE ROLLER RETAINER RINGS

- Packs of 2 rings with washers
- Used to hold wobble rollers



CS10980 9.45 G
Washer SAE 1-1/8"

STATIONARY KEEL ROLLER BRACKETS

- Mount on tongue or frame for keel support
- No mounting hardware included
- Sold each (bulk)

GALVANIZED



For Frame
2-3/4" Hole Centered
4" Roller

CS32100
30.95 G



For 2" Wide Tongue
2-3/4" Hole Centered
4" Roller

CS32110
30.00 G



For 3" Wide Tongue
3-1/2" Hole Centered
5" Roller

CS32150
30.75 G

ADJUSTABLE TONGUE KEEL ROLLER BRACKETS

- Offset brackets mount on tongue to hold roller for keel support
- Assembled
- Hardware included
- Display packaged
- Offset: 1"
- Length: 11-1/2"
- 3/8" diameter bolts



2 SIZES

PART #			DESCRIPTION
CS32003	41.30	G	For 3" Tongue
CS32005	40.95	G	For 2" Tongue
CS32004	14.25	G	Brackets Only, Pair

SPRING LATCH WELD ON

- 5/8" x 4" (overall) zinc plated pin
- 2-1/2" loop handle
- Stainless steel spring and a 2" x 1-1/2" x 1-1/4" steel housing
- Retaining pin extends 7/8" past housing when closed and 7/32" when open

BY2598
7.95 H
Sold Each

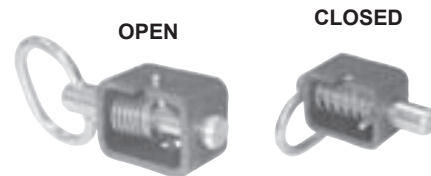

TILT LATCHES

- Designed for tilt style trailers and utility trailer gates
- Weld or bolt to tongue
- Plain base of 7 ga. steel
- Handle, spring, and plunger are zinc plated
- Sold each (bulk)

PART #			DESCRIPTION	MOUNTING
BY382	7.95	H	1/4" Four Way	Bolt On/Weld On



ANGLE "L" BRACKETS

- Use as top mounted roller bracket or as tie down
- Heavy 7 gauge steel, hot dipped galvanized for long life
- Holds 1/2" roller shaft
- 2" x 2-1/2"
- Sold in pairs



GALVANIZED

CS10211 9.35 G

TRAILER

BLACK BOAT TRAILER ROLLERS ROLLERS ARE OEM REPLACEMENTS FOR MANY TRAILERS

HD KEEL ROLLERS



PART #	LENGTH	DIA.	SHAFT
690098	19.95 G 12"	3-1/2"	5/8"
690096	16.95 G 10"	3-1/2"	5/8"
690088	14.95 G 8"	3-1/2"	5/8"

SUPER HD KEEL ROLLERS



PART #	LENGTH	DIA.	SHAFT
690055	18.95 G 8"	3-1/2"	5/8"
690053	14.95 G 5"	3"	5/8"

SPOOL ROLLERS



PART #	LENGTH	DIA.	SHAFT
690075	7.95 G 8"	3"	5/8"
690046	6.95 G 5"	3"	5/8"
690045	6.95 G 5"	3"	1/2"
690044	5.95 G 4"	3"	1/2"

MOLDED SIDE GUIDE ROLLERS



PART #	LENGTH	DIA.	SHAFT
690128	14.95 G 12"	2-1/2"	5/8"
690126	7.95 G 9"	2"	1/2"

MOLDED Y BOW STOPS



PART #	SIZE	SPAN
690032	13.95 G 4x4"	7"
690030	11.95 G 3x3"	6"
690020	11.95 G 2x2"	4"

BOW ROLLERS



PART #	SIZE	SHAFT
690036	5.95 G 4"	1/2"
690035	3.80 G 2x2"	4"

ROCKER & RIB ROLLERS

RIBBED PART #	LENGTH	DIA.	SHAFT
690158	9.95 G 3"	5"	5/8"
690155	9.95 G 3"	5"	3/4"
690154	9.95 G 3"	4-3/8"	5/8"
690153	9.95 G 3"	4-3/8"	3/4"

PLAIN PART #	DIA.	SHAFT
690150	13.95 G 4-3/8"	4" 3/4"



END CAPS FOR BOW, SPOOL, KEEL AND SIDE GUIDE ROLLERS

PART #	LENGTH	DIA.	SHAFT
690168	3.95 G 1-1/4"	3-1/2"	5/8"
690167	2.95 G 1-1/4"	3"	1/2"
690165	2.95 G 1-3/4"	2-1/2"	5/8"
690160	2.95 G 1-3/4"	2-1/2"	1/2"



THERMAL PLASTIC RUBBER (TPR) ROLLERS

TPR HEAVY DUTY KEEL ROLLERS



PART #	LENGTH	DIA.	SHAFT
690212	22.95 G 12"	3-1/2"	5/8"
690208	19.95 G 8"	3-1/2"	5/8"

TPR SPOOL ROLLERS

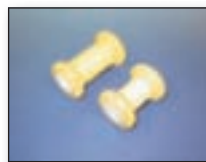

PART #	LENGTH	DIA.	SHAFT
690205	9.95 G 5"	3"	5/8"
690204	8.95 G 4"	3"	5/8"
690202	8.95 G 4"	3"	1/2"

TPR BOW ROLLERS



PART #	LENGTH	DIA.	SHAFT
690224	5.95 G 4"	3-1/2"	1/2"
690222	4.95 G 3"	3"	1/2"

TPR RIB ROLLERS



PART #	LENGTH	DIA.	SHAFT
690218	9.95 G 5"	3"	1"
690216	9.95 G 5"	3"	3/4"

TPR BOW BELLS



3-1/2"

PART #	SIZE
690210	4.95 G 1/2"

TPR END CAPS FOR BOW, SPOOL AND KEEL ROLLERS



3-1/2" x 1-1/4"

PART #	SIZE
690211	2.95 G 1/2"

TPR KEEL PADS



12" Pad, Side Hole

PART #	SIZE
690200	8.15 G

tires & wheels
axles, hubs & springs
tongue accessories
hitches
electrical
brake parts
trailer hardware
locks & pins
towing & loading
tie downs
tools
chemicals

TRAILER

TOWING & LOADING

ON THIS PAGE ARE THE NECESSARY PARTS TO MAKE YOUR OWN CUSTOM ROLLER KIT. ALL YOU DO IS PICK A BRACKET, A SHAFT AND TWO PAL NUTS. FIND THE CORRECT SIZE ROLLER ON THE FOLLOWING PAGES AND ASSEMBLE THE PERFECT SIZE.

tires & wheels

axles, hubs & springs

tongue accessories

hitches

electrical

brake parts

trailer hardware

locks & pins

towing & loading

tie downs

tools

chemicals

TRAILER

ONE-PIECE KEEL ROLLER BRACKETS



- Heavy duty one piece brackets
- which mount to cross member to hold roller
- For 5/8" shaft with 17/32" x 5" lot for adjustment
- 11 gauge steel
- Galvanized finish

PART #	ROLLER	SLOT CNTR.
CS10300	14.20 G 4"	2"
CS10301	14.95 G 5"	3"
CS10303	19.40 G 8"	6"
CS10304	20.55 G 10"	8"
CS10305	22.10 G 12"	10"

SPLIT TWO-PIECE KEEL ROLLER BRACKETS

- Two piece brackets to accommodate any length roller
- 17/32" x 5" slot for vertical adjustment
- 11 gauge steel
- Zinc plated - 5/8" shaft
- Sold in pairs only



PART # CS10500	15.70 G
----------------	---------

ZINC PLATED ROLLER SHAFTS

- Sold each (bulk)



PART #	LENGTH	DIA.
CS10700	4.81 G 5-1/4"	1/2"
CS10701	5.01 G 6-1/4"	1/2"
CS10704	1.38 H 4-5/8"	1/2"
CS10705	8.95 G 12-3/4"	1/2"
CS10721	1.80 H 5-1/4"	5/8"
CS10722	6.17 G 6-1/4"	5/8"
CS10725	7.67 G 9-1/4"	5/8"
CS10726	7.77 G 11-1/8"	5/8"
CS10727	9.24 G 13-1/2"	5/8"

PAL NUTS

- Zinc plated push on to secure rollers to shaft
- Push on metal cap
- 2 sizes
- Sold each (bulk)



PART #	SIZE
690188	0.45 E 1/2"
690190	0.50 G 5/8"

VERTICAL BUNK BRACKETS

- Galvanized bracket will adjust vertically to hold 2" bunks on edge
- Width: 2", double slots



8-1/2" long

PART #	EACH SLOT
CS10604	8.20 G 7/16" x 2-1/2"

ADJUSTABLE BUNK BRACKETS

- Zinc plated
- Heavy gauge steel brackets mount 2" bunks on edge
- Slotted vertical adjustment to standard or deep V-hulls
- Width: 2"
- Slot 17/32"

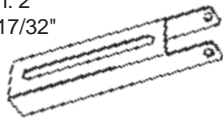

PART #	LENGTH	EACH SLOT
CS10600	7.55 G 9-1/2"	7/16" x 6"
CS10601	10.80 G 12-5/8"	17/32" x 9-1/8"

BOLSTER/SWIVEL BRACKET ASSEMBLIES

- 2-1/2" width
- Bunk mount holes 2-1/2" on center



PART #	ASSEM. LENGTH	SLOT	CTN
CS10000	11.95 G 9"	2-3/4"	48
CS10001	13.95 G 11"	3-3/4"	36
CS10002	15.95 G 13"	4-3/4"	36

STATIONARY BUNK BRACKETS

- Zinc Plated
- U-brackets mount on top of trailer cross members to hold 2" x 4" bunks on edge
- Made of 10 gauge steel

1-1/2" wide

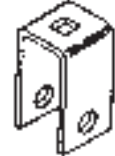

PART #	HEIGHT	BOARD SIZE
CS28104	3.25 G 2-1/4"	2 x 4

ROLLER BUNK MOUNTING BRACKET

- Galvanized swivel top bracket provides vertical and tilting adjustment for roller bunks
- Mount on trailer cross member
- Non-slip dimples for security
- Pair of bunks requires at least 4 brackets
- Slots: 17/32" x 3-3/4"
- Width: 2-1/2"
- Assembled length: 11"



PART #	DESCRIPTION
CS10003	14.60 G Assembled bracket, bulk
CS10101	9.25 G Bracket only



TAILLIGHT BRACKETS

- Galvanized brackets to hold trailer side rail
- Punched to hold lights and wiring

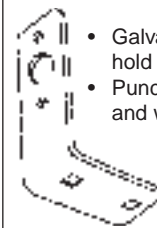

CS26057	3.15 G
---------	--------

BOLSTER SUPPORT BRACKETS

- Zinc plated
- Heavy 11 gauge steel with double slot for vertical adjustment
- Non-slip dimples for better hold
- Width: 2-1/2"
- Slot Width: 17/32"



PART #	LENGTH	EACH SLOT
CS10100	6.50 G 9"	2-3/4"
CS10101	9.25 G 11"	3-3/4"
CS10102	10.55 G 13"	4-3/4"

SWIVEL/BOLSTER BRACKET



TO CREATE THE ABOVE ORDER ONE OF EACH AND SIMPLY BOLT THE ANGLE BRACKET TO THE SUPPORT BRACKET.



SWIVEL ANGLE BRACKET

- Zinc plated
- For use with bolster brackets to secure tie downs

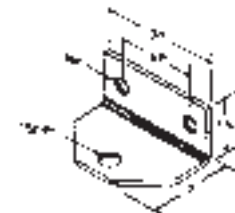

PART #	HOLE CENTERS
CS10200	2.20 G 2-1/2" on center
CS10201	2.20 G 2" on center



BOAT GUIDES TRAILER POSITIONERS

For quick, easy boat centering, in and out of the water • Ideal for boat lifts and trailers • Simple design - no moving parts to corrode, hang up or damage your boat • Fully adjustable for all popular trailers • Easy installation - no drilling required • Non-marring white finish for high visibility • Extra long mounting hardware fits all popular trailers and boat lifts • Trailer lights can be kept out of the water by attaching boat guides

Boat Guides' Extra Height Improves Visibility When Launching or Backing Up

Easy On and Off the Trailer

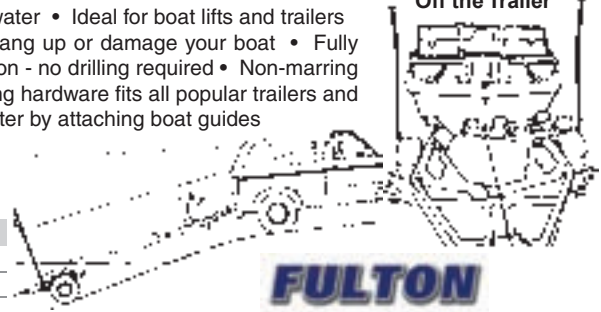

PART #		DESCRIPTION
FT158	98.89	E 44" Boat Guides with Hardware - Boxed for Display
FT160	104.63	E 50" Boat Guides with Hardware - Boxed for Display

ROLLER BUNKS

- Change bunk trailers to roller type
- Channel-style bunks pre-assembled
- Pair supports up to 1,500 lbs.
- Made of heavy gauge galvanized steel for long lasting rust protection
- Can be mounted on existing flat bunkboards, or used with our special mounting brackets (sold separately) for height and angle adjustment
- No hardware is included
- Channel: 2-1/8" W x 2-1/2" H



PART #		LENGTH	ROLLERS
CS27700	184.95	G 4'	5
CS27710	219.95	G 5'	6

HEAVY DUTY CARPETED BUNK BOARDS

- Marine grade 2" X 4" bunks covered with top quality, weather-resistant marine carpet (black) to protect hulls from scratching when launching, loading or trailering
- Long-lasting black carpet has minimal water retention, durable backing

PART #		LENGTH
CS27800	26.90	G 3 Ft.
CS27810	40.45	G 4 Ft.
CS27820	54.00	G 5 Ft.



• Sold in pairs



REPLACEMENT CARPET

- Deluxe, high quality, weather-resistant carpet renews trailer bunk appearance and protects boats from scratches
- Durable backing with minimal water retention
- Width of 10" will completely surround 2" X 4" bunk
- Black only



CS11330	21.95	G	11" x 12 Ft.	Boxed
---------	-------	---	--------------	-------

MOST TRAILER MANUFACTURERS USE GRADE 5 SCREWS AND BOLTS FOR MAXIMUM SAFETY AND SECURITY. GRADE 5 HARDWARE HAS A HIGHER TENSILE STRENGTH THAN THE GRADE 2 HARDWARE USUALLY FOUND IN HARDWARE STORES.

HEX HEAD BOLTS

- Packs of 4 bolts, washers and nuts
- Zinc plated steel, grade 5
- Used to mount tongue to trailer frame



PART #		SIZE
CS10921	0.99	J 7/16" - 14 x 1"

HEX HEAD BOLTS

- Packs of 4 bolts, washers and nuts
- Zinc plated steel, grade 5
- Can be used to mount brackets, coupler and winch stands



PART #		SIZE
CS11035	1.50	AD 3/8" - 16 x 3"

#14 PAN HEAD PHILLIPS TAPPING SCREWS

- Packs of 8 screws
- Usually used to attach vertical or horizontal wooden bunks to bunk brackets



PART #		SIZE
CS11006	0.99	J 14 x 3/4"

3/8" - 16 SLOTTED TRUSS HEAD BOLTS

- Display packages of 4 bolts, washers and nuts
- Zinc plated steel, grade 2
- Can be used to mount fenders to fender brackets



PART #		SIZE
CS10941	3.75	J 3/8" - 16 x 3/4"



PYRAMIDAL TYPE WASHERS

- Packs of 4 zinc plated star-shaped pyramidal type washers used with U-bolts for heavy duty applications
- Gripping teeth have high holding strength and will withstand extreme torques



PART #		SIZE
CS10806	2.40	G 7/16"
CS10805	2.40	G 3/8"

tires & wheels
axles, hubs & springs
tongue accessories
hitches
electrical
brake parts
trailer hardware
locks & pins
towing & loading
tie downs
tools
chemicals

TRAILER

TOWING & LOADING

BUNK BOARD GUIDE-ON BLACK CARPET INSTALLED

Carpeted bunkboards provide proper center loading in wind or side current conditions • 2" x 4" x 5 Ft. boards tilt and are covered with high grade marine carpet • Distance between galvanized upright posts can be adjusted to fit trailer • Can be mounted on top of frame for extra height • Complete in display box • Height: 21" • Adjust: out to 13" each side • Fits: Frame up to 3" W x 4-1/4" H • Tube: 1-1/2" sq. 16 ga. • Matl: Pre-galvanized steel • Angle: 75°

CS27600 182.95 G Sold Per Pair Boxed

SHORT BUNK STYLE BOAT GUIDE-ON BLACK CARPET INSTALLED

Same solid construction as our larger model • Bunk is 24" long, covered with deluxe marine carpet, and mounted with an extra strong adjustable bracket • Can be mounted on top of frame for extra height • Complete in display box • Height: 21" • Adjust: out to 13" each side • Fits: Frame up to 3" W x 4-1/4" H • Tube: 1-1/2" sq. 16 ga. Matl: Pre-galvanized steel • Angle: 75°

CS27660 159.95 G Sold Per Pair Boxed

FOR BOTH STYLES
Use kit #**CS11416** longer u-bolts for frames up to 3" x 5-1/4"
Use kit #**CS27630** for raised mounting of tail lights



JON BOAT FRONT SUPPORT BUNK

BLACK CARPET INSTALLED

Carpeted 2" x 24" bunk cushions and supports front of jon boat or other flat bottom boat • Adjusts from 5-1/2" to 8" above tongue • Place on tongue at proper length for boat • Brackets are hot dipped galvanized • Complete with mounting hardware for 2" or 3" tongue



CS27850 56.15 G Sold Per Pair Boxed

LONGER U-BOLT KIT

FOR FRAMES UP TO 3" WIDE X 5-1/4" HEIGHT

- Longer u-bolts to mount all styles of boat guides on taller trailer frames up to 5-1/4" in height
- Leg length is 6" with thread length of 2"
- 5' bunkboard style guide-on requires 2 sets, all other guide-ons require 1 set



CS11416 19.95 G Sold Per Kit Set of 4 U-bolts

ROLLER GUIDE-ON

ROLLERS ALREADY PRE-ASSEMBLED TO POSTS

Makes boat loading easier • Galvanized posts are pre-assembled with 9" roller and end caps • Can be mounted on top of frame for extra height • Complete in display box • Height: 21" • Adjust: out to 13" each side • Fits: frame up to 3" W x 4-1/4" H • Post: 1-1/2" sq. 16 ga. • Matl: pre-galvanized steel • Angle: 90°

PART # CS27610 153.25 G Sold Per Pair

REPLACEMENT PARTS

PART #	DESCRIPTION	MEASUREMENTS
690126 7.95 G	Roller	2" x 9"
690160 2.95 G	End Cap	2" x 1-3/4"
CS10705 8.95 G	Shaft	1/2" x 12-3/4"
690188 0.45 E	Cap Nut	1/2"



GUIDE-ON LIGHT BRACKETS

FOR 40" AND 60" POST STYLE

- Mounts lights out from PVC post approx. 7-1/2"
- Includes 2 formed galvanized brackets, 2 pieces of color coded 3-conductor bonded wire, 8 ft. length each, 4 terminals and 4 butt connectors plus hardware for mounting to PVC posts (does not include lights)



CS27650 42.40 G Sold Per Kit

FOR BUNKBOARD, SHORT BUNK, AND ROLLER STYLE

- Mount tail lights high and dry
- Includes 2 2-3/4" x 6" galvanized brackets plus hardware for mounting to pre-punched boat guide-on upright posts (does not include lights or wiring)



CS27630 22.05 G Sold Per Kit

TOP LIGHT KIT FOR POST STYLE BOAT GUIDES - LED

FITS INSIDE 2" PVC PIPE

- Add a pair of these amber and red lamps on top of your existing post guide-ons and see your trailer's position clearly as you back up



PART # CS27656A 36.70 G LED Top Light Kit For Post Guides, Packaged

TRAILER

TIE DOWNS

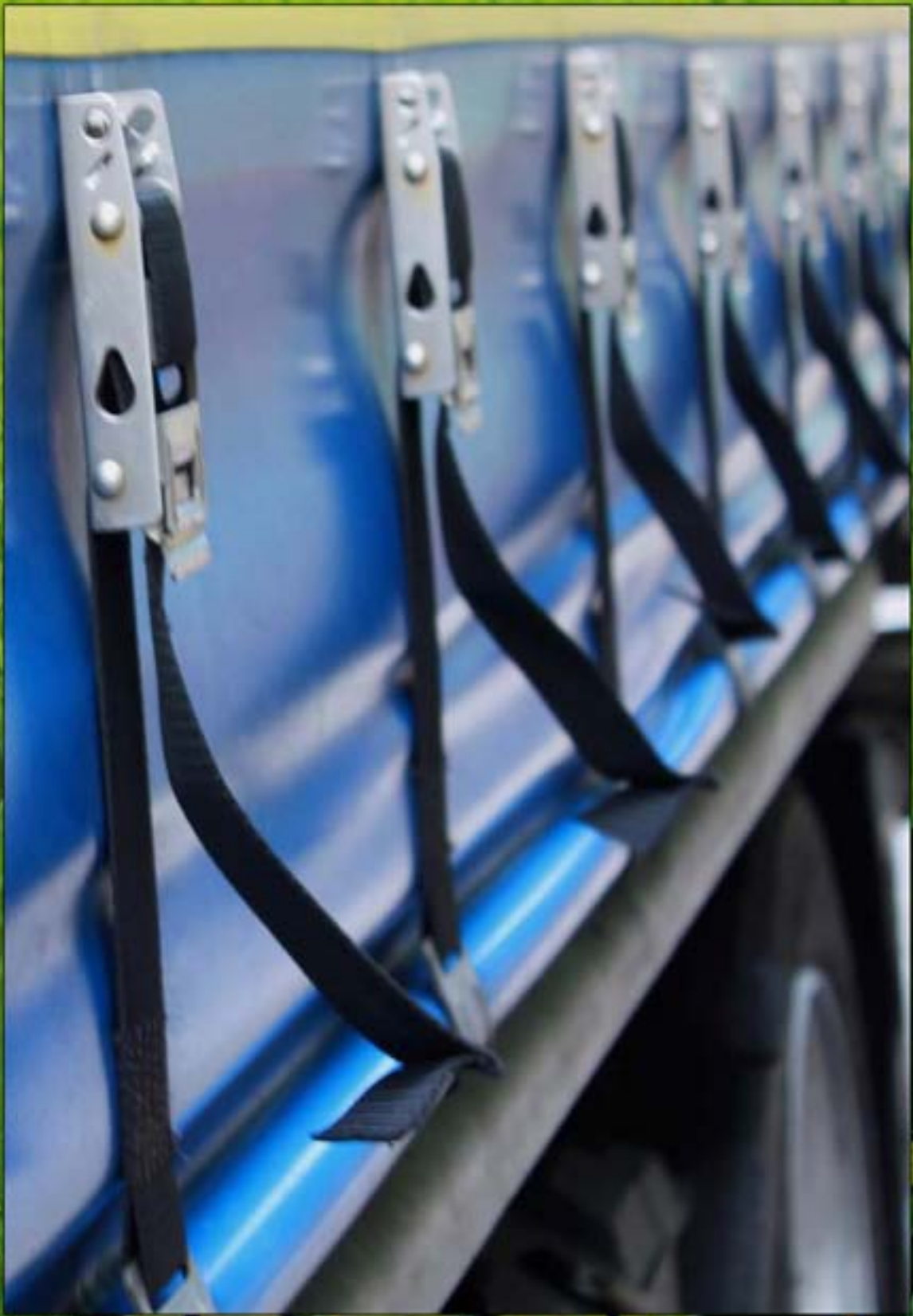

- tires & wheels
- axles, hubs & springs
- tongue accessories
- hitches
- electrical
- brake parts
- trailer hardware
- locks & pins
- towing & loading
- tie downs
- tools
- chemicals



ANCRA TIE DOWNS



GRADUAL RELEASE RATCHET INTEGRAS WITH INTEGRATED SOFT HOOKS

- Patented GRR buckle for controlled release
- Locking latch prevents handle from opening 600 lb. working load limit
- 1.5" abrasion resistant nylon webbing
- Vinyl coated s-hooks
- 5-1/2' overall length
- Packaged in pairs

PART #	MFG #	COLOR	U/M		
472009	49970-102	BLACK	PR	54.25	L
472010	49970-112	BLUE	PR	54.25	L
472011	49970-122	RED	PR	64.95	L

GRADUAL RELEASE RATCHET STANDARD TIE DOWNS

- Patented GRR buckle for controlled release
- Locking latch prevents handle from opening 600 lb. working load limit
- 1.5" abrasion resistant nylon webbing
- Vinyl coated s-hooks
- 5-1/2' overall length
- Packaged in pairs

PART #	MFG #	COLOR	U/M		
472006	49970-202	BLACK	PR	49.75	L
472008	49970-222	RED	PR	49.75	L



CAM BUCKLE INTEGRAS WITH INTEGRATED SOFT HOOKS

- 2,100 lbs. rated heavy duty cam buckle with cam plate
- 600 lb. working load limit
- 1.5" abrasion resistant nylon webbing
- Vinyl coated s-hooks
- 5-1/2' overall length
- Packaged in pairs

PART #	MFG #	COLOR	U/M		
472003	49494-202	RED	PR	61.95	L
472004	49494-212	BLACK	PR	53.00	L
472005	49494-222	BLUE	PR	53.00	L



CAM BUCKLE STANDARD TIE DOWNS

- 2,100 lbs. rated heavy duty cam buckle with cam plate
- 600 lb. working load limit
- 1.5" abrasion resistant nylon webbing
- Vinyl coated s-hooks
- 5-1/2' overall length
- Packaged in pairs

PART #	MFG #	COLOR	U/M		
472001	49494-112	BLACK	PR	48.50	L



TRAILER



ORIGINAL RED TIE DOWNS

- 1" x 5-1/2'
- One inch air-craft quality nylon webbing and Ancra's patented pressure plate cam buckle
- Vinyl coated "S" hook protects chrome and paint and attaches firmly to trunk or trailer
- The Original "Red" also features a sewn hand loop for ease of cinching
- Complete tie down instructions included
- 1,200 lbs. straight tension and 2,400 lbs looped tension
- One pair per package

PART #	MFG #	COLOR	U/M		
AN408810	40888-10	RED	PR	24.90	L

ANCRA TIE DOWNS



CLASSIC BLACK TIE DOWNS

- 1" x 5-1/2'
- Like the Original Red, this tie down has been a top seller for years
- Ancra's 'Black' strap is engineered to last with weather and abrasion resistant one inch wide nylon webbing
- It comes with vinyl coated end hooks and fasteners
- Loop end strap for a better grip
- It also has a pressure plate cam buckle
- 1,200 lbs. straight tension and 2,400 lbs looped tension
- One pair per package

PART #	MFG #	COLOR	U/M		
AN408826	40888-26	BLACK	PR	24.90	L



ATV RAT PAK

- 1" x 5-1/2'
- 1" ratchet Buckle version of the Original tie down
- Webbing - 4,500 lb. tensile strength nylon
- Buckle - 4,400 lb. rated 1" ratchet buckle
- Hooks - 2 ea. 1,200 lb. rated vinyl "S" hooks (1 vinyl coated, 1 plated) per strap
- Working load capacity - 400 lb. per strap
- Minimum assembly strength - 1,200 lb. per strap
- Packaged in pairs

PART #	MFG #	COLOR	U/M		
AN473910	47439-10	RED	PR	33.00	L

ATV QUAD PAK

- 1" x 5-1/2'
- 4 pack of Ancra's Original Reds and Rat Pak for securing larger motorcycles and atvs
- Webbing - 4,500 lb. tensile strength nylon
- Buckle - 4,400 lb. rated 1" ratchet buckle and 1,800 lb. rated cam buckle with pressure plate
- Hooks - 2 ea. 1,200 lb. rated vinyl coated hooks on each original red and 1 ea. vinyl coated hook and 1 ea. plated hook on each rat pak strap
- Overall length length - 66"
- Minimum assembly strength - 1,200 lb. per strap
- Working load capacity - 400 lb. per strap
- Packaged in 4 strap sets of 2 each
- 1,200 lbs. straight tension and 2,400 lbs looped tension

PART #	MFG #	COLOR	U/M		
AN452110	45211-10	RED	PR	54.50	L



12" SOFT HOOK EXTENSIONS

- Ancra's soft-hook offers the best protection when transporting
- The one inch black nylon webbing acts as a tie down extension or loops around the handlebars or rear seat rails, eliminating hard contact of steel hooks
- Assembly strength of each soft hook is 3,000 lbs.
- Packaged in pairs

PART #	MFG #	COLOR	U/M		
AN459211	45214-14	BLACK	PR	6.80	L

13' GENERAL PURPOSE RED TIE DOWN

- Longer version of the Ancra Originals
- Webbing - 4,500 lb. tensile strength nylon
- Buckle - 1,800 lb. rated heavy duty cam buckle with pressure plate
- Hooks - 2 ea. 1,200 lb. rated vinyl coated "S" hooks per strap
- Overall length - 13" with sewn hand loop
- Minimum assembly strength - 1,200 lb. per strap
- Working load capacity - 400 lb. per strap
- All components are made in the USA

PART #	MFG #	COLOR	U/M		
AN408825	40888-25	RED	PR	25.10	L



- tires & wheels
- axles, hubs & springs
- tongue accessories
- hitches
- electrical
- brake parts
- trailer hardware
- locks & pins
- towing & loading
- tie downs**
- tools
- chemicals

TRAILER

ERICKSON TIE DOWNS



- tires & wheels
- axles, hubs & springs
- tongue accessories
- hitches
- electrical
- brake parts
- trailer hardware
- locks & pins
- towing & loading
- tie downs
- tools
- chemicals



RETRACTABLE RATCHETING TIE DOWN STRAPS

- (2 ea.) 1" x 6' - 1,500#
- Work load limit 500#
- Simple to operate. Just pull web out to the desired length and start ratcheting until tight. To release, push down on red release button
- Display packaged
- Black

PART #	MFG #	COLOR	U/M		
EK34413	34413	BLACK	PR	28.70	G

RETRACTABLE RATCHETING TIE DOWN STRAPS

- (2 ea.) 2" x 6' - 4,000#
- Work load limit 1,333#
- Simple to operate. Just pull web out to the desired length and start ratcheting until tight. To release, push down on red release button
- Display packaged
- Black

PART #	MFG #	COLOR	U/M		
EK34414	34414	BLACK	PR	51.30	G



RETRACTABLE TIE DOWN STRAPS

Erickson's new patented design is the next step up in the Tie-Down industry. The Retractable are so simple to operate – simply pull the web out to the desired length and start ratcheting until tight. To release, simply push down on the RED release button. The web not being used is stored in the center housing so you have no web blowing in the wind. This feature also keeps the straps clean and Free from oil and dirt. Our interactive packaging design lets the customer operate the Re-Tractable ratchet right in the dealer's store. The self-sell feature saves a lot of wasted dealer selling time.

PART #	MFG #	COLOR	U/M		
266015	34415	BLACK	PR	30.95	G
266016	54415	BLACK	EA	16.95	G

ATV TIE DOWN STRAPS

- (3 ea.) 1" x 5' - 750#
- Maximum load is an actual lift load, all straps are tested in this method and rated 25% less than the actual break point
- The weakest point in most cases is the hook
- Each set has 1" x 5' nylon webbing and 3/8" 90° vinyl coated hooks
- Maximum load of 700#
- Display packaged
- Red

PART #	MFG #	COLOR	U/M		
EK06300	06300	RED	SET OF 3	19.95	G





ERICKSON TIE DOWNS



- tires & wheels
- axles, hubs & springs
- tongue accessories
- hitches
- electrical
- brake parts
- trailer hardware
- locks & pins
- towing & loading
- tie downs
- tools
- chemicals

CAM BUCKLE TIE DOWNS

- (4 ea.) 1" x 5 1/2' - 900#
- Quick lock cam buckles
- Heat treated vinyl coated hooks

PART #	MFG #	COLOR	U/M
EK5605	05605	RED	SET OF 4 22.35 G



STAINLESS STEEL RATCHETING TIE DOWNS

- (4 ea.) 1" x 6' - 1,200#
- Stainless steel ratchet
- Black

PART #	MFG #	COLOR	U/M
266000	05515	BLACK	SET OF 4 55.95 G



CAM LOCK TIE DOWNS

- (2 ea.) 1" x 6' - 1,200#
- Features the traditional pull and lock cam buckles
- Blue

PART #	MFG #	COLOR	U/M
EK34403	34403	BLUE	PR 13.20 G
266014	35605	BLUE	SET OF 4 24.95 G



RATCHETING TIE DOWNS

- 1" x 6' ratchet straps
- 1,200 lb. maximum load capacity
- Black
- 4-pack

PART #	MFG #	COLOR	U/M
EK05511	05511	BLACK WITH RED TRACER	SET OF 4 30.30 G



RETRACTABLE TIE DOWN STRAP

Erickson's new patented design is the next step up in the Tie-Down industry. The Retractable are so simple to operate – simply pull the web out to the desired length and start ratcheting until tight. To release, simply push down on the RED release button. The web not being used is stored in the centre housing so you have no web blowing in the wind. This feature also keeps the straps clean and Free from oil and dirt. Our interactive packaging design lets the customer operate the Re-Tractable ratchet right in the dealer's store. The self-sell feature saves a lot of wasted dealer selling time. (4 ea.) 1" x 6' - 1,500#. Re-tractable ratchet. Black.

PART #	MFG #	COLOR	U/M
266043	34420	BLACK	SET OF 4 50.95 G



TRAILER

TIE DOWNS

ERICKSON TIE DOWNS



- tires & wheels
- axles, hubs & springs
- tongue accessories
- hitches
- electrical
- brake parts
- trailer hardware
- locks & pins
- towing & loading
- tie downs
- tools
- chemicals



DELUXE RUBBER HANDLE RATCHETING TIE-DOWNS

- (4 ea.) 1" x 6' - 2,000#
- Deluxe rubber handle ratchet
- Red

PART #	MFG #	COLOR	U/M		
266005	05519	RED	SET OF 4	44.95	G

SPORTSMAN ATV KITS

- (4 ea.) 1" x 6' - 2,000#
- Ratchet strap
- Blue

PART #	MFG #	COLOR	U/M		
266006	05513	BLUE	SET OF 4	32.95	G



SPORTSMAN TIE DOWN STRAPS

- 1" x 6'
- 2,000 lb. rated
- TCS buckle straps
- Over center lock buckle has no teeth to damage the web
- Simply attach your hooks and pull loose ends through the buckle, flip handle down and lock into safety tab
- Hunter orange
- 4-pack

PART #	MFG #	COLOR	U/M		
266001	05740	HUNTER ORANGE	SET OF 4	27.95	G



RATCHETING TIE DOWN WITH WEB CLAMP

Erickson's Strap Trap holds the excess web not being used by simply clamping it into the ratchet handle so it can't blow in the wind. the clamping mechanism is much like a mouse trap, lift the spring loaded clamp and place the folded webbing under the clamp, release the strap trap and you have trapped the excess web.

SIZE	MAX LOAD	SAFE WORKING LOAD	QTY	MFG #			
1" x 15'	1,500#	500#	1 pack	31351	EK31350	10.60	G
1" x 8'	1,500#	500#	2 pack	31352	EK31351	16.75	G
1" x 15'	1,500#	500#	4 pack	31350	EK31352	33.10	G



TRAILER



ERICKSON TIE DOWNS



- tires & wheels
- axles, hubs & springs
- tongue accessories
- hitches
- electrical
- brake parts
- trailer hardware
- locks & pins
- towing & loading
- tie downs
- tools
- chemicals

RATCHETING TIE DOWNS W/CAMO WEBBING

- (4 ea.) 1" x 10' - 900#
- Quick lock cam buckles
- Heat treated vinyl coated hooks

PART #	MFG #	COLOR	U/M		
EK1419	01419	CAMO	SET OF 4	29.80	G



RUBBER HANDLE RATCHETING TIE-DOWNS

- (4 ea.) 1" x 10' - 1,200#
- Heat treated vinyl coated hooks
- Fully rubberized handle and thumb release

PART #	MFG #	COLOR	U/M		
EK1415	01415	BLUE	SET OF 4	25.95	G



RATCHETING TIE-DOWN STRAPS

- (4 ea.) 1" x 10' - 900#
- Ratchet strap
- Red

PART #	MFG #	COLOR	U/M		
266003	01418	RED	SET OF 4	22.95	G



RATCHETING TIE-DOWNS

- 1-1/4" x 12' - 2,500#
- Long handle ratchet with moulded rubber handles
- Allows ease in operation
- Strong silver polyester web

PART #	MFG #	COLOR	U/M		
266012	34411	GRAY	SET OF 4	51.95	G
266013	34412	GRAY	PR	26.95	G

RATCHETING TIE DOWNS

- 1" x 15' - 1,200#
- Patented molded rubber handles
- Display packaged
- Blue

PART #	MFG #	COLOR	U/M		
266010	31415	BLUE	SET OF 4	30.95	G
EK34400	34400	BLUE	PR	15.90	G



TRAILER

ERICKSON TIE DOWNS



- tires & wheels
- axles, hubs & springs
- tongue accessories
- hitches
- electrical
- brake parts
- trailer hardware
- locks & pins
- towing & loading
- tie downs
- tools
- chemicals



RATCHETING TIE DOWNS

- 1" x 15' - 1,200#
- High-quality yellow chromate-plated ratchets
- Red

PART #	MFG #	COLOR	U/M		
266008	31418	RED	SET OF 4	27.95	G
266009	34401	RED	PR	14.95	G

RATCHETING TIE DOWNS

- 1" x 15' - 2,000#
- Wide handle molded rubber handles make tightening easy on handle
- Display packaged
- Orange

PART #	MFG #	COLOR	U/M		
EK34404	34404	ORANGE	PR	23.90	G
266011	31416	ORANGE	SET OF 4	44.95	G



RATCHET STRAP W/DOUBLE FLOATING RING

- 1" x 15' - 3,000#
- Ratchet strap with double floating ring
- Black

PART #	MFG #	COLOR	U/M		
266019	01314	BLACK	EA	18.95	G

RATCHET STRAP

- 2" x 15' - 5,000#
- Ratchet strap
- Yellow

PART #	MFG #	COLOR	U/M		
EK2300	02300	YELLOW	EA	29.20	G





ERICKSON TIE DOWNS

RATCHETING LOGISTIC STRAPS

- 2" x 20' - 3,500#
- Ratchet logistic strap, bulk
- Blue

PART #	MFG #	COLOR	U/M		
266026	59140	BLUE	EA	17.95	G



AXLE STRAP

- 2" x 24" - 5,000#
- Axle strap, bulk
- Blue

PART #	MFG #	COLOR	U/M		
266027	58506	BLUE	EA	4.95	G

RATCHET STRAPS

- 2" x 25' - 5,000#
- Ratchet logistic strap, 1 pack
- Yellow

PART #	MFG #	COLOR	U/M		
EK2400	02400	YELLOW	EA	34.75	G



CAMO WEB

- Rubber handle ratchet and release with vinyl coated hooks
- 2" x 27' - 10,000#
- 3,300# working load limit
- Sold each (bulk)

PART #	MFG #	COLOR	U/M		
EK68655	68655	CAMO	EA	33.25	G

ASSIST STRAPS

- 1" x 18" - 2,000#
- 2-pack

PART #	MFG #	COLOR	U/M		
266017	06303	BLACK	PR	3.95	G
266018	06304	RED	PR	3.95	G



tires & wheels
axles, hubs & springs
tongue accessories
hitches
electrical
brake parts
trailer hardware
locks & pins
towing & loading
tie downs
tools
chemicals

TRAILER

ERICKSON TIE DOWNS



- tires & wheels
- axles, hubs & springs
- tongue accessories
- hitches
- electrical
- brake parts
- trailer hardware
- locks & pins
- towing & loading
- tie downs
- tools
- chemicals



12" CHROME PROTECTOR

- Fits 1" to 2" webbing
- 100% polyester/simulated sheepskin
- 1 pack

PART #	MFG #	COLOR	U/M		
266044	06305	N/A	EA	4.95	G

TCS BUCKLE

- 1" x 5' - 1,200#
- Security lock buckles, 3 pack
- Camo

PART #	MFG #	COLOR	U/M		
EK5726	05726	CAMO	SET OF 3	28.90	G



ADJUSTABLE TIRE STRAP W/RATCHET

- 10,000#
- Adjustable tire strap, 1 pack
- Yellow

PART #	MFG #	COLOR	U/M		
EK08522	08522	YELLOW	EA	46.60	G

COMBO PACK

- (2) 1" x 10' - 1,200# ratchets
- (2) 1" x 6' - 900# cam straps
- 4 pack
- Blue and red

PART #	MFG #	COLOR	U/M		
266002	05606	RED, BLUE	SET OF 4	24.95	G





ERICKSON TIE DOWNS



- tires & wheels
- axles, hubs & springs
- tongue accessories
- hitches
- electrical
- brake parts
- trailer hardware
- locks & pins
- towing & loading
- tie downs
- tools
- chemicals

16-PIECE STRAP PACK

- (2) 1" x 15' – 500 lb. Rubber Handle Ratchet Straps
- (1) 1" x 10' – 300 lb. Cam Strap
- (1) 1" x 10' Utility Strap
- (2) 1" x 6' Handy Straps
- Deluxe Bungee Cords 2 ea. 18", 24", 36"
- (4) Mini Bungee Cords

PART #	MFG #	COLOR	U/M		
266004	03000	N/A	EA	32.95	G



STRAP HANGER

- Strap hanger, bulk
- Black

PART #	MFG #	COLOR	U/M		
266007	58000	BLACK	EA	7.95	G

TOW ROPE

- 1/2" x 14' - 2,000# breaking strength, 1,000# maximum vehicle weight
- Includes storage bag

PART #	MFG #	COLOR	U/M		
EK9103	09103	YELLOW	EA	13.95	G



TOW ROPE

- 7/8" x 14' - 8,500# breaking strength, 4,200# maximum vehicle weight
- Includes storage bag

PART #	MFG #	COLOR	U/M		
EK9102	09102	BLUE	EA	17.80	G

RECOVERY STRAP

- 1" x 15' - 7,500# breaking strength, 3,750# maximum vehicle weight
- Includes storage bag

PART #	MFG #	COLOR	U/M		
266028	59350	WHITE	EA	24.95	G



TRAILER

ERICKSON TIE DOWNS



- tires & wheels
- axles, hubs & springs
- tongue accessories
- hitches
- electrical
- brake parts
- trailer hardware
- locks & pins
- towing & loading
- tie downs
- tools
- chemicals



TOW STRAP

- 2" x 15' - 8,500#
- With forged hooks and blue polyester web

PART #	MFG #	COLOR	U/M		
EK34405	34405	BLUE	EA	20.25	G

TOW STRAP WITH FORGED SAFETY SNAP HOOK

- 2" x 20' - 10,000# breaking strength, 5,000# maximum vehicle weight

PART #	MFG #	COLOR	U/M		
266029	09301	BLUE	EA	34.95	G



DELUXE RUBBER HANDLE RATCHET (LONG)

- 2" x 27' - 10,000#
- Long Handle
- Deluxe Molded Rubber Handle
- Vinyl Coated Double J-Hooks
- Velcro Strap Wrapper
- 10 per Display Box
- 24 cases per Pallet

PART #	MFG #	COLOR	U/M		
EK69627	69627	YELLOW	EA	34.60	G

10,000 LB. MINI WINCH

- 2" - 10,000#
- Sold each, bulk

PART #	MFG #	COLOR	U/M		
266021	52804	N/A	EA	15.95	G





ERICKSON TIE DOWNS

TIGHTENING BAR

- 10"
- Sold each

PART #	MFG #	COLOR	U/M		
266024	52802	N/A	EA	5.95	G



WEB PROTECTOR

- Sold each, bulk

PART #	MFG #	COLOR	U/M		
266025	59708	WHITE	EA	2.95	G

HAND WINCH STRAP

- 2" x 20' - 10,000#
- Sold each, packaged

PART #	MFG #	COLOR	U/M		
EK06410	06410	BLUE	EA	23.95	G



HAND WINCH STRAP

- 2" x 25' - 3,300#
- Sold each, packaged

PART #	MFG #	COLOR	U/M		
EK06404	06404	BLACK	EA	16.30	G

WINCH STRAP

- 2" x 27' - 5,000#
- Sold each, packaged

PART #	MFG #	COLOR	U/M		
266022	03100	YELLOW	EA	16.95	G



- tires & wheels
- axles, hubs & springs
- tongue accessories
- hitches
- electrical
- brake parts
- trailer hardware
- locks & pins
- towing & loading
- tie downs**
- tools
- chemicals

TRAILER

ERICKSON TIE DOWNS



- tires & wheels
- axles, hubs & springs
- tongue accessories
- hitches
- electrical
- brake parts
- trailer hardware
- locks & pins
- towing & loading
- tie downs**
- tools
- chemicals



WINCH STRAP WITH FLAT HOOK

- 2" x 30' - 10,000#
- Sold each, bulk

PART #	MFG #	COLOR	U/M		
266023	58600	YELLOW	EA	22.95	G

STANDARD BUNGEY 2-PACK

- 2 pack

SIZE	PART #	MFG #			
13"	EK6645	06645	2.45	G	
18"	EK6646	06646	2.60	G	
24"	EK6647	06647	2.75	G	
30"	EK6648	06648	3.15	G	
36"	EK6649	06649	3.85	G	



10" MINI BUNGEY 4-PACK

- 10"
- 4 pack

PART #	MFG #	COLOR	U/M		
EK6699	06699	MULTI	SET OF 4	1.80	G

FLAT BUNGEY

A hardened metal wire form is placed in the center of the molded polycarbonate hook making it super strong.

SIZE	PART #	MFG #		
12"	EK06912	06912	2.90	G
18"	EK06918	06918	3.15	G
24"	EK06924	06924	3.25	G
30"	EK06930	06930	3.45	G
36"	EK06936	06936	3.60	G
42"	EK06942	06942	3.85	G



DELUXE BUNGEY

- Talk about quality! That's what the deluxe bungee is all about
- An Industrial grade bungee comes secured to a molded polycarbonate hook with a hardened wire insert molded in
- 3 sizes available in 3 colors

SIZE	COLOR	PART #	MFG #		
12"	RED	EK07012	07012	2.55	G
24"	BLUE	EK07024	07024	3.10	G
36"	YELLOW	EK07036	07036	3.55	G



TRAILER



ERICKSON TIE DOWNS

12 PACK JAR ASSORTMENT

Solid colors

- 4 - 10" x 4mm
- 2 - 18" x 8mm
- 2 - 24" x 8mm
- 2 - 30" x 9mm
- 2 - 36" x 10mm

PART #	MFG #	COLOR	U/M		
EK6621	06621	MULTI	EA	11.65	G



25 PACK JAR ASSORTMENT

Bright red, blue, green, and yellow

- 6 - 10" x 4mm
- 5 - 18" x 8mm
- 5 - 24" x 8mm
- 2 - 30" x 9mm
- 2 - 36" x 10mm

PART #	MFG #	COLOR	U/M		
EK6622	06622	MULTI	EA	21.50	G

RUBBER TARP STRAP 10-PACK

- 4 - 9"
- 2 - 15"
- 2 - 21"
- 2 - 31"

PART #	MFG #	COLOR	U/M		
EK06610	06610	BLACK	EA	14.45	G

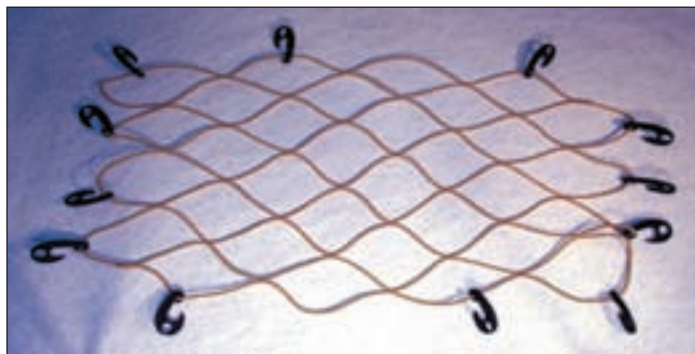

CARGO NET

- Popular size for car tops, sport utility, mini vans, etc.
- Features strong 6mm stretch cord and 12 plastic hooks
- Attractive clam shell packaging
- Expands to size 36" x 48"
- Black

PART #	MFG #	COLOR	U/M		
EK1010	01010	BLACK	EA	14.25	G

- tires & wheels
- axles, hubs & springs
- tongue accessories
- hitches
- electrical
- brake parts
- trailer hardware
- locks & pins
- towing & loading
- tie downs
- tools
- chemicals

TRAILER

- tires & wheels
- axles, hubs & springs
- tongue accessories
- hitches
- electrical
- brake parts
- trailer hardware
- locks & pins
- towing & loading
- tie downs
- tools
- chemicals

IN BOARD/OUT BOARD TRANSOM TIE-DOWNS

- 2" x 4' - 1,200#
- Over-center lock buckle
- 2 pack

PART #	MFG #	COLOR	U/M		
266032	06100	BLACK	PR	19.95	G



TRANSOM/BOW U BOLT STYLE

PART #	MFG #	COLOR	U/M		
266035	53816	STEEL	EA	11.95	G



TRANSOM/BOW

- Stainless steel
- 3/8" x 3" threaded rod
- Nuts and washers included
- Sold each, bulk

PART #	MFG #	COLOR	U/M		
266034	53909	STEEL	EA	5.95	G



ERICKSON TIE DOWNS

ROPE RATCHET TIE DOWNS

- The Rope Ratchet's construction lets you secure a wide variety of loads quickly and easily
- With Rope Ratchet, you simply attach the two hooks and pull the loose end of the rope to the secure tightness you need
- With Rope Ratchet tie-downs, you never have to worry about stretching, snapping back, or loosening
- Your load stays secure because the rope stays locked in place with every pull until you release it by pushing the convenient thumb lever
- Display packaged
- 3 sizes



SIZE	LOAD LIMIT	PART #	MFG #	U/M		
1/4" x 8'	150#	EK01800	01800	EA	13.60	G
3/8" x 8'	250#	EK01801	01801	EA	20.20	G
1/2" x 12'	500#	EK01805	01805	EA	43.75	G



LEVER ACTION - INDUSTRIAL CARGO BARS

PART #	MFG #	DESC.	U/M		
EK8906	08906	88" - 103"	EA	42.45	B
EK8907	08907	60" - 75"	EA	39.95	B

RATCHETING - INDUSTRIAL CARGO BAR

PART #	MFG #	DESC.	U/M		
EK8909	08909	81" - 105"	EA	119.95	B



- tires & wheels
- axles, hubs & springs
- tongue accessories
- hitches
- electrical
- brake parts
- trailer hardware
- locks & pins
- towing & loading
- tie downs
- tools
- chemicals

TRAILER

ERICKSON TIE DOWNS



~ E-TRACK ACCESSORIES ~

- tires & wheels
- axles, hubs & springs
- tongue accessories
- hitches
- electrical
- brake parts
- trailer hardware
- locks & pins
- towing & loading
- tie downs**
- tools
- chemicals



CAM LOCK LOGISTIC STRAP

- 2" x 10' - 2,000#
- Sold each, packaged

PART #	MFG #	COLOR	U/M		
EK9151	09151	BLUE	EA	19.95	G

3,500 LB RATCHETING LOGISTIC STRAP

PART #	MFG #	DESC.	U/M		
EK9137	09137	2" x 16'	EA	26.90	G



E-TRACK ADJUSTABLE TIRE STRAP

- For standard tires
- Sold each

PART #	MFG #	COLOR	U/M		
EK08314	08314	YELLOW	EA	42.75	G



TIE-OFF

- 2" x 8" - 3,500#
- Sold each, packaged

PART #	MFG #	COLOR	U/M		
EK9143	09143	BLUE	EA	8.65	G



TRAILER



BUYERS TIE DOWNS

RATCHET TIE DOWN WITH J-HOOKS

- (1 ea.) 2" x 27' - 10,000#
- Great for ATVs, snowmobiles, boats, campers, motorcycles, trucks, and more!

PART #	MFG #	COLOR	U/M		
BY12271	RTD12271J	YELLOW	EA	37.95	G



RATCHET TIE DOWNS

- (4 ea.) 1" x 12' - 1,800#
- Great for ATVs, snowmobiles, boats, campers, motorcycles, trucks, and more!

PART #	MFG #	COLOR	U/M		
BY411218	RTD411218	YELLOW	SET OF 4	26.95	G



CAM BUCKLE TIE DOWNS

- (4 ea.) 1" x 6' - 1,200#
- Great for ATVs, snowmobiles, boats, campers, motorcycles, trucks, and more!

PART #	MFG #	COLOR	U/M		
BY41612	CBTD41612	YELLOW	SET OF 4	19.95	G

SPI TIE DOWNS



TIE DOWN STRAPS

- (2 ea.) 1" x 5 1/2' - 2,000#
- 4 colors
- Packaged in pairs for display

PART #	MFG #	COLOR	U/M		
622142	12-140	BLACK	PR	15.95	L
622143	12-140-3	GREEN	PR	15.95	L
622146	12-140-1	RED	PR	15.95	L
622147	12-140-2	BLUE	PR	13.95	L



- tires & wheels
- axles, hubs & springs
- tongue accessories
- hitches
- electrical
- brake parts
- trailer hardware
- locks & pins
- towing & loading
- tie downs**
- tools
- chemicals

TRAILER

TIE DOWNS

PERFORMANCE TOOL TIE DOWNS



- tires & wheels
- axles, hubs & springs
- tongue accessories
- hitches
- electrical
- brake parts
- trailer hardware
- locks & pins
- towing & loading
- tie downs
- tools
- chemicals

2 PIECE 1" X 6' CAM BUCKLE SET

- (2 ea) 1" x 6' - 900#
- 1" wide synthetic webbing
- Die cast cam buckle
- Steel 'S' hooks, coated
- Clamshell packaged



PART #	MFG #	COLOR	U/M		
W1419	W1419	YELLOW	PR	14.60	G

2 PIECE RATCHETING TIE DOWN

- 1" wide synthetic webbing
- 4' - 15' adjustable length
- 500# breaking strength
- Clamshell packaged
- 2 pack



PART #	MFG #	COLOR	U/M		
W1424	W1424	RED	PR	9.60	G

RATCHETING TIE DOWN

- 1" wide synthetic webbing
- 4' - 15' adjustable length
- 1500# breaking strength
- Clamshell packaged
- Sold each



PART #	MFG #	COLOR	U/M		
W1425	W1425	YELLOW	PR	8.75	G

4 PIECE RATCHETING TIE DOWN STRAP SET

- (4 ea.) 1" x 15'
- Locking ratchets
- Protective coated hooks
- Easy push button release
- Display packaged
- Set of 4 pieces
- Camo



PART #	MFG #	COLOR	U/M		
W1440	W1440	CAMO	SET OF 4	29.70	G

AUTOMATIC LOCKING TIE DOWNS

- (4 ea.) 1" x 6' - 1,200#
- Woven polyester straps
- Protective coat hooks
- Push button release



PART #	MFG #	COLOR	U/M		
W1446	W1446	BLUE	SET OF 4	25.60	G

TRAILER



TITAN RATCHET TIE DOWNS

- Ratchet tie downs provide super strong holding power & precise tension adjustment
- Stylish Cast Handle Steel handle with padded grip
- Easy to reach release button



444215



444216



444217

PART #	MFG #		DUTY RATING	LOAD CAPACITY	BREAK STRENGTH			
444215	1157100	TITAN RATCHET TIE DOWN 1" x 14' (SINGLE)	STD	600	1800	BLACK	18.94	B
444216	1157200	TITAN RATCHET TIE DOWN 1" x 6' (2-PACK)	STD	600	1800	BLACK	29.16	B
444217	1157300	TITAN RATCHET TIE DOWN 1" x 10' (4-PACK)	STD	600	1800	BLACK	52.44	B



TITAN MAXGRIP RATCHET TIE DOWNS

- Full open grip handle, fits any sized hand comfortably
- Cast aluminum handled ratchets
- Curved release button for ease of use



444218



444219



444220

PART #	MFG #		DUTY RATING	LOAD CAPACITY	BREAK STRENGTH			
444218	1158300	TITAN MAXGRIP RATCHET TIE DOWN 1" x 14' (SINGLE)	HEAVY	1000	3000	BLACK	20.40	B
444219	1158400	TITAN MAXGRIP RATCHET TIE DOWN 1" x 14' (2-PACK)	HEAVY	1000	3000	BLACK	32.93	B
444220	1158500	TITAN MAXGRIP RATCHET TIE DOWN 1" x 14' (4-PACK)	HEAVY	1000	3000	BLACK	59.75	B



CAMBUCKLE TIE DOWNS

- Vinyl coated S-hooks protect boats finish
- Provides super strong holding power
- Some models available with stainless steel housing



444221



444222

PART #	MFG #		DUTY RATING	LOAD CAPACITY	BREAK STRENGTH			
444221	2060166	CAMBUCKLE TIE DOWN W/HOOKS - (BOW) 1" x 36" STAINLESS STEEL (2-PACK)	LIGHT	300	900	BLACK	24.04	B
444222	2060066	CAMBUCKLE TIE DOWN W/HOOKS - (BOW) 1" x 36" ZINC (2-PACK)	STD	400	1200	BLACK	15.56	B



RATCHET TIE DOWN W/PADDED HANDLE

- Ratchet w/Padded Handle Tie Down
- 1" x 6',
- 1,800 lbs. - Break Strength



PART #	MFG #		DUTY RATING	LOAD CAPACITY	BREAK STRENGTH			
444239	1152101	RATCHET TIE DOWN W/PADDED HANDLE - 1" x 6' (2-PACK)	STD	600	1800	ORANGE	23.83	B

tires & wheels
axles, hubs & springs
tongue accessories
hitches
electrical
brake parts
trailer hardware
locks & pins
towing & loading
tie downs
tools
chemicals

TRAILER

TIE DOWNS

- tires & wheels
- axles, hubs & springs
- tongue accessories
- hitches
- electrical
- brake parts
- trailer hardware
- locks & pins
- towing & loading
- tie downs
- tools
- chemicals



CAMBUCKLE TRANSOM TIE DOWNS

- Locks in place to eliminate slippage
- Protective housing prevents scratches
- Some models available with stainless steel housing



PART #	MFG #		DUTY RATING	LOAD CAPACITY	BREAK STRENGTH			
444224	2060666	SURELOK CAMBUCKLE TIE DOWN - (TRANSOM) 2" x 48" STAINLESS STEEL (2-PACK)	LIGHT	333	1000	BLACK	62.34	B
444225	2060466	SURELOK CAMBUCKLE TIE DOWN - (TRANSOM) 2" x 24" ZINC (2-PACK)	HEAVY	833	2500	BLACK	34.29	B
444226	2060766	SURELOK CAMBUCKLE TIE DOWN - (TRANSOM) 2" x 48" ZINC (SINGLE)	HEAVY	833	2500	BLACK	17.85	B



RETRACTABLE TRANSOM TIE DOWNS

- Retractable Transom Ratchets
- Strap retracts for easy storage and no tangling
- Easy bolt on function (Hardware included)
- Some models available with stainless steel housing



PART #	MFG #		DUTY RATING	LOAD CAPACITY	BREAK STRENGTH			
444227	2061865	RETRACTABLE TIE DOWN - (TRANSOM) 2" x 43" STAINLESS STEEL (SINGLE)	STD	600	1800	BLACK	60.98	B
444228	2060266	RETRACTABLE TIE DOWN - (TRANSOM) 2" x 43" STAINLESS STEEL (2-PACK)	STD	600	1800	BLACK	129.71	B
444229	2061766	RETRACTABLE TIE DOWN - (TRANSOM) 2" x 43" ZINC (SINGLE)	HEAVY	833	2500	BLACK	30.86	B
444230	2060366	RETRACTABLE TIE DOWN - (TRANSOM) 2" x 43" ZINC (2-PACK)	HEAVY	833	2500	BLACK	74.21	B

TRAILER



RETRACTABLE RATCHET TIE DOWNS

- Strap retracts for easy storage and no tangling
- Easy bolt on function (Hardware included)
- Some models available with stainless steel housing



PART #	MFG #		DUTY RATING	LOAD CAPACITY	BREAK STRENGTH			
444240	1153500	RETRACTABLE RATCHET TIE DOWN - 1" x 6' (2-PACK)	STD	400	1200	CAMO	34.26	B
444241	1151801	RETRACTABLE RATCHET TIE DOWN - 1" x 6' MOTORCYCLE (2-PACK)	STD	500	1500	BLACK	34.30	B
444242	1154000	RETRACTABLE RATCHET TIE DOWN - 2" x 10' (SINGLE)	HEAVY	1100	3300	BLACK	34.30	B



STAINLESS STEEL GUNWALE MAX GRIP RATCHET TIE DOWNS

- Gunwale Ratchets
- Vinyl coated J-hooks protect boats finish
- Provides super strong holding power



PART #	MFG #		DUTY RATING	LOAD CAPACITY	BREAK STRENGTH			
444231	2060866	MAX GRIP RATCHET - (GUNWALE) 2" x 10' STAINLESS STEEL (SINGLE)	LIGHT	333	1000	BLACK	46.65	B
444232	2060966	MAX GRIP RATCHET - (GUNWALE) 2" x 13' STAINLESS STEEL (SINGLE)	STD	400	1200	BLACK	47.53	B



ZINC GUNWALE MAX GRIP RATCHET TIE DOWNS

- Gunwale Ratchets
- Vinyl coated J-hooks protect boats finish
- Provides super strong holding power



PART #	MFG #		DUTY RATING	LOAD CAPACITY	BREAK STRENGTH			
444235	2061266	MAX GRIP RATCHET - (GUNWALE) 2" x 10' ZINC (SINGLE)	HEAVY	833	2500	BLACK	29.12	B
444236	2061366	MAX GRIP RATCHET - (GUNWALE) 2" x 13' ZINC (SINGLE)	HEAVY	833	2500	BLACK	29.75	B
444237	2061466	MAX GRIP RATCHET - (GUNWALE) 2" x 16' ZINC (SINGLE)	HEAVY	833	2500	BLACK	30.59	B
444238	2061566	MAX GRIP RATCHET - (GUNWALE) 2" x 20' ZINC (SINGLE)	HEAVY	833	2500	BLACK	31.85	B



RATCHET TIE DOWNS

- Versatile ratchet tie downs
- Made of power web plus webbing with a 900 pound capacity
- Easy to use, just attach and pump the handle
- Ratchet tightens down with vise like gripping power
- Perfect for all your trailering needs



444243



444244



444245

PART #	MFG #		DUTY RATING	LOAD CAPACITY	BREAK STRENGTH			
444243	1169900	RATCHET TIE DOWN (ENDLESS) 1" x 12' (SINGLE)	LIGHT	300	900	RED	11.62	B
444244	1170000	RATCHET TIE DOWN W/HOOKS - 1" x 13' (Single)	LIGHT	300	900	RED	13.55	B
444245	1227000	RATCHET TIE DOWN 1" 10' (SINGLE)	LIGHT	300	900	RED	9.75	B

- tires & wheels
- axles, hubs & springs
- tongue accessories
- hitches
- electrical
- brake parts
- trailer hardware
- locks & pins
- towing & loading
- tie downs**
- tools
- chemicals

TRAILER

TIE DOWNS



RATCHET TIE DOWNS

- Versatile ratchet tie downs
- Easy to use, just attach and pump the handle
- Ratchet tightens down with vise like gripping power
- Perfect for all your trailering needs



PART #	MFG #		DUTY RATING	LOAD CAPACITY	BREAK STRENGTH			
444247	1152301	RATCHET TIE DOWN W/HOOKS - 1" x 6' (2-PACK)	STD	500	1500	CAMO	23.21	B
444248	1170200	RATCHET TIE DOWN - 1" x 6' (2-PACK)	STD	500	1500	BLUE	23.21	B
444249	1170500	RATCHET TIE DOWN - 1" x 14' (SINGLE)	STD	500	1500	BLUE	15.75	B
444250	9010500	RATCHET TIE DOWN - 1" x 10' (4-PACK)	STD	500	1500	RED	34.02	B



PART #	MFG #		DUTY RATING	LOAD CAPACITY	BREAK STRENGTH			
444251	1151601	RATCHET TIE DOWN - 1-1/4" x 10' (2-PACK)	HEAVY	1100	3300	YELLOW	33.33	B
444252	1160400	RATCHET TIE DOWN W/REFLECTIVE WEBBING (ATV) - 1" x 12' (4-PACK)	HEAVY	1100	3300	BLACK	44.46	B
444253	1151701	RATCHET TIE DOWN - 1-1/2" x 15' (SINGLE)	SUPER	1830	5500	YELLOW	31.67	B
444254	1152500	RATCHET TIE DOWN W/HOOKS 2" x 25' (SINGLE)	SUPER	3330	10000	YELLOW	43.30	B



SURELOCK CAM BUCKLE TIE DOWN W/HOOKS

- Will not damage cargo
- Leverage doubles the hold down force of a cam buckle
- Great choice for motorcycle or ATV Tie Down



PART #	MFG #		DUTY RATING	LOAD CAPACITY	BREAK STRENGTH			
444264	1152201	SURELOK CAMBUCKLE TIE DOWN W/HOOKS - 1" x 6' (2-PACK)	STD	500	1500		24.47	B

TRAILER

- tires & wheels
- axles, hubs & springs
- tongue accessories
- hitches
- electrical
- brake parts
- trailer hardware
- locks & pins
- towing & loading
- tie downs
- tools
- chemicals



CAM BUCKLE TIE DOWN W/HOOKS

- Will not damage cargo
- Leverage doubles the hold down force of a cam buckle
- Great choice for motorcycle or ATV Tie Down



444258



444260



444262

PART #	MFG #		DUTY RATING	LOAD CAPACITY	BREAK STRENGTH	
444258	1033300	CAMBUCKLE TIE DOWN W/HOOKS - 1" x 10' (SINGLE)	LIGHT	300	900	8.97 B
444260	1152401	CAMBUCKLE TIE DOWN W/HOOKS - 1" x 6' (2-PACK)	STD	400	1200	22.97 B
444262	1034400	CAMBUCKLE TIE DOWN W/HOOKS - 1" x 12' (SINGLE)	STD	400	1200	15.43 B



FAT BUNGEE

- Won't damage or dig into your cargo
- Extra wide, strong and secure
- Coated steel hooks are stronger than conventional hooks
- Rotating Fat Straps rotate 360 degrees for easy adjustment
- Reflective Fat Straps increase visibility for all drivers



PART #	MFG #		
444266	9412000	20" FAT BUNGEE	3.30 B
444267	9413000	30" FAT BUNGEE	3.72 B
444268	9414500	45" FAT BUNGEE	4.39 B
444269	9414900	10"-45" ADJUSTABLE FAT STRAP BUNGEE	5.78 B

- Designed to secure objects to the vehicle
- Made from rubber cords for superior strength
- Coated steel hooks are stronger than conventional hooks
- Extra wide strap provides strong and secure hold
- It is color coded by length for convenient selection



PART #	MFG #		
444271	9002600	18pc. FAT STRAP ASSORT 3-15", 2-18", 2-20", 2-24", 2-30", 2-32", 1-ORING, 4 MINI JAR PACK	24.02 B

- tires & wheels
- axles, hubs & springs
- tongue accessories
- hitches
- electrical
- brake parts
- trailer hardware
- locks & pins
- towing & loading
- tie downs
- tools
- chemicals

TRAILER

TIE DOWNS

- tires & wheels
- axles, hubs & springs
- tongue accessories
- hitches
- electrical
- brake parts
- trailer hardware
- locks & pins
- towing & loading
- tie downs
- tools
- chemicals



ADJUSTABLE STRAP FAT BUNGEE

- Won't damage or dig into your cargo
- Extra wide, strong and secure
- Extra wide, strong and secure
- Coated steel hooks are stronger than conventional hooks
- Rotating Fat Straps rotate 360 degrees for easy adjustment
- Reflective Fat Straps increase visibility for all drivers

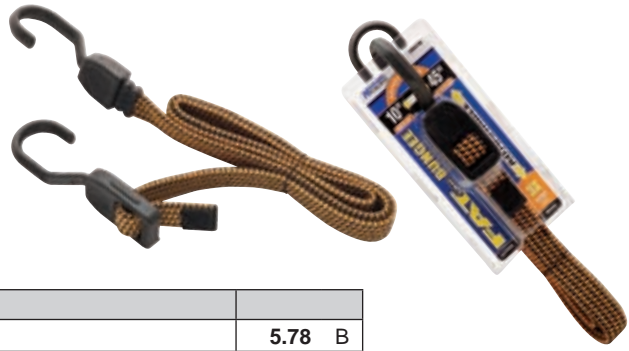

PART #	MFG #		
444269	9414900	10"-45" ADJUSTABLE FAT STRAP BUNGEE	5.78 B



BUNGEE CORDS

Coated steel hooks are 3X stronger than conventional hooks
 Won't bend, break, scratch or mar
 Color coded hooks for convenient selection
 Engineered to withstand even the harshest outdoor elements



PART #	MFG #		
444272	2902000	12" TRIPLE STRENGTH BUNGEE BLUE	4.05 B
444273	2902100	18" TRIPLE STRENGTH BUNGEE RED	3.85 B
444274	2902200	24" TRIPLE STRENGTH BUNGEE GREEN	4.81 B
444275	9302400	24" TRIPLE STRENGTH BUNGEE RED	2.91 B
444276	9303200	32" TRIPLE STRENGTH BUNGEE GREEN	3.29 B
444277	2902300	32" TRIPLE STRENGTH BUNGEE PURPLE	5.35 B
444278	2902400	32" TRIPLE STRENGTH BUNGEE BLACK	5.08 B
444279	9304000	40" TRIPLE STRENGTH BUNGEE YELLOW	3.29 B
444280	9305200	52" TRIPLE STRENGTH BUNGEE ORANGE	4.59 B
444281	2902500	TRIPLE STRENGTH ASSORTMENT (10pc.) 2-12", 2-18", 2-24" & 4-32"	22.26 B
444282	2902600	TRIPLE STRENGTH ASSORTMENT (5pc.) 1-12", 1-18", 1-24" & 2-32"	11.93 B

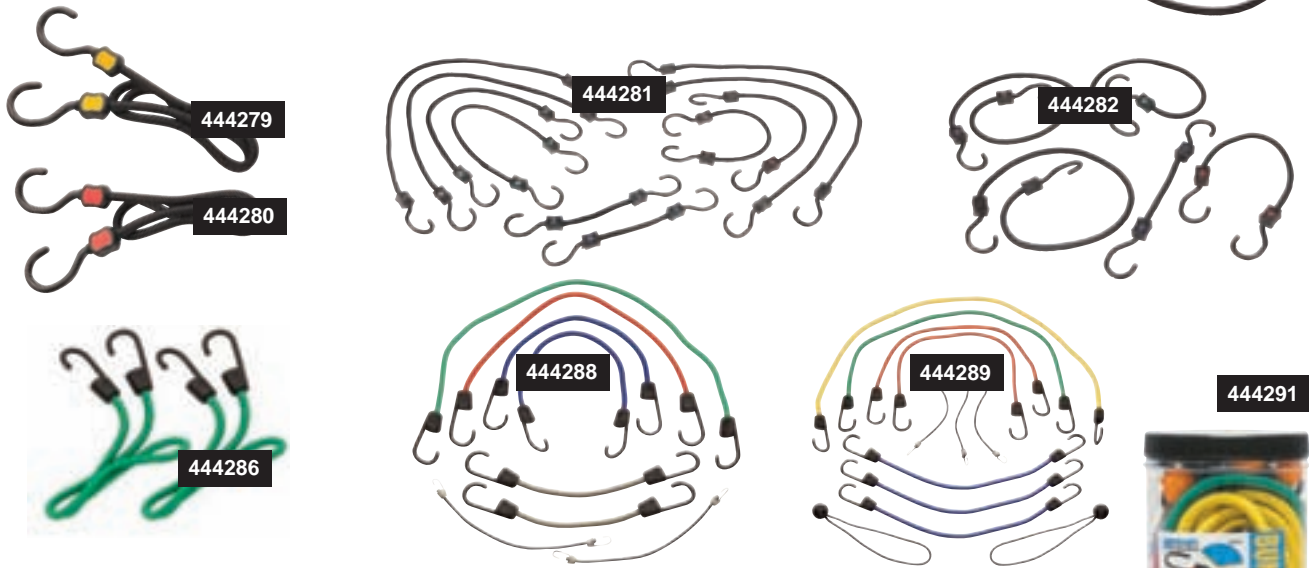

PART #	MFG #		
444285	9402400	1pc. BUNGEE 24"	1.92 B
444286	9203200	2pc. BUNGEE 2-32" x 8mm	2.70 B
444288	9009600	8pc. BUNGEE ASSORTMENT 2-12", 2-18", 1-24", 1-32", 2 MINI	10.70 B
444289	9008600	12pc. BUNGEE ASSORTMENT 2-12", 2-18", 1-24", 1-32", 2 MINI	12.20 B
444291	9008400	24pc. BUNGEE CORD SET 6-18", 4-24", 2-32", 2-40", 4 CANOPY TIES JAR PACK	22.50 B



TRAILER



TOOLS



TOOLS

- tires & wheels
- axles, hubs & springs
- tongue accessories
- hitches
- electrical
- brake parts
- trailer hardware
- locks & pins
- towing & loading
- tie downs
- tools
- chemicals

MOTION PRO PROFESSIONAL TIRE PRESSURE GAUGES

- Custom gauge faces in Motion Pro signature blue and black
- High quality liquid filled 2.5 in. dial gauge with bleeder vent at top
- Custom protective boot with vent hole access
- Accurate to plus/minus 1.5 percent of maximum gauge reading
- Anodized 6061-T6 body with pressure relief valve
- High pressure hose with dual swivels and brass ball type air chuck



DESCRIPTION	PART #			
0-30 psi, MX & Off-Road	142193	96.99	E	
0-60 psi, Street	142316	96.99	E	



VALVE STEM SEAL INSTALL TOOL SET 4 MM, 4.5 MM, 5 MM & 5.5MM

- Four common sizes for use on most modern off-road motorcycles as well as ATVs
- Properly aligns valve stem seal to valve guide so seal snaps on straight every time
- Provides for quick and easy installation of valve stem seals on multi valve cylinders
- Contoured design in bottom of handle cradles and protects the delicate inner lip of the valve stem seal while directing tool force to the sturdy outer rim
- Slim profile allows easy access to valve guides even on modern compact heads with deep lifter bores
- Rounded tip will not damage inner lip of valve stem seal or valve guide bore
- Anodized aluminum handles with stainless steel pilot shafts
- Limited lifetime warranty



DESCRIPTION	PART #			
Set	144156	38.99	E	
5.5 mm	144153	11.99	E	



TMV TIRE PRESSURE GAUGE GRAY



631542 11.95 B

WHEEL BEARING REMOVER 8 PIECE METRIC SET

- 8 piece metric set includes large and small drivers, 10mm, 12mm, 15mm, 17mm, 20mm, and 25mm removers
- Dependable split collet design
- Metric sizes to allow use with metric applications
- Also available as individual components



142204 86.99 E

REPLACEMENT BEARING REMOVERS

10 mm	142197	5.18	E
12 mm	142198	6.47	E
15 mm	142199	8.65	E
17 mm	142203	8.93	E
20 mm	142201	10.47	E
25 mm	142202	12.88	E



TRAILER

DIGITAL TIRE PRESSURE GAUGE 0-60 PSI

- High precision accurate to +/- 0.6 psi
- Precise digital readout to 0.1 psi
- Continuous pressure reading, no need to reset when activating bleed valve
- Four selectable scales (PSI, BAR, KG-CM2, kPa)
- Large easy to read display with back light for low light applications
- Billet aluminum trapezoid body
- High flow push button bleeder valve for precise pressure adjustment
- 18 inch long high pressure hose with dual swivels and brass ball type air chuck
- Rubber anti-shock protective boot
- Battery powered (1000 tests) with battery strength indicator
- Auto off to extend the battery life
- Battery included
- One year limited warranty



142373 98.99 E

MOTION PRO AIR GAUGE HOLDER

- Aluminum Gauge holder designed for use with Motion Pro Professional and Digital Tire Gauges
- Magnet on back allows for quick mounting to any metal surface or can be used without magnet for permanent mounting
- Eye catching number plate graphics with space for personalized race numbers

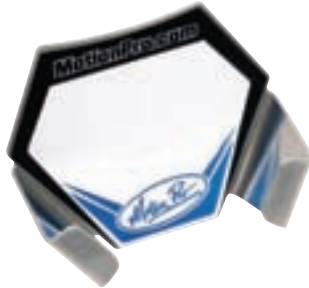

142379 19.99 E

BRONCO TIRE INFLATOR KIT

- Kit Includes:
- 6 Tire Plugs
 - 1 Probe
 - 1 T-handle Tool
 - 3 16 Gr. oz. Cartridges
 - 1 Regulator
 - 1 Black Carrying Bag



62-12058 23.95 L



TIRE REPAIR KIT

- Everything you need to repair and inflate multiple ATV tires
- Packed conveniently in our handy storage pouch
- Includes:
 - (3) CO2 cartridges (1 to 2 cartridges will fill most ATV tires)
 - Regulator/adaptor tool
 - (5) 4" tire seals
 - Tire roughing tool plus installation tool



252218 28.73 B



FLAT PACK

- Includes all of the tools a rider will need to fix up to 10 ATV flats
- Tools are secured inside a handy, easy-to-use pump
- Easily straps to ATV rack or stores inside gear box
- Patented design



KP89500 40.23 B



ATV TIRE GAUGE 1-20 PSI

Marked in 1/2 lb. increments and graduated from 1-20 lbs. Has a four sided calibrated bar provided with an air release and an offset chuck.



EM68520 4.95 L

ATV TIRE GAUGE 0-8 PSI

Pocket size (2 1/2") low pressure tire gauge. Marked in 1/2 lb. increments, accurately measures tire pressure up to 8 lbs.



EM68508 3.95 L

- tires & wheels
- axles, hubs & springs
- tongue accessories
- hitches
- electrical
- brake parts
- trailer hardware
- locks & pins
- towing & loading
- tie downs
- tools
- chemicals

TRAILER

- tires & wheels
- axles, hubs & springs
- tongue accessories
- hitches
- electrical
- brake parts
- trailer hardware
- locks & pins
- towing & loading
- tie downs
- tools
- chemicals

35 PC TIRE HARDWARE KIT

- 4pcs chrome hex valve caps.
- 4pcs high temp valve cores.
- 4pcs plastic valve stems.
- 1pc 4 way valve tool.
- 1pc tire pressure gauge.
- 1pc rubber cement tube.
- 1pc metal scuffer.
- 10pcs round patches.
- 3pcs tubeless tire repair plugs.
- 1pc reamer.
- 1pc plugger.

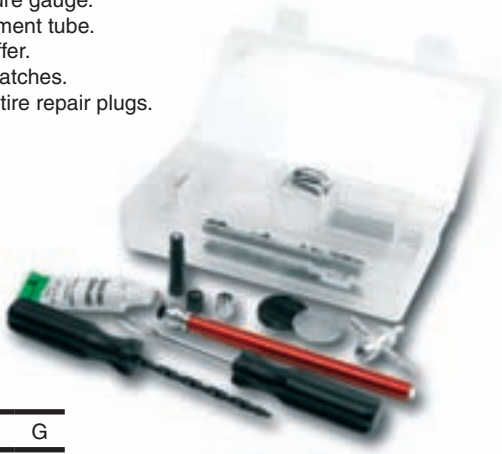

260001 13.95 G

TIRE REPAIR & MAINTENANCE KIT

- 8 pcs chrome hex valve caps.
- 8 pcs high temp valve cores.
- 2 pcs each long rubber tire valves and short rubber tire valves.
- 8 pcs each plastic valve caps and plastic valve extensions.
- 1 pc each valve core remover, tire chuck and dual foot tire pressure gauge.
- 20 pcs tubeless tire repair plugs.
- 1 pc each ergonomic grip reamer and ergonomic grip plugger.
- For patching, 1 tube rubber cement, 1pc metal scuffer, 2pcs rectangular patches, 2 pcs large round patches and 15pcs small round patches.



260000 31.95 G

5 PACK TUBELESS TIRE REPAIR PLUGS

4" long tire repair plugs.



260004 1.95 G

30 PACK TUBELESS TIRE REPAIR PLUGS

4" long tire repair plugs.



260003 5.95 G

TRAILER

RUBBER CEMENT

- For use with tire patches.
- many uses around the house and garage.



260005 1.95 G

2PC CAM BUCKLE SET (1" X 6')

- 1" x 6' cam buckle set
- 900 lb. break strength (300 lb. safe working load)
- 1" wide synthetic webbing
- Die cast cam buckle
- Steel "S" hooks
- Yellow
- 2-pack
- Display packaged



W1419 14.60 G

MINI DIAL TIRE PRESSURE GAUGE

- 1 to 60 PSI range
- Measures 1 one pound increments
- 1" easy to read white face dial
- Proper tire maintenance saves money by improving fuel economy and reducing tire wear
- Ideal for cars, trucks, SUV's, bicycles and more



260069 4.95 G

DIGITAL TIRE PRESSURE GAUGE

- Backlit display and convenient lighted tip.
- Triple function display P.S.I., BAR, and KPa.
- Auto off feature: Automatically shuts off in 30 seconds when not in use



260070 13.95 G

12V COMPACT TIRE INFLATOR

- Plugs into 12-Volt Accessory Outlet
- Includes Two Nozzle Adapters and Sport Needle
- Great for Tires, Toys and Sporting Goods
- 10 Ft. Power Cord
- 18 in. Hose Length with Universal Valve Adapter
- Handy on/off switch
- Easy to read pressure gauge
- High output 250 PSI motor



260006 18.95 G

MINI TIRE INFLATOR

- 100 PSI high pressure air compressor inflates standard car tire in under 8 minutes.
- Compact size for easy storage with convenient storage compartment.
- 9' power cord with fused 12V power plug.
- 12V power cord plugs into vehicle power outlet.
- Built in dial pressure gauge.
- Accessories include sports ball needle, raft and toy inflator nozzles and Presta valve adapter.
- 17.5" high pressure hose.



260007 23.95 G

TIRE INFLATOR W/LED

- 100 PSI high pressure air compressor.
- Large easy to read built in dial pressure gauge.
- 3 Super bright LEDs for night time emergencies.
- 15" high pressure hose with screw on chuck.
- 10' power cord with fused 12V power plug.
- 12V power cord plugs into vehicle power outlet.
- Inflates standard car tire in under 4 minutes (Performance based upon 175/70 R13 tire to 30 PSI).
- Accessories include sports ball needle, raft and toy inflator nozzles and Presta valve adapter.



260008 32.95 G

4 WAY FOLDING LUG WRENCH

- SAE heavy duty drop forged steel
- Chrome plated to resist corrosion
- SAE and metric sizes: 11/16", 3/4", 13/16" and 7/8", 17mm, 19mm, 21mm and 23mm
- Folds down for compact storage



260089 17.95 G

- tires & wheels
- axles, hubs & springs
- tongue accessories
- hitches
- electrical
- brake parts
- trailer hardware
- locks & pins
- towing & loading
- tie downs
- tools
- chemicals

TRAILER

- tires & wheels
- axles, hubs & springs
- tongue accessories
- hitches
- electrical
- brake parts
- trailer hardware
- locks & pins
- towing & loading
- tie downs
- tools
- chemicals

5 GALLON PORTABLE AIR TANK

W/COLOR DISPLAY BOX

- 125 PSI Maximum
- Light-Weight, portable with handle for easy transport
- Safety pressure bypass valve with manual override
- On/Off air adjustment dial
- Industrial grade air hose with standard tire air chuck
- Hi-Viz color for added visibility



W10005 53.95 G

11 GALLON PORTABLE AIR TANK

W/COLOR DISPLAY BOX

- 125 PSI Maximum
- Light-Weight, portable with handle for easy transport
- Safety pressure bypass valve with manual override
- On/Off air adjustment dial
- Industrial grade air hose with standard tire air chuck
- Hi-Viz color for added visibility



W10011 81.95 G

2 TON JACK STANDS (1 PAIR)

- Ratchet style for easy adjustments
- 10-3/8" to 16-3/8" range



260086 35.95 G

2 TON HYDRAULIC BOTTLE JACK

- Heavy duty base.
- Adjustable top screws.



260074 20.95 G

2.5 TON JACK

- 5 to 15-1/2" lift range.
- Swivel casters for easy positioning.
- Durable flanged steel frame.
- Great for cars and light duty trucks.



260075 78.95 G

MULTI-PURPOSE LIFT

- 1,500 lb capacity
- Lift range 4-1/2" to 16-1/2"
- Tow safety bolts ensure stability
- Three position locking levers
- Non-slip rubber foot pedal
- Easy to roll steel swivel casters



W41035 198.95 B

7PC CORDLESS GREASE GUN ACCESS.

- For all types of grease lubrication applications.
- 1 press on 90 degree angle tip.
- One straight extension tip.
- One 12" hose extension.
- One slide on 90 degree coupler.
- One rubber tipped nozzle.
- One needle nozzle.
- One 360 degree coupler.



260099 41.95 G

12" GREASE GUN FLEX HOSE

- 12" hose for hard to reach areas.
- For use with hand and air powered grease guns.
- Size: 12"
- Working Pressure (PSI): 4,500
- Burst Pressure (PSI): 12,000
- NPT (IN): 1/8"



260102 4.95 G

18" GREASE GUN FLEX HOSE

- 18" hose for hard to reach areas.
- For use with hand and air powered grease guns.
- Size: 18"
- Working Pressure (PSI): 4,500
- Burst Pressure (PSI): 10,000
- NPT (IN): 1/8"



260103 4.95 G

GREASE GUN COUPLER

- Fits most hand operated grease guns.
- Maximum Working Pressure (PSI): 3,000
- Burst Pressure (PSI): 6,000
- NPT (IN): 1/8"



260104 1.95 G



GREASE INJECTOR NEEDLE

- 18 ga. Tempered stainless steel
- Can be easily inserted under or through bearing seals
- Includes protective cover
- WARNING: Maximum working pressure - 3,000 PSI. For use with hand grease guns only



260105 1.95 G



4" GREASE GUN NDL. NOSE ADAPTER

- Dispenses a fine line of grease to confined areas
- Includes large and small sleeve to fit standard couplers
- Great for 4WD (CV) universal joints
- WARNING : Maximum working pressure - 3,000 PSI. For use with hand grease guns only



260106 6.95 G



NEEDLE NOSE ADAPTER

- Dispenses a fine line of grease to confined areas
- Includes large and small sleeve to fit standard couplers
- Great for 4WD (CV) universal joints
- WARNING: Maximum working pressure - 3,000 PSI
- For use with hand grease guns only



260107 2.95 G



WALL MOUNTED GREASE GUN HOLDER

- Wall mount design
- Center latch locks
- Corrosion resistant finish



260108 5.95 G

BEARING PACKER

- Quickly and thoroughly packs bearings with new grease while forcing out old grease all in one easy operation.
- Accommodates most roller and ball bearings.



260101 6.95 G



SUCTION GUN

- Professional quality heavy duty construction and chrome plated finish for long service life.
- Perfect for transmissions, differentials, gear cases, lower units, crankcases, etc.
- Zinc die cast head cap.
- No priming necessary.
- 12" flexible hose.
- Knurled thick wall barrel for secure grip.
- 1 pint capacity.



260100 10.95 G



- tires & wheels
- axles, hubs & springs
- tongue accessories
- hitches
- electrical
- brake parts
- trailer hardware
- locks & pins
- towing & loading
- tie downs
- tools
- chemicals

TRAILER

TOOLS

- tires & wheels
- axles, hubs & springs
- tongue accessories
- hitches
- electrical
- brake parts
- trailer hardware
- locks & pins
- towing & loading
- tie downs
- tools
- chemicals

MINI GREASE GUN W/GREASE

- Heavy duty construction.
- "Pistol Grip" action for easy use in tight spaces.
- Vented zinc die cast head cap.
- Positive lock for easy filling.
- Air bleeder valve eliminates air lock.
- Uses 3oz grease cartridge (included).



260067 14.95 G



PRO PISTOL GRIP GREASE GUN

- Professional quality heavy duty construction and chrome plated finish for long service life.
- Pistol grip action for easy use.
- Vented zinc die cast head cap.
- Positive lock for easy filling.
- Air bleeder valve eliminates air lock.
- 2 Way filling: standard 14 oz. grease cartridge or bulk.
- Comfort grip lever handle.

260066 18.95 G



WHITE LITHIUM GREASE

- Includes zinc additives for a clean, white color
- Ideal for general home, shop, marine, snowmobile and industrial applications
- Provides superior performance and protection in most weather and temperature conditions



DESCRIPTION	QTY/CS	PART #	MFG #	
1 lb Resealable Tub	12	LB11350	11350	8.40 G
14 oz Cartridge	10	LB11354	11354	8.40 G

2-PACK 3 OZ MULTI PURPOSE

- Multi purpose lithium based grease is designed for light duty applications which require extended lubrication.
- For light duty automotive, industrial, agricultural or commercial equipment.
- Smooth consistency, water resistant and extremely stable.
- Use on springs, water pumps, bearings, chassis fittings and any general lubrication projects.



260068 5.95 G



MIDGET GREASE GUN KIT

- The ideal tool for the do-it-yourselfer
- Includes one midget gun and one 3 oz. cartridge of multi-purpose grease
- 2 way loading coupler has ball check to prevent leakage



PART #	MFG #	
1727	30-192	22.15 G

LEVER ACTION GREASE GUN

- Three way loading
- Heavy duty performance
- Display carton packaging
- Uses 14 oz. cartridge
- Zinc plated for maximum rust and corrosion resistance



PART #	MFG #	
LB11155	30-465	28.95 G



PRO GREASE GUN

- Professional quality heavy duty construction and chrome plated finish for long service life
- Short stroke "lever action" for easy use in tight spaces
- Vented zinc die cast head cap
- Positive lock for easy filling
- Air bleeder valve eliminates air lock
- Knurled thick wall barrel for secure grip
- Comfort grip lever handle
- Uses standard 14 oz. grease cartridge

PART #	MFG #	
W54202	W54202	17.95 G



12" FLEXIBLE HOSE

This grease gun hose features steel 1/8" NPT male fittings on each end. Good for up to 3,000 PSI recommended working pressure. 12,000 PSI burst pressure. This hose is intended for use on hand-operated grease guns. Flexible whip.



PART #	MFG #	
LB11825	10-212	7.50 G



15 QUART DRAIN CONTAINER

- Large capacity holds multiple oil changes
- Handle and spout for easy carrying and pouring control
- Built-in groove to drain filter



232114 17.95 G

LESS MESS DRAIN PAN

- Extended profile catches full fluid flow
- 11 quart capacity for less spilling
- Built-in filter drain stand



232006 10.95 G

TRAILER

40" PLASTIC CREEPER W/6 CASTERS

The 40" Plastic Creeper w/6 Casters is made from molded plastic that is contoured to fit nearly anyone's body. This product has dipped down areas for your shoulders. It's incredibly light at only 10.5 pounds. Easily stores on the wall.



260090 51.95 G

2 TON POWER PULLER

- 2 ton pull capacity (rolling)/ 1 ton lift capacity
- Drop forged steel safety hooks
- Automatic notch at a time release for maximum safety
- Aircraft cable
- 12 foot cable



W4000 43.50 G

OIL EXTRACTOR - 1 CHAMBER

Oil changes are now a snap! Several strokes of the pump create a vacuum that neatly captures up to 6 liters (1.57 gal.) in the sturdy container. Pour spout is included to help empty container. Pump is removable for easy storage.



967295 61.95 E

OIL EXTRACTOR - 3 CHAMBER

Ideal for bigger jobs, this larger capacity oil/fluid extractor makes changing the oil on your 4-stroke PWC, boat, ATV, and more clean and hassle free. Holds up to 15 liters (3.92 gal) in a sturdy portable container. Handle makes for easy transfer to recycling tank. Pump included.



967296 121.95 E

7 QUART DRAIN PAN

- Molded handles and pour spout.
- Easy to use.
- Chemical and solvent resistant, won't rust or corrode.
- 13 1/2" x 11" x 4".



260065 3.95 G

5-GALLON PAIL PUMP

- Pump measures 8 ounces per stroke of pump



930069 37.95 G

MANUAL SIPHON PUMP

- Easy to operate utilizing a large ball type siphon
- This top quality item is similar to the pump included with new heaters



602 3.70 G

BATTERY SIPHON PUMP

- Convenience and quick fill time makes this a tremendously popular item
 - Powered by two "D cell" batteries (not included)
 - Packaged one per header card
 - Our high quality makes this pump an easy "sell-up" to your manual pump customers
- NOT FOR USE WITH GASOLINE

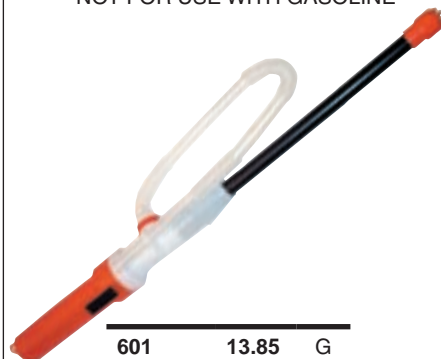

601 13.85 G

SYTHON HOSE

- Siphon liquids fast with the Sython Hose!
- Just shake to start the transfer
- 6 ft. hose



62-07030 12.95 L

- tires & wheels
- axles, hubs & springs
- tongue accessories
- hitches
- electrical
- brake parts
- trailer hardware
- locks & pins
- towing & loading
- tie downs
- tools
- chemicals

TRAILER

- tires & wheels
- axles, hubs & springs
- tongue accessories
- hitches
- electrical
- brake parts
- trailer hardware
- locks & pins
- towing & loading
- tie downs
- tools**
- chemicals

DELUXE AUXILIARY TANK FOR FUEL-INJECTED SYSTEMS

- For use with new fuel-injected models with external fuel pumps as well as standard carburetor type motorcycles
- Upgraded petcock for easier opening and closing
- Built-in fuel return (for fuel-injected models) and breather on cap
- Graduated scale located on the side of bottle allows accurate measurement of fluid volume
- Includes 4 ft. of 1/4 in. fuel line
- Holds up to 2000cc or 1/2 gallon of fluid
- Tank can also be used for refilling transmission oil on some late model MX bikes
- Not designed for fuel storage



142150 81.99 E

COMBO Y-DRIVE WRENCH

- Innovative dual-use design combines 6 tools into one
- 8 mm, 10 mm and 12 mm hex socket
- 4 mm, 5 mm and 8 mm hex drive
- Padded Y-shape for excellent grip and leverage
- Compact design is ideal for trail tool packs
- Chrome-vanadium tool steel
- Limited lifetime warranty



144164 15.50 E

SPINNER T-HANDLE, BIT DRIVER

- Bearing mounted spinner provides faster and easier removal and installation of bolts and nuts
- 5/16 inch hex drive head accepts most common driver bits
- Magnet inside drive head holds drive bits firmly in place
- Narrow drive head profile fits into tight spaces
- Padded grip handle
- Chrome vanadium handle and shaft
- Durable chrome finish on shaft and handle
- Blue anodized spinner with laser engraved Motion Pro logo
- Shaft is 10 inches long
- Bits not included
- Limited lifetime warranty



144171 26.99 E

T-HANDLE BIT DRIVER WITH NO. 1,2,3 METRIC PHILLIPS BITS

- High quality Motion Pro standard bit driver T-handle
- Features 5/16 inch drive heads at end of shaft and at each end of handle
- 5/16 hex drives accept most common driver bits
- Magnet inside driver heads hold drivers firmly in place
- Includes high grade S2 tool steel Phillips bits no. 1, no. 2, and no. 3 made to JIS metric standard
- Narrow drive head profile fits into tight spaces
- Chrome vanadium handle and shaft
- Durable chrome finish on shaft and handle
- Shaft is 10 inches long
- Limited lifetime warranty

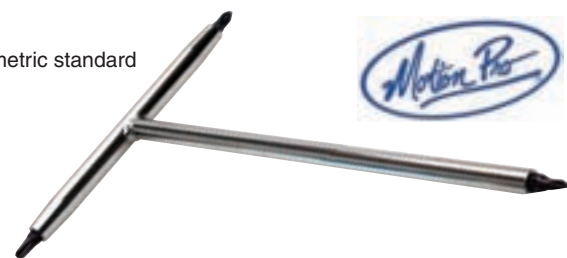

144172 21.99 E

1/4 INCH TRI-DRIVE MINI T-HANDLE KIT

- Use T-Handle drive to tighten/loosen fasteners and shaft drive for quick installation/removal of fasteners
- 1/4 in. drive has a compact 6 inch drive shaft length
- Compact size for use in tight spaces and is easy to carry
- Includes 8, 10, 12 and 13 mm sockets
- Use with 1/4 in. drive sockets, hex drives, crow's foot, swivels, etc.
- Chrome-vanadium tool steel shaft and T-Handle
- Durable nickel pewter finish
- Limited lifetime warranty



142305 18.99 E

DUAL DRIVE L-HANDLES

- Impact resistant ergonomic molded handle reduces hand fatigue
- Use drive side to tighten/loosen fasteners and shaft side for quick installation/removal of fasteners
- Minis are a compact 7 1/2 in. shaft length for tight access and easy transport
- Use with 1/4 in. or 3/8 in. drive sockets, hex drives, crow's foot, swivels, etc.
- One piece chrome-vanadium tool steel shafts
- Durable nickel pewter finish
- Limited lifetime warranty

DESCRIPTION	PART #		
3/8 in. Drive/10 in. Long	678361	13.50	E
1/4 in. Drive/10 in. Long	678363	11.99	E
1/4 in. Drive/7-1/2 in. Long	142283	11.50	E



HEX-PRO™ & STAR-PRO™ PIVOT HEAD WRENCHES

- 180° swivel head with extra long handle for accessing hard to reach places
- Pivot design allows for easy rotation around obstructions
- Pivot design allows you to keep the wrench and fastener engaged when access is limited
- Great time saver
- Heat treated alloy tool steel
- Chrome plated finish
- Includes heavy duty folding canvas storage pouch
- Takes up less storage space than a typical hex key set



DESCRIPTION	PART #		
Hex-Pro® Metric Set (3 mm, 4 mm, 5 mm, 6 mm, 8 mm, 10 mm)	142331	78.99	E
Hex-Pro® SAE Set (3/16", 7/32", 1/4", 5/16", 3/8")	142330	73.99	E
Star-Pro® Torx® Set (T-25, T-27, T-30, T-40, T-45, T-50)	142332	88.99	E

TIPROLIGHT™ TITANIUM WRENCHES

- These super-light wrenches weigh less than one quarter of the weight of standard steel wrenches
- Made from tool-grade titanium alloy
- Extremely lightweight and compact design is perfect for trail tool packs
- Exclusive Motion Pro design for optimized strength and performance
- Titanium alloy will never rust or corrode
- Ergonomic handle
- Laser etched markings for easy identification
- Designed by Motion Pro
- Sets of 4 include heavy-duty nylon tool wrap
- Patented



tires & wheels

axles, hubs & springs

tongue accessories

hitches

electrical

brake parts

trailer hardware

locks & pins

towing & loading

tie downs

tools

chemicals

TRAILER

- tires & wheels
- axles, hubs & springs
- tongue accessories
- hitches
- electrical
- brake parts
- trailer hardware
- locks & pins
- towing & loading
- tie downs
- tools
- chemicals

1/4" DR QR TEARDROP RATCHET

- Quick Release feature for quick and easy socket changes
- Chrome vanadium alloy steel construction for strength and durability
- Polished nickel chrome plated finish resists corrosion
- 72 gear teeth



3 PC 1/4" DR EXTENSION SET

- Chrome vanadium alloy steel construction for strength and durability
- Polished nickel chrome plated finish resists corrosion
- Sizes: 2", 3" and 6"



1/4" DR UNIVERSAL JOINT

- Chrome vanadium alloy steel construction for strength and durability
- Polished nickel chrome plated finish resists corrosion



1/4" F X 3/8" M ADAPTER

- Chrome vanadium alloy steel construction for strength and durability
- Polished nickel chrome plated finish resists corrosion



1/4" DR SOCKET RAIL

- 18" overall length
- Holds 14 sockets



10 PC 1/4" DR 6 PT SAE SOCKET SET

- Recessed edges.
- Socket openings are designed to reduce fastener rounding.
- Chrome vanadium alloy steel construction for strength and durability.
- Polished nickel chrome plated finish resists corrosion.
- Large stamping for quick identification.
- Packaged on plastic slide rail for storage.
- Sizes: 5/32", 3/16", 7/32", 1/4", 9/32", 5/16", 11/32", 3/8", 7/16" and 1/2"



10 PC 1/4" DR 6 PT SAE DW SOCKET SET

- Recessed edges.
- Socket openings are designed to reduce fastener rounding.
- Chrome vanadium alloy steel construction for strength and durability.
- Polished nickel chrome plated finish resists corrosion.
- Large stamping for quick identification.
- Packaged on plastic slide rail for storage.
- Sizes: 5/32", 3/16", 7/32", 1/4", 9/32", 5/16", 11/32", 3/8", 7/16" and 1/2"



10 PC 1/4" DR 6 PT MET SOCKET SET

- Recessed edges.
- Socket openings are designed to reduce fastener rounding.
- Chrome vanadium alloy steel construction for strength and durability.
- Polished nickel chrome plated finish resists corrosion.
- Large stamping for quick identification.
- Packaged on plastic slide rail for storage.
- Sizes: 4, 5, 6, 7, 8, 9, 10, 11, 12, and 13mm.



10 PC 1/4" DR 6 PT MET DW SKT SET

- Recessed edges.
- Socket openings are designed to reduce fastener rounding.
- Chrome vanadium alloy steel construction for strength and durability.
- Polished nickel chrome plated finish resists corrosion.
- Large stamping for quick identification.
- Packaged on plastic slide rail for storage.
- Deep sizes: 4, 5, 6, 7, 8, 9, 10, 11, 12, and 13mm.



260039 21.95 G

36 PC 1/4" DR MECHANIC'S SET

- Socket openings are designed to reduce fastener rounding.
- Chrome vanadium alloy steel construction for strength and durability.
- Polished nickel chrome plated finish resists corrosion.
- Features high torque quick release ratchet. 72 gear teeth for 5 degree sweep.
- Smaller head for tight areas.
- 1pc each spinner handle, universal joint and 3" extension bar.
- 10pc standard SAE socket sizes: 5/32, 3/16, 7/32, 1/4, 9/32, 5/16, 11/32, 3/8, 7/16 and 1/2"
- 6pc Deep SAE socket sizes: 7/32, 1/4, 5/16, 3/8, 7/16 and 1/2".
- 10pc standard MM socket sizes: 4, 5, 6, 7, 8, 9, 10, 11, 12 and 13mm.
- 6pc Deep MM socket sizes: 4, 6, 7, 8, 10 and 12mm.



260040 49.95 G

3/8" DR QR TEARDROP RATCHET

- Quick Release feature for quick and easy socket changes.
- Chrome vanadium alloy steel construction for strength and durability.
- Polished nickel chrome plated finish resists corrosion.
- 72 gear teeth.
- Larger gear teeth for higher torque and added gear strength.



260044 22.95 G

3/8" DR UNIVERSAL JOINT

- Chrome vanadium alloy steel construction for strength and durability
- Polished nickel chrome plated finish resists corrosion



260045 3.95 G

3 PC 3/8" DR WOBBLE EXT SET

- Chrome vanadium alloy steel construction for strength and durability
- Polished nickel chrome plated finish resists corrosion
- Sizes: 1-3/4, 3 and 8"



260047 11.95 G

4 PC 3/8" DR EXTENSION SET

- Chrome vanadium alloy steel construction for strength and durability
- Polished nickel chrome plated finish resists corrosion
- Sizes: 1-3/4, 3, 6 and 8"



260046 11.95 G

3/8" F X 1/2" M ADAPTER

- Chrome vanadium alloy steel construction for strength and durability
- Polished nickel chrome plated finish resists corrosion



260048 2.95 G

3/8" F X 1/4" M ADAPTER

- Chrome vanadium alloy steel construction for strength and durability
- Polished nickel chrome plated finish resists corrosion



260049 2.95 G

- tires & wheels
- axles, hubs & springs
- tongue accessories
- hitches
- electrical
- brake parts
- trailer hardware
- locks & pins
- towing & loading
- tie downs
- tools
- chemicals

TRAILER

tires & wheels
axles, hubs & springs
tongue accessories
hitches
electrical
brake parts
trailer hardware
locks & pins
towing & loading
tie downs
tools
chemicals

TRAILER

3/8" DR 5/8" SP SOCKET

- Recessed edges.
- Socket openings are designed to reduce fastener rounding.
- Chrome vanadium alloy steel construction for strength and durability.
- Polished nickel chrome plated finish resists corrosion.
- Large stamping for quick identification.
- Overall socket length: 3-1/4".



260050	6.95	G
--------	------	---

3/8" DR 5/8" SP SOCKET

- Recessed edges.
- Socket openings are designed to reduce fastener rounding.
- Chrome vanadium alloy steel construction for strength and durability.
- Polished nickel chrome plated finish resists corrosion.
- Large stamping for quick identification.
- Overall socket length: 3-5/16".



260051	7.95	G
--------	------	---

3/8" DR SOCKET RAIL

- 18" overall length
- Holds 14 sockets



260042	6.95	G
--------	------	---

5 PC SP SOCKET SET

- Recessed edges.
- Socket openings are designed to reduce fastener rounding.
- Chrome vanadium alloy steel construction for strength and durability.
- Polished nickel chrome plated finish resists corrosion.
- Large stamping for quick identification.
- SAE Sizes: 5/8, 3/4 and 13/16".
- Metric Sizes: 14 and 18mm.



260021	18.95	G
--------	-------	---



10 PC 3/8" DR SAE SOCKET SET

- Packaged on plastic slide rail for storage.
- Recessed edges.
- Socket openings are designed to reduce fastener rounding.
- Chrome vanadium alloy steel construction for strength and durability.
- Polished nickel chrome plated finish resists corrosion.
- Sizes: 1/4, 5/16, 3/8, 7/16, 1/2, 9/16, 5/8, 11/16, 3/4 and 13/16".



260043	15.95	G
--------	-------	---



10 PC 3/8" DR SAE DW SOCKET SET

- Packaged on plastic slide rail for storage.
- Recessed edges.
- Socket openings are designed to reduce fastener rounding.
- Chrome vanadium alloy steel construction for strength and durability.
- Polished nickel chrome plated finish resists corrosion.
- Deep sizes: 3/8, 7/16, 1/2, 9/16, 5/8, 11/16, 3/4, 13/16, 7/8 and 15/16".



260053	27.95	G
--------	-------	---



10 PC 3/8" DR MET SOCKET SET

- Packaged on plastic slide rail for storage.
- Recessed edges.
- Socket openings are designed to reduce fastener rounding.
- Chrome vanadium alloy steel construction for strength and durability.
- Polished nickel chrome plated finish resists corrosion.
- Sizes: 10, 11, 12, 13, 14, 15, 16, 17, 18 and 19mm.



260052	15.95	G
--------	-------	---

10 PC 3/8" DR MET DW SOCKET SET

- Packaged on plastic slide rail for storage.
- Recessed edges.
- Socket openings are designed to reduce fastener rounding.
- Chrome vanadium alloy steel construction for strength and durability.
- Polished nickel chrome plated finish resists corrosion.
- Sizes: 10, 11, 12, 13, 14, 15, 16, 17, 18 and 19mm.



260055	27.95	G
--------	-------	---



19 PC 3/8" DR BLACK SOCKET SET



- 18 double plated black sockets feature both SAE and Metric sockets in popular sizes.
- Easy to read laser etching.
- Ratchet features indestructible protective coating, chrome vanadium steel core with precision 72 gear teeth.
- 6pt SAE Sizes: 5/16, 3/8, 7/16, 1/2, 9/16, 5/8, 11/16, 3/4 and 13/16".
- 6pt MM sizes: 9, 10, 11, 12, 13, 14, 15, 17 and 19mm.



260054 29.95 A

51 PC 3/8" DR MECHANIC'S SET

- Features high torque quick release ratchet.
- 72 gear teeth for 5 degree sweep and smaller head for tight areas.
- 12pt SAE and Metric standard and deep wall sockets.
- Chrome vanadium alloy steel for strength and durability.
- Set contents: 1pc. 3/8" dr. quick release ratchet, 1pc. universal joint, 2pcs. 3 and 6" extensions, 2pcs spark plug sockets, 25pcs SAE and metric std. sockets and 20pcs. SAE and metric deep sockets.
- Durable storage case also included.
- SAE std. Sizes: 1/4, 5/16, 3/8, 7/16, 1/2, 9/16, 5/8, 11/16, 3/4, 13/16, 7/8 and 15/16".
- SAE Deep Sizes: 5/16, 3/8, 7/16, 1/2, 9/16, 5/8, 3/4, 13/16, 7/8 and 15/16".
- SAE Spark Plug sizes: 5/8 and 13/16".
- Metric std. Sizes: 7, 8, 9, 10, 11, 12, 13, 14, 15, 16, 17, 18 and 19mm.
- Metric Deep Sizes: 8, 10, 12, 13, 14, 15, 16, 17, 18 and 19mm.



260057 96.95 G



1/2" DR QR TEARDROP RATCHET

- Quick Release feature for quick and easy socket changes.
- Chrome vanadium alloy steel construction for strength and durability.
- Polished nickel chrome plated finish resists corrosion.
- 72 gear teeth.
- Larger gear teeth for higher torque and added gear strength.
- 9 1/2" Length.



260023 28.95 G

1/2" DR 15" FLEX HANDLE

- Chrome vanadium alloy steel construction for strength and durability.
- Polished nickel chrome plated finish resists corrosion.
- 15" length.

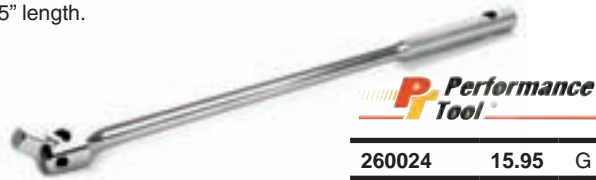

260024 15.95 G

1/2" DR UNIVERSAL JOINT

- Chrome vanadium alloy steel construction for strength and durability
- Polished nickel chrome plated finish resists corrosion



260025 4.95 G

3 PC 1/2" DR EXTENSION SET

- Chrome vanadium alloy steel construction for strength and durability
- Polished nickel chrome plated finish resists corrosion
- Sizes: 3,



260026 13.95 G



3 PC 1/2" DR WOBBLE EXT SET

- Chrome vanadium alloy steel construction for strength and durability
- Polished nickel chrome plated finish resists corrosion
- Increased angle flexibility
- Sizes: 3, 5 and 10"



260027 17.95 G



1/2" F X 3/8" M ADAPTER

- Chrome vanadium alloy steel construction for strength and durability
- Polished nickel chrome plated finish resists corrosion



260028 2.95 G

- tires & wheels
- axles, hubs & springs
- tongue accessories
- hitches
- electrical
- brake parts
- trailer hardware
- locks & pins
- towing & loading
- tie downs
- tools
- chemicals

TRAILER

- tires & wheels
- axles, hubs & springs
- tongue accessories
- hitches
- electrical
- brake parts
- trailer hardware
- locks & pins
- towing & loading
- tie downs
- tools
- chemicals

5 PC SP SOCKET SET 1/2" DRIVE SAE

- Recessed edges.
- Socket openings are designed to reduce fastener rounding.
- Chrome vanadium alloy steel construction for strength and durability.
- Polished nickel chrome plated finish resists corrosion.
- 6pt std. sizes: 1/2, 9/16, 5/8, 11/16, 3/4, 13/16, 7/8, 15/16 and 1".



Performance Tool
260022 19.95 G

9 PC 1/2" DR MET SOCKET SET

- Recessed edges.
- Socket openings are designed to reduce fastener rounding.
- Chrome vanadium alloy steel construction for strength and durability.
- Polished nickel chrome plated finish resists corrosion.
- 6pt std. sizes: 12, 13, 14, 15, 16, 17, 18, 19 and 22mm.



Performance Tool
260029 19.95 G

8 PC 1/2" DR SAE DW SOCKET SET

- Recessed edges.
- Chrome vanadium alloy steel construction for strength and durability.
- Polished nickel chrome plated finish resists corrosion.
- Large stamping for quick identification.
- 6pt deep sizes: 1/2, 9/16, 5/8, 11/16, 3/4, 13/16, 7/8, and 15/16.



Performance Tool
260030 28.95 G

8 PC 1/2" DR MET DW SOCKET SET

- Recessed edges.
- Chrome vanadium alloy steel construction for strength and durability.
- Polished nickel chrome plated finish resists corrosion.
- Large stamping for quick identification.
- 6pt deep sizes: 11, 12, 13, 14, 15, 16, 17, 18, and 19mm.



Performance Tool
260031 28.95 G

10 PC MET HEX BIT SOCKET SET 3/8" DRIVE

- Chrome vanadium steel construction.
- Heat treated for strength.
- Bonus storage rail included.
- Metric sizes: 2, 3, 4, 5, 5.5, 6, 7, 8, 9 & 10mm.



Performance Tool
260016 19.95 G

10 PC SAE HEX BIT SOCKET SET 3/8" DRIVE

- Chrome vanadium steel construction.
- Heat treated for strength.
- Bonus storage rail included.
- SAE sizes: 3/32, 7/64, 1/8, 9/64, 5/32, 3/16, 7/32, 1/4, 5/16 & 3/8".



Performance Tool
260015 19.95 G

12 PC STAR BIT SOCKET SET

- Packaged on plastic slide rail for storage.
- Chrome vanadium alloy steel construction for strength and durability.
- Polished nickel chrom plated finish resists corrosion.
- 1/4" Drive sizes: T10, T15, T20, T25, T27 and T30.
- 3/8" Drive sizes: T40, T45, T47, T50 and T55.
- 1/2" Drive sizes: T60.



Performance Tool
260056 22.95 G

DRIVE HEX BIT SOCKET 5/32" X 3/8"

- Fits on all 3/8" ratchets
- 5/32" hex bit



W38876 3.75 G

22 PC SAE/MET BALL END HEX

- Alloy steel construction.
- Ball end wrenches are perfect for quick and convenient access to screw heads at angles up to 25 degrees.
- Includes plastic holder for storage.
- SAE sizes: 0.05, 1/16, 5/64, 3/32, 7/64, 1/8, 9/64, 5/32, 3/16, 7/32, 1/4, 5/16 and 3/8".
- Sizes: 1.5, 2, 2.5, 3, 4, 5, 6, 8 and 10mm.



260062 12.95 G

30 PC HEX KEY SET

- Long and short shank hex keys.
- Alloy steel construction.
- Includes handy organizer.
- 15 Metric hex keys, sizes: .7, .9, 1.3, 1.5, 2, 2.5, 3, 4, 4.5, 5, 5.5, 6, 7, 8 and 10 mm.
- 15 SAE hex keys, sizes: .028, .035, .050, 1/16, 5/64, 3/32, 7/64, 1/8, 9/64, 5/32, 3/16, 7/32, 1/4, 5/16, and 3/8"



260063 12.95 G

100 PC BIT SET

- Use with screwdrivers, electric drills or socket wrenches.
- Includes bit adapters, magnetic bit holder, "Y" style bits, couplers, Phillips, pozi, square, slotted, spanner, star, torque, tamper resistant star, hex triwing, clutch head and spline bits.



260073 12.95 G

10 PC T-HANDLE HEX KEY SET

- High quality carbon steel shafts
- Black oxide finish resists corrosion
- PVC T-handles for added torque and comfort
- Handy storage rack

SAE sizes: 3/32, 7/64, 1/8, 9/64, 5/32, 3/16, 7/32, 1/4, 5/16, and 3/8 in. Master 10 inner 1.



W80274 17.95 G

METRIC SIZES: 2, 2.5, 3, 4, 4.5, 5, 5.5, 6, 8 & 10 mm. Master 10 inner 1.

W80275 17.40 G



3 PC ALUMINUM HEX & STAR KEY SET

- Lightweight anodized aluminum body and chrome vanadium steel construction for strength and durability.
- Ball end on hex keys allow use at angles up to 25 degrees for obstructed areas.
- Star keys work on regular and tamper proof star fasteners.
- Keys conveniently fold for compact easy storage.
- Coded in high visibility colors for easy identification.
- SAE hex key sizes: 1/16, 5/64, 3/32, 1/8, 9/64, 5/32, 3/16 and 1/4".
- Metric hex key sizes: 1.5, 2, 2.5, 3, 4, 5, 6 and 8mm.
- Star key sizes: T9, T10, T15, T20, T25, T27, T30 and T40.



260064 14.95 G



tires & wheels

axles, hubs & springs

tongue accessories

hitches

electrical

brake parts

trailer hardware

locks & pins

towing & loading

tie downs

tools

chemicals

TRAILER

TOOLS

- tires & wheels
- axles, hubs & springs
- tongue accessories
- hitches
- electrical
- brake parts
- trailer hardware
- locks & pins
- towing & loading
- tie downs
- tools
- chemicals

8 PC HEAVY DUTY HEX KEY SET

- Heat treated alloy steel
- Includes handy key ring style holder to keep keys organized
- Metric sizes: 2, 2.5, 3, 4, 5, 6, 8 and 10mm



W1113 4.55 G

BALL END ALLEN SET

- Made of chrome-vanadium tool steel
- Sizes: 1.5, 2, 2.5, 3, 4, 5, 6, 8 & 10 mm
- Ball end allows for better access to allen-head bolts (up to 25 degree working angle)
- Convenient holder included

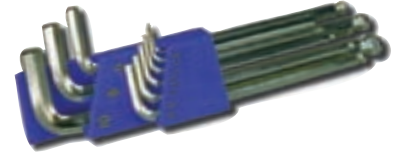

678185 17.99 E

16 OZ BALL PEIN HAMMER

- Drop forged high carbon steel head.
- Heavy duty hardwood handle.



260012 6.95 G



4 LB SLEDGE HAMMER

- Heavy duty fiberglass handles for strength and durability
- Anti-shock, rubber cushion grips
- Mirror polish heads



260009 19.95 G



8 OZ RUBBER MALLET

- Rubber head
- Tubular chrome plated handle
- Rubber grip for comfort
- Many uses around home and shop



260014 2.95 G



16 OZ RUBBER MALLET

- Rubber head
- Tubular chrome plated handle
- Rubber grip for comfort
- Many uses around home and shop



260013 4.95 G



IMPACT DRIVER/BIT SET

- A heavy duty impact driver designed for general shop use
- Reversible, tightens screws or bolts on impact or loosens frozen ones easily
- Complete with 4 bits and metal storage case
- 3/8" square driver



Impact Driver / Bit Set W2500 17.75 G

Repl. 4 Piece Bit Set (Carded) EM03801 2.95 L

3 PC LOCK GRIP PLIERS SET

- Drop forged steel construction.
- Hardened and tempered milled teeth.
- Wire cutters and quick release levers.
- Includes three popular sizes - 5, 7 and 10".



260010 20.95 G

TRAILER

9-1/2" GROOVE JOINT PLIERS

- Drop forged steel.
- Cushion grips.
- Fully polished head.



260011	8.95	G
--------	------	---

4 PC PLIERS SET

- Double cushion grip handles for comfort and control.
- Drop forged steel construction.
- Fully polished and chrome plated.
- Contents: 6" slip joint, 6" diagonal cutting, 6" long nose and 7" linesman pliers.



260019	15.95	G
--------	-------	---

SMALL OIL FILTER PLIERS

- Comfort grip handles
- Safety button locks in place
- Three different positions
- Fits sizes 2-1/4" to 3-1/2" diameter



260109	9.95	G
--------	------	---



LARGE OIL FILTER PLIERS

- Comfort grip handles
- Safety button locks in place
- Three different positions
- Fits sizes 1-7/8" to 4" diameter



260110	11.95	G
--------	-------	---



SWIVEL OIL FILTER WRENCH

- 2 15/16 to 3 3/4"
- Swivel handle design provides access in confined areas
- Vinyl grip handle
- Studded band for better grip
- Removes most spin on type filters



260111	5.95	G
--------	------	---

CUP TYPE OIL FILTER WRENCH

Works with 3/8" drive wrenches



PART #	SIZE
EM04181	5.95 L 64.7 mm
EM04182	5.95 L 67 mm



- tires & wheels
- axles, hubs & springs
- tongue accessories
- hitches
- electrical
- brake parts
- trailer hardware
- locks & pins
- towing & loading
- tie downs
- tools
- chemicals

TRAILER

TOOLS

tires & wheels
axles, hubs & springs
tongue accessories
hitches
electrical
brake parts
trailer hardware
locks & pins
towing & loading
tie downs
tools
chemicals

TRAILER

MINI MULTI TOOL W/MERCH STRIP

- Stainless steel multi tool features spring loaded plier jaws, wire cutters, slotted and Phillips screwdrivers, knife blades, bottle opener, nail file and more
- Handy in your pocket, purse, glove box or tool kit
- Lightweight and durable



260058 10.95 G



3 PIECE DUAL CUSHION ADJUSTABLE WRENCH SET

- 12", 8" and 6" sizes
- 6 point hex openings
- SAE & Metric rules
- SAE box ends in handles 7/16", 1/2" and 5/8"



W30703 35.90 G



6" QUICK RELEASE C-CLAMP

- 6 Tough enamel finish
- Chrome plated screw threads
- Precision crafted for smooth operation
- Features quick-release button to save time and twisting
- Malleable iron construction



260080 16.95 G



CUT & PULL WIRE STRIPPERS

- Cuts and removes insulation from wire with a single squeeze of the handle
- Accepts 18, 14, 12, 10 and 8 gauge wire
- Heavy duty construction with vinyl hand grips



W200 14.30 G



WIRE CRIMPING TOOL

- Wire cutter, bolt cutter, terminal crimper, wire stripper in 1 handy tool
- Black anodized finish with insulated hand grips
- Display packaged



W190 4.50 G



7 WAY CRIMPING TOOL

- Wire cutter, terminal crimper and wire stripper in one handy tool
- Black anodized finish with insulated grips
- Crimp slot on end of tool secures most ignition terminals including "W" type, right angle and "High Tower" terminals
- Crimps 7 mm to 8.5 mm ignition wire
- Works with 10 to 22 gauge solderless terminals



W86500 7.25 G



4 PIECE PLIERS & ADJUSTABLE WRENCH SET

- Double cushion grip handles for comfort and control
- Machined jaws for maximum gripping strength
- Drop forged alloy steel construction
- Cutting pliers feature induction hardened cutting edges for durability
- 6 in. (170 mm) diagonal cutter
- 6 in. (170 mm) long nose pliers
- 7 in. (185 mm) linesman pliers
- 8 in. (210 mm) adjustable wrench



W1701 23.30 G



7 PIECE DUAL CUSHION PLIER SET

- Perfect for a variety of tasks around the home, garage, or workshop
- Pliers feature comfortable grips
- set includes 10 inch groove joint pliers, 7.5 inch diagonal cutter, 8 inch long nose pliers, 4.5 inch mini diagonal cutter, bent nose plier, and end nipper pliers



W30759 35.40 G



15 IN 1 MULTI FUNCTION TOOL

- Compact 6 in. folding design deal for mechanics, campers, sportsmen and more
- Stainless steel blades and tools
- Lightweight aluminum handle with rubber grips for comfort
- Functions: standard pliers, long nose pliers, wire stripper, wire cutter, knife, saw, large slotted screwdriver, medium slotted screwdriver, small slotted screwdriver, Phillips screwdriver, can opener, serrated blade, fine edge, file, bottle opener

W9321 18.95 G



28 PIECE MECHANIC'S SCREWDRIVER SET

- Slotted, Phillips, Offset and Precision Screwdrivers, Star Drivers and Spark Plug Gapper
- Bonus 45°, 90°, Hook and Straight Pick Set



W80028 33.60 G

WITH BONUS SPECIALTY PICK SET



7 PIECE PROFESSIONAL SCREWDRIVER SET

- Extended length handle 3/8 x 8" slotted screwdriver
- 3/16 x 6", 3/16 x 4", 1/4 x 4" and 1/8 x 4" slotted
- #1 x 3", #2 x 4" Phillips
- Variety of sizes included for most jobs
- Display packaged



W80007 12.75 G

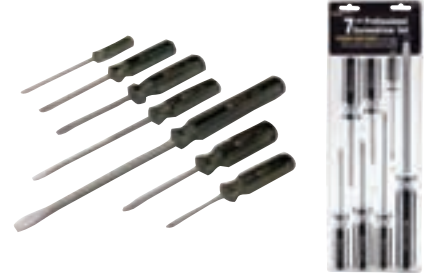

8 PIECE PROFESSIONAL SCREWDRIVER SET

- Oversize handles for easy use
- Magnetic tips
- Contains Phillips #1 X 3", #2 X 1-1/2", #2 X 4", Slotted 3/16" X 3", 1/4" X 1-1/2", 1/4" X 4", Star T-15, T-20 X 4"



W80008 12.25 G



6 PIECE SCREWDRIVER SET

- Popular sizes for a variety of fastening needs
- Oversized comfort grips for more turning power
- Heat treated alloy steel blades for durability
- Plated shafts for corrosion resistance



W1703 13.20 G



7 IN 1 STUBBY BIT DRIVER

- High torque ratchet
- 7 bits stored in handle
- Forward, locked, reverse



W38927 8.90 G



4 IN 1 STUBBY SCREWDRIVER

- Bits store in handle with magnetic hex bit holder
- Includes 3/16" & 1/4" slotted and #1 & #2 Phillips bits
- Each piece individually V.P.C.'d
- Red in color



W964 1.60 G



POCKET SCREWDRIVER COMBO

- Phillips and Slotted screwdriver bits
- Built-in level
- Mini LED light never needs replacing
- Handy pocket clip



W9161 2.95 G

Red, Blue or Yellow
(Our Choice of Color)



Buy 12 and get a free display



- tires & wheels
- axles, hubs & springs
- tongue accessories
- hitches
- electrical
- brake parts
- trailer hardware
- locks & pins
- towing & loading
- tie downs
- tools
- chemicals

TRAILER

TOOLS

tires & wheels
axles, hubs & springs
tongue accessories
hitches
electrical
brake parts
trailer hardware
locks & pins
towing & loading
tie downs
tools
chemicals

TRAILER

8 PIECE DO IT YOURSELF TOOL SET

- Great set for DIY projects/repairs around the home
- Utility knife
- Phillips and slotted screwdrivers
- Phillips and slotted precision screwdrivers
- 8 in. adjustable wrench
- 6 in. linesman pliers
- 10 ft. tape measure



Performance Tool
W1708 17.95 G

6 PIECE HOME TOOL SET

- Versatile set for DIY projects, repairs around the house and general everyday use
- Phillips and slotted screwdrivers
- claw hammer
- slip joint pliers
- Utility knife
- 12 ft. tape measure



Performance Tool
W1707 26.20 G

1/2" DRIVE TORQUE WRENCH

- Reads from 0-150 pounds
- Carded



Performance Tool
W3001 15.95 G

1/2" DRIVE SLICK TORQUE WRENCH

- Chrome plated alloy steel
- * 10 -150 ft. lbs
- * 1 lb. graduations
- * Ratchet style with engraved scale



Performance Tool
W20001 33.60 G

11 PIECE FULL POLISH COMBINATION WRENCH SETS

- Fully polished chrome vanadium steel construction; includes most popular wrench sizes: 1/4, 5/16, 3/8, 7/16, 1/2, 9/16, 5/8, 11/16, 3/4, 13/16, 7/8
- Handy storage rack with easy to carry handle



SAE W1061 19.95 G
Metric W1062 19.95 G



UTILITY KNIFE & BLADES

- 3 position retractable blade
- Extra blade included stores in handle
- Indispensable around the home, shop & office



Knife W745 4.10 L
Blades (5) W744 1.80 L

BREAKAWAY UTILITY KNIFE

- Retractable blade with automatic lock
- End cap detaches to safely break blade tips
- Yellow in color



W972 1.00 G

FOLDING LB UTILITY KNIFE

- Combines the strength of a fixed blade w/convenience of pocket knife
- Change blades with the push of a button
- Compact design folds down to 3 9/16" for easy storage & portability
- Blade locks in open position for safety
- Handy belt clip
- Available in red or blue handle

BLUE HANDLE

260018 6.95 G



RED HANDLE

260017 7.95 G



MINI RAZOR SCRAPER

- Perfect at scraping labels & paint over spray off glass surface
- Tough polypropylene construction
- Protective safety cap
- Ergonomic grip for greater comfort & control
- Includes one standard razor blade



260060 2.95 G

1-1/4" RIGID OFFSET SS SCRAPER

- Perfect for removing gaskets, sealers & caked on materials
- Rigid stainless steel blade w/sharp chisel tip
- Ergonomic grip w/broad hilt for greater comfort & control
- Offset design for hard to reach areas



260072 5.95 G

CARBON & GASKET SCRAPER



- Alloy steel construction
- Zinc plated to resist corrosion



W234 5.35 G

3 PC PRY BAR SET

Curved blade design provides extra leverage • Capped ends allow user to strike with a hammer without damaging the head • Blade protection for added safety • Sizes: 8", 12" and 17 3/4"



260020 12.95 G

2 PIECE SPECIALTY PICK SET



- Hardened tips
- Knurled center grips
- Also useful for retrieving small parts, nuts, washers, etc.
- Contains 90° double end scribe for etching metals and soft materials O-ring & Seal Pick for easily removing & installing O-rings & seals
- Carded



W80750 4.35 G

7 PC CHISEL & PUNCH SET

- Hardened and tempered high carbon steel construction.
- Vinyl covered shank absorbs shock and reduces vibration.
- Handy storage pouch.
- Pin punch sizes: 3/16 x 6".
- Taper punch sizes: 1/8 and 3/16 x 6".
- Center Punch sizes: 3/8".
- Cold Chisel sizes: 3/8, 1/2 and 5/8".



260061 10.95 G

8 PIECE SPECIALTY PICK & DRIVER SET

- Chrome vanadium steel shafts with magnetic tips
- High visibility PVC handles
- Contains: curved hook, offset 45° hook, 90° hook, straight pick, 1/8 in. slotted screwdriver, #0 Phillips screwdriver, T-15 star driver and T-20 star driver

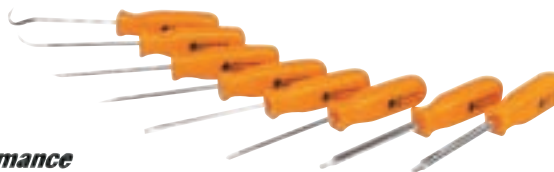

W941 5.95 G

3 PC STEP DRILL SET

- 1/4" hex shank 3 bit set replaces 17 individual drill bits.
- Titanium nitride coated high speed steel.
- For use with metal, wood and plastic.
- Starts on contact, no center punch needed.
- Automatically deburrs holes as you drill.



260091 15.95 G

29 PC DRILL BIT SET W/STEEL CASE

- Durable titanium nitride coated high speed steel.
- Sizes: 1/16" through 1/2" in 64th increments.
- Handy steel storage box included.



260092 36.95 G



tires & wheels
axles, hubs & springs
tongue accessories
hitches
electrical
brake parts
trailer hardware
locks & pins
towing & loading
tie downs
tools
chemicals

TRAILER

tires & wheels
axles, hubs & springs
tongue accessories
hitches
electrical
brake parts
trailer hardware
locks & pins
towing & loading
tie downs

5 PC TAPERED EXTRACTOR SET

- Removes broken studs, screws, bolts, pipes and pipe fittings.
- Chrome vanadium steel.
- Features flutes for more positive grip.
- Includes handy organizer.
- Sizes: 1/8, 3/16, 15/64, 5/16 and 3/8"



260094	4.95	G
--------	------	---

40 PIECE TAP & DIE SETS

- Tap wrench, T-handle tap, wrench, die stock, screwdriver and screw pitch gauge
- NC, NF and NPT sizes
- 17 taps and 17 dies
- Storage case



SAE	W4001	30.40	G
Metric	W4002	30.40	G

4-1/2" ANGLE GRINDER

- 5/8-11 Spindle for Mounting the Most Popular Accessories
- 2-Position Side Handle
- Powerful 5 Amp Motor
- 11,000 RPM No-Load Speed
- Metal Gear Case Dissipates Heat for Longer Life
- Spindle Lock for Quick Wheel/Blade Changes
- Includes: 4-1/2" Grinding Wheel, Side Handle



260087	51.95	G
--------	-------	---

3 IN 1 STAPLER

- Easy slide open staple loading feature.
- Easy smooth squeeze.
- Handy storage case.
- Includes 300 staples, 300 nails and 300 U-Shaped staples.
- Comfort grip handle for extended use.



260076	15.95	G
--------	-------	---



COMBO FINGERNAIL BRUSH W/MAGNET

- Combination fingernail, hand and utility brush
- Contoured handle for better grip



260071	1.95	G
--------	------	---

LED WORKLIGHT

- 24 super bright white LEDs
- Convenient built in hook
- Strong magnet attaches to almost any metal surface
- Swivel hook adjust to multiple angles and stores away easily
- Includes (3) AA batteries



W2424	16.50	G
-------	-------	---



1 M CP SPOTLIGHT - BLACK

- High power quartz halogen bulb.
- Lockable trigger switch for hands free use.
- Comfort grip with built in hanging hook and tripod hole.
- Includes both a car charger and household charger.
- LED charge indicator light.
- Great for roadside emergencies, power failures, camping, boating, home, auto and more.



260078	21.95	G
--------	-------	---



12 VOLT MINI SPOTLIGHT

- 10 watt bulb
- Plugs into 12V receptacle
- Retractable cable (approx. 10 ft.)
- Includes strong magnetic mount



W2376	7.10	G
-------	------	---



SUPER BRIGHT 9 BULB LED POCKET FLASHLIGHT



- 3 1/2" tall
- Knurled barrel for extra grip
- Matt finish camo pattern
- Batteries included

Buy 16 and get a free display



W2452 5.95 G



ALUMINUM LED FLASHLIGHT

- Super Bright Nichia LED never needs replacing
- Anodized aluminum housing
- 55 lumens, 3.5 hour run time, 100m beam

Single LED Flashlight
(Our Choice of Color)



W2451 4.95 G



2 IN 1 LED LIGHT & LASER

- Super bright LED on a flexible obedient head
- Red laser pointer
- Magnetic base and pocket clip keep light positioned where you need it
- Includes 3 LR44 batteries in light, and 3 more packaged with unit

2 in 1 Light & Laser
(Our Choice of Color)



W2380 4.60 G

2-PACK 55 LUMEN LED FLASHLIGHT

- Super bright LED never needs replacing
- Anodized aluminum housing
- 2 count



W2459 10.95 G



POCKET LED FLASHLIGHT

- 3-1/2" Long, 1" Diameter
- LED glows at 55 lumens
- 3-1/2" hour run time with 100m beam
- Push-button On/Off
- Knurled barrel for better grip
- Ideal for tool box, car, or pocket
- Three AAA batteries included



W2450 4.95 G



55 LUMEN TACTICAL LED FLASHLIGHT

- Anodized tactical aluminum housing
- 55 Lumen light output
- 2120 Candela peak beam intensity
- 3.5 hour run time
- 100 meter beam distance
- Dimensions: 4.70 x 1.46 x 1.40 inches
- Weight: 0.2 pounds
- Water resistant
- Ring colors may vary



W2457 8.90 G



5 LED MINI HEAD LAMP

- Adjustable elastic headband
- Adjusts 90° for use anywhere
- Easy on and off, just twist
- Spring loaded slip attaches to hats and other thin items



W2393 6.95 G

NGK LED POCKET FLASHLIGHT

- 9 ultra-bright white LED's
- all lights continue to function even if one burns out
- AAA batteries included, not inserted
- 100,000 hours LED life cycle rating



228113 10.00 B

tires & wheels
axles, hubs & springs
tongue accessories
hitches
electrical
brake parts
trailer hardware
locks & pins
towing & loading
tie downs
tools
chemicals

TRAILER

TOOLS

tires & wheels
axles, hubs & springs
tongue accessories
hitches
electrical
brake parts
trailer hardware
locks & pins
towing & loading
tie downs
tools
chemicals

100 PC 8" WHITE CABLE TIES

260082 4.80 G

- 100 Pc Cable Ties
- 8" Length
- Tensile Strength 40 Lbs
- Resealable Bag



100 PC 8" BLACK CABLE TIES

260083 3.95 G



50 PC 11" CABLE TIES

- 1/8" wide x 11" long.
- 25 white and 25 black.
- UL approved nylon.



260081 2.95 G



MULTI-PURPOSE CABLE TIES

HANDY ASSORTMENTS FOR THE HOME, OFFICE, OR SHOP

1000 Piece Package: includes:

QTY	COLOR	LENGTH
100	Yellow, Blue, Red, Green and White	4"
100	White	6"
100	Yellow, Red, White	8"
100	White	12"



W2925 17.30 G

MULTI-PURPOSE CABLE TIES

HANDY ASSORTMENTS FOR THE HOME, OFFICE, OR SHOP

250 Piece Package



W2918 7.80 G

25' X 1" SAE/MET TAPE MEASURE

- Convenient and quick fractional readout every 1/8".
- Both SAE and Metric markings on tape measure blade.
- Durable casing stands up to rough treatment.
- Easy to find bright color.



260059 5.95 G

DIGITAL CALIPER

- Measures outside, inside depth and step 0-6"
- Large, easy to read led LED display
- Zero setting at any position within measuring range
- On/off switch
- Battery included
- Thumb wheel with lock
- Display packaged



W80152 25.95 G

6" PLASTIC CALIPER

- 4 way measurements for outside, inside, step and depth.

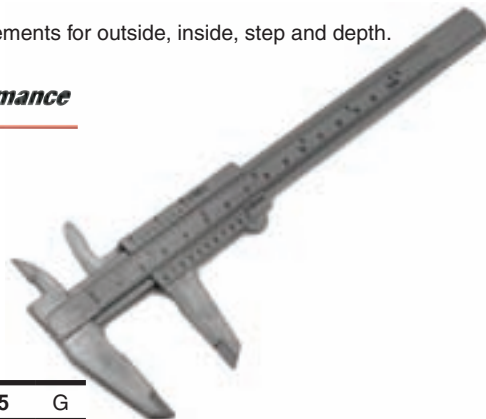

260093 1.95 G

6" COMPOSITE DIGITAL CALIPER

- Rugged impact resistant composite material
- Easy to read SAE and metric LCD display
- Low battery warning with 12 month average battery life
- Includes 1.5V button cell battery
- Specifications: accuracy +/- .001" (.2 mm)
- Resolution: 0.0005"/0.01 mm
- Throat depth: 1 9/16"
- Temperature operating range: 32 deg. F to 104 deg. F
- Overall length: 9 1/2"

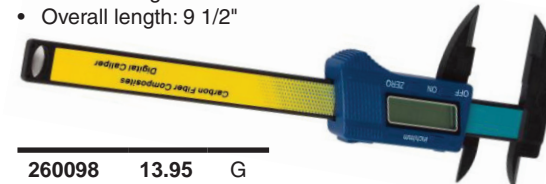

260098 13.95 G

TRAILER

SAE & METRIC SIZE CATCHER

- Instantly measure the size of any nut or bolt head
- Inch and metric gradations on opposite sides
- SAE range of 5/16 to 1 in. Metric range of 8 to 25 mm
- Easily carried in pocket or on key chain
- Display packaged



W9162 7.05 G

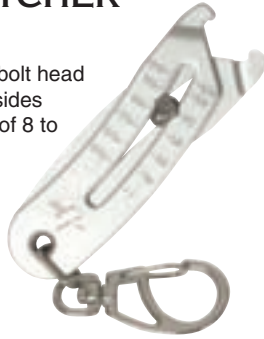

SPARK PLUG GAP GAUGE

- Display packaged
- .020, .025, .028, .030, .032, .035, .040



W162 2.30 G



SPARK PLUG GAPPER

- Easy to read markings
- Set gaps quickly & easily
- Range: .020" to .100" (.5 to 2.5mm)
- Tapered hole adjusts electrode
- Display packaged



W80535 1.20 G



SPARK PLUG THICKNESS GAUGE

- 32 blades
- Decimal & metric sizes
- .010" brass blade for transistorized ignitions



W125 6.60 G



SPARK PLUG GAUGE

- 8 spark plug gauges
- Decimal & metric sizes
- Electrode adjuster .015, .018, .020, .025, .028, .030, .035, .040, 0.40m, 0.45m, .50m, .064m, 0.70m, 0.75m, 0.90m, 1.00m
- Display packaged



W127 4.55 G

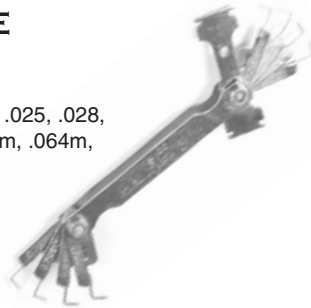

SPARK PLUG THICKNESS GAUGE

- 15 blades
- Decimal & metric sizes
- 3" steel rule



W131 4.30 G



TAPPET FEELER GAUGES

- Accurate tappet adjustments
- Angled blade for easy access to tappets
- Makes adjustment quick and easy

.002-.003	678052	27.99	E
.004-.005	678053	29.99	E
.006-.008	678054	29.99	E



7 PC BEARING RACE & SEAL DR SET

- Quickly and easily installs wheel bearing races and seals without destruction to race or axle housing.
- Set includes six discs to fit common bearing sizes.
- Sizes: 1.565, 1.75, 1.965, 2.325, 2.47 & 2.555".



260095 36.95 G



120 PC MINI FUSE ASSORTMENT

- 120 Pc. Mini Blade Fuse Assortment.
- Contains 20 pieces each of: 5, 10, 15, 20, 25 and 30 Amp fuses
- Convenient storage case

260088 12.95 G

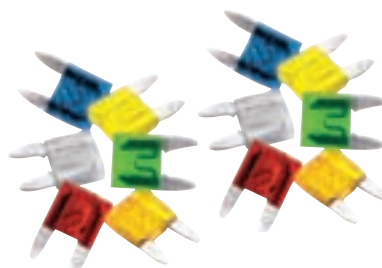

- tires & wheels
- axles, hubs & springs
- tongue accessories
- hitches
- electrical
- brake parts
- trailer hardware
- locks & pins
- towing & loading
- tie downs
- tools
- chemicals

TRAILER

tires & wheels
 axles, hubs & springs
 tongue accessories
 hitches
 electrical
 brake parts
 trailer hardware
 locks & pins
 towing & loading
 tie downs
tools
 chemicals



SAFE WORK ENVIRONMENTS ARE EXPECTED TODAY! THAT DOES NOT HAVE TO MEAN THAT SAFETY PRODUCTS CANNOT BE BOTH DESIRABLE AND STYLISH. IN FACT SOME SAFETY PRODUCTS HAVE CLEARLY CROSSED THE LINE BETWEEN "HAVE TO WEAR" AND "WANT TO WEAR".

RANGER POLYCARBONATE FRAME/LENS

- Functional safety glasses never go out of style
- Complete protection at a very economical price
- The design incorporates side shields and brow protection
- Lens made from uncoated Polycarbonate, and it provides excellent impact resistance, as well as 99.9% UV protection
- Amber lens improves contrast at dusk or in overcast conditions
- Fits over many prescription glasses
- Ranger complies with ANSI Z87.1-2003 (Z87+) and CE-EN-166



Clear	EV10C	2.45	B
Amber	EV10A	2.65	B

MAXIMUFF HIGH PERFORMANCE, ECONOMY EAR MUFF

- Super Seal ear cushions for long term comfort
- A soft cushioned headband
- Self-aligning suspension, and easy adjustment
- 28 dB NRR, 30 dB SNR



EV35	15.95	B
-------------	--------------	---



VALUEMUFF COMFORT AND PROTECTION

- Soft and pliable Super Seal ear cushions
- Low headband force and light- weight, 6.8 oz.
- Easy adjustments with flexible slide clips
- Noise Reduction Rating down to 25 dB NRR - 28 dB SNR

EV25	10.30	B
-------------	--------------	---

BLUE CORDED EAR PLUGS

- Cushioning foam, tapered pod design for easy insertion into any size ear canal
- Assures uncompromising seal
- Noise reduction rating of 32 db (decibels)



SAVE 10% WHEN YOU BUY 100!

EV211	0.40	B
--------------	-------------	---

PROGUARD YELLOW SAFETY CAPS

Elvex ProGuard safety caps offer the following features and benefits:

- The lightweight shell is made from tough Polyethylene
- ProGuard is available with pin-lock and two different ratchet suspensions
- The standard suspensions are made from flexible Polypropylene and have wide contact areas towards the head. This helps provide long term comfort and durability. A soft brow pad is standard.



EV304	7.50	B
--------------	-------------	---

SAFETY GOGGLES



- Impact resistant plastic lens
- Adjustable strap
- One size fits all

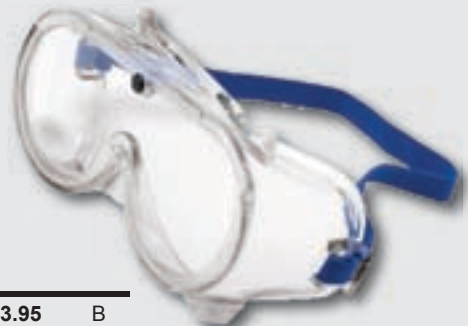

W1024	3.95	B
--------------	-------------	---



GO-SPECS™ LIGHTWEIGHT LIKE SAFETY GLASSES, SEALING LIKE GOGGLES

Elvex Go-Specs™ primary objective is to provide an extra measure of protection in dusty and dirty environments. Wind blown particles such as dust, sand, cement, chemicals can cause serious eye irritation and damage. In addition to this specialized task, Go-Specs offers a full range of features and benefits:

- Impact resistant molded lens with SuperCoat™ anti-fog coating
- 1.8 mm thick Polycarbonate lens with a base 6 curvature
- Polyurethane foam seal
- Angle adjustable temples
- 99% UV protection for UV A, B and C, 180-380 nm
- Tested to ANSI Z87 (+)
- High velocity impact resistant

Clear Anti-Fog	EV401	10.20	B
Gray Anti-Fog	EV402	10.55	B

XENON ULTRA LIGHTWEIGHT DESIGN FOR COMFORT & STYLE

- Elvex Xenon safety glasses represent our most lightweight design. They are so lightweight that it is easy to forget that you have them on.
- Xenon fits smaller faces and female faces very well.
- Comfortable and stylish design
- In addition to its good looks Xenon offers a soft rubber nose bridge and colorful rubber inserts on the temples.
- Tested to ANSI Z87.1-2003 (Z87+), and to CE EN-166.

Clear	EV141	2.75	B
Clear Anti-Fog	EV142	3.65	B
Blue	EV143	2.95	B
Indoor/Outdoor	EV144	3.40	B
Gray	EV145	2.95	B
Gray Anti-Fog	EV146	3.85	B
Mirror	EV147	3.40	B



ORBIT COOLEST STYLE YET

- Cool wrap design with straight temples
- Straight rubber tipped temples
- Tinted lens version have a shiny silver frame
- Complies with ANSI Z87+

Clear w/Graphite Frame	EV361	5.75	B
------------------------	--------------	-------------	---

ELITE FOR THE STYLE CONSCIOUS

Styling aside, this frame offers a soft rubber nose bridge as well as rubber tipped temples. Complies to ANSI Z87.1-2003 (Z87+).

Clear w/Gray Frame	EV2001	5.25	B
Clear w/Blue Frame	EV2002	5.25	B
Gray Lens w/Black & Yellow Frame	EV2003	5.50	B
Indoor/Outdoor w/Gray Frame	EV2004	5.95	B



TRIX HIGH STYLE COMBINED WITH LOW COST

Trix safety glasses provide style and comfort at a very affordable price.

- Available in the following lenses: clear, clear anti-fog, gray, indoor/outdoor and silver mirror
- All lenses provide 99% UV protection
- Universal length temples
- Complies with ANSI Z87.1-2003 (Z87+) and CE-EN-166

Clear	EV171	3.10	B
Clear Anti-Fog	EV172	3.95	B
NCB Gray	EV173	3.30	B
Indoor/Outdoor	EV174	3.95	B

UNIWRAPS THE MOST POPULAR

UniWraps was one of the first wrap style safety glasses to integrate lens and side shield in a seamless design. This model has been re-engineered with a new frame and new temples that adjust in angle and length.

- Improved nose bridge makes these glasses very comfortable to wear
- Lenses available to protect against most harmful lighting conditions
- Complies with ANSI Z87.1-2003 (Z87+) and CE-EN-166

Clear	EV201	6.80	B
-------	--------------	-------------	---



- tires & wheels
- axles, hubs & springs
- tongue accessories
- hitches
- electrical
- brake parts
- trailer hardware
- locks & pins
- towing & loading
- tie downs
- tools
- chemicals

TRAILER

TOOLS

- tires & wheels
- axles, hubs & springs
- tongue accessories
- hitches
- electrical
- brake parts
- trailer hardware
- locks & pins
- towing & loading
- tie downs
- tools
- chemicals

2" FINE CUPPED WIRE BRUSH

- 1/4" Shank
- Use with any power drill to remove paint, rust, dirt, etc.
- Useful for cleaning steel parts, surface preparation, deburring and edge blending

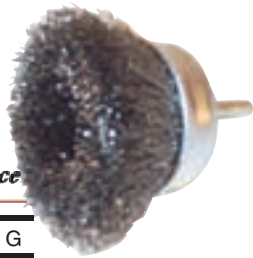

Performance Tool
W1212 4.60 G

UTILITY WIRE BRUSH

- Solid wood handle
- Steel bristles
- Carded



Performance Tool
W1152 2.80 G

T-HANDLE SOCKETS

- T-handle socket made of chrome vanadium tool steel
- Deep 6 point sockets with a carbon steel T-style handle
- Nickel pewter finish
- Hex socket extends only part way inside
- Lifetime warranty
- Thin wall



8mm	678093	5.99 E
10mm	678094	6.50 E
12mm	678095	6.99 E
13mm	678096	6.99 E
14mm	678097	6.99 E
17mm	678098	10.99 E
19mm	678099	10.99 E

T-HANDLE RACK

- Chrome finish
- 11 slots
- Hooks on your tool box



680144 17.99 E



WALL BRACKET FOR T-HANDLE RACK

- Wall bracket for T-handle rack above to mount on a wall, post, or any flat surface
- Features a quick release pin
- Heavy duty 12 gauge zinc plated steel
- Includes built in bottle opener



680435 21.50 E



T-HANDLE DRIVES

- Use any 1/4 in drive attachments such as sockets hex drives crows foot or swivels
- Chrome vanadium tool steel shafts
- Durable nickel pewter finish
- Allows optional ways to use any 1/4 inches drive attachments such as sockets, hex drives, crows foot or swivels



1/4" drive, 8-1/2" long	678158	7.99 E
3/8" drive, 10-1/2" long	678159	8.99 E

SWIVEL SEAT BAR STOOL

- 30" high with 14" round seat
- Durable vinyl padded seat swivels 360°
- Sturdy chrome plated legs
- Non-slip rubber feet for stability

Great for your garage, game room, etc.



Performance Tool
W85010 54.90 G

ROLL - AROUND STOOL

- Pneumatic action adjusts seat to 20" height quickly & easily
- Convenient 15" diameter tool tray
- Shielded 2-1/2" casters
- Fully padded 12" diameter seat



Performance Tool
W85008 51.60 G

10 PC T-HANDLE STAR KEY SET

- PVC T-handle grips for added torque & comfort
- High quality carbon steel shafts
- Black oxide finish resists corrosion
- Handy storage rack
- Sizes: T7, T8, T9, T10, T15, T20, T25, T27, T30, T40



Performance Tool
W80276 17.40 G

METRIC MULTI-PURPOSE TOOL

- A must-have for on-the-trail repairs or adjustments
- Can be used to remove 8 mm, 10 mm, 12 mm & 14 mm bolts, No. 2 & No. 3 Phillips screws, small & medium straight-slot screws and 5 mm & 6 mm hex bolts
- Includes a 1/4 in. & 3/8 in. socket driver
- 10 mm & 12 mm 1/4 in. drive sockets included
- Enhance it by adding your own 1/4 in. or 3/8 in. drive socket attachments
- Includes convenient carrying case
- Hard nickel pewter finish
- Perfect for any tool pack



678030 58.99 E

TRAILER

QUICK TIES

- Simple, secure, and strong
- Floats
- No knots, no stretching, no hooks to slip
- High density steel alloy core with high density foam coat
- Retail packaged
- 4 pack

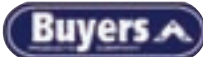

BY5480 5.65 G

61 PIECE HAND RIVETER SET

- Includes riveter with 4 nozzles
- 15 each of the following rivets: 3/32, 1/8, 5/32 and 3/16 in.



W2017 15.20 G

PISTON RING COMPRESSOR

- Use to install pistons on most passenger cars.
- Positive compression and adjustable friction brake.
- Instructions included.
- Band Diameter Sizes: SAE 2 1/8 to 5" (Metric 53 to 127mm)



260096 15.95 G

PISTON PIN PULLER

Remove or install piston wrist pins easily with this puller from SLP. The body of this puller is made of a special high strength composite which eliminates marking, scarring or distortion of the piston. The face of the body of this puller is specially designed to bridge recessed wrist pin bosses found on late model pistons in order to provide a straight, precise pull each and every time. It is provided with three different sizes of nuts, which fit wrist pins from 15mm thru 24mm.



SP20181 59.95 B

PISTON RING INSTALLER

- Installs and removes piston rings 3/64" (1.2-6.35mm)
- Comfortable vinyl grip handles



W80575 6.95 G

NITRILE GLOVES

- 100% synthetic nitrile polymer
- Superior puncture, tear and chemical resistance with excellent dexterity
- Latex free and powder free, eliminates potential allergic reactions to natural rubber latex protein
- Textured surface provides strong grip for both wet and dry applications
- Protects hands from oil and grease
- Great for dirty/grimy jobs
- Universal fit for right or left hand



M	144295	13.99	E
LG	142516	13.99	E
XL	142517	13.99	E

SNAP RING PLIERS

- Economical pliers that easily does both inside and outside opening snap rings or clips
- Includes 3 extra sets of tips, 1 additional straight tip and 2 offset or angled tips



678186 15.99 E

COMBINATION INTERNAL/EXTERNAL SNAP RING PLIERS

- Compress internal rings with one pair and expand external rings with the other
- Complete with 2 pliers and 4 sets of tips

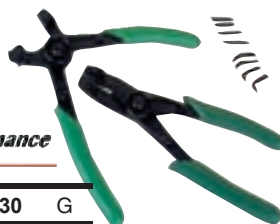

1725 11.30 G

CLAW & MAGNETIC RETRIEVERS

- Pick up bolts, screws, washers, etc. from confined areas
- Indispensable for home & workshop
- Flexible shaft reaches confined areas
- Strong durable magnets and powerful claws for easy retrieval
- Carded



24" Retriever Claw W1184 2.95 G

24" Magnetic Retriever W1182 3.10 G

8 LB. MAGNETIC PICKUP TOOL

- Heavy duty magnetic tip retrieves objects up to 8 lbs.
- Retriever extends over 24"
- Cushion grip handle
- Handy pocket clip
- Sold each



W9101 3.50 G

POCKET MAGNETIC RETRIEVER

- Extends from 4 3/4" to 18 1/2"
- Convenient pocket clip
- Easily retrieves small parts from confined areas



W1261 2.55 G

- tires & wheels
- axles, hubs & springs
- tongue accessories
- hitches
- electrical
- brake parts
- trailer hardware
- locks & pins
- towing & loading
- tie downs
- tools
- chemicals

TRAILER

TOOLS

- tires & wheels
- axles, hubs & springs
- tongue accessories
- hitches
- electrical
- brake parts
- trailer hardware
- locks & pins
- towing & loading
- tie downs
- tools
- chemicals

3 PIECE INSPECTION TOOL SET

- Lighted magnetic pickup tool
- Telescoping inspection mirror
- Mini magnetic parts tray



W1932 14.40 G

SWIVEL INSPECTION MIRROR

- 2" round mirror with multi-direction swivel for visual access to confined areas
- Chrome plated corrosion resistant shaft extends from 11-1/2" to 18"
- Vinyl grip



W1262 5.30 G

MAGNETIC TRAYS

- High quality heavy duty magnet
- Sticks to almost any metal surface
- Keeps small metal parts and tools from getting lost or misplaced
- Very handy even sideways or upside-down



Round W1264 5.20 G
Oblong W1265 11.10 G

SMALL ENGINE CYLINDER HONE

- Fits 1-1/2" to 4" cylinders
- 1/4" flex drive
- Easy adjustments to any small engine application
- Length: 8-1/2"
- Complete with stone - plated



Cylinder Hone W80560 36.95 G
Set of 3 Repl. Stones W80561 12.45 G

PERFORMANCE TECH WEAR MECHANIC GLOVES

- Protects hands from cuts, scrapes and burns
- Comfortable and durable
- Thick enough to protect and thin enough to handle small objects
- Soft, flexible fabric is breathable and easy to clean



Small W88998 20.95 G
Medium W88999 20.95 G
Large W89000 20.95 G
X-Large W89001 20.95 G

DIGITAL MULTI TESTER

- For use on household appliances, automotive (computer controlled and standard ignitions)
- A variety of hobbies
- Features AC and DC volt measurement, DC current measurement, resistance measurement, diode test and ohms
- Complete with 2 test leads
- UL approved
- Detailed instruction booklet included
- Includes 9 volt battery

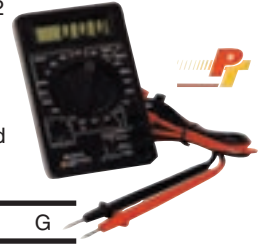

W2974 14.40 G

BATTERY/ALTERNATOR VOLTAGE CHECKER

- For all 12 volt systems
- Easy to read LED lights
- Shows battery state-of-charge and level of alternator output



W2980 9.95 G

POCKET MULTI-TESTER

- Analyzing functions for Volts AC, Volts DC, amperes and ohms
- Operates on 1 AA battery (included)
- Instructions included



W2979 12.00 G

TUBE STYLE BATTERY TESTER

- Easy to read color coded hydrometer
- Gives precise readings for status of battery cells
- Acid resistant



W1653 4.15 G

BATTERY TERMINAL CLEANER

- All metal construction
- Quality stainless steel brushes
- Cleans both battery post and terminals



W147 2.60 G

DELUXE 12 VOLT TESTER

- Checks 12V accessory circuits
- For autos, trucks, trailers and boats
- Test lead with alligator clip



W2975C 3.15 G

12 VOLT HEAVY DUTY CIRCUIT TESTER

- Heavy duty 5 foot test lead with spring clip
- Tests 6, 12 & 24 volt AC and DC circuits
- Reinforcing spring prevents damage to test lead at base of handle



W2981 6.75 G

TRAILER

ECONOMY IGNITION TESTER

An easy to use, time saving piece of shop equipment



1754 11.20 G

DUAL IGNITION SYSTEM TESTER

- Test the integrity and strength of your ignition system
- Spark plug gap is adjustable from 0 to 10 mm
- The larger the gap our ignition will jump, the stronger your system is
- Will test the ignition on most motorcycles, watercraft, ATVs and snowmobiles



678122 10.50 E

DEGREE WHEEL

- Manufactured from .052 in. thick aluminum with a 6 3/4 in. outside diameter and a 6 mm center hole
- Black anodized finish with easy to read numbers
- Check or set ignition and/or cam timing
- May be used on 2 & 4-stroke engines



678092 14.99 E

SPRING HOOK

Exhaust spring tool with rubber coated handle



6212206 14.95 L

DELUXE SPRING TOOL



214091 17.95 G

SPARK PLUG WIRE TESTER

- Identifies damaged spark plug wire easily by moving tool along wire towards spark plug
- Tester light flashes in sync with spark plug firing
- When light stops flashing, break in wire has been located
- Display packaged



W80530 8.30 G



IGNITION/SPARK PLUG TESTER

- Checks the integrity of the electrical ignition and magneto/coil ignition systems of lawn mowers, boat motors, motorcycles and automobiles
- Checks both current and voltage and will indicate fouled odes
- E-Z view LED and neon lamps for easy accurate reading, pocket size



7731 9.95 H

MINI SPRING HOOK TOOL

- Ergonomic handle provides a secure grip at every angle
- For use on exhaust pipe springs, seat or tank holding springs, cotter pins, side stand springs and more



144166 6.99 E



HEAVY DUTY SPRING HOOK

- To compliment the current light duty spring hook tool, our heavy duty version developed specifically to handle those large diameter side-stand springs found on many street bikes
- The T-handle adds security to your grip when applying tension to the spring



678127 15.99 E



DELUXE SPRING TOOL MULTI-PAK



214092 39.95 G

- tires & wheels
- axles, hubs & springs
- tongue accessories
- hitches
- electrical
- brake parts
- trailer hardware
- locks & pins
- towing & loading
- tie downs
- tools
- chemicals

TRAILER

- tires & wheels
- axles, hubs & springs
- tongue accessories
- hitches
- electrical
- brake parts
- trailer hardware
- locks & pins
- towing & loading
- tie downs
- tools
- chemicals

SUPER-DUTY BOOSTER CABLES

- 55% more power than 10 gauge cables
- Patent pending Cinch-Lock™ Technology for safer and easier jump starts



232025 35.95 G



BATTERY JUMPER CABLES

- Conveniently sized for motorcycle-to-motorcycle jump start
- Five feet in length
- Heavy-duty alligator clips are color-coded red and black
- Conductor wire is firmly soldered to clamp for durability and reliability



142500 15.99 E

BATTERY JUMPER CABLE SET

- 64" long
- 10 gauge
- Color coded terminal
- Clamps for safe and secure handling
- Display packaged



EM96300 12.95 L

JUMPER CABLES

- Easy to use, easy to store
- Convenient storage bag
- Heavy duty, 8 ft., 8-gauge cables won't stiffen or freeze
- Tangle resistant, encased rubber grips for safer use



920-228 25.95 E

EMERGENCY TOW ROPE 1" X 15'

- 2" x 15 FT
- 8,500 lb. maximum load capacity
- Polyester webbing
- Heavy duty zinc plated hooks



W1420 21.30 G

EMERGENCY TOW ROPE 2" X 20'

- 2" x 20' emergency tow strap, Poly webbing
- 10,000 lb. break strength capacity
- (3,300 safe working load)
- Heavy duty zinc plated hooks
- Intended for vehicle recovery
- **Not intended for prolonged towing**



W1422 25.40 G

PVC ELECTRICAL TAPE

- Black
- Heavy gauge 7 mil. thermo-plastic UL approved for insulation of splices in insulated conductors of 5000 volt rating

3/4" x 30'	W501	0.75	L
3/4" x 60'	W502	1.20	L



DUCT TAPE

- 1-7/8" x 30'
- Sold each

Performance Tool			
W3103	2.40	G	



SPARK PLUG WRENCH

- 12mm wrench - Fits all "D" size NGK spark plugs
- Zinc Plated
- 4-5/8" in length



EM04110	4.95	L
---------	------	---



HEAVY DUTY SPARK PLUG WRENCH

- 10mm - 14mm
- 3 way tip to fit all ATV spark plugs
- Chrome finish
- 2-7/8" in length

EM04100	4.95	L
---------	------	---

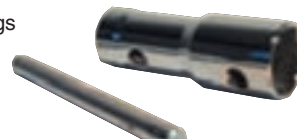

SPARK PLUG HOLE THREAD CHASER

- Quickly & easily cleans dust, carbon & metal particles from spark plug hole
- 18mm turn with 13/16" deep socket
- Display packaged



W80539	7.25	G
--------	------	---



RATCHET SPARK PLUG WRENCH

- Designed to fit where there is limited space on many water-cooled 2-stroke machines
- Ratchet mechanism works one way
- Fits standard 13/16" plugs

678147	15.99	E
--------	-------	---



3/8" DR SOCKETS 14MM/18MM

- Heat treated alloy steel
- Drop forged for strength
- Polished
- Display Packaged

14mm	W886	3.90	G
18mm	W890	4.85	G



SPARK PLUG WRENCH

- Cast, chrome finished
- Combination wrench fits 14mm or 18mm spark plugs

LP15849	5.95	L
---------	------	---

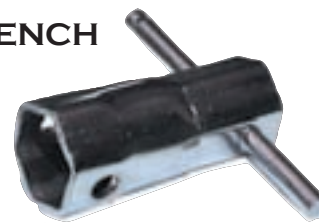

HEAVY DUTY NUT SPLITTER

- Removes rusted, stripped, and stubborn nuts
- Self-centering wobble tip
- Offset design for easier operation
- Splits nuts 7/16" to 3/4"
- Drop forged steel construction
- Plated to resist corrosion
- Heat treated chisel

W88030	16.75	G
--------	-------	---



HEAVY DUTY 3 JAW GEAR PULLERS

- Heavy duty drop forged steel
- Heat treated for maximum strength
- Jaws plated for corrosion resistance
- Reversible jaws for multiple applications

4"	9020	14.95	B
6"	9021	20.95	B
8"	9022	30.95	B



UNIVERSAL FLY WHEEL PULLER

- One-piece machined design for extra strength
- Puller includes:
 - (6) 6mm bolts
 - (4) 8mm bolts with washers



725-010	44.95	G
---------	-------	---



FLYWHEEL PULLER

- For most ATVs, snowmobiles, motorcycles and watercraft engines
- Complete with hardware kit and adapter for male or female removal

629620	41.95	L
--------	-------	---



tires & wheels
axles, hubs & springs
tongue accessories
hitches
electrical
brake parts
trailer hardware
locks & pins
towing & loading
tie downs
tools
chemicals

TRAILER

12V AUXILIARY POWER SOURCES

The following items provide a dependable source of power for electrical accessories using a standard adapter plug. For spotlights, tire pumps, GPS, cell phones etc. Can be installed on any 12V system such as snowmobiles, ATVs, tractors, boats, vehicles, motor homes etc.

CIGARETTE LIGHTER WITH MAP LIGHT

30" extension with combination lighter/map light. Easy... Handy... Plugs into lighter socket. Comes with hang clip.



EM44420 14.95 L



POWER OUTLET

12 Volt power outlet. Requires 12 volt battery source. Fits all Ski-Doo models plus many others. Replaces Ski-Doo #861-5072-00



571085 13.95 L

CIGARETTE LIGHTER

Moisture-resistant lighter designed for all weather use in an open space. Clamp-on design fits almost anywhere.



EM44410 16.95 L



UNIVERSAL DC CONNECTOR

With dash adapter. Will fit your electric shields, handlebar grip heater, hot socks, phone bags, etc. Rca standard.



621601 6.95 L

EXTENSION POWER CORD

With On/Off switch. Can take up to 12 amp and 150 watts of current.



621201 9.95 L

9 FOOT POWER OUTLET

Clips to any 12 volt battery. Perfect item to plug in spotlights, cell phones, etc. 3 foot cord and 15 amp safety fuse. Plastic.



621203 6.95 L

DUAL POWER OUTLET

The perfect solution when you want to plug in several items at one time.



621202 9.95 L

12-VOLT 3-WAY OUTLET

- 12-volt DC accessory plug
- Built-in 10 amp fuse protects against overload
- Useful for multiple 12-volt accessories: cell phone charger, GPS, laptop, strobe light
- Retail packaged

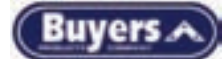

BY5601 6.45 G

POWERPOINT 12 VOLT POWER OUTLET W/RELAY

- Wire length 150cm
- Mounts to your handlebars or can be installed without handlebar clamp
- 100% waterproof
- Includes everything needed to install



120140 48.95 L

CIGARETTE LIGHTER POWER PORT

Equipped with an LED power-alert & USB output jack



120141 13.95 L

RCA JACK DUAL SPLITTER

- Converts any single-output RCA power source into two power ports
- Works great when you need to operate communication systems, heated helmet shields and other electrical accessories



120142 5.95 L

CIGARETTE LIGHTER POWER PORT

Equipped with an LED power-alert, RCA output jack



Replaceable 10 Amp Fuse	120120	9.95	L
Non-replaceable Fuse	621200	7.95	L

EMERGENCY CELL PHONE CHARGER

- Features 2 bright white LEDs
- Provides limited battery charge for emergency situations
- Charger specifications: Input voltage is 1.2 to 1.5 volts. Output voltage is 5.7v +/- 5%
- Charging time is 1 to 3 hours (varies by phone, battery levels and capacity)
- Typical efficiency is 88 to 93%
- Includes 7 adaptors for Nokia, Samsung, Sony Ericsson, Apple, Blackberry and Motorola brand cell phones



260077 10.60 G

CARBURETOR LEAK DETECTOR

Provides a simple method of checking needle and seat pressure as well as impulse diaphragms, etc.

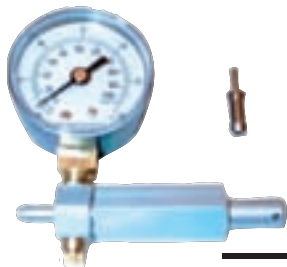

LD1075 56.95 G

CARBURETOR VACUUM SYNCHRONIZER FOR BALANCING MULTIPLE CARBURETORS

This precision instrument gives mechanics and technicians a visual method of balancing carburetors with a high degree of accuracy, assuring the ultimate in performance from an engine

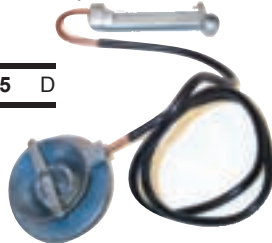

ED4027 53.95 D

POP OFF GAUGE

Used to calibrate pop off pressure - calibrates 1/2 psi increments up to 30 psi



MKBN 68.95 B

CARBURETOR POCKET TUNER

This pocket size calculator can be used to determine required jetting changes in carburetors due to changes in temperature and altitude.



MK550 7.20 G

CARB ADJUSTING TOOL

Designed for multi-units. Fits both Mikuni and Keihin carburetors. 11" long, made of alloy steel.



678022 18.99 E

MIKUNI CARB TOOL KIT

Service tool kit includes all tools necessary to service Mikuni carburetors.



Genuine Mikuni **VMTK 29.65 D**
Imported **LP15866 14.95 L**

COMPRESSION TESTER 0-300 PSI

- Tapered rubber tip fits all common spark plug holes.
- Large easy to read gauge.
- SAE (0 PSI to 300 PSI) and Metric (1 to 21 kg/cm2)



260097 19.95 G

FCR CARB TOOL

- Contains longer bits for reaching into recessed cavities to adjust Keihin FCR carburetors
- Ideal for trail riders and garage mechanics alike
- Includes 6mm hex for main jets, long-reach straight slot for pilot jets & a 3mm Allen for float bowl removal.



678181 16.50 E

MAIN JET WRENCH & CARRIER

- Rubber cap holds spare main jets in handle
- Aftermarket



6mm hex **678023 5.50 E**

MIKUNI SPARE JET CARRIER

Now you can store 19 spare main jets in a molded neoprene rubber carrier complete with special jet removal tool. Carrier may be placed in tool box without loss or damage to precision jets.



LP07301 7.95 L

90 DEGREE 1/4 INCH HEX DRIVER

- Precision made of aircraft grade aluminum and stainless steel
- Designed for hard-to-reach areas and air/fuel mixture screws on multi-cylinder motorcycles
- Gear driven 1/4 in. hex drive
- Includes five 1/4 in. hex drive bits (all 1/2 in. long) - Straight-slot, Phillips, D-shaped air/fuel mixture screw bit, 6 mm hex jet bit & 1/4 in.-hex-to-1/4 in.-drive bit
- Can be used with any 1/4 in. or 6mm hex bits
- Strongest tool of its type on the market
- Max torque is 60 in. lbs.
- 17.5 in. long
- Replaceable drive gears
- Limited 1-year warranty
- Replaces OEM Harley-Davidson® #HD-33413-A



142164 76.99 E

- tires & wheels
- axles, hubs & springs
- tongue accessories
- hitches
- electrical
- brake parts
- trailer hardware
- locks & pins
- towing & loading
- tie downs
- tools
- chemicals

TRAILER

TOOLS

- tires & wheels
- axles, hubs & springs
- tongue accessories
- hitches
- electrical
- brake parts
- trailer hardware
- locks & pins
- towing & loading
- tie downs
- tools
- chemicals

HYDRAULIC BRAKE BLEEDER

Provides a simple method of checking needle and seat pressure as well as impulse diaphragms, etc.



678143 17.99 E

TWO-STROKE LEAK DOWN TESTER (DETECTOR)

- Designed to check for air leaks in 2-stroke engines
- Includes air pressure gauge, pump-up bulb and most fittings and adapters for single and twin cylinder 2-stroke motorcycle engines
- Packed in a convenient carry box, complete with instructions



678071 308.99 E

COMPRESSION TESTER

- Designed to check cylinder compression
- Contains hoses for 10, 12 & 14mm spark plug applications
- Features a quick disconnect with a pressure release valve and a 3000 lb. gauge
- Packed in a convenient carry box, complete with instructions



678188 119.99 E

NITROGEN SHOCK GAUGE & FILLER

- 300 PSI capacity
- Bleeder valve & T-handle plunger pin chuck
- Swivel chuck has a 12" flexible hose
- Instructions, carrying box and Schrader valve extension included (required on some Showa shocks)



680072 233.99 D

SYNCPRO CARB TUNER

- Precise four channel vacuum indicator designed specifically for intake synchronization of engines with multiple carburetors or throttle bodies (max vacuum range 40cm Hg)
- New mercury-free design uses non toxic manometer fluid
- For use with any 2, 3 or 4 cylinder four stroke motorcycles
- Spill proof design means the tool can be stored in a horizontal or vertical position
- Rugged, impact resistant ABS enclosure with convenient storage area for adapters
- Includes manometer fluid, hoses, 5mm adapters, in-line restrictors and instructions
- Unaffected by barometric pressure changes
- Includes hang hook to clip onto the handlebars for easy use
- Easy to read scale for precise synchronization
- Rubber feet on enclosure bottom helps prevent sliding
- Optional 6mm adapters are available for use on most Yamaha models
- 5mm adapters are used on many Honda and Suzuki models
- Most Kawasaki models do not need adapters



678411 102.99 A

6MM CARB ADAPTOR SET

Replacement carb adaptor set for use with vacuum carb synchronization tools

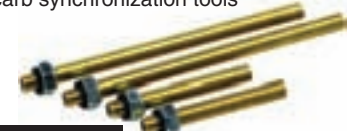

678040 10.50 E

SYNC PROMANOMETER FLUID REFILL

- Non-toxic / Mercury free
- Motion Pro blue color
- SyncPro Manometer Fluid Refill does NOT work with older Motion Pro mercury carburetor synchronizers



678415 6.99 E

TRAILER

STEEL O-CLIPS & PINCER TOOL

PINCER TOOL

O-clip pincer tool is available to install and remove the O-clips

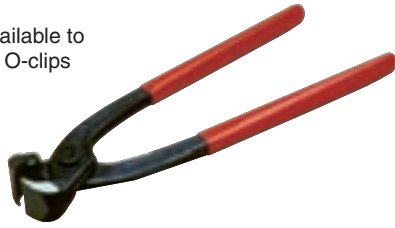

670024 19.50 E

FUEL HOSE CLIP

670025	5/16" clips (for 3/16" hose)	6.99	E
670026	7/16" clips (for 1/4" hose)	6.99	E
670027	1/2" clips (for 5/16" hose)	7.50	E



STEPLESS CLAMP FUEL LINE FITTINGS KIT

- Convenient kit includes 70 pcs of hardware, a Motion Pro Side Jaw Pincer tool, and a convenient fuel line clamp size chart
- Kit includes following items packed in a convenient storage box:

Contains:

142612	Stepless Clamps, 7.8mm to 9.5mm range,	10 pcs
143502	Stepless Clamps, 9.6mm to 11.3mm range,	10 pcs
142613	Stepless Clamps, 10.3mm to 12.8mm range,	10 pcs
142614	Stepless Clamps, 10.8mm to 13.3mm range,	10 pcs
142615	Stepless Clamps, 12.0mm to 14.5mm range,	10 pcs
143503	Stepless Clamps, 13.2mm to 15.7mm range,	10 pcs
142616	Stepless Clamps, 14.8mm to 18.0mm range,	10 pcs
12-0073	Side Jaw Pincer Tool	



143504 124.99 E



MINI BLEEDERS

- Combines wrench and bleeder valve into one convenient and compact tool
- Bleeds brake systems and hydraulic clutch systems
- Internal check valve for fast easy bleeding
- Anodized billet aluminum handle with chromoly steel body
- Compact size for tight spaces
- High quality internal seal
- Multi position handle



DESCRIPTION	PART #		
8 mm	143835	26.99	E
10 mm	144149	26.99	E
11 mm	144150	26.99	E
3/8 in.	144162	26.99	E



MICRO BLEEDERS

- Ultra-compact, low profile design is only 11 mm high installed
- Stainless steel body is stronger and will not corrode
- Easy to install, simply replace the OE bleeder screw with the Micro Bleeder
- Reduces harshness caused by air build-up
- Allows bleeding of air pressure without tools
- One of the easiest bolt-on upgrades you can make to your forks
- Kit includes two bleeder valves

DESCRIPTION	PART #		
M5x0.8 for Shawa (Gold)	144190	14.99	E
M5x0.8 for KYB (Silver)	144194	14.99	E



SHOCK SPANNER PUNCH

- Ideal tool for turning hard to reach lock ring and preload ring on rear shocks
- Angled brass tip gives secure bite and protects ring from damage
- Heavy duty construction
- Long shaft to reach hard to get at shocks



143457 17.99 E

- tires & wheels
- axles, hubs & springs
- tongue accessories
- hitches
- electrical
- brake parts
- trailer hardware
- locks & pins
- towing & loading
- tie downs
- tools
- chemicals

TRAILER

- tires & wheels
- axles, hubs & springs
- tongue accessories
- hitches
- electrical
- brake parts
- trailer hardware
- locks & pins
- towing & loading
- tie downs
- tools
- chemicals

HARDWARE ASSORTMENTS



200 PC SPRING ASSORTMENT



W5200 9.05 L

560 PC COTTER PIN ASSORTMENT



W5205 10.70 L

150 PC COTTER PIN ASSORTMENT



W5206 14.20 L

150 PC HAIR PIN ASSORTMENT



W5210 9.20 L

300 PC E-CLIP ASSORTMENT



W5208 10.20 L

300 PC SNAP RING ASSORTMENT



W5212 9.50 L

26 PC HOSE CLAMPS



W5348 8.95 L

347 PC NUT & BOLT ASSORTMENT - METRIC



W52221 7.30 L

70 PC GREASE FITTING ASSORTMENT



W5218 7.95 L

200 PC HEX HEAD DRILL SCREW ASSORTMENT



W5220 10.90 L

1200 PC NUT, BOLT, & WASHER ASSORTMENT



W5226 39.95 L

720 PC WASHER ASSORTMENT



W5215 15.20 L

500 PC RIVET ASSORTMENT



W5228 14.95 L

150 PC WING NUT ASSORTMENT

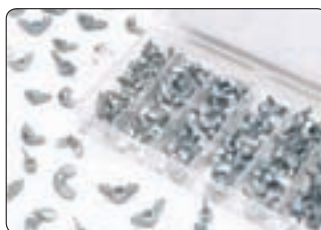

W5219 13.10 L

347 PC NUT & BOLT ASSORTMENT - SAE



W52211 7.30 L

285 PC MULTI-USE ELECTRICAL REPAIR KIT



W5207 38.60 L

160 PC WIRE TERMINAL ASSORTMENT



W52131 17.10 L

120 PC FUSES



W5368 13.95 L

120 PC MINI BLADE STYLE FUSE ASSORTMENT



260088 12.95 G

TRAILER

METRIC KIT REPLACEMENT HARDWARE

Priced per package • Sold in packages of 10 only • All the popular metric nuts, bolts & washers that fit your atv, motorcycle and snowmobile

PART #	DESCRIPTION & (HEAD SIZE)		PART #	DESCRIPTION & (HEAD SIZE)		PART #	DESCRIPTION & (HEAD SIZE)	
MP0005	Nut, 5mm (8mm)	0.80 G	MP0110	Nut, Flange 10mm (14mm)	2.86 E	MP0206	Nut, Nylock 6mm (10mm)	1.23 E
MP0006	Nut, 6mm (10mm)	1.23 E	MP0112	Nut, Flange 12mm (17mm)	3.83 E	MP0208	Nut, Nylock 8mm (12mm)	1.89 E
MP0008	Nut, 8mm (12mm)	1.57 G	MP0405	Nut, Acorn 5mm (8mm)	1.70 G	MP0210	Nut, Nylock 10mm (14mm)	3.52 E
MP0010	Nut, 10mm (14mm)	1.89 E	MP0406	Nut, Acorn 6mm (10mm)	2.51 E	MP1004	Washer, Flat 4mm	0.60 G
MP0012	Nut, 12mm (17mm)	3.83 E	MP0408	Nut, Acorn 8mm (13mm)	2.23 E	MP1005	Washer, Flat 5mm	0.69 H
MP0306	Nut, Fuji-Lock 6mm (10mm)	3.83 E	MP0410	Nut, Acorn 10mm (14mm)	4.17 G	MP1006	Washer, Flat 6mm	0.92 E
MP0308	Nut, Fuji-Lock 8mm (13mm)	4.99 G	MP0412	Nut, Acorn 12mm (17mm)	5.14 G	MP1008	Washer, Flat 8mm	1.57 G
MP0310	Nut, Fuji-Lock 10mm (17mm)	6.50 G	MP36251	Washer, fender 6mm	1.57 G	MP1010	Washer, Flat 10mm	1.57 G
MP0312	Nut, Fuji-Lock 12mm (19mm)	13.26 E	MP38251	Washer, fender 8mm	1.49 G	MP1012	Washer, Flat 12mm	1.75 G
MP2004	Washer, Lock 4mm	0.89 G	MP0610	Bolt, m6x10 (10mm)	1.60 G	MP0415	Bolt, m4x15 (12mm)	1.35 G
MP2005	Washer, Lock 5mm	1.71 G	MP0615	Bolt, m6x15 (10mm)	1.75 G	MP0425	Bolt, m4x25 (12mm)	3.55 L
MP2006	Washer, Lock 6mm	1.25 G	MP0620	Bolt, m6x20 (10mm)	1.99 G	MP0810	Bolt, m8x10 (12mm)	4.17 G
MP2008	Washer, Lock 8mm	2.15 G	MP0625	Bolt, m6x25 (10mm)	1.99 G	MP0815	Bolt, m8x15 (12mm)	3.30 G
MP2010	Washer, Lock 10mm	1.80 G	MP0630	Bolt, m6x30 (10mm)	2.35 G	MP0820	Bolt, m8x20 (12mm)	3.25 G
MP2012	Washer, Lock12mm	3.55 G	MP0635	Bolt, m6x35 (10mm)	2.49 G	MP0825	Bolt, m8x25 (12mm)	3.49 G
MP0520	Bolt, m5x20 (8mm)	1.49 G	MP0640	Bolt, m6x40 (10mm)	2.75 G	MP0830	Bolt, m8x30 (12mm)	3.50 G
MP0525	Bolt, m5x25 (8mm)	1.59 G	MP0645	Bolt, m6x45 (10mm)	4.17 G	MP0835	Bolt, m8x35 (12mm)	5.80 G
MP0530	Bolt, m5x30 (8mm)	4.05 L	MP0650	Bolt, m6x50 (10mm)	2.50 G	MP0840	Bolt, m8x40 (12mm)	4.50 G
MP1020	Bolt, m10x20 (14mm)	7.59 G	MP1220	Bolt, m12x20 (17mm)	14.20 L	MP0845	Bolt, m8x45 (12mm)	6.43 E
MP1025	Bolt, m10x25 (14mm)	7.74 G	MP1230	Bolt, m12x30 (17mm)	16.15 L	MP0850	Bolt, m8x50 (12mm)	5.60 G
MP1030	Bolt, m10x30 (14mm)	8.64 E	MP1816	Bolt, Flange m8x16 (10mm)	2.99 G	MP2610	Screw, Allen Head m6x10	2.80 G
MP1035	Bolt, m10x35 (14mm)	9.99 G	MP1820	Bolt, Flange m8x20 (10mm)	2.99 G	MP2612	Screw, Allen Head m6x12	2.74 G
MP1040	Bolt, m10x40 (14mm)	11.39 G	MP1825	Bolt, Flange m8x25 (10mm)	3.49 G	MP2616	Screw, Allen Head m6x16	3.11 G
MP1045	Bolt, m10x45 (14mm)	12.50 G	MP1830	Bolt, Flange m8x30 (10mm)	3.50 G	MP2618	Screw, Allen Head m6x18	3.46 E
MP1050	Bolt, m10x50 (14mm)	12.50 G	MP1835	Bolt, Flange m8x35 (10mm)	3.99 G	MP2620	Screw, Allen Head m6x20	3.46 E
MP1610	Bolt, Flange m6x10 (8mm)	1.99 G	MP1840	Bolt, Flange m8x40 (10mm)	3.99 G	MP2625	Screw, Allen Head m6x25	3.80 G
MP1616	Bolt, Flange m6x16 (8mm)	2.25 G	MP1850	Bolt, Flange m8x50 (10mm)	5.25 G	MP2630	Screw, Allen Head m6x30	4.17 G
MP1620	Bolt, Flange m6x20 (8mm)	2.35 G	MP3608	Screw, Pan Head m6x8	1.99 G	MP2635	Screw, Allen Head m6x35	4.85 G
MP1625	Bolt, Flange m6x25 (8mm)	2.30 G	MP3612	Screw, Pan Head m6x12	2.25 G	MP2640	Screw, Allen Head m6x40	4.85 G
MP1630	Bolt, Flange m6x30 (8mm)	2.65 G	MP3616	Screw, Pan Head m6x16	2.25 G	MP2645	Screw, Allen Head m6x45	5.20 G
MP1635	Bolt, Flange m6x35 (8mm)	2.75 G	MP3618	Screw, Pan Head m6x18	3.99 G	MP2650	Screw, Allen Head m6x50	5.57 G
MP1640	Bolt, Flange m6x40 (8mm)	2.49 G	MP3620	Screw, Pan Head m6x20	2.75 G	MP2655	Screw, Allen Head m6x55	5.92 E
MP1645	Bolt, Flange m6x45 (8mm)	2.99 G	MP3625	Screw, Pan Head m6x25	2.99 G	MP2660	Screw, Allen Head m6x60	6.75 G
MP2820	Screw, Allen Head m8x20	5.80 G	MP3630	Screw, Pan Head m6x30	3.25 G	MP2665	Screw, Allen Head m6x65	7.05 G
MP2825	Screw, Allen Head m8x25	6.29 E	MP3635	Screw, Pan Head m6x35	3.60 G	MP2670	Screw, Allen Head m6x70	7.50 G
MP2830	Screw, Allen Head m8x30	6.99 G	MP3640	Screw, Pan Head m6x40	3.99 G	MP3510	Screw, Pan Head m5x10	1.25 G
MP2835	Screw, Allen Head m8x35	5.50 G	MP3645	Screw, Pan Head m6x45	4.10 G	MP3512	Screw, Pan Head m5x12	1.75 G
MP2840	Screw, Allen Head m8x40	5.89 G	MP3650	Screw, Pan Head m6x50	4.39 G	MP3516	Screw, Pan Head m5x16	1.99 G
MP2845	Screw, Allen Head m8x45	6.20 G	MP3655	Screw, Pan Head m6x55	7.74 G	MP3520	Screw, Pan Head m5x20	2.25 G
MP0105	Nut, Flange 5mm (8mm)	0.99 G	MP3660	Screw, Pan Head m6x60	8.20 G	MP3525	Screw, Pan Head m5x25	2.35 G
MP0106	Nut, Flange 6mm (10mm)	1.57 G	MP0204	Nut, Nylock 4mm (7mm)	0.99 G	MP3530	Screw, Pan Head m5x30	2.49 G
MP0108	Nut, Flange 8mm (12mm)	2.23 E	MP0205	Nut, Nylock 5mm (8mm)	0.99 G			

TOOL PACK HARDWARE KIT CARD OF 12 PACKS

- Display holds 12 hardware kits
- Kits have 22 pieces that contain nuts, bolts, and washers most commonly needed for Off-Road/MX repairs
- Designed for modern off-road, MX and Dual Sport motorcycles
- Developed to carry in your T6 Tool Pack for trail side repairs, but equally as useful in your toolbox



MP1200 59.88 G



METRIC HARDWARE KITS & REPLACEMENT HARDWARE

- Kits feature grade 5 hardware with a zinc finish
- Sold in an adjustable section box measuring 13.5" x 9.25"

ALL KITS ARE 250 PIECES

PART #	DESCRIPTION	
MP0200	Hardware Kit, Standard Metric Bolts: An assortment of 6mm bolts from 6x10 through 6x45, 8mm bolts 8x10 through 8x50 & 10mm bolts 10x20 through 10x50 (all in 5mm increments)	134.99 G
MP0100	Hardware Kit, Metric Nuts: An assortment of standard, nylock, flange, fuji lock and low dome acorn nuts	99.99 G
MP0400	Hardware Kit, Allen Bolts: An assortment of 6mm allen head bolts from 6x10 through 6x70, 8mm allen head bolts from 8x20 through 8x45 (all in 5mm increments)	129.99 G
MP0300	Hardware Kit, Flange Head Bolts: An assortment of 6mm flange head bolts from 6x10 through 6x45 and 8mm flange head bolts from 8x16 through 8x50 (all in 5mm increments)	51.99 G
MP0000	Hardware Kit, Washers: An assortment of flat & lock washers from 4mm through 12mm. Includes 6mm (19mm outside dia.) and 8mm (22mm outside dia. fender washers)	49.99 G
MP0500	Hardware Kit, Pan Head Screws: Assortment of 5mm pan head screws from 5x10 through 5x30 (in 5mm increments) 6mm pan head screws including 6x8, 6x12, 6x16, 6x18, then 6x20 through 6x60 (in 5mm increments)	78.99 G
MP1100	Hardware Kit, Off-road: All essential fasteners for an off-road mechanic's shop	42.99 E

- tires & wheels
- axles, hubs & springs
- tongue accessories
- hitches
- electrical
- brake parts
- trailer hardware
- locks & pins
- towing & loading
- tie downs
- tools
- chemicals

TRAILER

- tires & wheels
- axles, hubs & springs
- tongue accessories
- hitches
- electrical
- brake parts
- trailer hardware
- locks & pins
- towing & loading
- tie downs
- tools
- chemicals

MOTORSPORTS CONTAINERS

HOSE SOLD SEPARATELY

- Ergonomically contoured handle and bottom grip for easy pouring.
- Extra large cap with rubber o-ring gasket.
- Made from virgin density polyethylene.
- Adjustable screw on air vent.
- Containers have accurate graduated marks indicating gallons and liters.
- 5 gallon capacity.
- Hose sold separately (Part #650643)
- Three year warranty



SQUARE CONTAINERS



Red 650637 32.95 D



White 650636 32.95 D



Blue 650638 32.95 D

* For each pink container sold, a percentage of the proceeds will be donated by VP Racing Fuels to support the cancer prevention research, education and community outreach programs of the Prevent Cancer Foundation. The VP Breast Cancer Awareness Motorsport Containers carry a 3-year limited warranty against cracks, leaks or splitting. Hoses not included.

NOTE: The VP Breast Cancer Awareness Motorsport Container is intended only for use as a rapid refueling device for racing vehicles used in professional off road and closed course competition racing events. It is NOT a portable fuel container as described by ASTM, EPA, ARB or other state or federal agencies. Intended for racing fuel only; not to be used for street legal fuels.



Pink 650646* 32.95 D

Like all VP Sportsman's Containers, the rugged new Camo container is made with only the highest quality virgin high-density polyethylene, including 30% more material than standard containers to withstand the roughest treatment. The containers are subjected to a 15-point quality test and carry a 3-year limited warranty. They feature an ergonomically contoured handle, bottom grip for easy pouring and a non-breakable multipurpose cap with rubber gaskets.

Excellent for storage & transport of:

- Water
- Automotive & industrial fluid
- Deer corn, milo & oats
- Feed pellets, bird seed
- Rock salt
- Oil & liquid absorbents

Great for mixing/ dispensing:

- Animal attractants & feed
- Herbicides, insecticides



Camo 650659 32.95 D

MOTORSPORTS CONTAINERS

- Ergonomically contoured handle and bottom grip for easy pouring.
- Extra large cap with rubber o-ring gasket.
- Made from virgin density polyethylene.
- Adjustable screw on air vent.
- Containers have accurate graduated marks indicating gallons and liters.
- 5 gallon capacity.
- Hose sold separately (Part #650643)
- Three year warranty

HOSE SOLD SEPARATELY



ROUND CONTAINERS



Green 650639 32.95 D

Yellow 650640 32.95 D

Orange 650641 32.95 D

White 650642 32.95 D



Blue 650647 32.95 D



Red 650648 32.95 D



Orange/Black 650660 32.95 D

REPLACEMENT PARTS

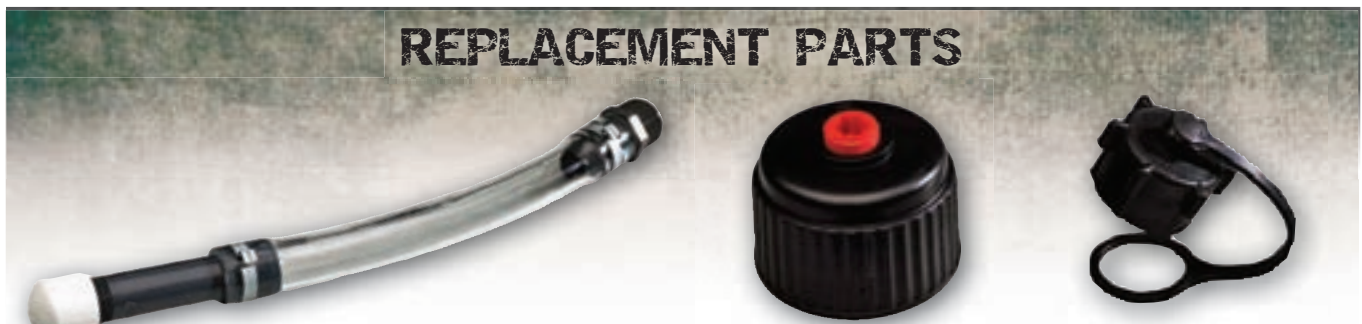

Hose 650643 9.95 D

Cap 650644 9.45 D

Vent Cap 650645 1.95 D

- tires & wheels
- axles, hubs & springs
- tongue accessories
- hitches
- electrical
- brake parts
- trailer hardware
- locks & pins
- towing & loading
- tie downs
- tools
- chemicals

TRAILER

- tires & wheels
- axles, hubs & springs
- tongue accessories
- hitches
- electrical
- brake parts
- trailer hardware
- locks & pins
- towing & loading
- tie downs
- tools
- chemicals



REMOVES WATER FROM FUEL

The Fuel Filter Funnel by Mr. Funnel is a heavy-duty, anti-static, and fast flow funnel with built-in filter technology. When fuel is poured through the Fuel Filter Funnel, water and debris will not pass through the filter's fluoropolymer-coated stainless steel filter. Only filtered fuel flows through to your engine, improving its efficiency, durability, and proper operation. The sump area collects the deflected water and debris for proper disposal. The Fuel Filter Funnel by Mr. Funnel will filter gasoline, diesel, heating oil, kerosene and 2-cycle mixed gas.



What Model Do I Need?

The Mr. Funnel Fuel Filter comes in four different fast-flow models (See below). Models differ mainly on flow rate. If your need is to transfer five gallons or less of fuel, then the F1 and F3 are for you. If you are transferring more than 5 gallons, then the F8 and F15 are right for you. Our F15 is our fastest flow model at up to 15 gallons per minute! This model can also be used at a fuel pump. Get your Mr. Funnel Fuel Filter today, and keep your engine running smooth!



MODEL: F1
for transferring five gallons or less of fuel
Height: 6"
Diameter: 3.5"
Flow Rate: 2.5 gpm

232000 19.55 B



MODEL: F3
for transferring five gallons or less of fuel
Height: 8.75"
Diameter: 5.5"
Flow Rate: 3.5 gpm

232001 25.75 B

Flexible Spout Extension
for use with 232001 funnel only



232004 6.15 B



MODEL: F8
for transferring more than five gallons of fuel
Height: 10"
Diameter: 8.5"
Flow Rate: 5.0 gpm

232002 37.05 B



Our fastest flow model, this model can also be used at a fuel pump.

MODEL: F15
for transferring more than five gallons of fuel
Height: 10"
Diameter: 8.5"
Flow Rate: 12 gpm

232003 70.00 B



MODEL: F1NC
medium non-conductive portable fuel filter
Height: 9"
Diameter: 5.5"
Flow Rate: 3.5 gpm

232023 11.95 G



MODEL: F3NC
small non-conductive portable fuel filter
Height: 6"
Diameter: 3.5"
Flow Rate: 2.5 gpm

232024 15.95 G

tires & wheels
axles, hubs & springs
tongue accessories
hitches
electrical
brake parts
trailer hardware
locks & pins
towing & loading
tie downs
tools
chemicals

TRAILER

QUICKFILL® FUNNEL

- Speed channels maximize flow rate
- Distinct hand hold for a better grip
- No-mess splash guard



232007 2.95 G

GAS GAUGE FUNNEL™

- Floating indicator signals when gas tank is full, helps prevent spills and overfills
- Great for lawn mowers and more
- Clip-strip included



232008 3.95 G

TIGHT SPOT FUNNEL

- Fits Where Other Funnels Don't™
- Ideal for tight engine compartments
- Flexible design fits into tight spots



232009 3.95 G

2 QUART FUNNEL WITH SCREEN

- 2 quart capacity for large volume
- Filter screen included to clean fluids
- Built-in hang tag



232010 3.95 G

1 PINT FUNNEL WITH SCREEN

- 1 pint capacity, great for smaller engines
- Filter screen included to clean fluids
- Built-in hang tag



232011 2.95 G

LOCKING OIL FUNNEL™

- Lock-in oil filler hole
- Funnel holds bottle while pouring
- No waste and no-mess quick pouring



232012 1.95 G

TRANSMISSION FUNNEL

- 18" funnel made from durable high quality copolymer plastic
- Designed for hard to reach applications
- Perfect for transmission fluid



232013 2.95 G

MULTI-TASK 5-IN-1 FUNNEL™

- Holds one quart oil bottle
- Three interchangeable spouts, including the Flexi-Spout
- Nestable



232014 5.95 G

SUPER MULTI-PURPOSE FUNNEL™

- Large size (18") for multiple applications
- Perfect for transmissions and other engine fluids
- High perceived value allows for higher retail price points



232015 3.95 G

- tires & wheels
- axles, hubs & springs
- tongue accessories
- hitches
- electrical
- brake parts
- trailer hardware
- locks & pins
- towing & loading
- tie downs
- tools
- chemicals

FLEX FUNNEL™

- Ideal for hard to reach applications
- Distinct hand holds for a better grip
- Detachable flexible spout



232016 3.95 G

2 PIECE FUNNEL SET

- Multi-Purpose and Big Mouth funnel combo
- No-mess splash guards
- Covers all general purpose fluid applications



232017 2.95 G

3 PIECE SET GENERAL PURPOSE FUNNELS

- Includes small, medium & large funnels



232018 3.95 G

TRANSMISSION FLUID/GEAR OIL SPOUT

- On/off adjustable flow spout
- Reduced tip for transmission filler tubes
- Fits quart or gallon containers



232019 4.95 G

NO SPILL OIL SPOUT™

- Twist on, twist off
- No Spills, No Mess!™
- Adjustable built-in valve



232020 2.95 G

SHAKER SIPHON™

- Moves up to 3.5 gallons a minute
- 6 foot anti-static tube
- Perfect for home, auto, ranch, marine or farm



232021 12.95 G

SUPER SIPHON™

- Clear tube to view liquid flow
- Safe and easy to use
- Perfect for transferring all types of liquids



232022 5.95 G

PLASTIC FUNNEL W/ 18" SPOUT

- 6 Diameter funnel
- 18 Flexible spout



260112 1.95 G

2 PIECE FLEX FUNNEL W/HANDLE

- Removable spout for multiple applications
- Easy hold handle



260113 2.95 G

TRAILER

STA-DRI FUEL DRYER NOW IN PROTECTIVE TUBE!

- Don't let water contaminated fuel ruin an engine or freeze up a fuel line
- Stop water problems by trapping it inside the Sta-Dri water cell before it enters your fuel system
- 1" X 9" nylon bag in tube
- Bag can be dried and reused
- Bag weighted to stay at bottom of tank



STD100 11.95 G



PLASTIC MEASURING CONTAINER

- Perfect for mixing and measuring gas and oil
- 2 sizes available



500 ml, 17 oz **62-12061 5.95 L**
250 ml, 8.5 oz **62-12062 4.95 L**

RATIO-RITE PERFECT GAS/OIL MIXTURE MEASURING CUP

- Get a perfect mix every time
- Fill your polypropylene Ratio-Rite to the pre-calibrated ratio mark and pour into gas
- Ratios are from 16:1 to 44:1 for 1, 1-1/2, 2, 2-1/2 gal.
- Calibrations also include oz., cc's, and pints on the opposite side for transmission oil, for oil, etc.
- Total capacity is 24 oz.



REPLACEMENT LID FOR RR100

- Sold separately
- Seals the cup from dirt and spillage
- Lid can be attached to cup handle to keep from being misplaced



RR105 2.55 L

RR100 6.15 L

FUNNELS

- Heavy duty USA made
- Polyethylene construction
- Fine mesh brass screen



2 Quart **PT493 3.99 G**

Fill All **PT520 5.39 G**

2 QUART PLASTIC FUNNEL

- Rugged, corrosion resistant all purpose funnel
- Complete with fine mesh straining screen and handy hanging tab
- Capacity indicates what the funnel will hold when the outlet is blocked



W54276 3.60 L

ALL PURPOSE FUNNELS



1/2 Pint
W4007 1.00 L



1 Pint
W4015 1.30 L



1 Quart
W4064 2.95 L



18 in.
W40340 3.60 L

- tires & wheels
- axles, hubs & springs
- tongue accessories
- hitches
- electrical
- brake parts
- trailer hardware
- locks & pins
- towing & loading
- tie downs
- tools
- chemicals

TRAILER

HOUR METERS • MINI TACH • STOP WATCH

- tires & wheels
- axles, hubs & springs
- tongue accessories
- hitches
- electrical
- brake parts
- trailer hardware
- locks & pins
- towing & loading
- tie downs
- tools
- chemicals

TRAILER

HOUR METER

- Track the service life of your vehicle - track your oil changes, valve adjustments, spark plugs, etc.
- Easy installation - peel & stick, no wiring necessary, or attach with enclosed hardware, and no battery required, connects to spark plug wire
- Works on any gas engine
- Records & displays to 9,999.9 hours
- Hour glass symbol appears & flashes on/off to indicate counting time
- Automatic roll over
- 100% epoxy encapsulated casing resists water
- One year warranty



HL8063 35.99 G



RE-SETTABLE HOUR METER DIRT BIKE, ATV & SNOWMOBILES

- Use on any gasoline engine 2/4 stroke
- Flashes "Clean Air Filter" at 5 hours
- Flashes "Change Oil" every 10 hours
- Flashes "Valve Service" every 20 hours
- All services count down the last 10 hours
- All services are easily reset with a touch of a button
- Timer Mode allows you to record individual sessions
- Total hours accumulated is not resettable



HL8067 39.99 G



HOUR/TACH METER

- Has same features as hour meter plus tachometer feature
- Works on any gas engine up to 2 cylinders and 9000 rpm
- Firing pattern 1 spark = 1rpm
- Resolution 10 RPMs
- Maximum RPMs 9000
- Suitable for all single and twin, two or four cycle gasoline engines operation within specified tachometer firing pattern



HL8061 35.99 G



VIBRATION METER

- Track the service life of all non-engine applications - automatic vibration activated recording
- Easy installation - peel and stick, no wiring necessary, or attach with enclosed hardware
- Records and displays to 9,999.9 hours
- Hour glass symbol appears and flashes on/off to indicate counting time
- Automatic roll over / Resolution 0.1 hour
- 100% epoxy encapsulated casing resists water
- No power required - sealed waterproof lifetime battery



HL8065 47.40 L



ROBIC STOP WATCH

- Easy to use timer allows you to focus on the event or activity
- Includes Event-Lap/Split Lap Counter
- Ultra precise multi-mode stopwatch with memory recall and lap counter
- Lap, split or event timing
- Five memory recall
- Auto lap counter up to 99
- Auto lap/Split release
- 1st-5th place times
- Water resistant to 30 meters
- Break-Away safety lanyard
- Uses CR-2032 Lithium battery



HL8100 35.99 L



HOLESHOT

MINI TACH

This Mini-Tach is the ultimate tuning device! It accurately records up to 10,000 RPMs and also meters total engine run time. RPM is recorded as the engine runs; engine run time is displayed when the engine is off. This is the best way to determine proper sled gearing, and it's also an excellent way to monitor engine use for proper on-time maintenance. Mini-Tach will work on all 1 or 2 cylinder 4-stroke engines with electronic ignition. Installs in just minutes with no special tools or mechanical experience.



770295 69.95 G

HOUR/TACH ADJUSTABLE METER

- Includes log book
- rack your service and settings
- Adjustable input and re-settable Max RPM
- Works on all gasoline engines
- No battery or ground wire required
- Easy installation
- 100% epoxy encapsulated cases are water resistant
- Record and display in increments of .01 hours up to 9,999.9 hours
- Hourglass symbols appear and flash on/off to indicate counting time
- Automatic roll-over



109000 36.95 G

HOUR METER

- Includes log book
- rack your service and settings
- Adjustable input and re-settable Max RPM
- Works on all gasoline engines
- No battery or ground wire required
- Easy installation



109002 36.95 G



INSTRUMENT STYLE BRACKET

- Fits standard Wiseco hour meter or tachometer



109001 9.95 G





POLYETHYLENE RIP-STOP TARPS

• 5 oz. polyethylene • Bright blue • 8 X 8 weave • Grommets every 3 feet • Waterproof • Tear proof

PART #	CUT SIZE		
BPT57	5 X 7	1.95	G
BPT810	8 X 10	4.40	G
BPT815	8 X 15	6.60	G
BPT1012	10 X 12	6.55	G
BPT1018	10 X 18	9.90	G
BPT1212	12 X 12	7.90	G
BPT1225	12 X 25	16.45	G
BPT1530	15 X 30	24.70	G
BPT1620	16 X 20	17.55	G
BPT2030	20 X 30	32.95	G
BPT2040	20 X 40	43.95	G

- tires & wheels
- axles, hubs & springs
- tongue accessories
- hitches
- electrical
- brake parts
- trailer hardware
- locks & pins
- towing & loading
- tie downs
- tools
- chemicals



BROWN/GREEN REVERSIBLE TARPS

• 10X10 Weave • Brown on one side/Green on the other • Blends in with spring and fall colors • Features strong plastic reinforced corners for added strength

PART #	CUT SIZE		
EK57030	6 X 8	5.75	G
EK57031	8 X 10	9.55	G
EK57032	10 X 12	14.40	G
EK57033	12 X 16	22.95	G
EK57034	12 X 20	28.75	G
EK57035	16 X 20	38.55	G
EK57036	18 X 24	51.75	G

HEAVY DUTY CAMO TARP

- 10 x 10 weave with reinforced corners
- Increased UV content for longer life
- Rust resistant grommets
- Lightweight and flexible easy storage

ERICKSON

PART #	CUT SIZE		
EK57005	10 X 12	25.70	G

HEAVY DUTY MESH TARPS

The mesh design allows the air to flow through and works great for covering loads that need containment but not water repellency. The flapping we see with most tarps is drastically reduced with the mesh design.

Ideal for:

- Trailer covers
- Dump truck covers

ERICKSON

PART #	CUT SIZE		
EK57056	6 X 8	29.45	G
EK57057	8 X 10	42.70	G
EK57058	10 X 12	58.80	G
EK57059	12 X 16	86.75	G

RATCHETING TIE DOWN WITH WEB CLAMP

Erickson's Strap Trap holds the excess web not being used by simply clamping it into the ratchet handle so it can't blow in the wind. the clamping mechanism is much like a mouse trap, lift the spring loaded clamp and place the folded webbing under the clamp, release the strap trap and you have trapped the excess web.

SIZE	MAX LOAD	SAFE WORKING LOAD	QTY	MFG #	PART #	
1" x 15'	1,500#	500#	1 pack	31350	EK31350	10.60 G
1" x 8'	1,500#	500#	2 pack	31351	EK31351	16.75 G
1" x 10'	1,500#	500#	4 pack	31352	EK31352	33.10 G



TRAILER

- tires & wheels
- axles, hubs & springs
- tongue accessories
- hitches
- electrical
- brake parts
- trailer hardware
- locks & pins
- towing & loading
- tie downs
- tools
- chemicals

ADJUSTABLE TARP STRAP

24" long • 6 per package

Adjustable tarp straps have heavy reinforced holes every 6" along the strap to hook back into or move the end hook to make it shorter.



ERICKSON

EK6724 11.75 pkg G

TARP CLIP

Heavy duty nylon clip, sold each



ERICKSON

EK51029 2.45 EA G

BLACK RUBBER TIE DOWNS

- Quick and easy, just hook and secure into place
- Extra heavy duty 3/4" flat rubber tie downs with heavy reinforced ends and heavy 2-1/2" steel hooks
- Maximum resistance to all weather conditions

ERICKSON



LP13910	10"	1.39	L
LP13915	15"	1.69	L
LP13921	21"	2.19	L
LP13931	31"	2.79	L
LP13941	41"	2.99	L

BLACK RUBBER TARP STRAPS

These rubber bungee cords are a versatile tie down strap and are easily stored. These rubber straps have a 2" S-Hook on each end.



Package of 10
Includes:

- (4) - 9"
- (2) - 15"
- (2) - 21"
- (2) - 31"

ERICKSON

EK06610 14.45 pkg G

FLAT BUNGEE CORDS

- A hardened metal wire form is placed in the center of the moulded polycarbonate hook - making it super strong
- Sold each

ERICKSON

12"	EK06912	2.90	G
18"	EK06918	3.15	G
24"	EK06924	3.25	G
30"	EK06930	3.45	G
36"	EK06936	3.60	G
42"	EK06942	3.85	G



DELUXE BUNGEE CORDS

- Talk about quality! That's what the deluxe bungee is all about
- An Industrial grade bungee comes secured to a moulded polycarbonate hook with a hardened wire insert moulded in
- 3 sizes available in 3 colors

ERICKSON

12", Red	EK07012	2.55	G
24", Blue	EK07024	3.10	G
36", Yellow	EK07036	3.55	G



TRAILER

E-TRACK ADJUSTABLE TIRE STRAP

- For standard tires
- Sold each
- Yellow

ERICKSON



EK08314 42.75 ea G

ADJUSTABLE TIRE STRAP W/RATCHET

- 10,000#
- Adjustable tire strap, 1 pack
- Yellow

ERICKSON



EK08522 46.60 ea G

10,000# ADJUSTABLE TIRE STRAP W/RATCHET



ERICKSON

EK58522 39.95 ea G

CHEMICALS



- tires & wheels
- axles, hubs & springs
- tongue accessories
- hitches
- electrical
- brake parts
- trailer hardware
- locks & pins
- towing & loading
- tie downs
- tools
- chemicals



BEL-RAY

BEL-RAY BRAKE & PARTS CLEANER

Bel-Ray Brake & Parts Cleaner is a unique low VOC product specifically designed to clean and degrease all metal surfaces. This unique product will clean brake components and remove carbon and oil build-up. It dries in seconds leaving no residue. Bel-Ray Brake & Parts Cleaner can be used to clean fouled spark plugs, carburetor parts, gear boxes, and other engine parts, as well as other areas that require a quick-drying spray. Should not be used on painted surfaces or come into repeated or prolonged contact with plastic or rubber materials.



400 ML/16 OZ (12/CASE)		MFG #	
620029	99080-A400	7.95	J



BEL-RAY 6 IN 1

Bel-Ray 6 in 1 contains anti-wear additives that provide high film strength to this exceptional penetrating and lubricating fluid. Bel-Ray 6 in 1 cleans as it lubricates, protects against rust and corrosion, displaces water, and reduces friction. Bel-Ray 6 in 1 will not harm electrical contacts, vinyl, wood or paint.



175 ML (12/CASE)		MFG #		400 ML (12/CASE)		MFG #	
620017	99020-A175W	5.80	J	620018	99020-A400W	7.95	J

BEL-RAY

'FLEX YOUR ENGINE' RACK

Metal display features:

- High quality, long-lasting construction
- Heavy-duty wheels for easy mobility
- Low square footage display (71"H, 27"W, 19"D)
- Aggressive, "Flex Your Engine" Design matches mainstream media campaign for customer awareness
- Limited quantities available

PART #	MFG #		
620000	90881-EACH	528.75	J



BEL-RAY COUNTER RACK

- High quality, long-lasting construction
- Rotating base for 360 (degree sign) access
- Low square footage display (16" H, 15" W, 14 3/4" D)
- Aggressive, "Flex Your Engine" design matches mainstream media campaign for customer awareness
- Limited quantities available

PART #	MFG #		
920176	MCOUNTER-BOXBR5	40.00	G



BEL-RAY



MARINE BIODEGRADABLE MULTIPURPOSE LUBRICANT

Marine Biodegradable Multipurpose Lubricant is a rapidly biodegradable, multi-purpose, penetrating lubricant that cleans, lubricates and protects. It contains superior anti-wear additives that provide high film strength and low film thickness to prevent metal-to-metal contact. Marine Biodegradable Multipurpose Lubricant displaces moisture and can be applied to wet surfaces. Marine Biodegradable Multipurpose Lubricant is greater than 60% biodegradable making it the perfect multipurpose lubricant option for recreational and commercial marine users.

175 ML (12/CASE)	MFG #	400 ML (12/CASE)	MFG #	4 LITER (4/CASE)	MFG #
620178	99704-A175W	10.95	J	620179	99704-A400W
		13.95	J	620180	99705-BT4
				66.95	J



MARINE SILICONE LUBRICANT

Marine Silicone Lubricant is a non-toxic, high viscosity, silicone fluid that is pearlescent in color, smooth, tacky and waterproof. It fights corrosion and lubricates wood, nylon, rubber, metals, canvas and leather. Marine Silicone Lubricant eliminates squeaking and binding.

175 ML (12/CASE)	MFG #	400 ML (12/CASE)	MFG #
620182	99707-A175W	7.95	J
620183	99707-A400W	8.95	J



MARINE WATERPROOF GREASE

Marine Waterproof Grease is a mineral oil based, aluminum complex grease. Because it is an aluminum complex grease, Marine Waterproof Grease exhibits all of the beneficial properties of that thickener, including being virtually waterproof. It is a severe duty grease providing maximum protection against wear, rust, corrosion and water washout. Marine Waterproof Grease is formulated to provide for wet-duty performance including the wheel bearings of boat trailers in fresh or salt water. Marine Waterproof Grease repels water and is an excellent seal for bushings, bearings, all chassis lubrication points.

14 OZ (12/CASE)	MFG #	3 OZ (24/CASE)	MFG #
620184	99710-CG	10.95	J
620185	99710-CG3OZ	4.95	J

BEL-RAY WATERPROOF GREASE

The legendary high-performance, general purpose grease. Superior water resistance, even in salt water, will ensure continued sealing and protection. Perfect for wheel bearings, headsets, shock linkages, swing arm pivots and other motorcycle, ATV, snowmobile and marine chassis lubrication points. Due to its aluminum complex formula, it won't melt or run out. Enhanced mechanical stability and special anti-wear additives protect and lubricate bearings for improved performance.

16 OZ (12/CASE)	MFG #	16 OZ CARTRIDGE (12/CASE)	MFG #
620169	99540-TB16W	9.95	J
620167	99540-CF14	8.50	J



- tires & wheels
- axles, hubs & springs
- tongue accessories
- hitches
- electrical
- brake parts
- trailer hardware
- locks & pins
- towing & loading
- tie downs
- tools
- chemicals

TRAILER

- tires & wheels
- axles, hubs & springs
- tongue accessories
- hitches
- electrical
- brake parts
- trailer hardware
- locks & pins
- towing & loading
- tie downs
- tools

RTV SEALANT - GRAY

- RTV sealant (gray) high viscosity gasket maker.
- OEM specified product
- Good elasticity
- Temperature, chemical, oil, water, coolant, and gasoline resistant
- Excellent as a general purpose LGM
- High resistance to heat and cold

DESCRIPTION	QTY/CS	PART #	MFG #		
3.8 oz	6	414000	TB1200GAU3Z	13.95	G



GROUND ONLY



GROUND ONLY

GASKET MAKER - GRAY

- High viscosity FIPG (form-in-place-gasket) gasket-maker
- OEM specified product
- Good adhesion properties in power-train and small engine applications
- Allows immediate service after application
- Non-slumping formulation 'holds-in-place'
- High resistance to engine and gear oil
- FIPG properties allow for greater 'gap' fill

DESCRIPTION	QTY/CS	PART #	MFG #		
5.3 oz	6	414001	TB1217H	18.95	G

chemicals

GASKET MAKER - BLACK

- High performance
- High viscosity
- High temp resistance
- High adhesion.
- High torque endurance
- High vibration endurance
- Liquid gasket maker used on more than 5 Million engines
- Non-slumping paste
- Highly effective In continuous vibrating conditions
- Good adhesion to plastic

DESCRIPTION	QTY/CS	PART #	MFG #		
3.5 oz	12	414002	TB4207B	31.95	G



GROUND ONLY

TRAILER

RTV SEALANT GRAY, LOW VISCOSITY, SOLVENTLESS

- High performance gasket maker
- Excellent heat/chemical and gear oil resistance

DESCRIPTION	QTY/CS	PART #	MFG #		
8.8 oz	6	414003	TB1215	28.95	G



GROUND ONLY

THREEBOND

ThreeBond

tires & wheels

axles, hubs & springs

tongue accessories

hitches

electrical

brake parts

trailer hardware

locks & pins

towing & loading

tie downs

tools

chemicals

TRAILER



GROUND ONLY

SUPER GLUE

- ThreeBond Super Glue attains practical use strength in a matter of seconds
- Contains no evaporative elements, so there's never any shrinkage to weaken bonding points
- Excellent for non-porous materials

DESCRIPTION	QTY/CS	PART #	MFG #	
2 Grams	36	TB1720	1742BT020	7.95 G

LIQUID GASKET

- Excellent padding properties make this semi-drying, visco-elastic sealer the perfect product for sealing joint surfaces with large clearance
- Special synthetic rubber provides excellent cushion to absorb vibrations and impacts without failure, esp. where coolants are involved
- O.E. motorcycle manufacturers have successfully used this high reliability liquid gasket in numerous applications
- Comes in 3.5 oz tubes



GROUND ONLY

DESCRIPTION	QTY/CS	PART #	MFG #	
3.5 oz	24	TB1184	1194A100GA	12.95 G

SYNTHETIC RUBBER ADHESIVE



GROUND ONLY

- ThreeBond 1521 is a contact cement which is a multi-purpose, rubber based adhesive that gives excellent bonding characteristics to a wide variety of materials including rubber, plastic, vinyl, metal, leather, woods, ceramics and more
- Provides a strong, waterproof bond and sets up within 5-10 minutes depending on temperature and humidity

DESCRIPTION	QTY/CS	PART #	MFG #	
5.3 oz	12	SOLD OUT	1521A150GM	
75 Grams	12	414004	7731521A75G	11.95 G

INSTANT ADHESIVE GEL TYPE

- Three Bond 1762 is a thixotropic gel
- Once applied, the gel stays in place and will not run off parts to be bonded

DESCRIPTION	QTY/CS	PART #	MFG #	
20 Grams	12	TB1762	1762B20G	12.95 G



GROUND ONLY

- tires & wheels
- axles, hubs & springs
- tongue accessories
- hitches
- electrical
- brake parts
- trailer hardware
- locks & pins
- towing & loading
- tie downs
- tools
- chemicals

SILICONE LIQUID GASKET

- ThreeBond 1211 Silicone Liquid Gasket is a tough durable sealer utilizing silicone rubber as a primary component
- White in color, its solventless, semi-drying and visco-elastic properties make it ideal for numerous applications where a long lasting, faultless seal is absolutely critical; as it comes in contact with air, it forms a rubberized, elastic mass impervious to vibrations and impacts
- Can be applied to flange surfaces and screw sections to prevent water, oil, gasoline and chemical leaks
- 100% effective over a wide temperature range - 76° to 482°F. Tack-free in 90 minutes; fully cured and bonded within 24 hours; attains optimum strength in three days
- Recommended for: motorcycle, personal watercraft, ATV engines



DESCRIPTION	QTY/CS	PART #	MFG #	
3.5 oz	6	TB1211	1211AT100	25.95 G

CLEAR SILICONE SEALANT

- A low odor, fast setting, non slumping paste that cures at room temperature to a rubbery solid
- This multi-purpose RTV silicone sealant can be used in numerous bonding and sealing applications such as: pumps, gearboxes, marine cabins, windows and electrical boxes



DESCRIPTION	QTY/CS	PART #	MFG #	
3 oz	12	TB1212	1212C85G	15.95 G

SEAL 'N' AIR FOR TUBE/TUBELESS TIRES

- ThreeBond's temporary flat tire repair require no tools
- For best results, remove foreign object before inflating
- Aerosol can inflates tire to moderate pressure in only 20 seconds
- Upon resuming riding, white foaming fluid spreads evenly inside tire, sealing the leak
- Tire pressure increases gradually while riding
- Not effective for large holes or sidewall punctures
- Works at temperatures 239° F and above
- For temperatures below 23° F, container may be warmed with hands (not flame) before using



DESCRIPTION	QTY/CS	PART #	MFG #	
Seal 'N' Air	12	TB6000	60T004A6Z	13.95 G



PLASTIC REPAIR KIT REPAIRS: PLASTIC, FUEL TANKS, HOLDING TANKS, WATER TANKS, ETC.



- Simple, effective way to repair cracked or broken plastic
- **Kit** includes: full instructions, glue, primer, accelerator, sandpaper, fibercloth (30" x 1.5"), enough material to repair four to five 6" breaks
- Not recommended for fiberglass
- **Mini kit** contains: enough material to repair approximately two 6" breaks

DESCRIPTION	QTY/CS	PART #	MFG #	
Kit	6	TB1743	1743APLRKT	46.95 G
Mini Kit	12	TB1745	17MPRK	37.95 G

THREEBOND

- tires & wheels
- axles, hubs & springs
- tongue accessories
- hitches
- electrical
- brake parts
- trailer hardware
- locks & pins
- towing & loading
- tie downs
- tools
- chemicals

GROUND ONLY

HI STRENGTH RETAINING

ThreeBond's High strength retaining properties for various threads, screws, bolts, piping joints, gears, pulleys and fans which are not frequently removed or must remain secure for safety and/or structural integrity reasons



DESCRIPTION	QTY/CS	PART #	MFG #		
10 ml	6	TB1303	1303AT000	10.95	G
50 ml	12	TB2303	1303A50C	21.95	G

LOW STRENGTH/ FREQUENT REPAIR

ThreeBond's Low Strength Frequent Repair product is perfect for small screws and bolts which are frequently removed and require a force of only 10-20% greater than that used for tightening

DESCRIPTION	QTY/CS	PART #	MFG #		
10 ml	6	TB1342	1342AT002	10.95	G
50 ml	12	TB2342	1342A50C	21.95	G



GROUND ONLY

BEARING AND STUD LOCK

ThreeBond's Bearing & Stud Lock includes high strength retaining properties for bearings and studs which are not frequently removed and must remain secure for safety or structural integrity reasons



DESCRIPTION	QTY/CS	PART #	MFG #		
10 ml	6	TB1333	1333BT001	10.95	G
50 ml	12	TB2333	1333B50C	21.95	G

HI TEMPERATURE

ThreeBond's Hi Temperature Thread Lock is a new sealing and locking agent made to withstand extreme temperatures without weakening. Incorporates various strengths of anaerobic locking agents which makes it ideal for sealing engine and exhaust components.

DESCRIPTION	QTY/CS	PART #	MFG #		
10 ml	6	TB1360	1360AT003	10.95	G
50 ml	12	TB2360	1360A50C	21.95	G



TRAILER

- tires & wheels
- axles, hubs & springs
- tongue accessories
- hitches
- electrical
- brake parts
- trailer hardware
- locks & pins
- towing & loading
- tie downs
- tools
- chemicals



EPOXY ADHESIVES

“World’s Finest Cold Weather Compound”
#1 Brand for consumers and professionals on the market today.

J-B WELD ORIGINAL COLD WELD FORMULA STEEL REINFORCED EPOXY

- Great for household repairs, automotive, plumbing, marine, crafts and more
- Its two-part epoxy system that provides strong, lasting repairs to metal and multiple surfaces
- Mixed at a ratio of 1:1, it forms a permanent bond and can be shaped, tapped, filed, sanded and drilled after curing
- At room temperature, J-B Weld sets in 20-25 minutes to a dark grey color
- A full cure is reached in 15-24 hours, and sets to a hard bond overnight
- Has a tensile strength of 3960 PSI
- Can withstand temperatures up to 550° F when fully cured
- Sold each
- Display packaged

DESCRIPTION	PART #	MFG #		
J-B Weld	JB8265	8265-S	6.95	G
J-B Weld Professional Size - 10 oz.	446002	8280	19.60	G



J-B KWIKWELD QUICK-SETTING STEEL REINFORCED EPOXY

- J-B KwikWeld is a quick-setting steel reinforced epoxy
- J-B KwikWeld is a fast setting version of The Original J-B Weld two-part epoxy cold weld system
- Provides strong, lasting repairs to metal and multiple other surface types
- Great for household repairs, automotive, plumbing, marine, crafts and more
- After mixing, it forms a permanent bond and can be shaped, tapped, filed, sanded and drilled after curing
- 1:1 mixing ratio
- Sets in 6 minutes and is fully cured in 4-6 hours
- Cures to a dark grey color
- Rated at a tensile strength of 2424 PSI
- Will withstand temperatures up to 300° F
- Sold each
- Display packaged

DESCRIPTION	PART #	MFG #		
J-B KwikWeld	JB8276	8276	6.95	G
J-B KwikWeld Syringe - 25 mL	446020	50176	7.72	G
J-B KwikWeld Professional Size - 10 oz.	446001	8270	22.95	G



J-B MARINE WELD MARINE EPOXY

- J-B MarineWeld is a specially formulated two-part epoxy cold weld system that provides for strong, lasting repairs for bonding different or similar surfaces, such as aluminum, metal, composites, fiberglass and others
- Great for use on boats, personal watercraft, in/outboard engines, deck and hull accessories
- Sets in 20-25 minutes at room temperature and is fully cured to a dark grey color in 15-24 hours
- Once cured, it can be shaped, tapped, filed, sanded and drilled and will retain its strength above or below the waters' surface
- MarineWeld has a 1:1 mixing ratio
- Tensile strength of 3960 PSI
- Sold each
- Display packaged

DESCRIPTION	PART #	MFG #		
J-B MarineWeld	JB8272	8272	6.95	G
J-B MarineWeld Syringe - 25 mL	446019	50172	9.09	G





EPOXY ADHESIVES

“World’s Finest Cold Weather Compound”
#1 Brand for consumers and professionals on the market today.

J-B WOODWELD QUICK-SETTING WOOD EPOXY

J-B WoodWeld is a fast setting two-part epoxy system formulated for wood bonding and repairs. When fully cured it can be shaped, tapped, filed, sanded and drilled. It provides a lasting permanent bond that is stronger than the wood! J-B WoodWeld has a 1:1 mixing ratio, sets in 6 minutes and cures in 1-3 hours. Rated at a tensile strength of 1800 PSI, J-B WoodWeld cures to a light tan color.

Great For:

- Indoor/Outdoor
- Furniture
- Doors
- Windows
- Trim/Molding
- Decks & More

DESCRIPTION	PART #	MFG #	
J-B WoodWeld Syringe - 25 mL	446018	50151	8.36 G

J-B CLEARWELD QUICK SETTING EPOXY

ClearWeld is a quick setting, multipurpose two part epoxy that provides a strong and lasting bond on most surfaces including tile, most plastics, ceramic, glass, wood and metal. ClearWeld is designed to cure with a clear, transparent bond when used at thicknesses of less than 15 mil. ClearWeld has a 1:1 mixing ratio, sets in 5 minutes and cures in 1 hour. With a tensile strength of 4400 PSI, ClearWeld sets to a hard, permanent bond.

Great For:

- Tile
- Most Plastics
- Ceramic
- Glass
- Wood
- Metal

DESCRIPTION	PART #	MFG #	
J-B ClearWeld Syringe - 25mL	446015	50112	6.42 G

J-B PLASTICWELD QUICK SETTING EPOXY

PlasticWeld is a specially formulated two-part adhesive and epoxy filler system that provides for strong, lasting repairs. PlasticWeld will bond a variety of surfaces, such as metal, composites, fiberglass and others. PlasticWeld sets in 5 minutes at room temperature and is fully cured in 1 hour. Using a 1:1 mixing ratio, PlasticWeld combines to a tensile strength of 3200 PSI and cures to an off-white color.

Great For:

- Most Hard Plastics
- ABS
- Fiberglass
- PVC
- Glass
- Vinyl
- Most Composites

DESCRIPTION	PART #	MFG #	
J-B PlasticWeld Syringe - 25 mL	446016	50132	6.46 G

J-B MINUTEWELD

MinuteWeld is a fast setting, multipurpose two part epoxy that provides a strong and lasting bond on most surfaces including tile, most plastics, ceramic, glass, wood and metal. MinuteWeld is designed to bond instantly and cure with a clear, transparent bond when used at thicknesses of less than 15 mil. MinuteWeld has a 1:1 mixing ratio, sets in 1 minute and will fully cure overnight. With a tensile strength of 3200 PSI, MinuteWeld sets to a hard, permanent bond.

- Stronger than Super glues
- Highest Strength in Class
- Our Clearest Weld
- Features No Waste, No mess cap.

DESCRIPTION	PART #	MFG #	
J-B MinuteWeld Syringe - 25 mL	446014	50101	7.72 G



- tires & wheels
- axles, hubs & springs
- tongue accessories
- hitches
- electrical
- brake parts
- trailer hardware
- locks & pins
- towing & loading
- tie downs
- tools

chemicals

TRAILER

- tires & wheels
- axles, hubs & springs
- tongue accessories
- hitches
- electrical
- brake parts
- trailer hardware
- locks & pins
- towing & loading
- tie downs
- tools
- chemicals



EPOXY PUTTY STICKS

“World’s Finest Cold Weather Compound”
#1 Brand for consumers and professionals on the market today.

J-B WATERWELD WILL SET UNDER WATER!

- WaterWeld will plug or seal leaks and patch holes and cracks in almost anything
- Ideal for repairing plumbing, fuel tanks, tub and shower, drains, pool and spa, boats and potable water tanks; setup occurs even under water
- After curing, it can be drilled, tapped, filed, sanded and painted
- Has a set time of 15-25 minutes and sets hard in one hour
- Cures to an off-white color
- Rated at a tensile strength of 900 PSI
- Will withstand temperatures up to 300° F
- Sold each. Display packaged.



DESCRIPTION	PART #	MFG #	
J-B WaterWeld	JB8277	8277	8.95 G

J-B WELD KWIK WOOD REPAIR AND REBUILD ANYTHING MADE OF WOOD!

- Repair and rebuild anything made of wood such as dry rot, knot holes, window and door frames, screw holes, insect damage, furniture and carvings, gouges and cracks, and PVC trim board
- KwikWood is a hand-mixable epoxy putty, formulated to repair and rebuild wood
- After mixing, it cures to the same density as wood and becomes an integral part of the repair
- For use on exterior or interior applications, it contains no solvents, will not rot, shrink, crack or pull away
- KwikWood has a 15-25 minute work life
- After 60 minutes, it can be machined, drilled, tapped, sanded, filed and painted
- Stronger than wood, KwikWood dries to a light tan color
- Sold each. Display packaged.



DESCRIPTION	PART #	MFG #	
J-B Kwik Wood	JB8257	8257	7.95 G

J-B PLASTICWELD REPAIR AND REBUILD ANYTHING MADE OF ABS, PVC, & CPVC!

- PlasticWeld is a hand-mixable, fast-setting epoxy putty that forms a durable bond to most major plastic types
- After mixing, it forms a polymer compound that can be molded or used to build up and repair just about anything made from plastic
- When cured, it can be sawed, drilled, carved, sanded and painted
- PlasticWeld has a 20-25 minute work life; functional cure occurs in 2-3 hours
- Cures to an off-white color
- Rated at a tensile strength of 350 PSI
- Does not adhere to polyethylene, polypropylene or some other plastics
- Test for adhesion first
- Sold each. Display packaged.



DESCRIPTION	PART #	MFG #	
J-B PlasticWeld	JB8237	8237	8.95 G

TRAILER



SPECIALTY PRODUCTS

“World’s Finest Cold Weather Compound”
#1 Brand for consumers and professionals on the market today.

J-B PLASTICBONDER BODY PANEL ADHESIVE, FILLER & SEALER

Strength 3770 PSI
Set Time 15 Minutes
Sand in 30 Minutes
Dries Tan

Great For:

- Filling Dents
- Bumpers
- Automotive Trim
- Composite Panels
- Interior & Exterior Plastic Parts
- Polypropylene & Polyethylene Plastics
- Fiberglass

Plastic Bonder is a quick-setting, two-part, urethane adhesive system that provides strong and lasting repairs and works on thermoset, carbon fiber composites, thermoplastics, coated metals, concrete & more. Plastic Bonder has a 1:1 mixing ratio, sets in 15 minutes and can be sanded after 30 minutes. With a tensile strength of 3770 PSI, Plastic Bonder sets to a tan color and cures to a hard, permanent bond.



DESCRIPTION	PART #	MFG #	
J-B PlasticBonder Syringe - 25 mL	446017	50133	7.94 G

J-B HIGHHEAT TEMPERATURE RESISTANT EPOXY PUTTY

Strength 800 PSI at Room Temp. 600 PSI at 400°F
Set Time 1 Hour
Functional Cure 8 Hours
Dries Machine Grey

Great For:

- Exhaust Manifolds
- Tail Pipes
- Mufflers
- Engine Blocks
- Duct Work
- Machinery
- High Temperature Projects

HighHeat is a hand mixable epoxy putty stick specifically formulated to bond and repair materials that will be exposed to high temperatures in automotive and industrial maintenance applications. It cures to a tough, hard bond with little to no shrinkage. This industrial-strength product outperforms conventional epoxy putties at high temperatures and sets in 1 hour at room temperature. After 8 hours, it can be drilled, tapped, machined, ground, filed and painted. HighHeat is rated at a tensile strength of 800 PSI and cures to a machine grey in color. It is able to withstand continuous heat exposure of 400°F and intermittent heat exposure to 550°F



DESCRIPTION	PART #	MFG #	
J-B HighHeat Epoxy Stik	446003	8297	8.95 G

J-B PERM-O-SEAL RADIATOR STOP LEAK

Great for:

- Permanent Repairs for All Car, Truck, Van, Bus and Tractor Radiators
- Will Not Clog or Harm Cooling System

J-B Weld Perm-O-Seal is a specially formulated non-toxic compound ground to a very fine particle size to quickly mix and flow into all areas of the cooling system to find and seal leaks. The powdered concentrate allows for an economical repair as compared to liquid based alternatives that use similar technology. The special compound will quickly seal leaks and will also act as a rust inhibitor and lubricant to internal cooling system parts. It will not clog or harm your cooling system.



DESCRIPTION	PART #	MFG #	
J-B Perm-O-Seal (Carded)	446004	DS-114	2.54 G

- tires & wheels
- axles, hubs & springs
- tongue accessories
- hitches
- electrical
- brake parts
- trailer hardware
- locks & pins
- towing & loading
- tie downs
- tools
- chemicals

TRAILER

- tires & wheels
- axles, hubs & springs
- tongue accessories
- hitches
- electrical
- brake parts
- trailer hardware
- locks & pins
- towing & loading
- tie downs
- tools
- chemicals

TRAILER



SILICONE SEALANTS

“World’s Finest Cold Weather Compound”
#1 Brand for consumers and professionals on the market today.

J-B WELD CLEAR SILICONE

- J-B Weld Clear Silicone
- Sealant & Adhesive
- RTV all purpose technology
- Set time 1 hour
- Fully cured 24 hours
- Waterproof
- All purpose (auto, household)

DESCRIPTION	PART #	MFG #	
J-B Clear RTV Acetoxo - 3 oz.	446005	31310	5.95 G



J-B WELD BLACK SILICONE

- J-B Weld Black Silicone
- RTV all purpose technology
- Set time 1 hour
- Fully cured 24 hours
- Mold and Mildew Resistant
- Auto and Household
- Bonding and Sealing
- Weather Stripping, Moldings

DESCRIPTION	PART #	MFG #	
J-B Black RTV Acetoxo - 3 oz.	446009	31319	4.95 G



J-B WELD BLUE SILICONE

- J-B Weld Blue Silicone
- RTV all purpose technology
- Set time 1 hour
- Sensor Safe
- Gasket Maker and Sealant
- Auto and Household
- Timing Gear Covers
- Transmission & Oil Pans

DESCRIPTION	PART #	MFG #	
J-B Blue RTV Acetoxo - 3 oz.	446008	31316	5.95 G



J-B WELD WHITE SILICONE

- J-B Weld White Silicone
- RTV 100% Silicone
- Waterproof Sealant & Adhesive
- Set time 1 hour
- Mold and Mildew Resistant
- Tub & Shower
- Sinks & Bathroom Fixtures
- Windows, Interior Trim, Door Frames
- Moldings and Lens Housing

DESCRIPTION	PART #	MFG #	
J-B White RTV Acetoxo - 3 oz.	446006	31312	5.95 G





SILICONE SEALANTS

“World’s Finest Cold Weather Compound”
#1 Brand for consumers and professionals on the market today.

J-B WELD ULTIMATE GREY SILICONE

- J-B Weld Ultimate Grey Silicone
- Oxime RTV 100% Silicone
- Gasket Maker and Sealant
- High Torque Load Applications
- Import Cars (Honda, Toyota, Nissan etc.)
- Maximum Oil Resistance
- Set time 1 hour
- Temperature Resistant up to 500° F
- Intake Manifolds
- Low Odor, Non Corrosive and Sensor Safe
- Oil Pans and Timing Gear Covers
- Transmission Pans and Cam Covers

DESCRIPTION	PART #	MFG #	
J-B Ultimate Grey Oxime - 3 oz.	446012	32327	7.95 G
J-B Grey Water, Pump, & Thermostat Oxime - 5 oz.	446010	32507	3.95 G



J-B WELD ULTIMATE BLACK SILICONE

- J-B Weld Ultimate Black Silicone
- Oxime RTV 100% Silicone
- Maximum Oil Resistance
- Set time 1 hour
- Temperature Resistant up to 500° F
- Low Odor and Sensor Safe
- Oil Pans and Valve Covers
- Transmission Pans
- Timing Gear Covers

DESCRIPTION	PART #	MFG #	
J-B Ultimate Black Oxime - 3 oz.	446013	32329	6.64 G
J-B Maxi Black Oxime - 5 oz.	446011	32509	3.66 G



J-B WELD HI TEMP RED SILICONE

- J-B Weld Hi Temp Red Silicone
- RTV all purpose technology
- Set time 1 hour
- Temp. Resistant up to 650° F
- Gasket Maker and Sealant
- Oil Pans and Valve Covers
- Exhaust Manifolds and Water Pumps
- Timing and Differential Covers

DESCRIPTION	PART #	MFG #	
J-B High Temp. Red Acetox - 3 oz.	446007	31314	6.95 G



- tires & wheels
- axles, hubs & springs
- tongue accessories
- hitches
- electrical
- brake parts
- trailer hardware
- locks & pins
- towing & loading
- tie downs
- tools
- chemicals

TRAILER

tires & wheels
axles, hubs & springs
tongue accessories
hitches
electrical
brake parts
trailer hardware
locks & pins
towing & loading
tie downs
tools
chemicals



THREADLOCKERS

J-B Weld threadlockers are superior to conventional mechanical devices because they secure the entire fastener assembly against loosening from shock and vibration so fastener clamping forces are maintained. Threadlockers seal the threads against leakage and prevent rust and corrosion.

“World’s Finest Cold Weather Compound”
#1 Brand for consumers and professionals on the market today.

J-B WELD PERMA-LOCK MEDIUM STRENGTH THREADLOCKER

- 1/4" to 1" fasteners that have a slight oil film.
- Prevents vibration loosening.
- Temperature resistant to 300°F.
- Features a no spill, drip or clog cap.
- OEM approved.
- Suggested applications: rocker arms, stud bolts, fasteners & bushings, loose screws, vibration sensitive items.

DESCRIPTION	PART #	MFG #		
6 mL	JB24206	24206	6.95	G
13 mL	JB24213	24213	14.95	G
36 mL	446025	24236	22.95	G
50 mL	446026	24250	34.95	G



J-B WELD PERMA-LOCK HIGH STRENGTH THREADLOCKER

- For heavy-duty applications. Temperature resistant to 300°F.
- Especially well suited for permanently locking studs.
- Locks against vibration loosening.
- Requires extra effort or special tools for removal.
- Features a no spill, drip or clog cap.
- OEM approved.
- Suggested applications: rocker arms, stud bolts, fasteners & bushings, loose screws, vibration sensitive items.

DESCRIPTION	PART #	MFG #		
6 mL	446021	27106	6.95	G
13 mL	446022	27113	14.95	G
36 mL	446023	27136	22.95	G
50 mL	446024	27150	34.95	G



J-B WELD PERMA-LOCK LOW VISCOSITY THREADLOCKER

- Low viscosity, penetrating grade threadlocker
- For use on fasteners, screws, electrical connectors and pre-assembled parts
- Temperature resistant to 300 degree Fahrenheit
- Penetrates between part surfaces, so no disassembly is required
- OEM approved

DESCRIPTION	PART #	MFG #		
6 mL	446027	29006	6.95	G



TRAILER



LUBRIMATIC



- tires & wheels
- axles, hubs & springs
- tongue accessories
- hitches
- electrical
- brake parts
- trailer hardware
- locks & pins
- towing & loading
- tie downs
- tools

12" FLEXIBLE HOSE

This grease gun hose features steel 1/8" NPT male fittings on each end. Good for up to 3,000 PSI recommended working pressure. 12,000 PSI burst pressure. This hose is intended for use on hand-operated grease guns. Flexible whip.

DESCRIPTION	PART #	MFG #	
12" Flexible Hose	LB11825	10-212	7.50 G



WHITE LITHIUM GREASE

- LubriMatic Motor Assembly Grease is a quality white grease (NLGI#1) specifically designed to protect engine parts
- The exceptional consistency of this grease creates ease in application for all engine parts including valves, bearings, crankshafts, wheels and nut assemblies and all other areas where metal-to-metal contacts occur

DESCRIPTION	QTY/CS	PART #	MFG #	
10 oz Tube	12	LB11395	11395	7.80 G



ELECTRICAL CONTACT GREASE

- Protects electrical connections from corrosion
- Water resistant formulation sheds moisture and doesn't wash away
- NGLI #2, drop point 550° F.

DESCRIPTION	QTY/CS	PART #	MFG #	
2 oz Tube	12	LB11755	11755	8.90 G



FLUID QUART PUMP

- Fits standard quart bottles
- Ideal for adding fluids to small engines
- Flexible hose gets hard to reach fill plugs
- Packaged

DESCRIPTION	PART #	MFG #	
Pump, Sold Each, Packaged	LB11244	55-001	7.15 G

HEAVY DUTY, LITHIUM BASE GREASE

Long lasting formula delivers high performance for a wide range of heavy-duty applications.

DESCRIPTION	PART #	MFG #	
Package of 4	1728	11300	14.80 G



TRAILER

chemicals



- tires & wheels
- axles, hubs & springs
- tongue accessories
- hitches
- electrical
- brake parts
- trailer hardware
- locks & pins
- towing & loading
- tie downs
- tools
- chemicals



MARINE CORROSION CONTROL & TRAILER BEARING GREASE

- A sophisticated lubricant for use in severe operating conditions caused by salt water and salt air
- Water resistant, rust and corrosion preventative
- Recommended for all corrosion marine applications as well as boat trailers, wheel bearings including disc brake bearings



DESCRIPTION	QTY/CS	PART #	MFG #	
1 lb Resealable Tub	12	LB11404	11404	11.60 G
14 oz Cartridge	10	LB11402	11402	9.40 G

WHITE LITHIUM GREASE

- Includes zinc additives for a clean, white color
- Ideal for general home, shop, marine, snowmobile and industrial applications
- Provides superior performance and protection in most weather and temperature conditions

DESCRIPTION	QTY/CS	PART #	MFG #	
1 lb Resealable Tub	12	LB11350	11350	8.40 G
14 oz Cartridge	10	LB11354	11354	8.40 G

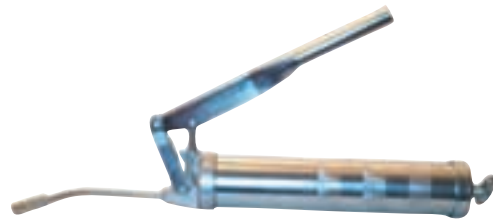

LEVER ACTION GREASE GUN

- Three way loading
- Heavy duty performance
- Display carton packaging
- Uses 14 oz cartridge
- Zinc plated for maximum rust and corrosion resistance

DESCRIPTION	PART #	MFG #	
Lever Action Grease Gun	LB11155	30-465	28.95 G

LOW-TEMP MULTI PURPOSE LITHIUM GREASE

- Powerful, professional-grade UltraLube instantly penetrates creating long-lasting bonds to metal and even plastic parts.
- Biodegradable
- Base oil is derived from vegetables - a renewable resource
- Contain no zinc or chlorine
- No harsh odors
- Neutral in water
- Safer for you, your family and the environment
- 14 oz (397 grams) cartridge. 10 per case-cut carton

DESCRIPTION	PART #	MFG #	
14 oz Cartridge	LB10373	10373	8.95 G



MIDGET GREASE GUN KIT

- The ideal tool for the do-it-yourselfer
- Includes one midget gun and one 3 oz cartridge of multi-purpose grease
- 2-way loading coupler has ball check to prevent leakage

DESCRIPTION	PART #	MFG #	
Midget Grease Gun Kit	1727	30-192	22.15 G



PERMATEX

ELIMINATOR II® ENGINE DEGREASER

Quickly dissolves and removes grease, oil and dirt from all types of equipment. Cleans iron, steel, aluminum, magnesium and copper. Not harmful to metal, rubber, plastic, or concrete. Rinses off easily with water. Suggested applications: engines, garage floors, tools, machinery. Sold each.

DESCRIPTION	QTY/CS	PART #	MFG #	
15 oz Aerosol Can	12	AG80043	80043	6.95 G



tires & wheels

axles, hubs & springs

tongue accessories

hitches

electrical

brake parts

trailer hardware

locks & pins

towing & loading

tie downs

tools

chemicals



CHAIN LUBE

Cleans, lubricates, extends life and protects all types of roller chains, gears and cables that operate under exposed conditions. Easy-to-apply foaming action assures effective application. Repels dirt, sand, dust. Minimal "throw - off". Contains no ODC's. Suggested Applications: Ideal for any chain-driven tool or vehicle such as motorcycles, mopeds, chainsaws, lawnmowers and bicycles. Sold each.

DESCRIPTION	QTY/CS	PART #	MFG #	
5 oz Aerosol Can	12	AG80075	80075	4.95 G



BATTERY CLEANER

Spray it on and wash corrosion off. Works in just three minutes. Suggested applications: automotive, marine, farm machinery and motorcycle batteries. Sold each.

DESCRIPTION	QTY/CS	PART #	MFG #	
5.75 oz Aerosol Can	12	AG80369	80369	4.95 G



WHITE LITHIUM GREASE

All-purpose white lubricant for metal-to-metal and metal-to-plastic applications. Protects against rust and makes surfaces friction-free. Stainless and nontoxic. Contains no ODCs. Withstands moisture and high heat. Suggested applications: door hinges, hood latches, trunk latches, hatchback struts, seat tracks, garage door and delivery truck door tracks. Sold each.

DESCRIPTION	QTY/CS	PART #	MFG #	
10.75 oz Aerosol Can	12	AG81981	81981	7.95 G



PRO-STRENGTH BRAKE & PARTS CLEANER

Aggressively penetrates, dissolves, and removes oil, grease, and brake fluid. Dries fast with no residue. Developed for brake professionals. Contains no ODCs. Suggested applications: all brake systems, C.V. joints, machinery, tools, farm equipment. Sold each.

DESCRIPTION	QTY/CS	PART #	MFG #	
19 oz Aerosol Can	12	AG82606	82606	5.95 G



TRAILER

- tires & wheels
- axles, hubs & springs
- tongue accessories
- hitches
- electrical
- brake parts
- trailer hardware
- locks & pins
- towing & loading
- tie downs
- tools
- chemicals



PERMATEX HAND CLEANERS



PERMATEX FAST ORANGE PUMICE AND SMOOTH LOTION HAND CLEANER

The #1 selling, biodegradable, waterless, petroleum solvent-free hand cleaner that contains no harsh chemicals, petroleum solvents or ammonia that can sting cuts or abrasions. Pure, fresh-smelling natural citrus power does the cleaning. Fortified with aloe, lanolin, glycerin, and other skin conditioners to soothe raw, rough hands. Fine Pumice deep cleans the toughest dirt. Works great on laundry stains (smooth lotion only), scuff marks, tile floors, pet odors and many other household cleaning needs. * Readily Biodegradable according to OECD Method 301E . Sold each.



PUMICE LOTION

DESCRIPTION	QTY/CS	PART #	MFG #	
7.5 Fluid oz Bottle	12	AG25108	25108	3.95 G
1 Gallon Bottle w/Pump	4	AG25218	25219	22.95 G

SMOOTH LOTION

DESCRIPTION	QTY/CS	PART #	MFG #	
7.5 Fluid oz Bottle	12	AG23108	23108	3.95 G
1 Gallon Bottle w/Pump	4	AG23218	23218	23.95 G

PERMATEX FAST ORANGE PUMICE BAR HAND SOAP



Fast Orange® Pumice Bar Hand Soap is a new way to clean everyday soils from hands. The large, 5.75 oz soap bar contains fine pumice for thorough cleaning and leaves hands feeling soft. Ideally suited for the cleaning needs of automotive technicians. Suggested Applications: Removes, oil, grease, grime, paint and other everyday soils. Sold each.

DESCRIPTION	PART #	MFG #	
5.75 oz Bar	AG25575	25575	3.95 B

PERMATEX DISPOSABLE NITRILE GLOVES



Permatex Nitrile Disposable Gloves are made from a 100% synthetic rubber that provides superior resistance to a wide range of solvents and hazardous chemicals. Suitable for users with natural rubber latex sensitivity. They are fully textured to provide a secure grip on dirty parts and tools. Gloves are lightly powdered, which makes them easier to put on and take off. When superior chemical resistance is required, Nitrile Disposable Gloves provide users with ideal heavy-duty hand protection.

DESCRIPTION	PART #	MFG #	
Large, 100 Count Box	AG09185	09185	21.95 G
X-Large, 100 Count Box	AG09186	09186	21.95 G



PERMATEX

PERMATEX MEDIUM STRENGTH THREADLOCKER BLUE GEL (GEL TWIST APPLICATOR)

OEM specified. Gel formula provides "liquid-reliability" without drips, globs, mess or waste. The GEL TWIST™ pin-point applicator puts the Threadlocker right where you want it...on the part! All-purpose, medium strength threadlocker. Ideal for all nut and bolt applications 1/4" to 3/4" (6mm to 20mm). Eliminates need for stocking expensive lock nuts and lock washers. Locks and seals while preventing parts loosening due to vibration. Protects threads from corrosion. Removable with hand tools for easy disassembly. Conforms to ASTM D 5363 AN0321 (Mil-S-46163A, Type II, Grade N).

DESCRIPTION	PART #	MFG #	
10g Gel Twist Applicator, Carded	AG24010	24010	17.95 G

PERMATEX HIGH STRENGTH THREADLOCKER RED GEL (GEL TWIST APPLICATOR)

OEM specified. Gel formula provides "liquid-reliability" without drips, globs, mess or waste. The GEL TWIST™ pin-point applicator puts the Threadlocker right where you want it...on the part! High strength threadlocker for heavy-duty applications 3/8 inch to 1 inch (10mm to 25mm). Especially well-suited for permanently locking studs and press fits. Adds 3,000 PSI holding power on slip and press fit assemblies. Replaces set screws and snap rings. Locks against vibration loosening. May require heat or special tools for removal. Conforms to ASTM D5363 AN0221 (Mil-S-46163A, Type I, Grade K).

DESCRIPTION	PART #	MFG #	
10g Gel Twist Applicator, Carded	AG27010	27010	17.95 G



THE GEL TWIST ADVANTAGE

GEL Twist Threadlocker will not drip or run like traditional liquid threadlockers and is easily portable. Threadlocker Gel stays on the part which reduces waste and makes it great for use in vertical applications.

The extended nozzle allows for easy application on "hard to reach" locations.

tires & wheels

axles, hubs & springs

tongue accessories

hitches

electrical

brake parts

trailer hardware

locks & pins

towing & loading

tie downs

tools

chemicals

TRAILER

PERMATEX ULTRA-BLACK GASKET MAKER SEALS EXHAUST JOINTS

OEM specified. For dealership warranty requirements, Ultra Black® ensures extended drivetrain warranty compliance. Fast-curing formula. Sensor-safe, low odor, noncorrosive. Meets performance specs of OE silicone gaskets. Retains high flexibility, oil resistant properties through use of a patented adhesion system. Temperature range -65° F to 500° F (-54° C to 260° C) intermittent; resists auto and shop fluids and vibration.

DESCRIPTION	PART #	MFG #	
3.35 oz Tube, Carded	AG82180	82180	7.95 G

PERMATEX ULTRA-BLUE RTV SILICONE GASKET MAKER

OEM specified. Designed specially for high-torque and high vibration applications, like those common in import engines, this premium RTV gasket maker exceeds manufacturers' performance requirements. Sensorsafe, low odor, and noncorrosive. Maximum vibration resistance, with outstanding resistance to oils, cooling and shop fluids. Guaranteed not to leak. Temperature range -65° F to 500° F (-54° C to 260° C) intermittent.

DESCRIPTION	PART #	MFG #	
3.35 oz Tube, Carded	AG81724	81724	7.95 G

PERMATEX ANTI-SEIZE LUBRICANT

A highly refined blend of aluminum, copper and graphite lubricants. Use during assembly to prevent galling, corrosion and seizing due to weathering or chemicals. Anti-Seize assures easier disassembly. Temperature range: -60° F to 1600° F (-51° C to 871° C). Salt, corrosion and moisture resistant – ideal for marine use.

DESCRIPTION	PART #	MFG #	
1 oz Tube, Carded	AG81343	81343	4.95 G
4 oz Brush Top Bottle	AG80071	80071	7.95 G

PERMATEX NON-CHLORINATED BRAKE & PARTS CLEANER

Penetrates, dissolves and removes dirt and oil from brake systems and metal parts. Safer for aluminum. Leaves no contaminant-attracting residue or chlorinated solvent run-off. Helps manage EPA halide limits. *NFPA Fire Code 30B.

DESCRIPTION	PART #	MFG #	
20 oz Aerosol Can	AG82220	82220	5.95 G





MAXIMA

CONTACT CLEANER

Heavy duty citrus scented aerosol cleaner is a blend of special cleaning agents that remove grease, oil and other contaminants. Extra heavy propellant charge provides maximum spray pressure for hard to reach areas. Outstanding for use on all engine and suspension parts, carburetors, brakes, spark plugs and much more. Sold per can.



DESCRIPTION	QTY/CS	PART #		
13 oz Aerosol Can	12	930051	6.95	G



MPPL PENETRANT LUBE

Superior, all-purpose spray-on penetrating lubricant displaces moisture while providing excellent rust and corrosion protection. MPPL forms a protective film on metal and will not harm plastic or painted surfaces. Sold per can.

DESCRIPTION	QTY/CS	PART #		
20 oz Aerosol Can	12	930054	8.95	G



WATERPROOF GREASE

Multi-purpose grease has excellent resistance to water wash-out and it clings to metal surfaces under the most severe conditions. For use on motorcycle, ATV, personal watercraft and snowmobile components. Provides excellent protection against high loads, extreme temperatures, moisture, rust and corrosion. Sold per jar.



DESCRIPTION	QTY/CS	PART #		
16 oz Jar	12	930057	8.95	G

PUMP ONLY



5-GALLON PAIL PUMP

The economical plastic pump fits on all Maxima 5-gallon pails and 55-gallon drums.

DESCRIPTION	QTY/CS	PART #		
Plastic Pump	N/A	930069	37.95	G

- tires & wheels
- axles, hubs & springs
- tongue accessories
- hitches
- electrical
- brake parts
- trailer hardware
- locks & pins
- towing & loading
- tie downs
- tools
- chemicals

TRAILER

IPONE



IPONE DEGREASER SPRAY

- Ideal for cleaning your motorcycle without having to resort to high pressure washing
- Excellent results on all types of greasy deposits; fork seal seepage, chain lube overspray on rim and swing arm, oil deposits on exhaust and rear fender, air filter box, etc.

DESCRIPTION	QTY/CS	PART #	MFG #		
400 ML	24	46-722	422-D	9.95	A
750 ML	12	46-720	720	11.95	A



IPONE BRAKE CLEANER SPRAY

- Specially formulated to degrease friction parts such as disc brakes, brake pads, clutch plates, disc drums and brake shoes
- Also can be used to clean sticky parts

DESCRIPTION	QTY/CS	PART #	MFG #		
750 ML	12	46-750	750	13.95	A



IPONE GREASE R HIGH-TECH GREASE SPRAY

- High tech aluminum based grease for rust and friction protection
- Recommended for off-road motorcycle chains
- Resistant to pressure, water and salted atmosphere
- Heat resistant up to 800° C.
- Recommended for parts and axles under high pressure
- Ideal for bearing, axle and chain

DESCRIPTION	QTY/CS	PART #	MFG #		
500 ML	12	46-558	558	12.95	A



IPONE RENOVATOR PLASTIC AND RUBBER PROTECTANT

- Protects and rejuvenates plastic & rubber components on your bike
- Leaves a protective film, which resists fading and cracking due to ultra-violet rays, salt and humidity
- Anti-static film does not attract dust and protects against friction
- Applying spray after washing the Renovator will bring back your ATVs original shine and luster

DESCRIPTION	QTY/CS	PART #	MFG #		
750 ML	12	46-740	740	15.95	A



IPONE PROTECTOR 3 MULTI-PURPOSE LUBRICANT

- 3 in 1 product: insulates, prevents rust and leaves a waterproof seal which helps clean your bike
- Protects electrical wires and smoothes cables and threads

DESCRIPTION	QTY/CS	PART #	MFG #		
400 ML	24	46-732	732-D	10.95	A
750 ML	12	46-730	430	13.95	A



tires & wheels

axles, hubs & springs

tongue accessories

hitches

electrical

brake parts

trailer hardware

locks & pins

towing & loading

tie downs

tools

chemicals

TRAILER

- tires & wheels
- axles, hubs & springs
- tongue accessories
- hitches
- electrical
- brake parts
- trailer hardware
- locks & pins
- towing & loading
- tie downs
- tools
- chemicals



PJ1 CHEMICALS CLEANERS & PROTECTANTS

PJ1 SUPER CLEANER

Multi-Application Non-Residue Degreaser

Attributes:

- High pressure blasts
- Powerful solvents melts grease and grime away
- Dries quickly
- Leaves no residue

DESCRIPTION	QTY/CS	PART #	MFG #		
13 oz	6	909041	3-21	11.29	L



PJ1 SPRAY & WASH

Aggressive Degreaser and Cleaner

Attributes:

- Rinses off with water
- Save on plastics
- Leaves no film or residue
- Has pleasant fragrance

DESCRIPTION	QTY/CS	PART #	MFG #		
13 oz	6	909043	15-20-1	10.13	L



PJ1 LPC-3[®] PENETRANT/LUBRICANT

Super Rust Busting Penetrating Lubricant

Attributes:

- Aggressively penetrates to increase efficacy
- Multipurpose lubricant
- Super rust buster
- Protects metal

DESCRIPTION	QTY/CS	PART #	MFG #		
11 oz	6	909058	12-11	13.49	L



PJ1 PROFESSIONAL BRAKE CLEANER

Professional Power Brake Cleaner

Attributes:

- Powerful spray
- Cleans and degreases contaminants from brake units
- Evaporates quickly and leaves no residue
- Improves braking performance

DESCRIPTION	QTY/CS	PART #	MFG #		
13 oz	6	909046	40-2-1	11.29	L

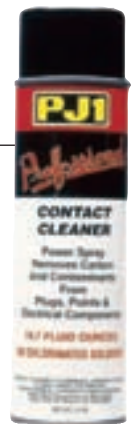

PJ1 PROFESSIONAL CONTACT CLEANER

Professional Contact Cleaner

Attributes:

- Powerful Spray
- Removes Carbon and contaminants from plugs, points, and electrical components

DESCRIPTION	QTY/CS	PART #	MFG #		
13 oz	6	909048	40-3-1	11.29	L



PJ1 RENEW AND PROTECT[®]

Non Oily Surface Treatment

Attributes:

- Unique, super silicone formula provides a penetrating moisturizer
- Restores original appearance
- Leaves satin not glossy finish
- For rubber, vinyl, plastic, wood and treated leather.

DESCRIPTION	QTY/CS	PART #	MFG #		
8 Fluid oz	12	909049	23-8	14.83	L
16 Fluid oz	12	909050	23-16	20.09	L



PERFORMANCE TOOL

PRO GREASE GUN

- Professional quality heavy duty construction and chrome plated finish for long service life
- Short stroke "lever action" for easy use in tight spaces
- Vented zinc die cast head cap
- Positive lock for easy filling
- Air bleeder valve eliminates air lock
- Knurled thick wall barrel for secure grip
- Comfort grip lever handle
- Uses standard 14 oz grease cartridge



DESCRIPTION	PART #	MFG #		
Grease Gun	W54202	W54202	17.95	G

PRO PISTOL GRIP GREASE GUN

- Professional quality heavy duty construction and chrome plated finish for long service life
- Pistol grip action for easy use
- Vented zinc die cast head cap
- Positive lock for easy filling
- Air bleeder valve eliminates air lock
- 2 way filling: standard 14 oz grease cartridge or bulk
- Comfort grip lever handle



DESCRIPTION	PART #	MFG #		
Grease Gun	260066	W54204	18.95	G

MINI GREASE GUN WITH GREASE

- Heavy duty construction
- "Pistol Grip" action for easy use in tight spaces
- Vented zinc die cast head cap
- Positive lock for easy filling
- Air bleeder valve eliminates air lock
- Uses 3 oz grease cartridge (included)
- Replacement grease cartridge part # 260068



DESCRIPTION	PART #	MFG #		
Mini Grease Gun	260067	W54205	14.95	G

2-PACK 3 OZ MULTI PURPOSE GREASE

- Multi purpose lithium based grease is designed for light duty applications which require extended lubrication
- For light duty automotive, industrial, agricultural or commercial equipment
- Smooth consistency, water resistant and extremely stable
- Use on springs, water pumps, bearings, chassis fittings and any general lubrication projects



DESCRIPTION	PART #	MFG #		
2-Pack 3 oz Multi Purpose	260068	W54206	5.95	G

tires & wheels

axles, hubs & springs

tongue accessories

hitches

electrical

brake parts

trailer hardware

locks & pins

towing & loading

tie downs

tools

chemicals

TRAILER

- tires & wheels
- axles, hubs & springs
- tongue accessories
- hitches
- electrical
- brake parts
- trailer hardware
- locks & pins
- towing & loading
- tie downs
- tools
- chemicals

IMPORTANT NOTICE After installing Ride-On TPS Motorcycle Formula sealant into your tires you may notice a slight vibration until the sealant has warmed up and distributed evenly in your tires. This process usually takes 2 to 5 miles. Please DO NOT attempt to rebalance tires after the installation of Ride-On TPS Motorcycle Formula. Ride-On TPS is a balancing compound. Ride-On TPS will act as a balancer and will result in erroneous readings from a dynamic spin balancer that does not compensate for tire deflection, weight of the bike, brakes, or other suspension components. Ride-On is TPMS friendly, however it is not recommended for use in 2009, 2010, and 2012 Honda Gold Wings as their TPMS Sensors are not hermetically sealed.



RIDE-ON TPS TIRE BALANCER AND SEALANT



DESCRIPTION	PART #		
MOTORCYCLE FORMULA			
8 oz. (12 per case)	650274	14.95	L
5 Gallon Pail	650272	606.95	G
Pump For 5 Gallon Pail	650273	174.95	AE
ATV/UTV FORMULA			
32 oz. (12 per case)	650275	17.95	G
5 Gallon Pail	650276	305.95	G

BALANCE With one installation of Ride-On, lead weights become a thing of the past. While Ride-On works in conjunction with traditional weights, you won't need them anymore. Ride-On is specially formulated to hydrodynamically balance high-speed tires and dampen road noise and vibrations that cause a rough ride. The great thing is Ride-On will continue to adjust and literally rebalance your tires as you ride for the legal life of the tires. So go ahead, pop off those wheel weights, shine your wheels, and enjoy the smoothest ride you have ever experienced on your bike.

SAFETY FIRST With Ride-On TPS tire sealant, your tire literally fixes itself! If your tire is punctured, the centrifugal force of the rotating tire and the internal air pressure force Ride-On into the hole, sealing it virtually instantly. Since it helps eliminate porosity leaks that cause tires to deflate over time, your tires stay properly inflated, last longer, your bike handles better and gets more miles per gallon.

WORKS IN TUBE AND TUBELESS TIRES Ride-On TPS eliminates 85-95% of flats in tubeless tires from objects up to 1/4" (1/8" for tube tires) that penetrate the contact patch of the tire. Since puncturing objects often tear tubes, Ride-On's efficiency in tube tires is reduced to 55-65%. If the puncturing object remains in the tire, it is vital to remove it as soon as possible to prevent further injury to the tire or tube. Our company takes the position that any repair in a motorcycle tire should be treated as temporary.



RIDE-ON LED SMART CAPS

DESCRIPTION	PART #		
LED SMART CAPS			
LED Smart Cap (2 Pack)	650277	34.95	B
LED Smart Cap Small Display w/Wired Cap	650278	23.95	B

The LED Smart Cap Tire Pressure Monitor (TPMS) valve cap is a must for people that want to make sure that their tires are properly inflated. Once installed the LED Smart Cap TPMS valve cap will alert you if the tire pressure drops by a setpoint pressure. The Light Vehicle version of the Smart Cap Tire Pressure Monitor system is available for automobiles, SUVs, light trucks, vans, motorcycles, scooters, trailers, ATVs, etc. with a pressure range of 10 to 70 psi and a low pressure warning trigger of 4 psi (with a +/- 10% accuracy).

- Easy to Install - Simply screw valve caps onto tire valve stems.
- Bright blinking LED light that is visible in daylight and night time
- Self-Calibrating - Automatically calibrates to pressure the tire was set at when the cap was installed. The same valve can be used with tires from 10 psi to 70 psi (Auto and Motorcycle Version with a 4 psi pressure drop alarm) or 30 to 170 psi for commercial version (available in 4 psi or 8 psi pressure drop alarm)
- Automatically compensates for ambient temperature changes to avoid false alarms.
- Comes with integrated anti-theft device.
- Long lasting low pressure alert - blinking red light alerts of low pressure for 750 hours (more than a month).
- Low battery alarm - the led valve cap will blink yellow for up to 100 hours to alert you that the batteries are running low.
- Long Lasting 3 year battery shelf life.
- Great compliment to Ride-On TPS filled tires - 100% compatible and now you can be alerted of a slow leak.
- Proper tire inflation pressure helps extend tire life.
- Proper tire inflation pressure helps optimize fuel economy and save up to 3% in fuel.
- Available in 2 and 4 pack blister Packaging, as well individual and bulk packaging.





HARDLINE PRODUCTS

RX UV PROTECTANT CLEANER AND POLISH

Rx UV Protectant Cleaner & Polish™ was specifically made for the Power Sports Industry and is quickly becoming the standard for protecting plastic and metal surfaces found on boats, motorcycles, PWC, ATV's, UTV's and all the accessories that go with them. Seals the surface with a micro-thin layer of UV protectant. Restores nutrients that sun, water and dirt take away. Just one use moisturizes and restores shine quickly and easily. Cleans and protects any plastic and metal. Just spray and wipe clean.

- Boaters use Rx on your Isinglass®, Strata Glass®, plastic, stainless steel, aluminum, gel-coat or any painted surface
- Vinyl windows will stay cleaner longer from water spots, salt spray and resist damaging UV rays from the sun
- Provides 100% UVA and UVB protection
- Cleans and protects from dirt, water spots, salt spray and grime
- Use on gauges, instruments, windscreens, bezels & trim to protect from the sun and add shine to your surfaces
- Its anti-static formula reduces salt and dirt buildup

DESCRIPTION	PART #	MFG #		
14 oz RX	315003	PLEX-RX	9.95	G



- tires & wheels
- axles, hubs & springs
- tongue accessories
- hitches
- electrical
- brake parts
- trailer hardware
- locks & pins
- towing & loading
- tie downs
- tools
- chemicals

STICKER-ON!



Sticker On!™ takes the frustration away from decal applying. No more bubbled, misaligned, or wrinkled decals. Curvy application areas are easier to do. Works on any decal application, registration numbers, graphic kits, sponsorship decals, number plate backgrounds, racing numbers, OEM decals and much more. Simply spray it on the back of your decal and the application area, slide and position into place. Sticker-On!™ reactivates the adhesive in your decal when it cures. Environmentally friendly and comes in a convenient push pump 2 oz. recyclable bottle.

DESCRIPTION	PART #	MFG #		
2 oz bottle	HL964	964	5.95	L

STICKER-OFF!



Sticker-Off! takes the frustration away from decal removal. No more sticky residue left to mess up your new decals. Remove old decal adhesive easily. Works on any decal adhesive, registration numbers, sponsorship decals, number plate backgrounds, racing numbers, graphic kits, OEM decals and much more. Simply apply Sticker-off! onto adhesive residue, let it soften the residue for a minute and then wipe with a clean dry soft cloth. Sticker-off! is environmentally friendly and comes in a convenient push pump 2 oz. recyclable bottle.

DESCRIPTION	PART #	MFG #		
2 oz bottle	HL965	965	5.95	L

TREAD DOCTOR™

Tread Doctor Knobby Cutting Tool™ New Traction on Worn Tires!

Lightweight heated tool cuts new edges into your dull worn out knobby tires. Refresh your front or rear tire before installing a new one. Extends the life of your tire and gives you optimal tire performance throughout the life of your tires. Tread Doctor™ uses a specially designed heated carbide cutting blade to trim your knobby tires. This easy do it yourself tool gives you new traction for every ride! With a little practice you can cut the minimal amount of rubber off each time to get a new edge thus extending the life our your tires and giving you maximum traction for every ride.

- Get more traction for every ride with Tread Doctor!
- Now! Includes new cutting tip
- Use for Motocross, Trail, ATV/UTV, Enduro and Racing
- Use Tread Doctor™ to cut tires for different conditions
- Works on any brand of motorcycle tire
- Unit includes ON/Off Switch and holding stand
- Easily pays for itself with just one tire
- Get the most out of your tires even as they wear
- 100W 110V 50/60Hz
- Meets PSE requirements for Japan
- CE and ROHS certified
- Built to UL standards for design, construction and operation
- All components used exceed industry standard for durability and enhanced functionality

DESCRIPTION	PART #	MFG #		
Tread Doctor™	315001	TD-1	59.95	L



TRAILER

- tires & wheels
- axles, hubs & springs
- tongue accessories
- hitches
- electrical
- brake parts
- trailer hardware
- locks & pins
- towing & loading
- tie downs
- tools
- chemicals



ULTIMATE CORROSION PROTECTION



NEW PRODUCT



Kills existing corrosion and prevents new
Easy and quick to apply
“ACTIVE”
for up to 12 months
Contains no wax, silicone, teflon or water
As close to ZERO CORROSION as nature will allow

Proven chemistry for Powersports. It will make maintenance and cleaning the bike or quad easier and save you money. It will also help prevent surface, structural and electrical corrosion related failure thereby increasing reliability and the bike's/quad's value.

HOW IT WORKS:

ACF-50 chemically treats metal using advanced polar bonding technology. It forms a “hydrophobic” film as it removes moisture from the metal surface. When applied it forms an ‘Active’ ultra-thin clear film that will kill any existing corrosion cells and will protect your bike or quad against new corrosion forming. It contains no water and is approved for electrical switches and connectors. It will create a “water resistant” film in all these parts. ACF-50 has a strong capillary action so will creep into all the areas that moisture can; actively pushing out moisture and replacing it with protection. Use ACF-50 anywhere, except the brakes, on your bike or quad including the engine and exhaust. Safe on paintwork, most rubbers and brings up black plastic trim a treat.

Excellent lubricant and penetrant

Approved for use on electronics and engines

Non-drying, ultra thin, clear film

All year round service spray

Very economical

Protects • Penetrates • Lubricates!



ACF-50 ANTI CORROSION FORMULA

DESCRIPTION	SIZE	PART #	MFG #		
ACF-50 - Liquid	4 ltr / 1.06 Gal	650425	15004	118.50	G
ACF-50 - Aerosol	13 oz	650426	15013	15.75	G
ACF-50 - Liquid Spray Pump	32 oz	650427	15032	36.75	G
ACF-50 - Liquid	20 ltr / 5.28 Gal	650428	15020	486.99	G
Hand Held Spray System	includes 1 bullet tip / 3 wands	650429	50017	525.00	AD

- Forms an “Active” ultra thin, clear film that kills existing corrosion cells, and will protect your quad or bike against new corrosion forming and last for 12 months
- “ACTIVE” which means that it ‘creeps’ and ‘keeps on working’ DOESN’T NEED REAPPLYING AFTER EVERY WASH!
- Contains no water, silicon, teflon or wax - no sticky build up, no risk of existing corrosion being sealed in and no risk of water remaining where it will cause corrosion and damage, even on electronics
- Chemically neutralizes road salt
- A clean, clear ultra thin fluid
- Dries out moisture
- Safe on all components; electronics, chrome, paint and plastic
- Use on heads, cooling fans, throttle linkages, brake cables, battery terminals, voltage regulator, suspension, engine components, torsion bars, fuel control units, fuse box, swingarm, relays / connectors, undercarriage, chain, ignition switch, security systems / FOBs and more!
- ACF-50 can be sprayed on, wiped on with a rag, or professionally fogged for complete protection

TRAILER



CORROSION BLOCK LIQUID • AEROSOL

Kills Corrosion on Contact!

- Protects metal and electronics during play and storage
- Chemically neutralizes salt water
- A clean, clear ultra-thin fluid which leaves a non greasy atmospheric barrier to protect all metal surfaces
- Leaves no gummy residue because it does not contain wax, resin, tar, asphalt, silicone or Teflon
- Can be sprayed, brushed or wiped on
- Hydrophobic film provides corrosion protection all season
- Protects metal components down to -70°
- Keeps ice and mud from sticking
- Combined with its excellent penetrating and strong dielectric properties (40Kv), have brought electronics "back from the dead"
- Removes moisture from the corrosion by-product and isolates it from contacting the metal surface, restoring continuity to electrical circuits
- Can be used in many different electrical and electronic applications without fear of damaging the conformal coatings used
- Does not harm plastics or painted surfaces
- Improves reliability, reduces repair and labor cost

CORROSION BLOCK WATERPROOF GREASE

- Out performs lithium and most synthetic greases and meets or exceeds requirements for NGLI Service Classifications GC-LB (automotive wheel bearing and chassis lubricants) conforming to ATM D4950 performance requirements
- Excellent extreme pressure properties
- Excellent thermal / oxidative stability
- Resists bleeding / melting at high temperatures
- Suitable for sealed for life applications
- Dielectric / non-conductive
- Workplace safe and environmentally friendly
- Out performs competitive grease 5:1
- Waterproof

Prevention is better than replacement!

Corrosion Block is a unique product that has the ability to both prevent and stop corrosion in more places on Powersports Equipment than any other product of its type.

Corrosion Block is superior anti-corrosion compound. It kills corrosion in progress, prevents new corrosion cells from forming for 12-18 months, is an excellent penetrant and is an excellent light lubricant.



DESCRIPTION	SIZE	PART #	MFG #		
Corrosion Block - Liquid	4 ltr / 1.06 Gal	650417	20004	112.95	G
Corrosion Block - Aerosol	12 oz	650418	20012	14.65	B
Corrosion Block - Liquid	32 oz	650419	20032	34.95	D
Corrosion Block - Liquid	20 liter / 5.28 Gal	650420	20020	430.00	B
Corrosion Block Grease	2 oz Tube	650421	25002	5.25	G
Corrosion Block Grease	3 oz Cartridge	650422	25003	7.85	AE
Corrosion Block Grease	14 oz Cartridge	650423	25014	9.95	B
Corrosion Block Grease	16 oz Tub	650424	25016	11.05	G

- tires & wheels
- axles, hubs & springs
- tongue accessories
- hitches
- electrical
- brake parts
- trailer hardware
- locks & pins
- towing & loading
- tie downs
- tools
- chemicals

TRAILER

- tires & wheels
- axles, hubs & springs
- tongue accessories
- hitches
- electrical
- brake parts
- trailer hardware
- locks & pins
- towing & loading
- tie downs
- tools
- chemicals

LIQUID PERFORMANCE



LP PREMIUM BRAKE & PARTS CLEANER

Liquid Performance Premium Brake & Parts Contact Cleaner is a concentrated blend of solvents with a powerful blasting spray that effectively removes grease, grime, brake fluid and other contaminants from brake components and other metal parts without the need for disassembly. This ideal brake and parts cleaner evaporates instantly and completely leaving no residue to hinder performance. Contains no ozone depleters.



DESCRIPTION	QTY/CS	PART #	MFG #		
14 oz	12	650192	0230	6.99	H



BIKE SPIRITS

CONTACT BRAKE CLEANER Quick-Drying Solvent Leaves No Residue

- Non-Chlorinated
- Removes Grease, Oil, Road Grime, Brake Fluid & Chain Lube Overspray
- Instant Evaporation
- OTC/LADCO VOC Compliant



DESCRIPTION	QTY/CS	PART #	MFG #		
14 oz, Sold Each	12	650623	1037677	6.50	G



HIGH LIFTER PRO SERIES TIRE SEALANT

- Protect your tires with the industry-leading tire sealant!
- Seals punctures up to 1/2" in the tread.
- Seals punctures up to 1/4" in the sidewall.

254070	16.95	B
--------	-------	---



HYDRO TURF CONTACT CEMENT

16 oz can liquid contact cement. Great for all your Hydro-Turf mat applications!



DESCRIPTION	PART #	MFG #		
16 oz Dap Weldwood	967168	CC20	14.00	E



SPI DISPOSABLE NITRILE GLOVES

- 100 count box
- Powdered blue



DESCRIPTION	PART #	MFG #		
Small, 100 Count Box	62274	IN-12274	18.95	L
Medium, 100 Count Box	62275	IN-12275	18.95	L
Large, 100 Count Box	62276	UP-12066-3	17.95	L
X-Large, 100 Count Box	62277	UP-12066-4	17.95	L



1-9 B

12V Outlets	
Buyers	148
Optronics	148
SPI.....	284
4-Way Connectors	
Hopkins	134-135
Wes Barg.....	116
4-Way Wire Kits	
Hopkins	122-125
5-Way Connectors	
Hopkins	136
Tow Ready.....	115
Wes Barg.....	115
6-Way Connectors	
Hopkins	133
Wes Barg.....	111
7-Way Connectors	
Hopkins	133
7-Way RV Blade Connectors	
Hopkins	119
Wes Barg.....	111

A

ACF-50	
Corrosion Protection.....	324
Adhesives	
JB Weld	306-309
Three bond.....	302-305
Adjustable Ball Mount	
Buyers	66
Trimax.....	61
A-Frame Jack	
Bulldog	45-46
Buyers	43
Air Tank	
Performance Tool.....	254
Allen Wrenches	
Performance Tool.....	265-266
American Manufacturing	
Trailer Clamp	214
American Tire & Wheel	
Wheel	9
Ancra	
Tie Down Straps.....	224-225
Axle Hanger Kits	
Reliable	37
Axle Tie Plates	
Smith	33-34
Tie Down	33-34
Axles, Round	
Reliable	18
Axles, Torsion	
Reliable	18

Backup Camera	
Hopkins	126-128
Hopkins	145
Ball Mounts	
Buyers	62-64
Draw-Tite.....	62
Wes Barg.....	63
Bearing And Cup Packaged	
Universal.....	28
Bearing Buddy	
Bearing Protector Covers	26
Bearing Protectors.....	26
Bearing Grease	
Lubrimatic.....	38
Bearing Kits	
.....	28
Bearing Protector Covers	
Bearing Buddy.....	26
Tie Down	27
Bearing Protectors	
Bearing Buddy.....	26
Fulton	26
Tie Down	27
Bearing Race Set	
Performance Tool.....	275
Bel-Ray	
Grease.....	301
Parts Cleaner	300
Bike Spirits	
Parts Cleaner	326
Bit Sets	
Performance Tool.....	265
Blazer	
Lights, Submersible	89
Lights, Turn	88-90
Lights, Utility	91
Bleeders	
Motion Pro	287
Box Cutter	
Performance Tool.....	270
Brake Control Harness	
Reese.....	157-159
Tekonsha	157-159
Brake Controls	
Draw-Tite.....	155-156
Hopkins	163-165
Reese.....	154
Tekonsha	151-153
Brake Drum Parts	
Reliable	176
Brake Drum Assemblies	
Tekonsha	168-174
Brake Drum Parts	
Tekonsha	168-175
Tie Down	176
Break-Away Systems	
Hopkins	166
Tekonsha	161-162
Bronco	
Tire Repair Kit	251

Bulldog	
A-Frame Jack	45-46
Electric Jack	44
Jack Parts	47-48
Receiver Locks	195
Square Jack.....	45
Swivel Jack.....	46
Bumper Guards	
Tow Ready.....	54
Bunge Cord	
Erickson.....	236-237
Highland	247-248
Bunk Boards	
Shipsshape	221-222
Bunk Brackets	
Smith	220
Bunk Carpet	
Smith	221
Bunk Wrap	
Caliber	207
Buyers	
12V Outlets.....	148
Adjustable Ball Mount.....	66
A-Frame Jack	43
Ball Mounts.....	62-64
Coupler Repair Kits	52
Couplers	50-52
Double Ball Mount	64-65
Drawbar.....	74-75
Electric Jack	42
E-Track	182
E-Track Straps.....	182
Hinges	180
Hitch Balls	56
Hitch Pins	197-198
Latches.....	180
Lights, Back-Up	78
Lights, Flashing	109
Lights, Magnetic	110
Lights, Turn	78-79
Lights, Utility	78
Lynch Pins	197
Pintle Hooks	71-73
Ramp Plates.....	205
Receiver Adapter.....	68
Receiver Hook	70
Receiver Locks	194
Receiver Step	67
Receiver Tubes.....	67
Ring Anchors.....	178-179
Safety Chains	57
Shackles.....	181
Square Jack.....	43
Swivel Jack.....	43
Tie Down Straps.....	241
Tool Boxes	49
Trailer Steps	49
Trailer Winches	216
Tri-Ball Mount	65-66
Wheel Chocks	15

C

Caliber	
Bunk Wrap.....	207
Marine Slides.....	207
Ramp Glides.....	212
Ring Anchors.....	212
Salt Shields.....	211
Traction Pads.....	210
Trailer Glides.....	208-209
Trailer Props.....	206
Calipers	
Performance Tool.....	274
Cargo Bar	
Erickson.....	180
Erickson.....	239
Carlisle	
Tire Tubes.....	11
Tires.....	10
Wheel Assemblies.....	6-8
Carriers	
Tie Down.....	76
C-Clamp	
Performance Tool.....	268
Cipa	
Tow Mirrors.....	200-201
Cleaner	
Hardline.....	323
Combo Wrench Set	
Performance Tool.....	270
Compression Testers	
Motion Pro.....	286
Performance Tool.....	285
Cone Bearings	
Universal.....	27
Connector Adapters	
Hopkins.....	117-121
Reese.....	114
Connector Brackets	
Tow Ready.....	112-113
Wes Barg.....	112
Connectors, Vehicle Specific	
Draw-Tite.....	147
Hopkins.....	140-144
Contact Cement	
Hydro-Turf.....	326
Convert-A-Ball	
Convertible Hitch Ball.....	59-60
Convertible Hitch Ball	
Convert-A-Ball.....	59-60
Tow Ready.....	61
Corrosion Block	
Corrosion Protection.....	325
Corrosion Protection	
ACF-50.....	324
Corrosion Block.....	325
Coupler Locks	
Tow Ready.....	196
Trimax.....	188
Coupler Repair Kits	
Buyers.....	52
Couplers	
Buyers.....	50-52
Fulton.....	50-52

D

Deadbolt	
Receiver Locks.....	195
Degreaser	
Permatex.....	315
Disc Brake Kits	
Tie Down.....	174
Double Ball Mount	
Buyers.....	64-65
Drawbar	
Buyers.....	74-75
Drawbar Kits	
Draw-Tite.....	61
Draw-Tite	
Ball Mounts.....	62
Brake Controls.....	155-156
Connectors, Vehicle Specific.....	147
Drawbar Kits.....	61
Receiver Covers.....	69
Taillight Converters.....	147

E

Earmuffs	
Elvex.....	276
Electric Jack	
Bulldog.....	44
Buyers.....	42
Fulton.....	40
Electric Tire Pump	
Performance Tool.....	16
Elvex	
Earmuffs.....	276
Protective Eyewear.....	276
Enforcer	
Trailer Props.....	206
Equalizers	
Universal.....	25
Erickson	
Bunge Cord.....	236-237
Cargo Bar.....	180, 239
E-Track.....	182
E-Track Straps.....	182, 240
Ramp Plates.....	205
Ring Anchors.....	178-179
Tarps.....	297
Tie Down Straps.....	226-236
Tow Rope.....	233
Winch Straps.....	217, 237
E-Track	
Buyers.....	182
Erickson.....	182
E-Track Straps	
Buyers.....	182
Erickson.....	182, 240
Extractor Set	
Performance Tool.....	272

F

Fender Brackets	
Smith.....	13
Tie Down.....	13
Flashlights	
Performance Tool.....	273
Flexride	
Universal.....	19
Flywheel Puller	
Snostuff.....	283
Fold-Away Hinges	
Fulton.....	52
Frame Straps	
Smith.....	35
Tie Down.....	35
Fuel Line Clamps	
Motion Pro.....	287
Fulton	
Bearing Protectors.....	26
Couplers.....	50-52
Electric Jack.....	40
Fold-Away Hinges.....	52
Plastic Fenders.....	12-13
Receiver Locks.....	194
Spare Tire Carrier.....	14
Swivel Jack.....	41
Tongue Jack.....	40-41
Trailer Winches.....	215-216
Funnels	
.....	292-295
Fuses	
Performance Tool.....	275

G

Gear Pullers	
Performance Tool.....	283
Grease	
Bel-Ray.....	301
Lubrimatic.....	313-314
Maxima.....	318
Grease Gun	
Lubrimatic.....	38
Performance Tool.....	38, 321
Grease Gun Accessories	
Performance Tool.....	255-256
Grease Seals	
Martin Wheel.....	28

H

Hair Pins	
Pivot Point.....	198
Hammer	
Performance Tool.....	266
Hardline	
Cleaner.....	323
Hitch Camera.....	55
Hour Meters.....	296
Hardware Assortments	
Performance Tool.....	288
Hex Key Set	
Performance Tool.....	265-266
High Lifter	
Tire Sealant.....	326
Highland	
Bunge Cord.....	247-248
Tie Down Straps.....	243-247
Highland Ramp Parts	
Loading Ramps.....	204
Hinges	
Buyers.....	180
Hitch Alignment System	
Tow Ready.....	15
Hitch Balls	
Buyers.....	56
Tow Ready.....	56
Trimax.....	54
Hitch Camera	
Hardline.....	55
Hitch Pins	
Buyers.....	197-198
Trimax.....	198

Hitch Wrench

Reese.....	54
------------	----

Hopkins

4-Way Connectors.....	134-135
4-Way Wire Kits.....	122-125
5-Way Connectors.....	136
6-Way Connectors.....	133
7-Way Connectors.....	133
7-Way RV Blade Connectors....	119
Backup Camera.....	126-128, 145
Brake Controls.....	163-165
Break-Away Systems.....	166
Connector Adapters.....	117-121
Connectors, Vehicle Specific.....	140-144
Multi-Tow Kits.....	129-132
Taillight Converters.....	139
Trailer Wire.....	138
Wire Installation Kits.....	138

Hour Meters

Hardline.....	296
Wiseco.....	296

Hub Kits

Reliable.....	20
Shipshape.....	20
Turbo Lube.....	20

Hydro-Turf

Contact Cement.....	326
Oil Extractor.....	257

I

Ignition Tester	
Performance Tool.....	281
Ipone	
Parts Cleaner	319

J

J D Russell	
Traction Pads.....	205
Jack	
Performance Tool.....	254
Jack Parts	
Bulldog	47-48
Jack Stands	
Performance Tool.....	254
JB Weld	
Adhesives.....	306-309
RTV Sealant	310-311
Thread Lock	312
Juice	
Jumper Cables	282
Jumper Cables	
Juice	282
Motion Pro.....	282

K

Keel Roller	
Smith	219
Keel Roller Assembly	
Smith	218

L

Latches	
Buyers	180
Leaf Springs	
Universal.....	23-24
License Plate Brackets	
Optronics	103
Peterson	103
Light Grommet	
Peterson	97
Light Wire	
Peterson	97
Lights, Back-Up	
Buyers	78
Peterson	95
Lights, Flashing	
Buyers	109
Peterson	109
Lights, Fog	
Optronics	104
Peterson	104
Lights, Lens	
Peterson	92
Lights, Magnetic	
Buyers	110
Peterson	110
Lights, Marker	
Optronics	80-86
Peterson	94-96
Wes Barg.....	99
Lights, Mounting Bracket	
Peterson	93
Lights, Plate	
Optronics	103
Peterson	103
Lights, Submersible	
Blazer	89
Optronics	81-83
Peterson	92
Wes Barg.....	98-102
Lights, Turn	
Blazer	88-90
Buyers	78-79
Optronics	87
Peterson	93-94
Lights, Utility	
Blazer	91
Buyers	78
Optronics	107
Peterson	106-107
Wes Barg.....	105
Liquid Performance	
Parts Cleaner	326
Load Star	
Tires	10
Wheel Assemblies.....	6-8
Loading Ramps	
.....	202-204
Highland Ramp Parts	204
Lock Cables	
Tow Ready.....	196
Trimax.....	190-192
Lock Kits, Keyed Alike	
Trimax.....	188
Lubrimatic	
Bearing Grease	38
Grease.....	313-314
Grease Gun.....	38
Lug Wrench	
Performance Tool.....	16
Lynch Pins	
Buyers	197
Pivot Point	197

M

Magnet Kits	
Tekonsha	167
Magnetic Retriever	
Performance Tool	279
Mallets	
Performance Tool	266
Marine Slides	
Caliber	207
Martin Wheel	
Grease Seals	28
Maxima	
Grease	318
Parts Cleaner	318
Metal Fenders	
Smith	13
Motion Pro	
Bleeders	287
Compression Testers	286
Fuel Line Clamps	287
Jumper Cables	282
Spring Tool	281
Tire Gauges	250-251
Tire Repair Kit	251
Wrenches	258-259
Mtec	
Spring Sliders	36
Multimeter	
Performance Tool	280
Multi-Tow Kits	
Hopkins	129-132

O

Oil Extractor	
Hydro-Turf	257
Oil Filter Wrench	
Performance Tool	267
Optronics	
12V Outlets	148
License Plate Brackets	103
Lights, Fog	104
Lights, Marker	80-86
Lights, Plate	103
Lights, Submersible	81-83
Lights, Turn	87
Lights, Utility	107
Reflectors	102

P

Padlocks	
Trimax	193
Parts Cleaner	
Bel-Ray	300
Bike Spirits	326
Ipone	319
Liquid Performance	326
Maxima	318
Permatex	315
PJ1	320
Performance Tool	
Air Tank	254
Allen Wrenches	265-266
Bearing Race Set	275
Bit Sets	265
Box Cutter	270
Calipers	274
C-Clamp	268
Combo Wrench Set	270
Compression Testers	285
Electric Tire Pump	16
Extractor Set	272
Flashlights	273
Fuses	275
Gear Pullers	283
Grease Gun	38, 321
Grease Gun Accessories	255-256
Hammer	266
Hardware Assortments	288
Hex Key Set	265-266
Ignition Tester	281
Jack	254
Jack Stands	254
Lug Wrench	16
Magnetic Retriever	279
Mallets	266
Multimeter	280
Oil Filter Wrench	267
Pick Set	271
Plastic Creeper	257
Pliers	266-267
Protective Eyewear	276
Ratchet Wrench	260-264
Riveter	279
Scraper	271
Screwdrivers	269
Siphon	257
Snap Ring Pliers	279
Sockets	260-264
Spark Plug Gap Tester	275
Spotlights	272
Spring Tool	281
Step Drill Set	271
Tap Die Set	272
Tie Down Straps	242
Tire Gauges	16, 253
Tire Repair Kit	252
Torque Wrench	270
Utility Knife	270
Wire Brush	278
Wire Crimpers	268

Permatex	
Degreaser	315
Parts Cleaner	315
RTV Sealant	317
Thread Lock	317
Peterson	
License Plate Brackets	103
Light Grommet	97
Light Wire	97
Lights, Back-Up	95
Lights, Flashing	109
Lights, Fog	104
Lights, Lens	92
Lights, Magnetic	110
Lights, Marker	94-96
Lights, Mounting Bracket	93
Lights, Plate	103
Lights, Submersible	92
Lights, Turn	93-94
Lights, Utility	106-107
Pick Set	
Performance Tool	271
Pintle Hooks	
Buyers	71-73
Pivot Point	
Hair Pins	198
Lynch Pins	197
Pj1	
Parts Cleaner	320
Plastic Creeper	
Performance Tool	257
Plastic Fenders	
Fulton	12-13
Tie Down	12-13
Pliers	
Performance Tool	266-267
Protective Eyewear	
.....	277
Elvex	276
Performance Tool	276

R

S

Ramp Glides	
Caliber	212
Ramp Plates	
Buyers	205
Erickson	205
Ratchet Wrench	
Performance Tool	260-264
Receiver Adapter	
Buyers	68
Receiver Covers	
Draw-Tite	69
Receiver Hook	
Buyers	70
Receiver Locks	
Bulldog	195
Buyers	194
Deadbolt	195
Fulton	194
Tow Ready	196
Trimax	184-187
Receiver Step	
Buyers	67
Receiver Tubes	
Buyers	67
Reese	
Brake Control Harness	157-159
Brake Controls	154
Connector Adapters	114
Hitch Wrench	54
Reflectors	
Optronics	102
Reliable	
Axle Hanger Kits	37
Axles, Round	18
Axles, Torsion	18
Brake Drum Parts	176
Hub Kits	20
Spindle Kits	28
Spindle Parts	19
Spindles	22
U-Bolt Kits	32
U-Bolts	32
Wheel Bolts	21
Ride-On	
Smart Tire Caps	322
Tire Sealant	322
Ring Anchors	
Buyers	178-179
Caliber	212
Erickson	178-179
Riveter	
Performance Tool	279
Rtv Sealant	
JB Weld	310-311
Permatex	317
Three bond	302

Safety Cables	
Tie Down	58
Safety Chains	
Buyers	57
Smith	57
Tie Down	58
Safety Hooks	
Smith	57
Tie Down	58
Salt Shields	
Caliber	211
Scraper	
Performance Tool	271
Screwdrivers	
Performance Tool	269
Shackle Bolts	
Smith	36
Shackles	
Buyers	181
Shipshape	
Bunk Boards	221-222
Hub Kits	20
Siphon	
Performance Tool	257
Ski Protectors	
.....	214
Smart Tire Caps	
Ride-On	322
Smith	
Axle Tie Plates	33-34
Bunk Brackets	220
Bunk Carpet	221
Fender Brackets	13
Frame Straps	35
Keel Roller Assembly	218
Metal Fenders	13
Safety Chains	57
Safety Hooks	57
Shackle Bolts	36
Spare Tire Carrier	14
Spare Tire Covers	15
Spindle Parts	18
U-Bolts	31
Smith	
Keel Roller	219
Snap Ring Pliers	
Performance Tool	279
Snostuff	
Flywheel Puller	283
Sockets	
Performance Tool	260-264
Spare Tire Carrier	
Fulton	14
Smith	14

Spare Tire Covers	
Smith	15
Spark Plug Gap Tester	
Performance Tool	275
SPI	
12V Outlets	284
Spring Tool	281
Spindle Kits	
Reliable	28
Spindle Parts	
Reliable	19
Smith	18
Spindles	
Reliable	22
Tie Down	22
Spotlights	
Performance Tool	272
Spring Bushings	
Universal	25
Spring Sliders	
Mtec	36
Spring Tool	
Motion Pro	281
Performance Tool	281
SPI	281
Square Jack	
Bulldog	45
Buyers	43
Step Drill Set	
Performance Tool	271
Suspa	
Trailer Props	206
Swivel Jack	
Bulldog	46
Buyers	43
Fulton	41



- Taillight Converters**
 Draw-Tite 147
 Hopkins 139
- Tap Die Set**
 Performance Tool..... 272
- Tarps**
 Erickson..... 297
- Tekonsha**
 Brake Control Harness 157-159
 Brake Controls..... 151-153
 Brake Drum Assemblies..... 168-174
 Brake Drum Parts..... 168-175
 Break-Away Systems..... 161-162
 Magnet Kits 167
- Thread Doctor**
 Thread Doctor 323
 Thread Doctor 323
- Thread Lock**
 JB Weld 312
 Permatex 317
 Three bond..... 305
- Three bond**
 Adhesives 302-305
 RTV Sealant 302
 Thread Lock 305
- Tie Down**
 Axle Tie Plates..... 33-34
 Bearing Protector Covers 27
 Bearing Protectors..... 27
 Brake Drum Parts 176
 Carriers..... 76
 Disc Brake Kits 174
 Fender Brackets 13
 Frame Straps..... 35
 Plastic Fenders..... 12-13
 Safety Cables 58
 Safety Chains 58
 Safety Hooks 58
 Spindles..... 22
 U-Bolts..... 29-31
- Winch Cable 217
 Winch Mounting Plate 59
 Winch Straps 217
- Tie Down Straps**
 Ancra 224-225
 Buyers 241
 Erickson..... 226-236
 Highland 243-247
 Performance Tool..... 242
- Tire Gauges**
 Motion Pro 250-251
 Performance Tool..... 16, 253
- Tire Repair Kit**
 Bronco 251
 Motion Pro 251
 Performance Tool..... 252
- Tire Sealant**
 High Lifter 326
 Ride-On 322
- Tire Tubes**
 Carlisle 11
- Tires**
 Carlisle 10
 Load Star..... 10
- Tongue Jack**
 Fulton 40-41
- Tool Boxes**
 Buyers 49
- Torque Wrench**
 Performance Tool..... 270
- Tow Mirrors**
 Cipa 200-201
- Tow Ready**
 5-Way Connectors 115
 Bumper Guards 54
 Connector Brackets 112-113
 Convertible Hitch Ball 61
 Coupler Locks 196
 Hitch Alignment System 15
 Hitch Balls 56
 Lock Cables..... 196
 Receiver Locks 196
- Tow Rope**
 Erickson..... 233
- Track Anchors**
 213
- Traction Pads**
 Caliber 210
 J D Russell 205
- Trailer Clamp**
 213
 American Manufacturing 214
- Trailer Glides**
 213
 Caliber 208-209
- Trailer Lift Arm**
 206
- Trailer Props**
 Caliber 206
 Enforcer 206
 Suspa 206
- Trailer Steps**
 Buyers 49
- Trailer Winches**
 Buyers 216
 Fulton 215-216
- Trailer Wire**
 Hopkins 138
- Tri-Ball Mount**
 Buyers 65-66
- Trimax**
 Adjustable Ball Mount..... 61
 Coupler Locks 188
 Hitch Balls 54
 Hitch Pins 198
 Lock Cables..... 190-192
 Lock Kits, Keyed Alike 188
 Padlocks 193
 Receiver Locks 184-187
 Wheel Locks 15, 189
- Turbo Lube**
 Hub Kits..... 20

U

U-Bolt Kits	
Reliable	32
U-Bolts	
Reliable	32
Smith	31
Tie Down	29-31
Universal	
Bearing And Cup Packaged	28
Cone Bearings.....	27
Equalizers.....	25
Flexride.....	19
Leaf Springs	23-24
Spring Bushings	25
Utility Knife	
Performance Tool.....	270

V

VP	
VP Cans	290-291
VP Cans	
VP	290-291

W

Wes Barg	
4-Way Connectors	116
5-Way Connectors	115
6-Way Connectors	111
7-Way RV Blade Connectors	111
Ball Mounts.....	63
Connector Brackets	112
Lights, Marker	99
Lights, Submersible	98-102
Lights, Utility	105

Wheels	
American Tire & Wheel.....	9
Wheel Assemblies	
Carlisle	6-8
Load Star.....	6-8
Wheel Bolts	
Reliable	21
Wheel Chocks	
Buyers	15
Wheel Locks	
Trimax.....	15, 189
Winch Cable	
Tie Down	217
Winch Mounting Plate	
Tie Down	59
Winch Straps	
Erickson.....	217, 235
Tie Down	217
Wire Brush	
Performance Tool.....	278
Wire Crimpers	
Performance Tool.....	268
Wire Installation Kits	
Hopkins	138
Wiseco	
Hour Meters.....	296
Wrenches	
Motion Pro	258-259